

Transistor Specifications Manual

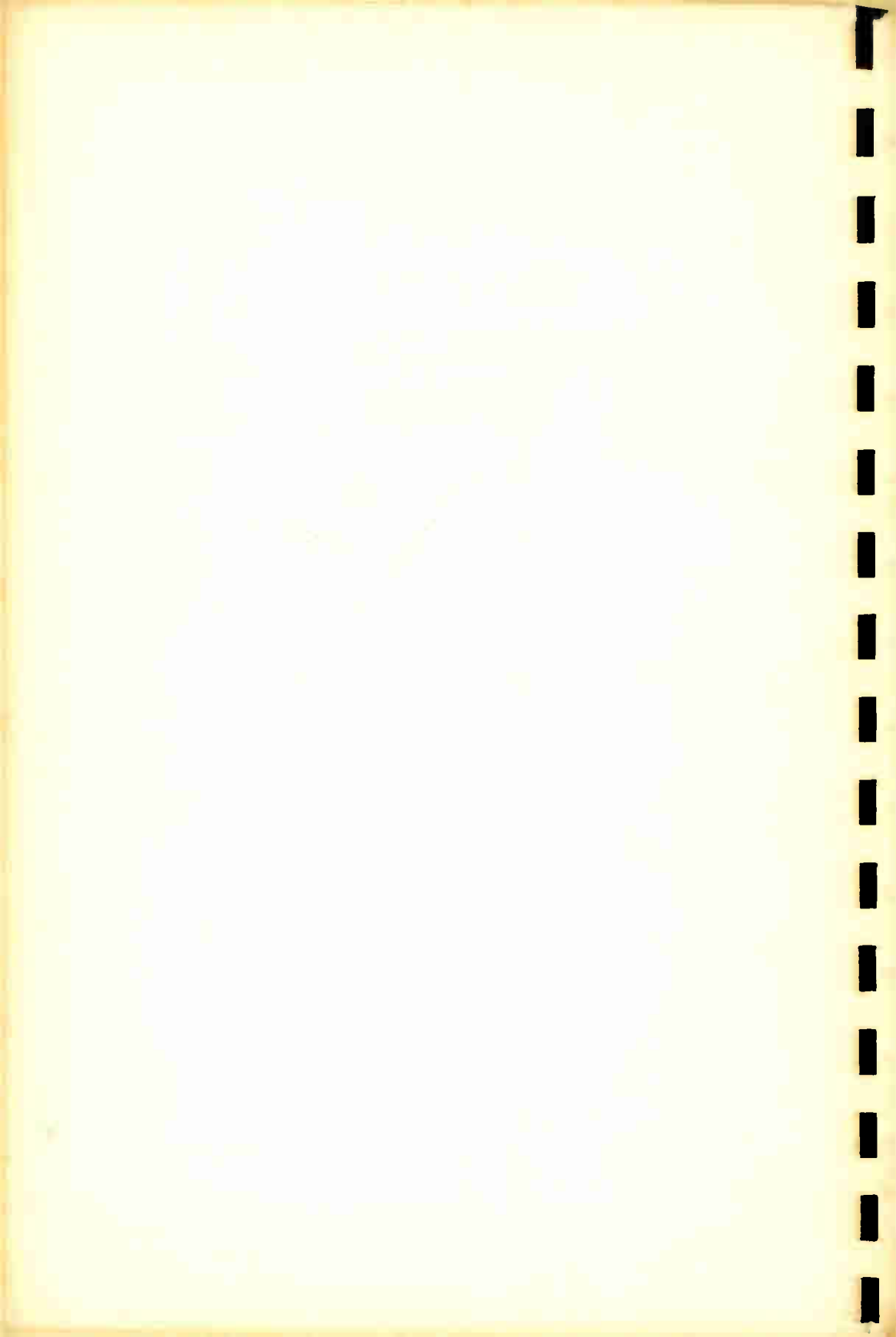



TRANSISTOR SPECIFICATIONS MANUAL

by
The Howard W. Sams
Engineering Staff



HOWARD W. SAMS & CO., INC.
THE BOBBS-MERRILL CO., INC.
INDIANAPOLIS · KANSAS CITY · NEW YORK

FOURTH EDITION
FIRST PRINTING — 1970

Copyright© 1964, 1967, 1968, and 1970 by Howard W. Sams & Co., Inc., Indianapolis, Indiana 46206. Printed in the United States of America.

All rights reserved. Reproduction or use, without express permission, of editorial or pictorial content, in any manner, is prohibited. No patent liability is assumed with respect to the use of the information contained herein. While every precaution has been taken in the preparation of this book the publisher assumes no responsibility for errors or omissions. Neither is any liability assumed for damages resulting from use of the information contained herein.

Library of Congress Catalog Card Number: 70-122964

Preface

In the time since the first transistors were made available, the total number of types has increased tremendously. Many of these transistors are no longer on the market; many were produced with no type numbers and others by manufacturers no longer producing transistors. When these types are encountered in older equipment, it is usually difficult, if not impossible, to locate transistor specifications. There is one redeeming factor in all of this confusion: the fact that in most cases a transistor can be chosen to replace one of these obsolete types by estimating voltage, current, wattage, and frequency response and then selecting a transistor from the types available.

This manual contains three principal sections designed to provide a maximum of information about the transistor: a specifications section, a lead identification section, and an outlines section. The specification section is composed of the electrical data that will be required for most applications. These are voltage, power, current, and temperature limits that should not be exceeded, as well as polarity, leakage, gain, and frequency parameters that determine how the transistor will function in the circuit. The manufacturers of the transistor are listed to provide a market-source for the units and to act as a guide to obtain further information. Reference numbers are supplied in this section to key the transistor type to the associated Lead and Terminal Identification section and to the Outlines section.

The Lead and Terminal Identification section supplies the physical arrangement of the leads and identifies each as to whether it is collector, emitter, or base. The Outlines section contains drawings of the physical shape and includes all pertinent physical dimensions. This section is of considerable help in determining whether a transistor will fit into a desired physical area.

An interesting aspect of transistors is the wide range of physical sizes. Transistor sizes range from pin-head to golf-ball dimensions, and the wattage and current ratings do not always reflect this size. For example, there are transistors in TO-46 cases (0.23 inch in diameter, 0.09 inch high) that are rated at 5 watts. This, of course, assumes that the temperature of the case will be maintained at 25°C by means of a suitable heat sink. Among the types with higher ratings (up to 150 watts) are those in TO-82 cases (1.28 inches in diameter by 0.55 inch high).

For additional information about a particular section of this manual, refer to the introduction at the beginning of each section. Page numbers are listed on the Contents page.

In this specifications manual we have attempted to supply the essential electrical and physical data needed by anyone working with transistors.





Contents

Key to Transistor Specifications	6
Transistor Specifications	7
R-F Power Transistor Specifications	94
Key to R-F Power Transistors	95
Registered Transistor Outlines	96
Transistor Outlines	160
Lead and Terminal Identification	182
Key to Manufacturers	192

Transistor Type No.	N P	C S	Manufacturer	Lead (Ident)	Out-line	Maximum (V)			Maximum		Max. T.(°C)	Frequency Resp.(MHz)	Leakage		Gain	
						V _{CE}	V _{BE}	V _{ES}	I _c	Power			I _{CE0} @ V _{CE}	I _{ES} @ I _c		
+ See Below																
<p>- = Obsolete N = NPN P = PNP G = Germanium S = Silicon</p>			<p>Typical value of current gain for common emitter configuration at current shown.</p> <p>Current between collector and base with the emitter open, at voltage shown.</p> <p>MA = milliamperes. IA = microamperes. NA = nanoamperes.</p>													
<p>Key to Manufacturers Page 192. M. P. - 2N224 = a matched pair of 2N224's. SEE 2N_____ = Cross reference from an obsolete type to one with equal or higher specifications.</p>			<p>Frequency in megahertz. Transistor will operate at this frequency or higher.</p> <p>B = f_{ab} (common base cutoff frequency) E = f_{ae} (common emitter cutoff frequency) G = f_t (gain-bandwidth product) F = f_{osc} (maximum frequency of oscillation)</p>													
<p>Numbers refer to <u>Lead and Terminal Identification</u> Page 182.</p>			<p>Abbreviations when type of service is indicated:</p> <p>AUO = Audio CON = Converter HF = High Frequency HS = High Speed LS = Low to Medium Speed MS = Medium Speed SW = Switch VIO = Video</p>													
<p>TO numbers refer to <u>Registered Transistor Outlines</u> Page 96. Other numbers refer to <u>Transistor Outlines</u> Page 160.</p>			<p>Maximum operating temperature (°C) A = Ambient C = Case J = Junction</p>													
<p>Maximum voltages that cannot be exceeded without permanent damage to the transistor.</p> <p>V_{CB} = Collector-to-base voltage with emitter open. V_{CE} = Collector-to-emitter voltage (base open, if no subscript indicated. R = Resistor between emitter and base. S = Short between emitter and base. X = B-E junction forward biased. V_{EB} = Emitter-to-base reverse voltage with collector open.</p>			<p>Maximum power that can be dissipated at 25° C ambient for low-power types, or 25° case temperature for high-power types.</p>													
			<p>Maximum continuous collector current.</p>													

+ Type with same number but slightly different specifications (usually case style)

Transistor Type No.	N P S	G S	Manufacturer	Lead Ident	Out. line	Maximum (V)			Maximum		Max. T.(°C)	Frequency Resp.(MHz)	Leakage		Gain h _{FE} @ I _C	
						V _{CE}	V _{BE}	V _{ES}	I _C	Power			I _{CEO} @ V _{CE}	I _{CE}		
2A	-	P	CLE	1	1A	50		50.0	.008A	.120W	50A	AUD	2MA	40V	3	
2B	-	P	SEE													
2C	-	P	CLE	11	1A	50		50.0	.008A	.120W	50A	2.000B	1MA	15V	3	
2D	-	P	CLE	1	1A	50		50.0	.008A	.120W	50A	2.000B	1MA	40V	3	
2E	-	P	CLE	1	1A	50		50.0	.008A	.120W	50A	AUD	1MA	40V	3	
2F	-	P	CLE	1	1A	50		50.0	.008A	.120W	50A	5.000B	1MA	15V	3	
2G	-	P	CLE	1	1A	50		50.0	.008A	.120W	50A	10.000B	1MA	15V	3	
2N34	-	P	GEC	210	TO 5	40		25R	.100A	.150W	75J	.500B	50UA	40V	.001A	
2N34+	-	P	RCA	210	TO 22	40		25	.100A	.150W	75J	.400G	50UA	40V	.001A	
2N34A	-	P	ETC	210	TO 5	40		25R	.100A	.150W	75J	.600B	100UA	40V	.001A	
2N35	-	N	GEC	210	TO 5	40		25R	.100A	.150W	85J	1.000B	50UA	40V	.001A	
2N35+	-	N	SYL	10	TO 22	40		10.0	.100A	.180W	85J	.200G	50UA	40V	70	
2N36	-	P	GEC	210	TO 5	20		20	.008A	.050W	75J	AUD	10UA	20V	50	
2N36+	-	P	CBS	210	TO 10E	20		20	.008A	.050W	50A	AUD	10UA	20V	50	
2N37	-	P	GEC	210	TO 5	20		20	.008A	.050W	75J	AUD	10UA	20V	30	
2N38	-	P	GEC	210	TO 5	20		20	.008A	.050W	50A	AUD	10UA	20V	20	
2N38+	-	P	CBS	10	TO 10E	20		20	.008A	.050W	50A	AUD	10UA	20V	16	
2N43	-	P	GEC	210	TO 5	45		30R 5.0	.300A	.240W	85J	1.300B	16UA	45V	40	
2N43+	-	P	GEC	57	57B	45		30	.300A	.500W	50A	.500G	16UA	45V	44	
2N43A	-	P	GEC	210	TO 5	45		30R 5.0	.300A	.240W	85J	1.300B	16UA	45V	40	
2N43A+	-	P	GEC	57	57B	45		30R 5.0	.300A	.240W	85J	1.300B	16UA	45V	40	
2N44	-	P	GEC	210	TO 5	45		30R 5.0	.300A	.240W	85J	1.000B	16UA	45V	30	
2N44+	-	P	GEC	57	57B	45		30R 5.0	.300A	.240W	85J	.500G	16UA	45V	30	
2N44A	-	P	GEC	210	TO 5	45		30R 5.0	.300A	.240W	85J	1.000B	15UA	45V	30	
2N45	-	P	GEC	210	TO 5	45		30	.010A	.150W	85J	1.000B	15UA	45V	16	
2N45+	-	P	GEC	57	57B	45		30	.050A	.150W	100J	.500B	15UA	15V	15	
2N45A	-	P	GEC	210	TO 5	45		5.0	.010A	.150W	85J	1.000B	15UA	15V	22	
2N52	-	P	CLE	210	TO 1A	50		50.0	.008A	.120W	50A	2.000B	2MA	40V	.001A	
2N59	-	N	GEC	210	TO 5	25		20	.200A	.180W	85J	.900B	15UA	20V	90	
2N59A	-	P	GEC	210	TO 5	40		20	.200A	.180W	85J	1.800B	15UA	20V	90	
2N59B	-	P	GEC	210	TO 5	50		20	.200A	.180W	85J	1.800B	15UA	20V	90	
2N59C	-	P	GEC	210	TO 5	50		20	.200A	.180W	85J	1.800B	15UA	20V	90	
2N60	-	P	GEC	210	TO 5	25		20	.200A	.180W	85J	1.500B	15UA	20V	70	
2N60A	-	P	GEC	210	TO 5	40		20	.200A	.180W	85J	1.500B	15UA	20V	70	
2N60B	-	P	GEC	210	TO 5	50		20	.200A	.180W	85J	1.500B	15UA	20V	70	
2N60C	-	P	GEC	210	TO 5	60		20	.200A	.180W	85J	1.500B	15UA	20V	70	
2N61	-	P	GEC	210	TO 5	60		20	.200A	.180W	85J	1.000B	15UA	20V	38	
2N61A	-	P	GEC	210	TO 5	40		20	.200A	.180W	85J	1.000B	15UA	20V	50	
2N61B	-	P	GEC	210	TO 5	50		20	.200A	.180W	85J	1.000B	15UA	20V	50	
2N61C	-	P	GEC	210	TO 5	60		20	.200A	.180W	85J	1.000B	15UA	20V	50	
2N63	-	P	GEC	210	TO 5	25		6.0	.020A	.125W	85J	.500B	6UA	6V	22	
2N63+	-	P	RAY	210	TO 10A	25		6.0	.010A	.100W	85A	.600B	6UA	6V	22	
2N64	-	P	GEC	210	TO 5	25		6.0	.020A	.125W	85J	.700B	6UA	6V	50	
2N64+	-	P	RAY	10	TO 10A	15		6.0	.010A	.100W	85A	.800B	6UA	6V	44	
2N65	-	P	GEC	210	TO 5	25		6.0	.020A	.125W	85J	1.200B	6UA	6V	90	
2N65+	-	P	RAY	210	TO 10A	12		15	.010A	.100W	85A	1.200B	6UA	6V	90	
2N68	-	P	GEC	148	148A	30		15	1.500A	4.000W	75J	5.000B	5MA	15V	40	
2N76	-	P	GEC	57	57B	20		15	.010A	.070W	60J	.500B	10UA	5V	30	
2N77	-	P	GEC	210	TO 5	30		6.0	.035A	.085W	85J	.350B	10UA	12V	60	
2N78	-	N	GEC	210	TO 5	15		15	.020A	.065W	85J	5.000B	3UA	15V	90	
2N78+	-	N	ETC	12	TO 12A	15		15	.020A	.065W	85J	5.000B	3UA	15V	90	
2N78A	-	N	GEC	210	TO 5	20		20	.020A	.065W	85J	5.000B	3UA	15V	90	
2N78A+	-	N	GEC	12	TO 12B	20		20	.020A	.065W	85J	5.000B	3UA	15V	90	
2N83	-	P	GEC	117	117A	66		12.0	2.000A	10.000W	85J	.350B	100UA	25V	18	
2N83A	-	P	GEC	117	117A	66		12.0	3.000A	10.000W	85J	.400B	85UA	25V	18	
2N83B	-	P	GEC	117	117A	50		12.0	4.000A	10.000W	85J	1.100B	15UA	25V	18	
2N84A	-	P	GEC	117	117A	50		12.0	3.000A	10.000W	85J	.400B	95UA	25V	20	
2N94	-	N	GEC	210	TO 5	20		20R 5.0	.100A	.150W	75J	2.000B	10UA	20V	10	
2N94+	-	N	SYL	210	TO 22	20		20R 5.0	.100A	.150W	85J	2.000B	50UA	20V	50	
2N94A	-	N	GEC	210	TO 5	20		20R 5.0	.100A	.150W	85J	5.000B	3UA	10V	50	
2N94A+	-	N	SYL	10	TO 22	20		20R 5.0	.100A	.150W	85J	5.000B	3UA	10V	50	
2N95	-	N	GEC	148	148A	30		15	1.500A	4.000W	75J	5MA	15V	40		
2N97	-	N	GEC	210	TO 5	30		2.5	.010A	.050W	75J	.500B	10UA	5V	14	
2N98	-	N	GEC	210	TO 5	40		2.5	.010A	.050W	75J	.800B	10UA	5V	14	
2N98+	-	N	ETC	210	TO 5	40		2.5	.010A	.050W	75J	2.000B	10UA	5V	40	
2N99	-	N	GEC	148	148B	30		15	1.500A	4.000W	75J	5MA	15V	40		
2N101	-	N	GEC	148	148B	30		15	1.500A	4.000W	75J	5MA	15V	40		
2N101/13	-	P	GEC	430	TO 13	30		15	1.500A	4.000W	75J	5MA	15V	40		
2N102	-	N	SYL	148	148B	30		15	1.500A	4.000W	75J	5MA	15V	40		
2N102/13	-	N	SYL	148	148B	30		15	1.500A	4.000W	75J	5MA	15V	40		
2N103	-	N	GEC	210	TO 5	35		35	2.5	.010A	.050W	75J	.750B	50UA	35V	10
2N104	-	P	GEC	210	TO 5	30		12.0	.050A	.150W	85J	.350B	10UA	12V	44	
2N104+	-	P	RCA	55	TO 40	30		12.0	.050A	.150W	70A	.700B	10UA	12V	44	
2N105	-	P	GEC	210	TO 5	25		6.0	.050A	.060W	85J	.400B	7UA	12V	55	
2N106	-	P	GEC	210	TO 5	10		6	.010A	.100W	85J	1.000B	12UA	6V	38	
2N106+	-	P	RAY	10	TO 10A	6		6	.010A	.100W	85A	.800B	12UA	2V	26	
2N107	-	P	GEC	210	TO 5	12		6	2.0	.010A	.050W	60J	.300B	10UA	12V	30
2N108	-	P	GEC	210	TO 5	20		20	.015A	.050W	60J	AUD	10UA	20V	80	
2N109	-	P	GEC	210	TO 5	25		12.0	.070A	.150W	85J	AUD	14UA	25V	80	
2N109+	-	P	RCA	55	TO 40	25		12.0	.070A	.150W	50A	4.000B	10UA	25V	74	
2N111	-	P	GEC	210	TO 5	15		6	.020A	.100W	85J	1.500B	5UA	6V	30	
2N111+	-	P	RAY	10	TO 10A	30		15	2.00A	.150W	85J	3.000B	5UA	1.7V	26	
2N111A	-	P	GEC	210	TO 5	30		15	2.00A	.150W	85J	3.000B	5UA	1.7V	30	
2N111B	-	P	GEC	210	TO 5	5		10.0	.005A	.030W	85J	20.000B	10UA	12V	44	
2N117	-	P	GEC	210	TO 5	15		6	.020A	.100W	85J	3.000B	5UA	6V	30	
2N112+	-	P	RAY	10	TO 10A	30		15	2.00A	.150W	85J	5.000B	5UA	1.2V	30	
2N112A	-	P	GEC	210	TO 5	30		15	2.00A	.150W	85J	3.000B	5UA	1.2V	30	
2N113	-	P	GEC	210	TO 5	15		6	.020A	.100W	85J	10.000B	5UA	6V	50	
2N113+	-	P	RAY	210	TO 10A	15		6	.020A	.100W	85J	10.000B	5UA	6V	50	
2N114	-	P	GEC	210	TO 5	15		6	.020A	.100W	85J	20.000B	5UA	6V	70	
2N114+	-	P	RAY	10	TO 10A	30		10	2.00A	.150W	85J	20.000B	5UA	1.2V	74	
2N117	-	N	S	210	TO 5	30		1.0	.025A	.150W	175J	1.000B	10UA	30V	14	
2N117+	-	N	TI, TEC, HUG	210	TO 12C	30		1.0	.025A	.150W	175J	4.000B	2UA	30V	15	
2N118	-	N	S	210	TO 5	30		1.0	.025A	.150W	175J	2.000B	10UA	30V	15	
2N118+	-	N	TI, TEC, HUG	210	TO 12C	45		1.0	.025A	.150W	175J	5.000B	2UA	30V	30	
2N118A	-	N	S	210	TO 5	30		1.0	.025A	.150W	175J	8.000B	10UA	30V	42	
2N118A+	-	N	TI, TEC, HUG	210	TO 12C	45		1.0	.025A	.150W	175J	8.000B	2UA	30V	56	
2N119	-	N	S	2												

Transistor Type No.	N P	G S	Manufacturer	Lead Ident	Out- line	Maximum (V)			Maximum		Max. T.(°C)	Frequency Resp.(MHz)	Leakage		Gain	
						V _{CE}	V _{ES}	V _{BE}	I _C	Power			I _{CE0}	V _{CE0}		I _{CE}
2N126	N	G	ETC	210	To 5	10	10	5.0	.025A	.050W	175J	5.000B	10UA	40V	73	.005A
2N126+	N	G	TI	116	To 10B	10	10	5.0	.008A	.050W	75J	5.000B	2UA	5V	70	
2N128	P	G	SPR,HUG	116	To 24	10	4	10.0	.005A	.025W	85J	28.000G	15UA	10V	40	
2N129	P	G	PHL	105	To 24	10	4	10.0	.005A	.030W	85J	30.000F	3UA	5V	14	
2N130	P	G	ETC	210	To 5	25	22	12.0	.010A	.085W	85J	7.00B	6UA	15V	24	
2N130+	P	G	RAY	210	To 5A	44			.010A	.084W	85J	6.00B	6UA	6V	22	
2N130A	P	G	ETC	210	To 5	25	22	12.0	.100A	.100W	85J	7.00B	15UA	20V	30	
2N131	P	G	ETC	210	To 5	25	12	12.0	.010A	.085W	85J	8.00B	12UA	15V	50	
2N131+	P	G	RAY	210	To 5A	30			.010A	.084W	85J	8.00B	15UA	20V	50	
2N131A	P	G	ETC	210	To 5	25	15	12.0	.100A	.100W	85J	8.00B	15UA	20V	50	
2N132	P	G	ETC	210	To 5	25	12	12.0	.010A	.085W	85J	1.000B	12UA	15V	90	
2N132+	P	G	RAY	210	To 5A	24			.010A	.084W	85J	1.200B	6UA	6V	90	
2N132A	P	G	ETC	210	To 5	25	12	12.0	.100A	.100W	85J	1.000B	15UA	20V	90	
2N133	P	G	ETC	210	To 5	25	15	12.0	.010A	.085W	85J	8.00B	12UA	15V	50	
2N133+	P	G	RAY	210	To 5	25	15	12.0	.010A	.084W	85J	8.00B	12UA	2V	24	
2N133A	P	G	ETC	210	To 5	25	15	12.0	.100A	.100W	85J	8.00B	15UA	20V	50	
2N135	P	G	ETC	210	To 5	20	20R		.050A	.100W	85J	3.000B	5UA	6V	20	
2N135+	P	G	SEC	57	57B	20	12		.050A	.100W	85J	3.000B	5UA	6V	20	
2N136	P	G	ETC	210	To 5	20	20R		.050A	.100W	85J	5.000B	5UA	6V	40	
2N136+	P	G	SEC	57	57B	20	12		.050A	.100W	85J	5.000B	5UA	6V	40	
2N137	P	G	ETC	210	To 5	10	10R		.050A	.100W	85J	7.000B	5UA	6V	45	
2N137+	P	G	SEC	57	57B	1C	6		.050A	.100W	85J	7.000B	5UA	6V	40	
2N138	P	G	ETC	210	To 5	24	12	6	.020A	.050W	50J	AUD	16UA	16V	140	
2N138A	P	G	RAY	148	148A	12	6	5.0	.100A	.150W	85J	1.400B	6UA	12V	60	
2N139	P	G	ETC	210	To 5A	16	16	12.0	.015A	.035W	85J	4.500B	6UA	12V	48	
2N139+	P	G	RAY	55	To 40	16	12		.025A	.035W	70A	4.500B	6UA	12V	48	
2N140	P	G	ETC	210	To 5	16	16	5	.015A	.080W	85J	8.000B	6UA	12V	80	
2N140+	P	G	RCA	55	To 40	16	12		.015A	.035W	70A	7.000B	6UA	12V	60	
2N141	N	G	SVL	148	148A	60	30		8.00A	4.000W	75C	10.000B	5MA	30V	30	
2N142	N	G	SVL	148	148A	60	30		8.00A	4.000W	75C	4.00B	5MA	30V	30	
2N143	N	G	SVL	148	148B	60	30		8.00A	4.000W	75C	4.00B	5MA	30V	30	
2N144	N	G	SVL	148	148B	60	30		8.00A	4.000W	75C	4.00B	5MA	30V	30	
2N144/13	N	G	SVL	430	To 13	60	30		8.00A	4.000W	75C	4.00B	5MA	30V	30	
2N145	N	G	ETC	210	To 5	20	15	5	.025A	.050W	75J	8.000B	3UA	9V	40	
2N145+	N	G	TI	110	To 10B	20	15	5	.025A	.065W	75J	AM IF	3UA	9V		
2N146	N	G	ETC	210	To 5	20	15	5	.025A	.065W	75J	12.000B	3UA	9V	140	
2N146+	N	G	TI	110	To 10B	20	15	5	.025A	.065W	75J	AM IF	3UA	9V		
2N147	N	G	ETC	210	To 5	20	15	5	.025A	.065W	75J	15.000B	3UA	9V	200	
2N147+	N	G	TI	110	To 10B	20	15	5	.025A	.065W	75J	AM IF	3UA	9V		
2N148	N	G	TI	10	To 10B	16			.005A	.065W	75J	AM IF	3UA	12V		
2N148A	N	G	TI	10	To 10B	32			.005A	.065W	75J	AM IF	3UA	12V		
2N149	N	G	TI	10	To 10B	16			.005A	.065W	75J	AM IF	3UA	12V		
2N149A	N	G	TI	10	To 10B	32			.005A	.065W	75J	AM IF	3UA	12V		
2N150	N	G	TI	10	To 10B	16			.005A	.065W	75J	AM IF	3UA	12V		
2N150A	N	G	TI	10	To 10B	32			.005A	.065W	75J	AM IF	3UA	12V		
2N155	N	G	BEN,HUG	605	To 3	30	30S	15.0	3.000A	50.000W	100J	.006E	10MA	30V	48	.500A
2N156	P	G	HUG	426	To 13	30	30	15.0	3.000A	20.000W	85J	.200G	10MA	30V	50	
2N157	P	G	CBS	605	To 3	60	30	30.0	3.000A	20.000W	85J	1.00B	1MA	60V	20	
2N157A	P	G	HUG	426	To 13	60	30	30.0	3.00A	20.000W	85J	1.00B	1MA	90V	20	
2N158	P	G	HUG	426	To 13	60	30	30.0	3.000A	20.000W	85J	.004E	10MA	60V	40	
2N158A	P	G	HUG	426	To 13	80	60	30.0	3.000A	20.000W	85J	.004E	10MA	80V	40	
2N160	N	S	ETC	10	To 22	40	1.0		.025A	.150W	175J	4.000B	10UA	40V	14	.001A
2N160A	N	S	ETC	10	To 22	40	1.0		.025A	.150W	175J	4.000B	10UA	40V	28	.001A
2N161	N	S	ETC	10	To 22	40	1.0		.025A	.150W	175J	5.000B	10UA	40V	14	.001A
2N161A	N	S	ETC	10	To 22	40	5.0		.025A	.150W	175J	5.000B	10UA	40V	28	.001A
2N162	N	S	ETC	10	To 22	40	1.0		.025A	.150W	175J	8.000B	10UA	40V	50	.001A
2N162A	N	S	ETC	10	To 22	40	5.0		.025A	.150W	175J	8.000B	10UA	40V	50	.001A
2N163	N	S	ETC	10	To 22	40	1.0		.025A	.150W	175J	6.000B	10UA	40V	60	.001A
2N163A	N	S	ETC	10	To 22	40	5.0		.025A	.150W	175J	3.000B	10UA	40V	50	.001A
2N164	N	G	ETC	210	To 5	15	15	1.0	.030A	.065W	85J	4.000B	5UA	15V	45	
2N164A	N	G	ETC	210	To 5	15	15	1.0	.030A	.100W	85J	4.000G	5UA	15V	45	
2N165	N	G	ETC	210	To 5	15	15	1.0	.020A	.065W	85C	5.000B	5UA	15V	70	
2N166	N	G	ETC	210	To 5	10	6		.030A	.075W	85A	2.000B	2UA	5V	52	
2N167	N	G	SEC	12	To 12A	30	5.0		.075A	.075W	85A	5.000B	2UA	15V	50	
2N167A	N	G	ETC	12	To 12A	30	5.0		.075A	.075W	85A	5.000B	2UA	15V	50	
2N168	N	G	ETC	210	To 5	15	15R		.020A	.065W	85J	5.000B	5UA	15V	90	.001A
2N168+	N	G	SEC	25	35D	30	30		.020A	.055W	75A	12.000B	5UA	15V	84	
2N168A	N	G	ETC	210	To 5	15	15R		.020A	.065W	85J	5.000B	5UA	15V	90	.001A
2N168A+	N	G	SEC	12	To 12B	15	15		.020A	.065W	85A	5.000B	5UA	15V	40	.001A
2N169	N	G	ETC	210	To 5	15	15R	5.0	.020A	.065W	85J	8.000B	5UA	15V	48	.001A
2N169+	N	G	SEC	12	To 12B	15	15		.020A	.065W	75A	4.000B	5UA	15V	40	.001A
2N169A	N	G	ETC	210	To 5	25	25R	5.0	.020A	.065W	85J	9.000B	5UA	15V	84	
2N169A+	N	G	SEC	12	To 12A	25	25	5.0	.025A	.075W	85A	9.000B	5UA	15V	50	.001A
2N170	N	G	ETC	210	To 5	10	9R		.020A	.025W	85J	4.000B	3UA	5V	30	
2N172	N	G	ETC	210	To 5	16	15R	1.0	.025A	.075W	75J	3.000B	3UA	9V	40	
2N172+	N	G	TI	110	To 10B	16			.005A	.065W	75J	AM CON	3UA	9V		
2N173	P	G	RCA,DEL.MOT.ETC.SOL,HUG	405	To 36	60	50	40.0	15.000A	150.000W	100C	1.01E	100UA	2V	36	
2N174	P	G	DEL.MOT.ETC.SOL,HUG	405	To 36	80	55	60.0	15.000A	150.000W	100C	0.01E	100UA	2V	36	
2N174A	P	G	ETC,DEL.MOT	405	To 36	80	70S	60.0	15.000A	170.000W	100J	1.00B	4MA	80V	60	1.200A
2N175	P	G	ETC	55	To 5	25	12.0		.002A	.050W	85J	8.00B	12UA	25V	65	
2N175+	P	G	RCA	55	To 40	10	10		.002A	.020W	50A	850B	12UA	25V	64	
2N175A	P	G	ETC,RCA,BEN,ETC,HUG	605	To 3	40	30S	15.0	3.000A	10.000W	90J	.005E	3MA	30V	54	
2N178	P	G	MOT,ETC	605	To 3	40	30S	15.0	3.000A	10.000W	90J	.005E	3MA	30V	30	
2N180	P	G	ETC	210	To 5	30	30		.025A	.150W	75J	7.00B	10UA	30V	60	
2N180+	P	G	CBS	35	To 35C	30	30.0		.150W	.75J	7.00B	10UA	30V	60		
2N181	P	G	ETC	210	To 5	30	30		.038A	.250W	75J	7.00B	16UA	25V	60	
2N181+	P	G	CBS	35	To 35D	30	30.0		.250W	.75J	7.00B	10UA	30V	60		
2N182	N	G	ETC	210	To 5	25	15.0		.010A	.100W	85J	10.000B	3UA	10V	30	
2N182+	N	G	CBS	35	To 35C	25	20.0		.100W	.75J	10.000B	3UA	10V	25		
2N183	N	G	ETC	210	To 5	25	15.0		.010A	.100W	85J	10.000B	3UA	10V	45	
2N183+	N	G	CBS	35	To 35C	25	20.0		.100W	.75J	5.000B	3UA	10V	50		
2N184	N	G	ETC	210	To 5	25	15.0		.010A	.100W	85J	10.000B	3UA</			

Transistor Type No.	M P	G S	Manufacturer	Lead Ident	Out- line	Maximum (V)			Maximum		Max. T.(°C)	Frequency Resp.(MHz)	Leakage I _{ce} @ V _{ce}	Gain h _{FE} @ I _c	
						V _{CE}	V _{ES}	V _{ES}	I _c	Power					
2N190	P	G	ETC	210	TO 5	25	25R	.050A	.075W	60J	1.000B	16UA	25V	50 .020A	
2N190+	P	G	GEC	57	57B	5	25R	.050A	.175W	60A	1.000B	16UA	25V	36	
2N191	P	P	G	210	TO 5	25	25R	.050A	.075W	60J	1.200B	16UA	25V	60 .020A	
2N191+	P	P	G	210	TO 5	25	25R	.050A	.175W	60A	1.200B	16UA	25V	54	
2N192	P	P	G	210	TO 5	25	25R	.050A	.075W	60J	1.500B	16UA	25V	114 .020A	
2N192+	P	P	G	57	57B	25	25R	.050A	.175W	60A	1.500B	16UA	25V	74	
2N193	P	N	G	210	TO 5	18	18R	5.0	.100A	.150W	85J	2.000B	30UA	18V	8
2N193+	P	N	G	210	TO 22	18	18	5.0	.100A	.150W	85J	2.000B	30UA	18V	10
2N194	P	N	G	210	TO 5	25	25R	.100A	.050W	75J	2.000B	40UA	15V	10	
2N194+	P	N	G	210	TO 22	18	18R	5.0	.100A	.150W	85J	2.000B	30UA	18V	10
2N195	P	P	G	172	172D	15	12	6.0	.030A	.100W	85J	800B	101A	12V	50
2N196	P	P	G	172	172D	30	25	6.0	.030A	.100W	85J	700B	101A	12V	40
2N197	P	P	G	172	172D	30	25	6.0	.030A	.100W	85J	500B	10UA	12V	15
2N198	P	P	G	172	172D	36	30	12.0	.100A	.100W	85J	400B	4UA	12V	30
2N199	P	P	G	172	172D	36	30	12.0	.100A	.100W	85J	400B	4UA	12V	15
2N200	P	P	G	172	172D	36	30	12.0	.100A	.100W	85J	400B	4UA	12V	15
2N204	P	P	G	210	TO 5	12	12	0.0	.050A	.075W	85J	800B	10UA	20V	50
2N205	P	P	G	210	TO 5	12	12	0.0	.020A	.050W	65J	2.000B	15UA	12V	50
2N206	P	P	G	210	TO 5	12	12	0.0	.020A	.050W	65J	2.000B	10UA	12V	50
2N207	P	P	G	210	TO 5	12	12	0.0	.020A	.050W	65J	2.000B	10UA	12V	50
2N207A	P	P	G	116	23	12	12.0	.020A	.050W	65J	2.000B	10UA	12V	35	
2N207B	P	P	G	210	TO 23	12	12.0	.020A	.050W	65J	2.000B	20UA	10V	10	
2N207B+	P	P	G	210	TO 22	10	10	5.0	.100A	.050W	75J	2.000B	30UA	10V	10
2N211	P	N	G	210	TO 5	18	18R	5.0	.100A	.150W	85J	4.000B	30UA	18V	18
2N211+	P	N	G	210	TO 22	18	18	5.0	.100A	.150W	85J	4.000B	30UA	18V	10
2N212	P	N	G	210	TO 5	40	25R	10.0	.180W	85J	0.01E	100UA	25V	40	
2N212+	P	N	G	210	TO 22	40	25R	10.0	.180W	85J	0.01E	100UA	25V	40	
2N213	P	N	G	210	TO 5	40	25R	10.0	.180W	85J	7.00G	50UA	18V	150	
2N213+	P	N	G	210	TO 22	40	25R	10.0	.180W	85J	0.01E	100UA	25V	160	
2N213A	P	N	G	210	TO 22	40	25R	10.0	.180W	85J	1.000G	50UA	40V	170	
2N214	P	N	G	210	TO 5	40	25R	10.0	.180W	85J	0.01E	50UA	40V	44	
2N214+	P	N	G	210	TO 22	40	25R	10.0	.180W	85J	7.00B	10UA	12V	44	
2N215	P	P	G	120	TO 1	30	12.0	.050A	.150W	70A	7.00B	10UA	12V	44	
2N215+	P	P	G	210	TO 5	18	18R	1.0	.050A	.050W	75J	2.000B	50UA	18V	40
2N216	P	N	G	210	TO 5	18	18R	1.0	.050A	.050W	75J	2.000B	40UA	18V	40
2N216+	P	N	G	210	TO 22	15	25	12.0	.070A	.150W	85J	AUD	14UA	25V	75 .050A
2N217	P	P	G	120	TO 1	25	25	12.0	.070A	.150W	71A	AUD	14UA	25V	76
2N217+	P	P	G	210	TO 5	16	16	12.0	.015A	.035W	85J	4.500B	6UA	12V	48
2N218	P	P	G	120	TO 1	16	16	12.0	.015A	.035W	70A	7.000B	6UA	12V	48
2N219	P	P	G	210	TO 5	16	16	12.0	.015A	.080W	85J	9.000B	6UA	12V	75
2N219+	P	P	G	210	TO 5	25	25	12.0	.022A	.050W	85J	8.50B	12UA	25V	65
2N220	P	P	G	120	TO 1	10	10	18	.002A	.020W	50A	8.50B	12UA	25V	64
2N223	P	P	G	210	TO 5	18	18	1.0	.150A	250W	75J	6.00B	20UA	9V	80
2N223+	P	P	G	116	TO 25	18	18	1.0	.150A	250W	75J	5.10B	25UA	12V	90
2N224	P	P	G	106	TO 25	25	25	1.0	.150A	120W	65A	5.10B	25UA	12V	70
2N224+	P	P	G	106	TO 25	25	25	1.0	.150A	120W	65A	4.00B	25UA	30V	60 .100A
2N225	P	G	M.P.2N224	210	TO 5	30	25	1.0	.150A	250W	75J	4.00B	25UA	30V	60
2N226	P	G	ETC	106	TO 25	25	25	1.0	.150A	120W	65A	4.00B	25UA	12V	60
2N226+	P	G	PHL	106	TO 25	25	25	1.0	.150A	120W	65A	4.00B	25UA	12V	60
2N227	P	G	ETC	210	TO 5	40	15R	10.0	.100A	.150W	85J	.010E	4A	40V	80
2N228	P	N	G	210	TO 22	40	15R	10.0	.100A	.180W	85J	.600G	100UA	40V	70
2N228+	P	N	G	210	TO 5	10	10R	10.0	.100A	.180W	85J	.600G	100UA	10V	50
2N229	P	N	G	210	TO 22	10	10R	20.0	.100A	.180W	85J	.600B	100UA	10V	60
2N229+	P	N	G	116	TO 24	5	5S	5.0	.003A	.009W	85J	LS SW	3UA	3V	36
2N231	P	N	G	210	TO 5	10	10R	5.0	.100A	.150W	85J	2.000B	10UA	10V	10
2N233	P	N	G	210	TO 22	10	10R	5.0	.100A	.150W	85J	2.000B	10UA	18V	10
2N233+	P	N	G	210	TO 22	18	18R	5.0	.100A	.150W	85J	2.000B	30UA	18V	24
2N233A	P	N	G	210	TO 22	18	18R	5.0	.100A	.150W	85J	2.000B	30UA	18V	24
2N233A+	P	N	G	605	TO 3	25	25R	15.0	3.000A	25.000W	90J	.008E	5MA	25V	40
2N234A	P	P	G	605	TO 3	35	35	15.0	3.000A	25.000W	90J	.007E	1MA	25V	56
2N235A	P	P	G	605	TO 3	35	35	15.0	3.000A	25.000W	100J	.006E	1MA	25V	55
2N235B	P	P	G	605	TO 3	35	35	15.0	3.000A	25.000W	100J	.006E	1MA	25V	55
2N235B+	P	P	G	210	TO 5	45	15	5.0	.020A	.150W	85J	5.00B	10UA	45V	40
2N237	P	P	G	10	10B	20	20	2.00A	0.050W	60A	AUD	20UA	20V	50	
2N238	P	P	G	116	TO 24	6	6S	5.0	.015A	.030W	85J	25.000G	3UA	5V	30
2N240	P	P	G	116	TO 24	6	6S	5.0	.020A	.100W	60J	1.300B	16UA	25V	80 .020A
2N241	P	P	G	210	TO 5	25	25R	5.0	.200A	.100W	60A	1.300B	16UA	25V	70
2N241+	P	P	G	210	TO 5	25	25R	5.0	.200A	.200W	75J	1.300B	16UA	25V	80 .020A
2N241A	P	P	G	210	TO 5	25	25R	5.0	.200A	.200W	75A	1.300B	16UA	25V	70
2N241A+	P	P	G	57	57B	25	25R	5.0	5.000A	106.000W	110J	.005E	5MA	45V	60 .500A
2N242	P	P	G	10	TO 22	60	60	1.0	.060A	.750W	150J	AUD	1UA	30V	15
2N243	P	N	S	10	TO 22	60	60	1.0	.060A	.750W	150J	AUD	1UA	30V	50
2N244	P	N	S	185	185A	60	60	1.0	.060A	1.000W	150J	AUD	1UA	30V	50
2N245	P	N	S	185	185A	60	60	1.0	.060A	1.000W	150J	AUD	1UA	30V	50
2N246	P	N	S	75	TO 7	35	35	1.0	.010A	.035W	71A	130.000G	16UA	30V	65
2N247	P	P	G	217	TO 33	40	40	5.0	.010A	.120W	100J	20.000G	50UA	40V	80
2N247/33	P	P	G	217	TO 33	40	40	5.0	.005A	.030W	75A	50.000B	10UA	25V	20
2N248	P	P	G	110	TO 5	25	25	2.00A	.250W	85J	AUD	25UA	25V	10	
2N249	P	P	G	110	TO 5	25	25	2.00A	.350W	60A	AUD	25UA	25V	50	
2N249+	P	P	G	605	TO 3	30	30	15.0	2.000A	12.000W	85J	.008E	1UA	30V	90
2N250	P	P	G	605	TO 3	40	25	20.0	7.000A	90.000W	100J	.160G	1MA	30V	60
2N250A	P	P	G	605	TO 3	60	15.0	15.0	2.000A	12.000W	85A	.008E	2MA	30V	60
2N251	P	P	G	605	TO 3	60	15.0	15.0	7.000A	90.000W	100J	.160G	2MA	30V	60
2N251A	P	P	G	605	TO 3	60	35	20.0	.005A	.030W	55J	AM RF	10UA	12V	30
2N252	P	P	G	210	TO 5	10	10B	16	.005A	.030W	75J	5.000G	10UA	12V	30
2N252+	P	P	G	210	TO 5	12	12	12	.050A	.100W	75J	2.500B	3UA	9V	40
2N253	P	N	G	210	TO 10	10B	12	12	.005A	.065W	75J	5.000G	13UA	20V	20
2N253+	P	N	G	210	TO 10	10B	20	20	.005A	.050W	75J	3.000B	10UA	12V	40
2N254	P	N	G	10	TO 10	10B	20	20	.005A	.065W	75J	5.000G	3UA	9V	40
2N254+	P	N	G	605	TO 3	15	15	15.0	3.000A	25.000W	85J	.200B	3MA	14V	40 .500A
2N255	P	P	G	605	TO 3	15	15R	15.0	5.000A	20.000W	100J	.005E	5MA	30V	40
2N255A	P	P	G	605	TO 3	30	30R	30.0	3.000A	25.000W	100J	.005E	3MA	30V	50
2N256	P	P	G	605	TO 3	40	35S	6.0	3.000A	45.000W	95J	.005E	5MA	25V	36
2N256A	P	P	G	605	TO 3	40	35S	6.0	3.000A	25.000W	100J	.005E	2MA	20V	20
2N257	P	P	G	605	TO 3	40	35S	6.0	3.000A	4					

Transistor Type No.	N P S	G L S	Manufacturer	Lead Ident	Out- line	Maximum (V)			Maximum I _b	Maximum Power	Max. T. _j (°C)	Frequency Resp.(MHz)	Leakage		Gain K _β @ I _c	
						V _{CE}	V _{BE}	V _{ES}					I _{CEO} @ V _{CE}	I _{ES} @ V _{BE}		
2N269	P	G	ETC	120	TO 5	25	24	12.0	.100A	.120W	85J	4.000B	5UA	12V	45	.012A
2N269+	-P	G	RCA	210	TO 1	25	24	12.0	.100A	.120W	85J	13.000B	5UA	12V	45	
2N270	P	G	ETC	120	TO 5	25	12	12.0	.150A	.250W	85J	AUD	16UA	25V	70	.150A
2N270+	-P	G	RCA	155	55B	25	12	12.0	.075A	.250W	71A	AUD	16UA	25V	70	
2N271	P	G	ETC	210	TO 5	30	10	20.0	.200A	.150W	85J	5.000B	5UA	12V	50	
2N271+	-P	G	RAY	10	TO 10A	30	10	20.0	.200A	.150W	85J	1.000B	5UA	12V	44	
2N271A	P	G	ETC	210	TO 5	30	10	20.0	.200A	.150W	85J	5.000B	5UA	12V	50	
2N272	P	G	ETC	210	TO 5	24	24	24	.100A	.150W	85J	5.00B	10UA	20V	120	
2N272+	-P	G	RAY	10	TO 10A	24	24	24	.100A	.150W	85J	1.000B	6UA	20V	80	
2N273	P	G	ETC	210	TO 5	20	30	9	.100A	.150W	85J	AUD	10UA	20V	20	
2N273+	-P	G	RAY	10	TO 10A	20	30	9	.100A	.150W	85J	AUD	10UA	20V	20	
2N274	P	G	RCA	128	TO 44	35		.5	.010A	.120W	100A	30.000B	12UA	12V	80	
2N277	P	G	DEL, MOT, RCA, ETC, SOL, HUG	405	TO 36	40	25	20.0	15.000A	150.000W	100C	.010E	100UA	2V	50	
2N278	P	G	DEL, MOT, RCA, ETC, SOL, HUG	405	TO 36	50	30	30.0	15.000A	150.000W	100C	.010E	100UA	2V	50	
2N279	P	G	ETC	210	TO 5	20	20R	5	.075A	.125W	75J	.300B	10UA	4V	30	
2N280	P	G	ETC	210	TO 5	20	20R	5	.075A	.125W	75J	.300B	10UA	4V	30	
2N281	P	G	ETC	210	TO 5	16	16R	10.0	.075A	.125W	75J	.300B	10UA	4V	50	
2N282	P	G	ETC	210	TO 5	16	16R	10.0	.075A	.125W	75J	.300B	10UA	4V	50	
2N283	P	G	ETC	210	TO 5	30	20	10.0	.050A	.125W	75J	.500B	9UA	30V	44	.080A
2N284	P	G	ETC	210	TO 5	32	32R	10.0	.125A	.125W	75J	.350B	10UA	10V	45	.080A
2N284A	P	G	ETC	210	TO 5	60	55R	10.0	1.25A	.125W	75J	.350B	10UA	10V	45	.080A
2N285A	P	G	BEN, ETC, HUG	605	TO 3	35	15.0		3.000A	25.000W	100I	.006E	1MA	25V	1.000A	
2N285B	P	G	BEN, ETC, HUG	1605	TO 3	35	15.0		3.000A	25.000W	100I	.006E	80UA	15V	80	.420A
2N291	P	G	ETC	210	TO 5	25	12	15.0	.200A	.180W	50J	AUD	25UA	25V	60	
2N291+	-P	G	GEN	110	TO 100	25	12	15.0	.200A	.300W	85J	AUD	25UA	25V	44	.001A
2N292	P	G	ETC	210	TO 5	15	15R	.5	.020A	.065W	85J	5.000B	5UA	15V	25	
2N292+	-P	G	ETC	12	TO 12A	15	15	.5	.020A	.065W	85A	5.000B	5UA	15V	44	
2N292A	P	G	ETC	210	TO 5	15	15R	.5	.020A	.100W	85J	5.000B	5UA	15V	21	.001A
2N293	P	G	ETC	210	TO 5	15	15R	.5	.020A	.065W	85J	5.000B	5UA	15V	38	
2N293+	-P	G	ETC	12	TO 12A	15	15	.5	.020A	.065W	85A	5.000B	5UA	15V	25	
2N296	P	N	S BEN, HUG	605	TO 3	60	15.0		2.000A	20.000W	100I	.005E	2MA	60V	1.000A	
2N297	P	G	ETC, HUG	605	TO 3	60	50S	9.0	5.000A	45.000W	95J	.005E	5MA	60V	2.000A	
2N297A	P	G	BEN, MOT, ETC, HUG	605	TO 3	60	40	40.0	4.000A	35.000W	100J	.005E	200UA	2V	70	.500A
2N299	P	G	PHL	124	TO 30	5			.005A	.020W	85J	90.000F	3UA	5V	10	
2N300	P	G	PHL	124	TO 30	5			.005A	.020W	85J	85.000F	3UA	5V	10	
2N301	P	G	BEN, DEL, MOT, ETC, SOL, HUG	605	TO 3	40	32	10.0	3.000A	45.000W	95J	.006E	3MA	30V	60	.700A
2N301A	P	G	BEN, DEL, MOT, ETC, SOL, HUG	605	TO 3	60	32	10.0	3.000A	45.000W	95J	.006E	3MA	30V	60	.700A
2N302	P	G	ETC	210	TO 5	15	10	2.0	.200A	.150W	85J	7.000B	6UA	10V	50	.001A
2N303	P	G	ETC	210	TO 5	15	10	2.0	.200A	.150W	85J	14.000B	6UA	10V	80	.001A
2N306	P	G	ETC	210	TO 5	20	15R	10.0	.100A	.180W	85J	6.00B	20UA	20V	74	
2N306+	-P	G	SYL	110	TO 22	20	15R	10.0	.180W	.180W	85J	6.00B	20UA	20V	74	
2N307	P	G	MOT, BEN, ETC, HUG	605	TO 3	35	35	10.0	5.000A	106.000W	110J	.005E	15MA	35V	40	.200A
2N307A	P	G	MOT, BEN, ETC, HUG	605	TO 3	35	35	10.0	5.000A	106.000W	110J	.005E	7MA	35V	60	.200A
2N307B	P	G	ETC	605	TO 3	35	35	10.0	2.000A	16.000W	95J	.005E	5MA	35V	60	
2N308	P	G	SYL	210	TO 5	20	20	20	.005A	.030W	55J	AM IF	10UA	9V	30	
2N308+	-P	G	ETC	10	TO 10B	20	20	20	.005A	.030W	55A	AM IF	10UA	9V	30	
2N309	P	G	ETC	210	TO 5	20	20	20	.005A	.030W	10J	AM IF	9UA			
2N309+	-P	G	ETC	10	TO 10B	20	20	20	.005A	.030W	55A	AM IF	9UA			
2N310	P	G	ETC	210	TO 5	20	30	30	.005A	.030W	10J	AM IF	9UA			
2N310+	-P	G	ETC	10	TO 10B	20	30	30	.005A	.030W	55A	AM IF	10UA	9V	50	
2N311	P	G	ETC	210	TO 5	15	15	15.0	.005A	.150W	85J	AUD	15UA	15V	50	
2N312	P	G	ETC	210	TO 5	15	15	15.0	.005A	.100W	85J	LS SW	15UA	15V	50	
2N312+	-P	G	ETC	210	TO 5	15	15	15.0	.500A	.100W	85J	5.000B	2UA	5V	22	.100A
2N315	P	G	ETC, TII	210	TO 5	30	20	20.0	.500A	.100W	85J	5.000B	2UA	5V	34	.100A
2N315A	P	G	ETC, TII	210	TO 5	30	20	20.0	.500A	.100W	85J	12.000B	2UA	5V	34	.200A
2N316	P	G	ETC	210	TO 5	30	15	20.0	.500A	.100W	85J	12.000B	2UA	5V	35	.400A
2N316A	P	G	ETC	210	TO 5	30	15	20.0	.500A	.100W	85J	20.000B	2UA	5V	35	.400A
2N317	P	G	ETC, TII	210	TO 5	25	10	20.0	.500A	.150W	85J	20.000B	2UA	5V	35	.400A
2N317A	P	G	ETC, TII	210	TO 5	25	20R	5.0	.200A	.225W	85J	2.000B	16UA	25V	34	
2N320	P	G	ETC, GEC, MOT	212	TO 5	25	20	5.0	.200A	.225W	85J	2.500B	16UA	25V	50	
2N321	P	G	ETC, GEC, MOT, SES	212	TO 5	25	20R	5.0	.200A	.225W	85J	2.500B	16UA	25V	50	
2N322	P	G	ETC, GEC, MOT, SES	212	TO 5	18	18R	5.0	.200A	.200W	60J	1.000B	16UA	16V	50	
2N323	P	G	ETC, GEC, MOT, SES	212	TO 5	18	18R	5.0	.200A	.200W	60J	1.500B	16UA	16V	80	
2N324	P	G	ETC, GEC, MOT, SES	212	TO 5	18	18R	5.0	.200A	.140W	60J	1.500B	16UA	16V	130	
2N325	P	G	ETC, GEC, MOT, SES	605	TO 3	35	35	10.0	2.000A	12.000W	85J	500.00F	500UA	30V	40	
2N326	P	G	ETC, GEC, MOT, SES	605	TO 3	35	35	10.0	2.000A	7.000W	85J	.005E	500UA	30V	44	
2N327	P	G	ETC, GEC, MOT, SES	170	TO 9	40	35	20.0	.050A	.330W	160A	3.00B	5NA	20V	24	
2N327A	P	G	HUG, RAY, SSO, TII, ETC, NSC	210	TO 5	50	40	20.0	.050A	.330W	160J	5.000G	100NA	30V	14	.003A
2N327B	P	S	RAY, SOL, HUG	210	TO 5	50	40	20.0	.050A	.400W	200J	2.000G	1NA	30V	15	.003A
2N328	P	S	RAY	170	TO 9	30	35	20.0	.050A	.330W	160A	3.00B	5NA	20V	24	
2N328A	P	S	HUG, RAY, SSO, TII, ETC, NSC	210	TO 5	50	35	20.0	.050A	.330W	160J	5.000G	100NA	30V	26	.003A
2N328B	P	S	RAY, SOL, HUG	210	TO 5	50	35	20.0	.050A	.400W	200J	2.000G	1NA	30V	26	.003A
2N329	P	S	RAY	170	TO 9	20	35	20.0	.050A	.330W	160A	3.00B	5NA	20V	24	
2N329A	P	S	HUG, RAY, SSO, TII, ETC, NSC	210	TO 5	50	30	20.0	.050A	.330W	160A	6.00B	5NA	20V	50	
2N329B	P	S	RAY, SOL, HUG	210	TO 5	50	30	20.0	.050A	.400W	200J	15.000G	100NA	30V	60	.003A
2N330	P	S	SSO, SOL, HUG	170	TO 9	20	35	20.0	.050A	.330W	160A	3.00B	5NA	20V	30	
2N330A	P	G	ETC, MOT, GIC	210	TO 5	30	12.0		.200A	.200W	175J	1.000B	2UA	30V	14	
2N332	N	S	GEC, TEC, TII, ETC, HUG	210	TO 5	45	1.0		.025A	.500W	175J	2.000B	2UA	30V	31	
2N332A	N	S	GEC, TEC, TII, ETC, HUG	210	TO 5	45	45	4.0	.025A	.500W	175J	2.500B	500NA	30V	16	
2N333	N	S	GEC, TEC, TII, ETC, HUG	210	TO 5	45	1.0		.025A	.150W	175J	2.000B	2UA	30V	31	
2N333A	N	S	GEC, TEC, TII, ETC, HUG	210	TO 5	45	45	4.0	.025A	.150W	175J	2.500B	500NA	30V	30	
2N334	N	S	GEC, TEC, TII, ETC, HUG	210	TO 5	45	45	4.0	.025A	.150W	175J	8.000B	2UA	30V	38	
2N334A	N	S	GEC, TEC, TII, ETC, HUG	210	TO 5	45	45	4.0	.025A	.500W	175J	8.000B	500NA	30V	56	
2N335	N	S	GEC, TEC, TII, ETC, HUG	210	TO 5	45	45	4.0	.025A	.150W	175J	2.000B	2UA	30V	60	
2N335A	N	S	GEC, TEC, TII, ETC, HUG	210	TO 5	45	60	4.0	.025A	.500W	175J	2.500B	500NA	30V	60	
2N335B	N	S	GEC, TEC, TII, ETC, HUG	210	TO 5	45	45	4.0	.025A	.500W	175J	2.500B	500NA	30V	60	
2N336	N	S	GEC, TEC, TII, ETC, HUG	210	TO 5	45	45	4.0	.025A	.500W						

Transistor Type No.	M P	G S	Manufacturer	Lead Count	Out- line	Maximum (V)			Maximum		Max. T.C.	Frequency Resp.(MHz)	Leakage		Gain h _{FE} @ I _C
						V _{CE}	V _{BE}	V _{ES}	I _C	Power			I _{ES} @ V _{CE}	I _{CS} @ I _C	
2N350	P	G	BEN,ETC,HUG	605	To 3	40	30	10.0	3.000A	25.000W	100J	.005E	3MA	30V	40
2N350A	P	G	MOT,BEN,ETC,HUG	605	To 3	50	40	10.0	6.000A	40.000W	100J	.005E	3MA	30V	50
2N351	P	G	RCA,BEN,ETC,HUG	605	To 3	40	30S	10.0	3.000A	10.000W	50J	AUD	3MA	30V	60
2N351A	P	G	MOT,BEN,HUG	605	To 3	50	40	10.0	6.000A	40.000W	100J	.005E	3MA	30V	60
2N356	N	G	BEN,ETC	210	To 5	20	12	20.0	.500A	.100W	100J	3.000B	5UA	5V	34
2N356A	N	G	ETC	210	To 5	30	20	20.0	.500A	.150W	85J	3.000B	5UA	5V	34
2N357	N	G	ETC	210	To 5	20	15	20.0	.500A	.100W	100J	6.000B	5UA	5V	40
2N357+	N	G	TAD	170	To 9	20	15	20.0	.500A	.100W	75A	6.000B	5UA	5V	40
2N357A	N	G	ETC	210	To 5	20	12	20.0	.500A	.100W	100J	6.000B	5UA	5V	30
2N358	N	G	ETC	210	To 5	20	12	20.0	.500A	.100W	75A	9.000B	5UA	5V	50
2N358+	N	G	TAD,SVL	170	To 9	20	12	20.0	.500A	.100W	75A	9.000B	5UA	5V	50
2N358A	N	G	ETC	210	To 5	30	15	20.0	.500A	.150W	100J	9.000B	5UA	5V	50
2N359	P	G	ETC	210	To 5	32	30R	6.0	.200A	.175W	95J	2.500B	10UA	12V	44
2N360	P	G	ETC	210	To 5	32	30R	6.0	.200A	.175W	95J	2.500B	10UA	12V	44
2N361	P	G	ETC	210	To 5	25	18	6.0	.100A	.175W	75J	2.000B	10UA	12V	50
2N362	P	G	ETC	210	To 5	40	30	6.0	.100A	.175W	75J	2.000B	10UA	12V	50
2N363	P	G	ETC	210	To 5	30	25R	0.0	.075A	.150W	85J	1.000B	10UA	30V	14
2N364	N	G	ETC	10	10B	30	2.0	.050A	.150W	75J	1.000B	10UA	30V	14	
2N364+	N	G	ETC	210	To 5	30	25R	2.0	.075A	.150W	85J	1.000B	10UA	30V	38
2N365	N	G	ETC	10	10B	30	2.0	.050A	.150W	75J	1.000B	10UA	30V	38	
2N365+	N	G	ETC	210	To 5	30	25R	2.0	.075A	.150W	85J	1.000B	10UA	30V	38
2N366	N	G	ETC	10	10B	30	2.0	.050A	.150W	75J	1.000B	10UA	30V	38	
2N366+	N	G	ETC	210	To 5	30	25R	2.0	.075A	.150W	85J	1.000B	10UA	30V	38
2N367	P	G	ETC	210	To 5	30	25R	10.0	.075A	.150W	85J	4.00B	20UA	30V	34
2N368	P	G	ETC	210	To 5	30	25R	10.0	.075A	.150W	85J	4.00B	20UA	30V	34
2N368+	P	G	ETC	210	To 5	30	25R	10.0	.075A	.150W	85J	4.00B	20UA	30V	34
2N369	P	G	ETC	210	To 5	30	25R	10.0	.075A	.150W	85J	4.00B	20UA	30V	34
2N369+	P	G	ETC	210	To 5	30	25R	10.0	.075A	.150W	85J	4.00B	20UA	30V	34
2N370	P	G	ETC	210	To 5	30	25R	10.0	.075A	.150W	85J	4.00B	20UA	30V	34
2N370+	P	G	ETC	210	To 5	30	25R	10.0	.075A	.150W	85J	4.00B	20UA	30V	34
2N371	P	G	RCA	75	To 7	20	1.5	.010A	.080W	71A	130.000G	20UA	60V	60	
2N372	P	G	RCA	75	To 7	20	1.5	.010A	.080W	71A	130.000G	20UA	12V	60	
2N372+	P	G	RCA	75	To 7	25	1.5	.010A	.080W	71A	130.000G	8UA	12V	60	
2N373	P	G	RCA	75	To 7	25	1.5	.010A	.080W	71A	130.000G	8UA	12V	60	
2N374	P	G	RCA	75	To 7	25	1.5	.010A	.080W	71A	130.000G	8UA	12V	60	
2N375	P	G	BEN,MOT,ETC,HUG	605	To 3	80	60R	20.0	3.000A	90.000W	90J	.007E	3MA	30V	60
2N376	P	G	RCA,MOT,BEN,ETC,HUG	605	To 3	40	30R	10.0	3.000A	65.000W	90J	.007E	3MA	30V	60
2N376A	P	G	MOT,BEN,ETC,HUG	605	To 3	50	40R	10.0	3.000A	60.000W	100J	.005E	3MA	30V	80
2N377	N	G	ETC,TAD,TII	210	To 5	25	20R	15.0	.200A	-.150W	100J	6.000B	20UA	20V	40
2N378	N	G	ETC	210	To 5	40	40X	15.0	.200A	-.150W	100J	6.000B	40UA	40V	35
2N378+	N	G	ETC	210	To 5	40	40X	15.0	.200A	-.150W	100J	6.000B	40UA	40V	35
2N379	P	G	MOT,BEN,ETC,HUG	605	To 3	20	40	20.0	5.000A	106.000W	110J	.003E	500UA	25V	40
2N379+	P	G	DEL,TSE,MOT,BEN,ETC,HUG	605	To 3	80	60	20.0	7.000A	100.000W	110J	.003E	500UA	25V	40
2N380	P	G	ETC	212	To 5	50	25R	20.0	.400A	-.225W	85J	3.000B	15UA	25V	40
2N381	P	G	ETC	212	To 5	50	25R	20.0	.400A	-.225W	85J	4.000B	10UA	25V	100
2N382	P	G	ETC,MOT,TSE	212	To 5	50	25R	20.0	.400A	-.225W	100J	5.000B	10UA	25V	100
2N383	P	G	MOT,TSE,ETC	212	To 5	40	40	5.0	0.100A	-.100W	100A	50.000B	12UA	12V	100
2N384	P	G	CSF,RCA	212	To 5	25	25R	15.0	.200A	-.150W	100J	4.000B	10UA	25V	70
2N385	N	G	TAD,ETC	212	To 5	40	15.0	.200A	-.200W	100J	4.000B	40UA	40V	70	
2N385A	N	G	CSF,RCA,TAD,TII,ETC,ITT	212	To 5	25	20	15.0	.200A	-.150W	100J	4.000B	10UA	25V	120
2N388	N	G	TII,RCA,TAD,ETC	212	To 5	40	15.0	.200A	-.200W	100J	4.000B	10UA	25V	120	
2N388A	N	G	TII,RCA,TAD,ETC	212	To 5	40	15.0	.200A	-.200W	100J	4.000B	10UA	25V	120	
2N389	N	S	AMF,TEC,TII,BEN,HUG	731	To 53	60	60R	10.0	3.000A	85.000W	200J	8.500G	10MA	60V	36
2N389A	N	S	AMF,TEC,TII,BEN,HUG	731	To 53	60	60R	10.0	3.000A	85.000W	200J	2.000B	10MA	60V	36
2N392	P	G	DEL,ETC,HUG	605	To 3	60	45	40.0	5.000A	90.000W	100J	.006E	8MA	60V	110
2N393	P	G	SPR,HUG	116	To 24	6	6	6.0	.050A	-.035W	100J	25.000G	6UA	10V	44
2N394	P	G	ETC,GE	212	To 5	30	20R	15.0	.200A	-.150W	85J	3.000B	6UA	15V	60
2N395	P	G	GE,ETC,TAD,TII	212	To 5	20	20R	10.0	.200A	-.150W	85J	5.000B	6UA	20V	70
2N396	P	G	GE,ETC,ETC,TAD,TII	212	To 5	20	20R	10.0	.200A	-.150W	85J	8.000B	6UA	15V	100
2N396A	P	G	ETC	212	To 5	30	20	20.0	.200A	-.200W	85J	10.000B	6UA	15V	100
2N397	P	G	CSF,GE,TII,TAD	210	To 5	80	15R	20.0	.200A	-.200W	85J	5.000B	50UA	105V	40
2N398	P	G	RCA,MOT,TII	210	To 5	105	105S	50.0	.100A	-.150W	100A	5.000B	50UA	105V	40
2N398A	P	G	RCA,MOT,TII	210	To 5	105	105S	50.0	.100A	-.150W	100A	5.000B	50UA	105V	40
2N398B	P	G	RCA,TII,TAD	210	To 5	105	105S	50.0	.100A	-.150W	100A	1.00B	25UA	105V	60
2N399	P	G	BEN,ETC,HUG	605	To 3	35	15.0	3.000A	25.000W	100J	.006E	2MA	25V	56	
2N400	P	G	BEN,ETC,HUG	605	To 3	35	15.0	3.000A	25.000W	100J	.006E	1MA	25V	50	
2N401	P	G	BEN,ETC,HUG	605	To 3	35	15.0	3.000A	25.000W	100J	.006E	1MA	25V	50	
2N402	P	G	ETC	210	To 5	25	20	10.0	.150A	.180W	85J	3.00B	15UA	20V	30
2N403	P	G	ETC	210	To 5	25	20	10.0	.200A	.180W	85J	4.00B	15UA	20V	30
2N404	P	G	CSF,GE,RCA,AMP,ETC,TAD	210	To 5	25	24	12.0	.200A	.150W	100A	12.000B	5UA	12V	35
2N404A	P	G	CSF,GE,RCA,ETC,TAD,TII,GE	210	To 5	40	35	25.0	.200A	.150W	100J	12.000B	5UA	12V	35
2N405	P	G	ETC	210	To 5	20	18	2.5	.035A	.150W	71A	.650B	14UA	12V	50
2N405+	P	G	RCA	55	To 40	20	18	2.5	.035A	.150W	71A	.650B	14UA	6V	35
2N406	P	G	ETC	210	To 5	20	18	2.5	.035A	.150W	71J	.650B	14UA	6V	35
2N406+	P	G	RCA,TAD	120	To 1	20	18	2.5	.070A	.150W	71J	.650B	14UA	12V	75
2N407	P	G	ETC	210	To 5	20	18	2.5	.070A	.150W	71J	AUD	14UA	12V	65
2N407+	P	G	RCA	55	To 40	20	18	2.5	.070A	.150W	71A	AUD	14UA	12V	65
2N408	P	G	ETC	210	To 5	20	18	2.5	.070A	.150W	71J	AUD	14UA	12V	65
2N408+	P	G	RCA,TAD	120	To 1	20	18	2.5	.070A	.150W	71A	AUD	14UA	12V	65
2N409	P	G	ETC	210	To 5	13	9	.5	.015A	.080W	71J	6.800B	10UA	13V	48
2N409+	P	G	ETC	210	To 5	13	9	.5	.015A	.080W	71A	6.800B	10UA	13V	48
2N410	P	G	ETC	210	To 5	13	10	.5	.015A	.080W	71J	6.800B	10UA	13V	48
2N410+	P	G	RCA	120	To 1	13	10	.5	.015A	.080W	71A	6.800B	10UA	13V	48
2N411	P	G	ETC	210	To 5	13	10	.5	.015A	.080W	71J	10.000B	10UA	13V	75
2N411+	P	G	RCA	120	To 1	13	10	.5	.015A	.080W	71A	10.000B	10UA	13V	75
2N412	P	G	ETC	210	To 5	13	10	.5	.015A	.080W	71J	10.000B	10UA	13V	75
2N412+	P	G	RCA	120	To 1	13	10	.5	.015A	.080W	71A	10.000B	10UA	13V	75
2N413	P	G	ETC,ETC,TAD	210	To 5	30	18	20.0	.200A	-.150W	85A	3.000B	5UA	12V	24
2N413A	P	G	ETC	210	To 5	30	15	20.0	.200A	-.150W	85J	1.000B	5UA	12V	60
2N414	P	G	ETC,RCA,TAD,ETC	210	To 5	30	15	20.0	.200A	-.150W	85J	2.000B	5UA	12V	60
2N414A	P	G	ETC	210	To 5	30	15	20.0	.200A	-.150W	85J	4.000B	5UA	12V	60
2N414B	P	G	ETC	210	To 5	30	15	20.0	.200A						

Transistor Type No.	N P S	Manufacturer	Lead Ident	Out- line	Maximum (V)			Maximum		Max. T.(°C)	Frequency Resp.(MHz)	Leakage		Gain	
					V _{ce}	V _{be}	V _{ce}	I _c	Power			I _{sat}	V _{ce}		I _h @ I _c
2N440	N	TII, TAO, ETC	210	To 5	30	20	25.0	.400A	.150W	85J	12.000B	10UA	25V	70	.050A
2N440A	N	TAO, ETC, GIC	210	To 5	30	15	25.0	.700A	.200W	85J	12.000B	10UA	25V	70	5.000A
2N441	P	DEL, MOT, ETC, SOL, HUG	405	To 36	40	40	20.0	15.000A	150.000W	100C	.010E	4MA	50V	70	5.000A
2N442	P	DEL, MOT, ETC, SOL, HUG	405	To 36	50	45	30.0	15.000A	150.000W	100C	.010E	4MA	50V	30	5.000A
2N443	P	DEL, MOT, ETC, SOL, HUG	405	To 36	60	50	40.0	15.000A	150.000W	100C	.010E	4MA	60V	30	5.000A
2N444	N	CBS	170	To 5	15	15	10.0	.100A	.100W	85J	5.000B	6UA	10V	20	
2N444+	N	ETC	210	To 9	15	15	10.0	.100A	.100W	85J	5.000B	6UA	10V	20	
2N444A	N	ETC	210	To 5	35	25	10.0	.100A	.150W	100J	5.000B	4UA	5V	30	.020A
2N445	N	CBS	170	To 5	15	12	10.0	.100A	.180W	85J	2.000B	6UA	10V	40	
2N445A	N	ETC, GIC	210	To 5	25	18	10.0	.100A	.100W	85J	2.000B	6UA	10V	40	
2N446	N	ETC	210	To 5	15	10	10.0	.100A	.180W	85J	2.000B	6UA	10V	80	.020A
2N446+	N	CBS	170	To 9	15	10	10.0	.100A	.100W	85J	5.000B	6UA	10V	60	
2N445A	N	ETC, GIC	210	To 5	25	15	10.0	.100A	.150W	100J	5.000B	6UA	10V	60	
2N447	N	ETC	170	To 5	15	10	10.0	.100A	.100W	85J	5.000B	6UA	10V	60	.020A
2N447+	N	ETC, GIC	295	295A	45	24	12.0	1.00A	.075W	85A	9.000B	6UA	10V	50	
2N447A	N	ETC, GIC	210	To 5	25	12	10.0	.100A	.150W	100J	9.000B	4UA	5V	155	.020A
2N448	N	ETC	210	To 5	15	15	15	.020A	.065W	85J	2.500B	5UA	15V	34	
2N449	N	ETC	210	To 5	15	15	15	.020A	.065W	85J	5.000B	5UA	15V	34	
2N449+	N	ETC	210	To 5	15	15	15	.020A	.065W	85A	8.000B	5UA	15V	68	.001A
2N450	P	ETC	12	12A	15	15	15	.020A	.065W	85A	5.000B	6UA	12V	60	
2N450+	P	ETC	12	To 5	20	12	10.0	.125A	.150W	85J	5.000B	6UA	12V	60	
2N456	P	BEN, ETC, HUG	57	To 57C	40	40X	20.0	.125A	.150W	85J	5.000B	6UA	12V	30	
2N456A	P	OEL, TII, BEN, ETC, MOT, HUG	605	To 3	40	30	20.0	5.000A	50.000W	100J	.200C	2MA	40V	20	5.000A
2N456B	P	OEL, TII, BEN, ETC, HUG	605	To 3	40	30	20.0	7.000A	150.000W	100J	.200C	500UA	20V	60	5.000A
2N457	P	BEN, ETC, HUG	605	To 3	60	60X	20.0	5.000A	50.000W	95C	.200C	500UA	30V	20	5.000A
2N457A	P	OEL, TII, BEN, ETC, MOT, HUG	605	To 3	60	40	20.0	7.000A	150.000W	100J	.200C	500UA	30V	60	5.000A
2N457B	P	OEL, TII, BEN, ETC, HUG	605	To 3	60	40	20.0	5.000A	50.000W	100J	.200C	500UA	30V	20	5.000A
2N458	P	BEN, ETC, HUG	305	To 3	80	80X	20.0	5.000A	50.000W	100J	.200C	500UA	30V	56	5.000A
2N458A	P	OEL, TII, BEN, ETC, MOT, HUG	605	To 3	80	45	20.0	7.000A	150.000W	100J	.200C	500UA	40V	60	5.000A
2N458B	P	OEL, TII, BEN, ETC, HUG	605	To 3	80	45	30.0	7.000A	150.000W	100J	.200C	500UA	40V	56	5.000A
2N459	P	MOT, ETC	605	To 3	105	60	10.0	5.000A	106.000W	110J	.005E	500UA	25V	34	2.000A
2N459A	P	MOT, ETC	212	To 5	45	35	10.0	.400A	.200W	100J	.005E	500UA	25V	54	2.000A
2N460	P	MOT, TSE, TAO, ETC	212	To 5	45	35R	10.0	.400A	.200W	100J	2.000B	15UA	45V	100	
2N461	P	GEC, MOT, TAO, TSE, ETC	212	To 5	45	35R	10.0	.400A	.200W	100J	2.000B	15UA	45V	100	
2N462	P	GEC, MOT, TAO, TSE, ETC	212	To 5	40	40	40.0	.20A	.150W	75J	5.000B	35UA	35V	40	
2N464	P	MOT, ETC, TAO	210	To 5	40	30	12.0	.100A	.150W	85J	7.000B	20UA	40V	26	
2N465	P	MOT, ETC, TAO, GIC	210	To 5	40	30	12.0	.100A	.150W	85J	8.000B	20UA	40V	26	
2N467	P	MOT, ETC, TAO	210	To 5	35	20	12.0	.100A	.150W	85J	1.000B	20UA	35V	20	
2N470	N	ETC, TEC, HUG	210	To 5	35	15	12.0	.100A	.200W	85J	1.200B	20UA	35V	140	
2N471	N	ETC, TEC, HUG	210	To 5	30	30	2.0	.200W	200J	18.000G	500NA	15V	18		
2N471A	N	ETC, TEC, HUG	210	To 5	35	15	12.0	.100A	.200W	200J	18.000G	500NA	30V	18	
2N472	N	ETC, TEC, HUG	210	To 5	30	30S	2.0	.200W	200J	17.5J	18.000G	500NA	40V	16	
2N472A	N	ETC, TEC, HUG	210	To 5	45	45	2.0	.050A	.200W	200J	18.000G	500NA	45V	18	
2N473	N	ETC, TEC, HUG	210	To 5	45	45S	2.0	.050A	.200W	175J	8.000B	500NA	30V	16	
2N474	N	ETC, TEC, HUG	210	To 5	15	15	2.0	.050A	.200W	200J	18.000G	500NA	15V	16	
2N474A	N	ETC, TEC, HUG	210	To 5	45	45S	2.0	.050A	.200W	175J	8.000B	500NA	30V	16	
2N475	N	ETC, TEC, HUG	210	To 5	45	45S	2.0	.050A	.200W	200J	18.000G	500NA	45V	36	.010A
2N475A	N	ETC, TEC, HUG	210	To 5	45	45S	2.0	.050A	.200W	175J	8.000B	500NA	30V	16	
2N478	N	GEC, ETC, TEC, HUG	210	To 5	15	15	2.0	.200W	175J	8.000B	500NA	45V	15	.010A	
2N479	N	GEC, ETC, TEC, HUG	210	To 5	30	30	2.0	.200W	200J	25.000G	500NA	15V	60		
2N479A	N	GEC, ETC, TEC, HUG	210	To 5	30	30S	2.0	.200W	175J	8.000B	500NA	30V	30	.010A	
2N480	N	ETC, TEC, HUG	210	To 5	45	45S	2.0	.200W	200J	25.000G	500NA	45V	60		
2N480A	N	ETC, TEC, HUG	210	To 5	45	45S	2.0	.200W	175J	8.000B	500NA	30V	30	.010A	
2N481	P	ETC	210	To 5	12	12	5.0	.020A	.150W	85J	1.500B	10UA	2V	60	.010A
2N482	P	ETC	210	To 5	12	12	5.0	.020A	.150W	85J	3.000B	10UA	12V	80	
2N483	P	ETC	210	To 5	12	12	5.0	.020A	.150W	85J	5.000B	10UA	12V	90	
2N484	P	ETC	210	To 5	12	12	5.0	.020A	.150W	85J	9.000B	10UA	12V	100	
2N485	P	ETC	210	To 5	12	12	5.0	.050A	.150W	85J	9.000B	10UA	12V	100	
2N486	P	ETC	120	To 5	12	25	5.0	.050A	.150W	85J	9.000B	10UA	12V	100	
2N495	P	SPR	120	To 1	25	25	5.0	.050A	.150W	140J	100A	10V	23	.001A	
2N496	P	SPR, HUG	120	To 1	10	10	8.0	.050A	.150W	140J	60.000G	10UA	30V	20	.200A
2N497	N	GEC, SSP, TII, RAY, NSC, TEC	211	To 5	60	60	8.0	.200A	.800W	200J	60.000G	10UA	30V	20	.200A
2N497A	N	GEC, SSP, TII, TEC, HUG	211	To 5	60	60	8.0	.200A	.800W	200J	60.000G	10UA	30V	20	.200A
2N498	N	GEC, SSP, TII, RAY, NSC, TEC	211	To 5	100	100	8.0	.200A	.800W	200J	60.000G	10UA	30V	20	.200A
2N498A	N	GEC, SSP, TII, RAY, NSC, TEC	211	To 5	100	100	8.0	.500A	1.000W	200J	60.000G	10UA	30V	20	.200A
2N499	P	ETC, SPR, MOT, HUG	120	To 1	30	18	5.0	.050A	.030W	85J	120.000G	15UA	15V	40	
2N499A	P	ETC, SPR, MOT, HUG	120	To 1	30	18	2.0	.050A	.060W	100J	120.000G	15UA	15V	40	
2N500	P	ETC	170	To 9	15	12S	2.0	.050A	.060W	100J	175.000G	5UA	5V	30	.010A
2N501	P	SPR, ETC, HUG	120	To 1	15	12S	2.0	.050A	.060W	100J	120.000G	5UA	5V	30	.050A
2N501+18	P	SPR, ETC, HUG	211	To 18	15	12S	2.0	.200A	.150W	100J	50.000G	100UA	15V	40	
2N502	P	SPR, ETC, MOT, HUG	170	To 9	20	20	5.0	.100A	.060W	100J	175.000G	5UA	5V	45	.010A
2N502A	P	SPR, ETC, MOT, HUG	170	To 9	30	30	5.0	.100A	.075W	100J	260.000G	5UA	10V	30	
2N502B	P	SPR, ETC, MOT, HUG	170	To 9	30	30	5.0	.100A	.075W	100J	260.000G	5UA	10V	40	
2N503	P	SPR, ETC, HUG	120	To 1	35	20S	5.0	.050A	.025W	85J	168.000G	5UA	10V	15	
2N504	P	SPR, ETC, HUG	120	To 1	35	20S	5.0	.050A	.040W	85J	50.000F	10UA	15V	60	
2N505	P	ETC	210	To 5	40	40	40.0	.250A	.125W	85J	5.000B	10UA	25V	60	
2N506	P	ETC	210	To 5	40	40	40.0	.100A	.050W	85J	6.000B	15UA	30V	50	
2N507	N	ETC	210	To 5	40	40	40.0	.100A	.050W	85J	6.000B	125UA	40V	36	
2N508	P	GEC, TAO, ETC, MOT, TII	212	To 5	18	16	5.0	.200A	.200W	85J	4.500B	7UA	25V	120	.020A
2N508A	P	GEC, MOT	212	To 5	30	30	10.0	.200A	.200W	85J	2.500B	7UA	25V	120	.020A
2N511	P	BEN, TII, ETC, SOL, HUG	607	To 41	60	40	30.0	25.000A	150.000W	100J	2.50G	5UA	40V	40	
2N511A	P	BEN, TII, ETC, SOL, HUG	607	To 41	60	40	30.0	25.000A	150.000W	100J	2.50G	5UA	60V	40	
2N511B	P	BEN, TII, ETC, SOL, HUG	607	To 41	80	45	30.0	25.000A	150.000W	100J	2.50G	5UA	80V	40	
2N512	P	BEN, TII, ETC, SOL, HUG	607	To 41	40	30	30.0	25.000A	150.000W	100J	2.70G	5UA	40V	40	
2N512B	P	BEN, TII, ETC, SOL, HUG	607	To 41	60	40	30.0	25.000A	150.000W	100J	2.70G	5UA	60V	40	
2N513	P	BEN, TII, ETC, HUG	607	To 41	80	45	30.0	25.000A	150.000W	100J	2.70G	5UA	80V	40	
2N513A	P	BEN, TII, ETC, HUG	607	To 41	60	40	30.0	25.000A	150.000W	100J	3.00G	5UA	40V	40	
2N513B	P	BEN, TII, ETC, HUG	607	To 41	80	45	30.0	25.000							

Transistor Type No.	M / P / S	Manufacturer	Lead Ident	Out- line	Maximum (V)			Maximum		Max T.(°C)	Frequency Resp.(MHz)	Leakage		Gain	
					V _{ce}	V _{cs}	V _{es}	I _c	Power			I _{cs} @ V _{cs}	I _{es} @ V _{es}	β_{dc}	β_{ac}
2N521A	P	ETC,GIC	210	To 5	25	12	10.0		.150W	100J	8.000B	25UA	20V	160	.020A
2N522	P	ETC	210	To 5	15	8	10.0	.200A	.200W	100J	15.000B	25UA	15V	130	
2N522A	P	ETC,GIC,TII	210	To 5	25	10	10.0		.150W	100J	15.000B	25UA	20V	200	.020A
2N523	P	ETC,GIC,TII	210	To 5	25	10	10.0	.200A	.200W	100J	21.000B	25UA	15V	160	
2N523A	P	ETC,GIC	210	To 5	25	10	10.0		.150W	100J	21.000B	25UA	15V	250	.020A
2N524	P	CSF,GEC,MOT,ETC,TAD,TII	211	To 5	45	30R	15.0	.500A	.225W	85J	2.500B	10UA	30V	34	.020A
2N525	P	MOT	212	To 5	45	30	15.0	.500A	.225W	85J	3.000B	10UA	30V	44	
2N525A	P	CSF,GEC,MOT,ETC,TAD,TII	212	To 5	45	30	15.0	.500A	.225W	85J	1.000B	10UA	30V	50	.020A
2N525B	P	CSF,GEC,MOT,ETC,TAD,TII	212	To 5	45	30	15.0	.500A	.225W	85J	3.500B	10UA	30V	54	
2N526	P	CSF,GEC,MOT,ETC,TAD,TII	211	To 5	45	30	15.0	.500A	.225W	85J	1.300B	10UA	30V	72	.020A
2N526A	P	MOT	211	To 5	45	30	15.0	.500A	.225W	85J	4.000B	10UA	30V	80	
2N527	P	CSF,GEC,MOT,ETC,TAD,TII	212	To 5	45	30	15.0	.500A	.225W	100J	1.500B	10UA	30V	96	.020A
2N527A	P	MOT	211	To 5	15	15	5.0		.100W	85J	2.500B	5UA	5V	18	.001A
2N529	P	ETC	210	To 5	15	15	5.0		.100W	85J	2.500B	5UA	5V	15	.001A
2N529/P	P	ETC	210	To 5	15	15	5.0		.100W	85J	3.000B	5UA	5V	22	.001A
2N530/N	P	ETC	210	To 5	15	15	5.0		.100W	85J	3.000B	5UA	5V	22	.001A
2N530/P	P	ETC	210	To 5	15	15	5.0		.100W	85J	3.500B	5UA	5V	28	.001A
2N531/P	P	ETC	210	To 5	15	15	5.0		.100W	85J	4.000B	5UA	5V	32	.001A
2N532/N	P	ETC	210	To 5	15	15	5.0		.100W	85J	4.000B	5UA	5V	32	.001A
2N532/P	P	ETC	210	To 5	15	15	5.0		.100W	85J	4.500B	5UA	5V	38	.001A
2N533/N	P	ETC	210	To 5	15	15	5.0		.100W	85J	4.500B	5UA	5V	38	.001A
2N533/P	P	ETC	210	To 5	15	15	5.0		.100W	85J	5.000B	5UA	5V	40	.001A
2N534	P	PHL	116	To 23	50	20	20.0	.025A	.025W	65J	1.500B	10UA	12V	131	
2N535	P	ETC	210	To 5	20	20	20.0	.020A	.050W	85J	1.000B	10UA	12V	139	
2N535A	P	ETC	210	To 5	20	20	20.0	.020A	.050W	85J	1.000B	10UA	12V	139	
2N536	P	ETC	210	To 5	20	20	20.0	.030A	.050W	85J	1.000B	10UA	12V	185	
2N536 +	P	PHL	116	To 23	20	20	20.0	.030A	.050W	85J	1.000B	10UA	12V	185	
2N538	P	SOL,HUG	427	To 10	80	60	28.0	3.500A	30.000W	100J	200.000G	2MA	80V	32	2.000A
2N538A	P	SOL,HUG	427	To 10	80	60	28.0	3.500A	30.000W	100J	200.000G	2MA	80V	34	2.000A
2N539	P	SOL,HUG	427	To 10	80	55	28.0	3.500A	30.000W	100J	200.000G	2MA	80V	48	2.000A
2N539A	P	SOL,HUG	427	To 10	80	55	28.0	3.500A	30.000W	100J	200.000G	2MA	80V	74	2.000A
2N540	P	SOL,HUG	427	To 10	80	55	28.0	3.500A	30.000W	100J	200.000G	2MA	80V	74	2.000A
2N540A	P	SOL,HUG	427	To 10	80	55	28.0	3.500A	30.000W	100J	200.000G	2MA	80V	74	2.000A
2N541	N	GEC,ETC,TII,TEC	210	To 5	15	15	2.0		.200W	200J	25.000G	500NA	15V	142	
2N542	N	GEC,ETC,TII,TEC,HUG	210	To 5	30	30	2.0		.200W	175J	8.000B	500NA	30V	140	.010A
2N542A	N	GEC,ETC,TII,TEC,HUG	210	To 5	30	30	2.0		.200W	200J	25.000G	500NA	15V	140	
2N543	N	GEC,ETC,TII,TEC,HUG	210	To 5	45	45	2.0		.200W	175J	8.000B	500NA	45V	60	.010A
2N543A	N	ETC,TEC,HUG	210	To 7	18	18	1.0	.010A	.080W	85J	30.000B	4UA	12V	80	
2N544	P	RCA	217	To 33	24	1.0		.010A	.080W	100J	30.000B	24UA	50V	80	
2N544/33	P	SVL	210	To 5	60	6.0		.800A	.600W	200J	13.000G	15UA	10V	300	
2N545	N	SSP,TEC,HUG	210	To 5	60	6.0		.800A	.600W	200J	4.000G	15UA	60V	50	
2N546	N	SSP,TEC,HUG	210	To 5	60	6.0		.800A	.600W	200J	4.000G	15UA	60V	50	.200A
2N547	N	SSP,ETC,TEC,HUG	210	To 5	30	30	6.0	.800A	.600W	200J	4.000G	15UA	60V	50	.200A
2N548	N	SSP,ETC,TEC,HUG	210	To 5	60	6.0		.800A	.600W	200J	4.000G	15UA	60V	50	.200A
2N549	N	SSP,ETC,TEC,HUG	210	To 5	60	6.0		.800A	.600W	200J	4.000G	15UA	60V	50	.200A
2N550	N	ETC,TEC,HUG	210	To 5	30	30	6.0	.800A	.600W	200J	3.000G	15UA	60V	50	.050A
2N551	N	SSP,ETC,TEC,HUG	210	To 5	30	30	6.0	.200A	.600W	200J	3.000G	15UA	30V	50	.050A
2N552	N	ETC,ETC,HUG	605	To 3	80	40	40.0	4.000A	50.000W	95J	.025E	2MA	60V	70	1.000A
2N553	P	BEN,ETC,HUG	605	To 3	30	15.0		5.000A	60.000W	110J	.005E	10MA	15V	100	
2N554	P	OEL,MOT,BEN,ETC,HUG	605	To 3	40	20.0		3.000A	65.000W	200J	.008E	7MA	30V	40	
2N555	P	MOT,BEN,ETC,HUG	605	To 3	25	20R	10.0	.200A	.100W	85J	1.000B	10UA	25V	50	
2N556	N	GIC	210	To 5	25	20R	10.0	.200A	.100W	85J	MS SW	5UA	20V	40	
2N557	N	ETC	210	To 5	15	15R	15.0	.200A	.100W	85J	MS SW	10UA	10V	30	
2N558	P	MOT	210	To 5	15	15S	5.0	.050A	.150W	100J	300.000G	3UA	1V	54	.010A
2N559	P	MOT	210	To 210J	15	15S	5.0	.100A	.600W	200J	1000A	20V	30	1.000A	
2N560	N	NSC,NSC,HUG	210	To 5	80	50	60.0	10.000A	50.000W	100J	.005E	500UA	30V	32	4.000A
2N561	P	BEN,ETC,HUG	210	To 5	30	25	10.0	.300A	.150W	85J	.400B	5UA	10V	20	
2N562	P	ETC	210	To 5	30	25	10.0	.300A	.120W	85J	.400B	5UA	10V	20	
2N564	P	ETC	210	To 5	30	25	10.0	.300A	.150W	85J	.500B	5UA	10V	36	
2N565	P	ETC	210	To 5	30	25	10.0	.300A	.120W	85J	.500B	5UA	10V	36	
2N566	P	ETC	210	To 5	30	25	10.0	.300A	.150W	85J	.700B	5UA	10V	60	
2N567	P	ETC	210	To 5	30	25	10.0	.300A	.150W	85J	.750B	5UA	10V	60	
2N568	P	ETC	210	To 5	30	15	10.0	.300A	.120W	85J	1.000B	5UA	10V	80	
2N569	P	ETC	210	To 5	30	15	10.0	.300A	.120W	85J	1.000B	5UA	10V	80	
2N57	P	ETC	210	To 5	30	15	10.0	.300A	.120W	85J	1.000B	5UA	10V	80	
2N572	P	ETC	480	480A	60	55	28.0	10.000A	187.000W	100J	.100G	7MA	60V	15	10.00A
2N574	P	SOL,HUG	480	480A	80	60	28.0	10.000A	187.000W	100J	.100G	20MA	80V	15	10.00A
2N574A	P	SOL,HUG	480	480A	80	50	28.0	25.000A	187.000W	100J	1.50G	7MA	60V	30	10.00A
2N575	P	SOL,HUG	480	480A	80	55	28.0	25.000A	187.000W	100J	.150G	20MA	80V	30	10.00A
2N575A	P	SOL	480	480A	20	50X	15.0	.400A	.200W	100J	8.000B	10UA	25V	35	.400A
2N576	N	ETC	212	To 5	40	40X	15.0	.400A	.200W	100J	10.000B	40UA	40V	35	.400A
2N576A	N	ETC	210	To 9	20	14	12.0	.400A	.120W	71J	3.000B	5UA	12V	15	.400A
2N578	P	ETC	170	To 9	20	14	12.0	.400A	.120W	71J	5.000B	5UA	12V	15	.400A
2N578 +	P	ETC	170	To 9	20	14	12.0	.400A	.120W	71J	5.000B	5UA	12V	36	.400A
2N579	P	ETC,GIC	170	To 9	20	14	12.0	.400A	.120W	71J	8.000B	5UA	12V	30	
2N579 +	P	ETC,GIC	210	To 5	20	14	12.0	.400A	.120W	71J	10.000B	5UA	12V	44	.400A
2N580	P	TAD	170	To 9	20	14	12.0	.400A	.120W	71J	15.000B	5UA	12V	44	.400A
2N581	P	RCA,TAD,ETC,TII	210	To 5	15	15	10.0	.100A	.150W	85J	4.000B	10UA	12V	30	.020A
2N582	P	ETC,RCA,TAD,TII	210	To 5	18	15	10.0	.100A	.120W	85J	4.000B	10UA	12V	40	.024A
2N583	P	ETC,RCA,TAD,TII	120	To 1	18	15	10.0	.100A	.120W	85J	8.000B	10UA	12V	40	
2N584	P	RCA	120	To 1	18	15	10.0	.100A	.120W	85J	14.000B	5UA	12V	60	.024A
2N584 +	P	RCA	120	To 1	25	14R	12.0	.100A	.120W	85J	18.000B	5UA	12V	60	.020A
2N585	P	ETC,GIC	170	To 9	25	24	20.0	.200A	.120W	85J	3.000B	8UA	12V	30	
2N585 +	N	RCA,TAD	210	To 5	25	15	20.0	.200A	.120W	85A	2.500B	8UA	12V	40	
2N586	P	ETC,RCA	210	To 5	45	25	12.0	.250A	.050W	85J	MS SW	15UA	10V	60	
2N587	N	ETC,TAD,TII	212	To 5	40	30	40.0	.700W	.200W	100J	MS SW	10UA	40V	30	.200A
2N588	P	HUG,ETC,HUG	120	To 1	15	15S	.5	.050A	.040W	85J	200.000F	15UA	15V	45	.010A
2N588B	P	HUG,ETC,HUG	120	To 1	15	15S	.5	.050A	.060W	85J	200.000F	7UA	1V	70	
2N591	P	ETC	210	To 5	32	32R		.040A	.050W	85J	7.000B	7UA	1V	70	
2N591 +	P	RCA	120	To 5	35	32R		.050A	.055W	85					

Transistor Type No.	N P	G S	Manufacturer	Lead Ident	Out. line	Maximum (V)			Maximum		Max. T.C.(°C)	Frequency Resp.(MHz)	Leakage I _{em} @ V _{em}	Gain h _{fe} @ I _c		
						V _{em}	V _{cs}	V _{es}	I _c	Power						
2N605	-P	G	GTC	170	TO 9	15	15		.120W	85J	AM RF	10UA	12V	70		
2N606	-P	G	GTC	170	TO 9	15	15		.120W	85J	AM RF	10UA	12V	100		
2N607	-P	G	GTC	170	TO 9	15	15		.120W	85J	AM RF	10UA	12V	100		
2N608	-P	G	GTC	210	TO 5	25	20	10.0	200A	.120W	AM RF	10UA	12V	150		
2N610	-P	G	ETC	210	TO 5	25	20	10.0	200A	.180W	85J	AUD	15UA	20V	65	
2N611	-P	G	ETC	210	TO 5	25	20	10.0	200A	.180W	85J	AUD	15UA	20V	65	
2N612	-P	G	ETC	210	TO 5	25	20	10.0	200A	.180W	85J	AUD	15UA	20V	65	
2N613	-P	G	ETC	210	TO 5	25	20	10.0	200A	.180W	85J	AUD	15UA	20V	65	
2N614	-P	G	ETC	210	TO 5	20	15	10.0	150A	.125W	85J	3.000B	6UA	20V	45	
2N615	-P	G	ETC	210	TO 5	20	15	10.0	150A	.125W	85J	3.000B	6UA	20V	45	
2N616	-P	G	ETC	210	TO 5	15	12	10.0	150A	.125W	85J	6.000B	6UA	15V	45	
2N617	-P	G	ETC	210	TO 5	15	12	10.0	150A	.125W	85J	6.000B	6UA	15V	45	
2N618	-P	G	BEN.MOT.ETC,HUG	605	TO 3	80	60S	25.0	3.000A	90.000W	100J	0.05E	3MA	50V	90	
2N623	-P	G	TI1	210	TO 5	30	15	1.0	.020A	.040W	85J	90.000B	10UA	20V	36	
2N624	-P	G	SVL	217	TO 33	30	20S		.010A	.100W	100J	20.000B	10UA	5V	40	
2N625	-P	G	ETC	173	TO 8	40	30S	30.0	.500A	2.000W	100J	MS SW	100UA	40V	60	
2N628	-P	G	MOT.BEN,HUG	607	TO 41	60	45S	30.0	10.000A	90.000W	100J	.005E	20MA	40V	20	
2N629	-P	G	MOT.BEN,HUG	607	TO 41	60	45S	30.0	10.000A	90.000W	100J	.005E	20MA	40V	20	
2N630	-P	G	MOT.BEN,HUG	607	TO 41	60	45S	30.0	10.000A	90.000W	100J	.005E	20MA	40V	20	
2N631	-P	G	ETC	607	TO 41	5	100	75S	50.0	10.000A	90.000W	100J	.005E	20MA	100V	20
2N632	-P	G	ETC	210	TO 5	30	25	6.0	.200A	.170W	85J	.600B	25UA	20V	150	
2N633	-P	G	ETC	210	TO 5	30	25	6.0	.200A	.150W	85J	.500B	25UA	20V	100	
2N634	-P	G	ETC	210	TO 5	35	20	6.0	.200A	.150W	85J	.500B	25UA	20V	100	
2N634A	-P	G	ETC,TAO,TI1	212	TO 5	20	20R	15.0	.300A	.150W	85J	5.000B	5UA	5V	30	
2N635	-P	G	ETC	212	TO 5	25	20R	25.0	.300A	.150W	85J	5.000B	5UA	5V	30	
2N635A	-P	G	ETC,TAO,TI1	212	TO 5	25	20R	25.0	.300A	.150W	85J	10.000B	5UA	5V	30	
2N636	-P	G	ETC	212	TO 5	20	15R	15.0	.300A	.150W	85J	15.000B	5UA	5V	30	
2N636A	-P	G	ETC, TI1	212	TO 5	25	15R	25.0	.300A	.150W	85J	15.000B	5UA	5V	30	
2N637	-P	G	BEN,ETC,HUG	605	TO 3	90	55	15.0	5.000A	90.000W	110J	.004E	10MA	100V	40	
2N637A	-P	G	BEN,ETC,HUG	605	TO 3	90	55	15.0	5.000A	90.000W	100J	.004E	10MA	100V	40	
2N637B	-P	G	BEN,ETC,HUG	605	TO 3	100	65	15.0	5.000A	90.000W	100J	.004E	200UA	2V	46	
2N638	-P	G	BEN,ETC,HUG	605	TO 3	60	30	15.0	5.000A	90.000W	100J	.004E	200UA	2V	30	
2N638A	-P	G	BEN,ETC,HUG	605	TO 3	90	55	15.0	5.000A	90.000W	100J	.004E	200UA	2V	30	
2N638B	-P	G	BEN,ETC,HUG	605	TO 3	100	60	15.0	5.000A	90.000W	100J	.004E	200UA	2V	30	
2N639	-P	G	ETC	605	TO 3	25	40R	1.5	5.000A	25.000W	100J	1MA	25V	3.000A		
2N639A	-P	G	ETC	605	TO 3	60	70R	1.5	5.000A	25.000W	100J	1MA	60V	22		
2N639B	-P	G	ETC	605	TO 3	60	80R	1.5	5.000A	25.000W	100J	1MA	60V	22		
2N640	-P	G	RCA	75	TO 7	34			.010A	.080W	71J	40.000B	5UA	12V	60	
2N641	-P	G	RCA	171	TO 9	30	29	2.0	.100A	.120W	71A	40.000B	7UA	12V	60	
2N642	-P	G	RCA	217	TO 12	30			.100A	.120W	71A	40.000B	7UA	12V	60	
2N643	-P	G	RCA	217	TO 12	30			.100A	.120W	71A	40.000B	7UA	12V	60	
2N644	-P	G	RCA	210	TO 5	25	12.0		.050A	.100W	71A	60.000G	10UA	7V	40	
2N645	-P	G	RCA	120	TO 1	20	18	2.5	.050A	.100W	71A	AUD	14UA	12V	65	
2N647	-P	G	RCA	210	TO 5	45	30	30.0	.500A	.200W	100J	1.500B	50UA	45V	50	
2N649	-P	G	MOT,TAO,ETC	210	TO 5	45	30	30.0	.500A	.200W	100J	.750B	50UA	45V	50	
2N650	-P	G	TI1,ETC,MOT	210	TO 5	45	30	30.0	.500A	.200W	100J	1.500B	50UA	45V	50	
2N651	-P	G	MOT,ETC,TAO	210	TO 5	45	30	30.0	.500A	.200W	100J	1.500B	50UA	45V	50	
2N651A	-P	G	TI1,ETC,MOT	210	TO 5	45	30	30.0	.500A	.200W	100J	1.500B	50UA	45V	50	
2N652	-P	G	MOT,ETC,TAO	210	TO 5	45	30	30.0	.500A	.200W	100J	2.500B	50UA	45V	120	
2N652A	-P	G	TI1,ETC,MOT	210	TO 5	45	30	30.0	.500A	.200W	100J	2.500B	50UA	45V	120	
2N653	-P	G	MOT,ETC,TAO	210	TO 5	30	25R	25.0	.250A	.200W	100J	1.500B	15UA	30V	44	
2N654	-P	G	ETC	210	TO 5	30	25R	25.0	.250A	.200W	100J	1.500B	15UA	30V	44	
2N654+	-P	G	MOT,TAO	210	TO 5	30	25	15.0	.250A	.200W	100J	2.500B	15UA	25V	90	
2N655	-P	G	ETC	210	TO 5	30	25R	25.0	.250A	.200W	100J	2.500B	15UA	25V	140	
2N655+	-P	G	MOT,TAO	210	TO 5	30	25R	25.0	.250A	.200W	100J	2.500B	15UA	25V	140	
2N656	-P	G	ETC	210	TO 5	30	25	15.0	.250A	.200W	100J	2.500B	15UA	25V	160	
2N656A	-P	G	MOT,TAO	210	TO 5	30	25R	25.0	.250A	.200W	100J	2.500B	15UA	25V	160	
2N657	-P	G	ETC	211	TO 5	60	60	8.0	.500A	.800W	200J	AUD	10UA	30V	60	
2N657A	-P	G	ETC	211	TO 5	100	100	8.0	.500A	.800W	200J	20.000B	10UA	30V	60	
2N658	-P	G	FSC,GEC,SSP,ETC,NSC,TI1	211	TO 5	100	100	8.0	.500A	.800W	200J	AUD	10UA	30V	60	
2N658A	-P	G	FSC,GEC,SSP,ETC,NSC,TI1,TEC	211	TO 5	100	100	8.0	.500A	.800W	200J	20.000B	10UA	30V	60	
2N658B	-P	G	FSC,GEC,SSP,ETC,NSC,TI1,TEC	211	TO 5	100	100	8.0	.500A	.800W	200J	20.000B	10UA	30V	60	
2N659	-P	G	ETC	210	TO 5	30	16	12.0	1.000A	.700W	100J	15.000B	5UA	12V	40	
2N660	-P	G	TAO,TI1,ETC	210	TO 5	30	14	12.0	1.000A	.700W	100J	15.000B	5UA	12V	100	
2N661	-P	G	TAO,TI1,ETC	210	TO 5	30	9	12.0	1.000A	.700W	100J	20.000B	5UA	12V	120	
2N662	-P	G	TAO,TI1,ETC	210	TO 5	30	14	12.0	1.000A	.700W	100J	8.000B	5UA	12V	70	
2N663	-P	G	ETC,HUG	605	TO 3	50	25	20.0	4.000A	35.000W	100J	.020E	4MA	50V	70	
2N665	-P	G	ETC	605	TO 3	80	40.0		5.000A	35.000W	100J	.020E	6MA	50V	60	
2N669	-P	G	DEL,MOT,BEN,ETC,HUG	605	TO 3	40	10.0		3.000A	40.000W	100J	.003E	65UA	12V	90	
2N670	-P	G	PHL	172	TO 172A	26	25		2.000A	.300W	85J	.500B	75UA	12V	80	
2N671	-P	G	PHL	172	TO 26	40			2.000A	1.000W	85J	.500B	75UA	12V	80	
2N672	-P	G	PHL	172	TO 172A	26	25		2.000A	.300W	85J	.500B	75UA	12V	80	
2N673	-P	G	PHL	172	TO 26	25			2.000A	1.000W	85J	.500B	75UA	12V	80	
2N677	-P	G	BEN,ETC,SOL,HUG	605	TO 3	50	20	10.0	15.000A	90.000W	100J	.004E	2MA	15V	40	
2N677A	-P	G	BEN,ETC,SOL,HUG	605	TO 3	60	30	15.0	15.000A	90.000W	100J	.004E	2MA	15V	40	
2N677B	-P	G	BEN,ETC,SOL,HUG	605	TO 3	90	60	15.0	15.000A	90.000W	100J	.004E	2MA	15V	40	
2N677C	-P	G	BEN,ETC,SOL,HUG	605	TO 3	100	70	15.0	15.000A	90.000W	100J	.004E	2MA	15V	40	
2N678	-P	G	BEN,ETC,SOL,HUG	605	TO 3	50	20	10.0	15.000A	90.000W	100J	.004E	2MA	15V	40	
2N678A	-P	G	BEN,ETC,SOL,HUG	605	TO 3	90	60	15.0	15.000A	90.000W	100J	.004E	2MA	15V	40	
2N678B	-P	G	BEN,ETC,SOL,HUG	605	TO 3	100	70	15.0	15.000A	90.000W	100J	.004E	2MA	15V	40	
2N678C	-P	G	BEN,ETC,SOL,HUG	605	TO 3	100	70	15.0	15.000A	90.000W	100J	.004E	2MA	15V	40	
2N679	-P	G	ETC	210	TO 5	25	20R	15.0	.200A	.150W	85J	2.000B	25UA	25V	40	
2N680	-P	G	ETC	210	TO 5	15	15	20.0	.100A	.150W	85J	AUD	14UA	20V	30	
2N695	-P	G	MOT	210	TO 17				.050A	.075W	100J	250.000G	3UA	6V	40	
2N696	-P	G	ETC	211	TO 5	60	40R	5.0	.600W	175A	50.000G	1UA	30V	40		
2N697	-P	G	ETC	211	TO 5	120	60	7.0	.800W	200A	40.000G	5UA	75V	30		
2N698	-P	G	ETC	211	TO 5	120	80R	5.0	.600W	175A	50.000G	1UA	30V	40		
2N699	-P	G	ETC	211	TO 5	120	80R	5.0	.600W	175A	50.000G	1UA	30V	40		
2N699A	-P	G	ETC	211	TO 5	120	80R	5.0	.600W	175A	50.000G	1UA	30V	40		
2N699B	-P	G	ETC	211	TO 5	120	80R	5.0	.600W	175A	50.000G	1UA	30V	40		
2N700	-P	G	ETC	211	TO 5	120	80									

Transistor Type No.	N P S	G S	Manufacturer	Lead Ident	Out- line	Maximum (V)			Maximum I _c	Maximum Power	Max. T _j (°C)	Frequency Resp.(MHz)	Leakage		Gain		
						V _{CE}	V _{BE}	V _{ES}					I _{ES} @ V _{CE}	I _{ES} @ I _c			
2N708	N	S	RAY, MOT, AEI, AMP, ITT, GEC	211	TO 18	40	15	5.0		.360W	200J	300.000G	25NA	20V	60	.010A	
2N708/46	N	S	SYL	211	TO 46	40	15R	5.0		.400W	200J	300.000G	25SU	20V	80		
2N708/51	N	S	SYL	910	TO 51	40	15R	6.0		.300W	200J	300.000G	25UA	20V	80		
2N708A	N	S	GIC	211	TO 18	50	30	5.0		.360W	200J	300.000G	50NA	5V	70	.010A	
2N709	N	S	FSC, RCA, RAY, TEC, GEC, TII	211	TO 18	15	6	4.0	.100A	.300W	200J	600.000G	50NA	5V	70	.010A	
2N709A	N	S	FSC, GEC, FSC, HUG	211	TO 18	15	6	4.0		.300W	200J	800.000G	50NA	5V	60	.010A	
2N710	P	G	ITT	211	TO 18	15	15S	2.0	.050A	.150W	100J	100.000G	3UA	5V	40		
2N711	P	G	ITT	211	TO 18	15	7	1.5	.100A	.150W	100J	200.000G	2UA	5V	60	.010A	
2N711A	P	G	ITT	211	TO 18	15	7	2.0	.100A	.150W	100J	200.000G	2UA	5V	70	.010A	
2N711B	P	G	ITT	211	TO 18	18	7	2.0	.100A	.150W	100J	200.000G	1UA	30V	40	.150A	
2N715	N	S	GEC, TRW, RAY, TII, SES, ETC	211	TO 18	60	40R	5.0		.400W	100J	60.000G	1UA	30V	80	.150A	
2N718	N	S	AMC, GEC, ITT, RAY, TII, TRW	211	TO 18	60	40R	5.0		.400W	200J	60.000G	10NA	60V	80	.150A	
2N718A	N	S	GEC, TII, MOT, TRW, RCA, SES	211	TO 18	120	80R	5.0		.400W	175J	40.000G	2UA	60V	40	.150A	
2N719	N	S	GEC, TRW, RAY, TII, SES, ETC	211	TO 18	120	60R	7.0		.400W	200J	40.000G	10NA	75V	40	.150A	
2N720	N	S	AMC, GEC, TII, TRW, SES, ETC	211	TO 18	120	80R	5.0		.400W	200J	60.000G	2UA	60V	80		
2N720A	N	S	GEC, TRW, RAY, TII, SES, ETC	211	TO 18	120	80R	5.0		.400W	200J	60.000G	10NA	90V	80		
2N721	N	S	AMC, GEC, HUG, RAY, RCA, TRW	211	TO 18	50	50R	5.0		.400W	175J	50.000G	1UA	30V	26	.150A	
2N722	N	S	RAY, TII, TEC, MOT, HUG	211	TO 18	50	50R	5.0		.500W	200J	50.000G	100NA	30V	26	.150A	
2N722A	P	S	HUG, MOT, ETC, RAY, NSC, TII	211	TO 18	50	35	5.0		.400W	200J	60.000G	100UA	50V	50		
2N725	P	S	HUG	211	TO 18	50	35	5.0		.500W	200J	50.000G	3UA	5V	48		
2N725A	P	S	GEC	211	TO 18	20	20	5.0	.050A	.150W	100J	600.000G	10UA	25V	30		
2N726	P	S	ITT, TEC	211	TO 18	25	20	5.0		.300W	175J	200.000G	1UA	25V	74		
2N727	P	S	ITT, TEC	211	TO 18	25	20	5.0		.300W	175J	140.000G	5UA	15V	48		
2N728	N	S	TEC, HUG	210	TO 18	15	15	3.0		.600W	175J	100.000G	5UA	15V	40		
2N729	N	S	TEC, HUG	210	TO 18	60	40R	5.0		.500W	175J	40.000G	1UA	30V	40		
2N730	N	S	ITT, ETC, RAY, NSC, TEC, HUG	211	TO 18	60	40R	5.0		.500W	175J	50.000G	1UA	30V	80		
2N731	N	S	ITT, ETC, RAY, NSC, TEC, HUG	211	TO 18	60	40R	5.0		.500W	175J	60.000G	1UA	30V	40		
2N734	N	S	TII, TRW, ETC, SOL, TEC, HUG	211	TO 18	80	60	5.0	.500A	.500W	175J	60.000G	5NA	50V	32	.005A	
2N734A	N	S	SOL	211	TO 18	80	60	6.0	.500A	.500W	175J	60.000G	1UA	40V	80		
2N735	N	S	TII, TRW, ETC, NSC, SOL, TEC	210	TO 18	80	60	6.0	.400W	.200J	60.000G	5NA	50V	80			
2N735A	N	S	ETC, NSC, SOL, HUG	211	TO 18	80	60	5.0	.500A	.500W	175J	60.000G	500NA	40V	110	.005A	
2N736	N	S	TII, TRW, ETC, NSC, SOL, TEC	211	TO 18	80	60	5.0	.100A	.400W	200J	100.000G	5NA	50V	130	.005A	
2N736A	N	S	SSD, ETC, SOL, HUG	210	TO 18	80	60	8.0		.500W	175J	60.000G	1UA	40V	40	.005A	
2N736B	N	S	SSD, ETC, SOL, HUG	210	TO 18	125	80	5.0		.500W	175J	60.000G	5NA	50V	80	.005A	
2N738	N	S	AMC, TII, ETC, SOL, TEC, MOT	211	TO 18	125	80	8.0	.050A	.400W	200J	30.000G	5NA	50V	80	.005A	
2N738A	N	S	AMC, TII, ETC, SOL, TEC, MOT	211	TO 18	125	80	5.0		1.800W	175J	60.000G	1UA	40V	80	.005A	
2N739	N	S	SOL, HUG	210	TO 18	125	80	8.0		.500W	175J	60.000G	1UA	40V	130	.005A	
2N739A	N	S	AMC, TII, ETC, SOL, SSD, TEC	210	TO 18	125	80	5.0		.500W	200J	100.000G	5NA	80V	120	.005A	
2N740	N	S	SSD, SOL, HUG	210	TO 18	15	15	1.0	.100A	.150W	100J	300.000G	3UA	6V	24		
2N740A	N	S	SSD, SOL, HUG	210	TO 18	20	20	1.0	.100A	.150W	100J	300.000G	100NA	20V	50		
2N741	N	S	NSC, ETC	210	TO 18	60	50	12	.200A	.300W	175J	300.000G	1UA	20V	40	.010A	
2N742	N	S	ITT, TII, GEC, GIC, AMP, SES	211	TO 18	40	15	5.0		.360W	200J	500.000G	1UA	20V	40	.010A	
2N743	N	S	GEC, RAY	211	TO 18	20	12	5.0	.200A	.300W	175J	300.000G	1UA	20V	80	.010A	
2N743A	N	S	ITT, RAY, TII, GEC, GIC, MOT	211	TO 18	20	12	5.0		.300W	175J	300.000G	1UA	20V	60	.010A	
2N744	N	S	GEC, RAY	211	TO 18	40	15	5.0		.300W	175J	200.000G	10UA	25V	80	.010A	
2N744A	N	S	AEI, GEC, ITT, TII, MOT, GIC	210	TO 18	60	80	8.0	.050A	.300W	175J	35.000G	1UA	60V	40	.005A	
2N753	N	S	TEC, HUG	210	TO 18	100	80	8.0		.300W	200J	35.000G	1UA	100V	40	.005A	
2N754	N	S	TEC, HUG	210	TO 18	45	45	6.0		.500W	200J	50.000G	100NA	20V	17	.001A	
2N755	N	S	SOL, TEC, HUG	210	TO 18	60	60	6.0		.500W	200J	50.000G	100NA	20V	17	.001A	
2N756	N	S	SOL, TEC	210	TO 18	45	45	6.0		.500W	200J	50.000G	100NA	20V	28	.001A	
2N756A	N	S	SOL, TEC	210	TO 18	60	60	6.0		.500W	200J	50.000G	100NA	20V	28	.001A	
2N757	N	S	SOL, TEC, HUG	210	TO 18	45	45	6.0		.500W	200J	50.000G	200NA	10V	40	.001A	
2N757A	N	S	SOL, TEC, HUG	210	TO 18	60	60	8.0	.100A	.500W	200J	50.000G	2UA	45V	18	.001A	
2N758	N	S	SOL, TEC, HUG	210	TO 18	45	45	6.0		.500W	200J	50.000G	100NA	30V	50	.001A	
2N758A	N	S	SOL, TEC, HUG	210	TO 18	60	60	8.0	.100A	.500W	200J	50.000G	100NA	30V	50	.001A	
2N758B	N	S	SOL, HUG	211	TO 18	45	45	8.0		.400W	200J	50.000G	5NA	30V	50	.001A	
2N759	N	S	AEI, GEC, NSC, TII, SOL, TEC	211	TO 18	60	60	8.0	.100A	.500W	200J	50.000G	100NA	30V	50	.001A	
2N759A	N	S	TII, NSC, SOL, SSD, TEC, HUG	211	TO 18	60	60	8.0	.100A	.500W	200J	50.000G	100NA	30V	50	.001A	
2N759B	N	S	SOL, HUG	210	TO 18	60	60	8.0		.500W	200J	50.000G	100NA	30V	100		
2N760	N	S	AEI, AMC, GEC, NSC, TII, RAY	211	TO 18	45	45	8.0		.500W	200J	50.000G	100NA	30V	150		
2N760A	N	S	AMC, TII, RAY, ITT, NSC, SOL	210	TO 18	60	60	8.0		.500W	200J	50.000G	5NA	45V	150		
2N760B	N	S	SSD, SOL, HUG	210	TO 5	50	30	6.0	.100A	.500W	200J	5.000B	200NA	50V	400		
2N761	N	S	NSC	210	TO 5	50	30	6.0	.100A	.500W	200J	5.000B	200NA	50V	400		
2N762	N	S	NSC	210	TO 5	50	30	6.0	.100A	.500W	200J	5.000B	3UA	5V	40		
2N768	P	G	SPR, HUG	210	TO 18	12	7	2.0		.100A	.035W	100J	500.000G	3UA	5V	50	
2N769	P	G	SPR, HUG	210	TO 18	12	7	2.0		.100A	.035W	100J	500.000G	3UA	5V	120	
2N779A	N	S	SPR, MOT, HUG	210	TO 18	15	15S	2.0	.100A	.060W	100J	320.000G	10NA	40V	70		
2N780	N	S	AMC, TII, ETC	211	TO 18	45	45	5.0		.300W	175J	60.000G	3UA	5V	50		
2N781	-P	G	SYL	211	TO 18	15	15	2.5		.150W	100J	HS SW	3UA	5V	40		
2N782	-P	G	SYL	211	TO 18	40	20R	5.0	.200A	.300W	175J	200.000G	250NA	25V	40	.010A	
2N783	N	S	ITT, ETC, RAY	211	TO 18	30	15R	5.0	.200A	.300W	175J	200.000G	250NA	25V	50	.010A	
2N784	N	S	RAY, ITT, ETC, FSC, HUG	211	TO 18	40	15R	5.0	.200A	.360W	200J	300.000G	25NA	25V	70	.010A	
2N784A	N	S	RAY, ETC	211	TO 46	40	15	5.0	.200A	.360W	200J	200.000G	25NA	25V	70		
2N784A/46	N	S	SYL	211	TO 46	40	15	5.0	.200A	.360W	200J	200.000G	25NA	25V	70		
2N784A/51	N	S	SYL	910	TO 51	40	15	5.0	.200A	.360W	200J	200.000G	25NA	25V	70		
2N794	P	G	SPR, HUG	210	TO 18	13	12	4.0	.100A	.120W	100J	25.000G	3UA	6V	60	.010A	
2N795	P	G	SPR, HUG	210	TO 18	13	12	4.0	.100A	.120W	100J	35.000G	3UA	6V	100		
2N796	P	G	SPR, HUG	210	TO 18	13	12	4.0	.100A	.120W	100J	25.000G	1UA	10V	80		
2N797	N	G	TII	211	TO 18	20	4	12.0	.100A	.075W	85J	4.000B	5UA	12V	40		
2N799	-P	G	RAY	295	295A	35	12.0		.100A	.075W	85J	4.000B	5UA	12V	40		
2N800	-P	G	RAY	315	315A	25	12.0		.100A	.075W	85J	3.000B	25U	30V	20		
2N801	-P	G	RAY	295	295A	30	18	20.0	.400A	.075W	85J	5.000B	25U	40V	20		
2N802	-P	G	RAY	315	315A	30	18	20.0	.400A	.075W	85J	5.000B	25U	30V	22		
2N803	-P	G	RAY	295	295A	30	15	20.0	.400A	.075W	85J	5.000B	25U	30V	24		
2N804	-P	G	RAY	295	295A												

Transistor Type No.	N P	G S	Manufacturer	Lead Ident	Out- line	Maximum (V)			Maximum		Max. T.(°C)	Frequency Resp.(MHz)	Leakage I _{BR} @ V _{BR}	Gain h _{FE} @ I _C
						V _{CE}	V _{ES}	V _{BE}	I _C	Power				
2N827	P	C	MOT	210	TO 18	20	10X	4.0	.100A	-.150W	100J	250.000G	5UA 15V	150 .010A
2N828	P	C	MOT	211	TO 18	15	6	2.5	.200A	-.150W	100J	300.000G	3UA 6V	40 .010A
2N828A	P	P	MOT	211	TO 18	15	6	2.5	.200A	-.150W	100J	300.000G	3UA 6V	38 .150A
2N829	P	P	MOT	211	TO 18	15	6	2.5	.200A	-.150W	100J	300.000G	3UA 6V	38 .150A
2N834	N	S	AEI,ITT,RCA,SES,MOT,GIC	211	TO 18	40	30	5.0	.200A	-.150W	100J	300.000G	3UA 6V	75 .150A
2N834A	N	S	ITT,RAY,GIC,FSC	211	TO 18	40	30S	5.0	.200A	-.360W	200J	350.000G	5UA 20V	40 .010A
2N835	N	S	ITT,MOT,GIC,RAY,TEC,HUG	211	TO 18	25	20	3.0	.200A	-.300W	175J	300.000G	50QNA 20V	37 .010A
2N837	N	P	HUG	210	TO 18	12	6	1.0	.100A	-.150W	150C	300.000G	3UA 6V	40 .010A
2N838	P	C	MOT	210	TO 18	12	6	1.0	.100A	-.150W	150C	300.000G	3UA 6V	45 .010A
2N839	N	S	ETC,TEC,HUG	210	TO 18	45	45	2.0	.300W	175J	450.000G	10UA 15V	70 .010A	
2N840	N	S	ETC,TEC,MOT,HUG	210	TO 18	45	45	2.0	.300W	175J	30.000G	1UA 45V	27 .010A	
2N841	N	S	ETC,TEC,HUG	210	TO 18	45	45	2.0	.300W	175J	40.000G	1UA 45V	27 .010A	
2N842	N	S	ETC,TEC,HUG	210	TO 18	45	45	2.0	.300W	175J	40.000G	1UA 45V	27 .010A	
2N843	N	S	ETC,TEC,HUG	210	TO 18	45	45	2.0	.300W	175J	40.000G	1UA 45V	27 .010A	
2N844	N	S	ETC,TEC,HUG	210	TO 18	45	45	2.0	.300W	175J	40.000G	1UA 45V	27 .010A	
2N844A	N	S	SPR,HUG	210	TO 18	15	15S	2.0	.100A	-.060W	200J	320.000G	3UA 5V	60 .010A
2N849	N	S	TI	910	TO 50	20	12	5.0	.200A	-.300W	175J	200.000G	50QNA 75V	40 .010A
2N850	N	S	TI	910	TO 50	25	15	5.0	.050A	-.300W	175J	200.000G	50QNA 15V	80 .010A
2N851	N	S	TI	910	TO 50	25	15	5.0	.050A	-.300W	175J	200.000G	50QNA 15V	80 .010A
2N852	N	S	TI	910	TO 50	20	12	5.0	.200A	-.300W	175J	280.000G	1UA 20V	40 .010A
2N858	P	S	SPR,HUG	210	TO 18	40	40	25.0	.050A	-.150W	140J	5.000G	100NA 15V	26 .005A
2N859	P	S	SPR,HUG	210	TO 18	40	40	25.0	.050A	-.150W	140J	5.000G	100NA 15V	26 .005A
2N860	P	S	SPR,HUG	210	TO 18	25	25	20.0	.050A	-.150W	140J	6.500G	100NA 10V	20 .005A
2N861	P	S	SPR,HUG	210	TO 18	25	25	20.0	.050A	-.150W	140J	7.500G	100NA 10V	36 .005A
2N862	P	S	SPR,HUG	210	TO 18	15	15	10.0	.050A	-.150W	140J	8.000G	100NA 10V	24 .005A
2N863	P	S	SPR,HUG	210	TO 18	15	15	10.0	.050A	-.150W	140J	10.000G	100NA 10V	60 .005A
2N864	P	S	SPR,HUG	210	TO 18	6	6	6.0	.050A	-.150W	140J	16.000G	100NA 10V	84 .005A
2N865	P	S	SPR,HUG	210	TO 18	15	15	10.0	.050A	-.150W	140J	24.000G	100NA 10V	84 .005A
2N869	P	S	MOT,GIC,TEC,HUG	210	TO 18	25	18	5.0	.360W	200J	150.000G	10NA 15V	40 .030A	
2N869A	P	S	RAY,FSC,MOT,HUG	211	TO 18	100	60	7.0	.500W	200J	60.000G	10NA 75V	20 .150A	
2N870	N	S	AMC,TII,TRW,GEC,SES,ETC	211	TO 18	25	60	7.0	.360W	200J	400.000G	10NA 30V	80 .030A	
2N871	N	S	AMC,RAY,TII,TRW,GEC,SES	211	TO 18	100	60	7.0	.500W	200J	60.000G	10NA 75V	20 .150A	
2N872	N	S	TRW,TEC,FSC,HUG	211	TO 18	100	60	7.0	.500W	200J	60.000G	10NA 75V	20 .150A	
2N873	N	S	AMC,GEC,RAY,TII,TRW,TEC	211	TO 18	100	60	7.0	.500W	200J	60.000G	25NA 75V	130 .010A	
2N874	N	S	AMC,GEC,RAY,TII,TRW,TEC	211	TO 18	100	60	7.0	.500W	200J	50.000G	25NA 75V	130 .010A	
2N875	N	S	AEI,MOT,GEC,ITT,TII,GIC	211	TO 18	40	15	5.0	.360W	200J	300.000G	25NA 75V	30 .010A	
2N875A	N	S	AEI,MOT,GEC,ITT,TII,GIC	211	TO 18	40	15	5.0	.360W	200J	300.000G	25NA 75V	30 .010A	
2N876	N	S	AEI,MOT,GEC,ITT,TII,GIC	211	TO 18	40	15	5.0	.360W	200J	300.000G	25NA 75V	30 .010A	
2N877	N	S	AEI,MOT,GEC,ITT,TII,GIC	211	TO 18	40	15	5.0	.360W	200J	300.000G	25NA 75V	30 .010A	
2N878	N	S	AEI,MOT,GEC,ITT,TII,GIC	211	TO 18	40	15	5.0	.360W	200J	300.000G	25NA 75V	30 .010A	
2N879	N	S	AEI,MOT,GEC,ITT,TII,GIC	211	TO 18	40	15	5.0	.360W	200J	300.000G	25NA 75V	30 .010A	
2N880	N	S	AEI,MOT,GEC,ITT,TII,GIC	211	TO 18	40	15	5.0	.360W	200J	300.000G	25NA 75V	30 .010A	
2N881	N	S	AEI,MOT,GEC,ITT,TII,GIC	211	TO 18	40	15	5.0	.360W	200J	300.000G	25NA 75V	30 .010A	
2N882	N	S	AEI,MOT,GEC,ITT,TII,GIC	211	TO 18	40	15	5.0	.360W	200J	300.000G	25NA 75V	30 .010A	
2N883	N	S	AEI,MOT,GEC,ITT,TII,GIC	211	TO 18	40	15	5.0	.360W	200J	300.000G	25NA 75V	30 .010A	
2N884	N	S	AEI,MOT,GEC,ITT,TII,GIC	211	TO 18	40	15	5.0	.360W	200J	300.000G	25NA 75V	30 .010A	
2N885	N	S	AEI,MOT,GEC,ITT,TII,GIC	211	TO 18	40	15	5.0	.360W	200J	300.000G	25NA 75V	30 .010A	
2N886	N	S	AEI,MOT,GEC,ITT,TII,GIC	211	TO 18	40	15	5.0	.360W	200J	300.000G	25NA 75V	30 .010A	
2N887	N	S	AEI,MOT,GEC,ITT,TII,GIC	211	TO 18	40	15	5.0	.360W	200J	300.000G	25NA 75V	30 .010A	
2N888	N	S	AEI,MOT,GEC,ITT,TII,GIC	211	TO 18	40	15	5.0	.360W	200J	300.000G	25NA 75V	30 .010A	
2N889	N	S	AEI,MOT,GEC,ITT,TII,GIC	211	TO 18	40	15	5.0	.360W	200J	300.000G	25NA 75V	30 .010A	
2N890	N	S	AEI,MOT,GEC,ITT,TII,GIC	211	TO 18	40	15	5.0	.360W	200J	300.000G	25NA 75V	30 .010A	
2N891	N	S	AEI,MOT,GEC,ITT,TII,GIC	211	TO 18	40	15	5.0	.360W	200J	300.000G	25NA 75V	30 .010A	
2N892	N	S	AEI,MOT,GEC,ITT,TII,GIC	211	TO 18	40	15	5.0	.360W	200J	300.000G	25NA 75V	30 .010A	
2N893	N	S	AEI,MOT,GEC,ITT,TII,GIC	211	TO 18	40	15	5.0	.360W	200J	300.000G	25NA 75V	30 .010A	
2N894	N	S	AEI,MOT,GEC,ITT,TII,GIC	211	TO 18	40	15	5.0	.360W	200J	300.000G	25NA 75V	30 .010A	
2N895	N	S	AEI,MOT,GEC,ITT,TII,GIC	211	TO 18	40	15	5.0	.360W	200J	300.000G	25NA 75V	30 .010A	
2N896	N	S	AEI,MOT,GEC,ITT,TII,GIC	211	TO 18	40	15	5.0	.360W	200J	300.000G	25NA 75V	30 .010A	
2N897	N	S	AEI,MOT,GEC,ITT,TII,GIC	211	TO 18	40	15	5.0	.360W	200J	300.000G	25NA 75V	30 .010A	
2N898	N	S	AEI,MOT,GEC,ITT,TII,GIC	211	TO 18	40	15	5.0	.360W	200J	300.000G	25NA 75V	30 .010A	
2N899	N	S	AEI,MOT,GEC,ITT,TII,GIC	211	TO 18	40	15	5.0	.360W	200J	300.000G	25NA 75V	30 .010A	
2N900	N	S	AEI,MOT,GEC,ITT,TII,GIC	211	TO 18	40	15	5.0	.360W	200J	300.000G	25NA 75V	30 .010A	
2N901	N	S	AEI,MOT,GEC,ITT,TII,GIC	211	TO 18	40	15	5.0	.360W	200J	300.000G	25NA 75V	30 .010A	
2N902	N	S	AEI,MOT,GEC,ITT,TII,GIC	211	TO 18	40	15	5.0	.360W	200J	300.000G	25NA 75V	30 .010A	
2N903	N	S	AEI,MOT,GEC,ITT,TII,GIC	211	TO 18	40	15	5.0	.360W	200J	300.000G	25NA 75V	30 .010A	
2N904	N	S	AEI,MOT,GEC,ITT,TII,GIC	211	TO 18	40	15	5.0	.360W	200J	300.000G	25NA 75V	30 .010A	
2N905	N	S	AEI,MOT,GEC,ITT,TII,GIC	211	TO 18	40	15	5.0	.360W	200J	300.000G	25NA 75V	30 .010A	
2N906	N	S	AEI,MOT,GEC,ITT,TII,GIC	211	TO 18	40	15	5.0	.360W	200J	300.000G	25NA 75V	30 .010A	
2N907	N	S	AEI,MOT,GEC,ITT,TII,GIC	211	TO 18	40	15	5.0	.360W	200J	300.000G	25NA 75V	30 .010A	
2N908	N	S	AEI,MOT,GEC,ITT,TII,GIC	211	TO 18	40	15	5.0	.360W	200J	300.000G	25NA 75V	30 .010A	
2N909	N	S	AEI,MOT,GEC,ITT,TII,GIC	211	TO 18	40	15	5.0	.360W	200J	300.000G	25NA 75V	30 .010A	
2N910	N	S	AEI,MOT,GEC,ITT,TII,GIC	211	TO 18	40	15	5.0	.360W	200J	300.000G	25NA 75V	30 .010A	
2N911	N	S	AEI,MOT,GEC,ITT,TII,GIC	211	TO 18	40	15	5.0	.360W	200J	300.000G	25NA 75V	30 .010A	
2N912	N	S	AEI,MOT,GEC,ITT,TII,GIC	211	TO 18	40	15	5.0	.360W	200J	300.000G	25NA 75V	30 .010A	
2N913	N	S	AEI,MOT,GEC,ITT,TII,GIC	211	TO 18	40	15	5.0	.360W	200J	300.000G	25NA 75V	30 .010A	
2N914	N	S	AEI,MOT,GEC,ITT,TII,GIC	211	TO 18	40	15	5.0	.360W	200J	300.000G	25NA 75V	30 .010A	
2N914A	N	S	AEI,MOT,GEC,ITT,TII,GIC	211	TO 18	40	15	5.0	.360W	200J	300.000G	25NA 75V	30 .010A	
2N915	N	S	AEI,MOT,GEC,ITT,TII,GIC	211	TO 18	40	15	5.0	.360W	200J	300.000G	25NA 75V	30 .010A	
2N916	N	S	AEI,MOT,GEC,ITT,TII,GIC	211	TO 18	40	15	5.0	.360W	200J	300.000G	25NA 75V	30 .010A	
2N917	N	S	AEI,MOT,GEC,ITT,TII,GIC	211	TO 18	40	15	5.0	.360W	200J	300.000G	25NA 75V	30 .010A	
2N918	N	S	AEI,MOT,GEC,ITT,TII,GIC	211	TO 18	40	15	5.0	.360W	200J	300.000G	25NA 75V	30 .010A	
2N919	N	S	AEI,MOT,GEC,ITT,TII,GIC	211	TO 18	40	15	5.0	.360W	200J	300.000G	25NA 75V	30 .010A	
2N920	N	S	AEI,MOT,GEC,ITT,TII,GIC	211	TO 18	40	15	5.0	.360W	200J	300.000G	25NA 75V	30 .010A	
2N921	N	S	AEI,MOT,GEC,ITT,TII,GIC	211	TO 18	40	15	5.0	.360W	200J	300.000G	25NA 75V	30 .010A	
2N922	N	S	AEI,MOT,GEC,ITT,TII,GIC	211	TO 18	40	15	5.0	.360W	200J	300.000G	25NA 75V	30 .010A	
2N923	N	S	AEI,MOT,GEC,ITT,TII,GIC	211	TO 18	40	15	5.0	.360W	200J	300.000G	25NA 75V	30 .010A	
2N924	N	S	AEI,MOT,GEC,ITT,TII,GIC	211	TO 18	40	15	5.0	.360W	200J	300.000G	25NA 75V	30 .010A	
2N925	N	S	AEI,MOT,GEC,ITT,TII,GIC	211	TO 18	40	15	5.0	.360W	200J	300.000G	25NA 75V	30 .010A	
2N926	N	S	AEI,MOT,GEC,ITT,TII,GIC	211	TO 18	40	15	5.0	.360W	200J	300.000G	25NA 75V	30 .010	

Transistor Type No.	N P S	G S	Manufacturer	Lead Ident	Out. line	Maximum (V)			Maximum Power		Max. T.(C)	Frequency Resp.(MHz)	Leakage		Gain h _{FE} @ I _C	
						V _{CE}	V _{ES}	V _{ES}	I _C	Power			I _{CE0}	V _{CE0}		
2N1000	N	G	ETC	210	TO 5	40	30R	40.0	.200A	.150W	100J	7.000B	151A	40V	50	1.00A
2N1005	N	S	TI1	210	TO 5	15	15	5		.125W	150J	50.000G	1UA	10V	30	
2N1006	N	S	TI1	210	TO 5	15	15	.5		.125W	150J	50.000G	1UA	10V	80	
2N1007	N	P	G SYL	605	TO 3	40	35R		3.000A	25.000W	95J	.005E	2MA	15V	40	
2N1008	P	G	MOT, ETC	210	TO 5	20	15R	15.0		.300A	.165W	85J	.025E	100A	10V	80
2N1008A	P	G	ETC, MOT	210	TO 5	40	35R	15.0		.300A	.165W	85J	.025E	150A	25V	100
2N1008B	P	G	ETC, MOT	210	TO 5	60	10	10.0		.020A	.040W	85J	2.000B	100A	10V	35
2N1010	N	G	ETC	120	TO 1	10	10	10.0		.002A	.020W	55A	2.000B	100A	10V	36
2N1010+	N	G	ETC	605	TO 3	80	40	40.0		5.000A	60.000W	95A	3.000B	5UA	5V	80
2N1011	N	G	DEL, MOT, BEN, ETC, HUG	210	TO 5	40	22	5.0			.150W	85J	3.000B	5UA	5V	80
2N1012	N	G	ETC, GIC	605	TO 3	100	65	60.0		10.000A	50.000W	100J	.005E	500UA	30V	14
2N1014	N	P	G S	412	TO 82	30	30S	25.0		7.500A	175.000W	150J	.020E	20MA	30V	14
2N1015	N	S	AMF, STC, WHE, SPC, HUG	412	TO 82	60	60S	25.0		7.500A	175.000W	150J	.020E	20MA	60V	14
2N1015A	N	S	AMF, STC, WHE, SPC, HUG	412	TO 82	100	100S	25.0		7.500A	175.000W	150J	.020E	20MA	100V	14
2N1015B	N	S	AMF, STC, WHE, SPC, HUG	412	TO 82	150	150S	25.0		7.500A	175.000W	150J	.020E	20MA	150V	14
2N1015C	N	S	AMF, STC, WHE, SPC, HUG	412	TO 82	200	200	25.0		7.500A	150.000W	150J	.025E	20MA	200V	14
2N1015D	N	S	WHE, STC, SPC, HUG	412	TO 82	250	250	25.0		7.500A	150.000W	150J	.025E	20MA	250V	14
2N1015E	N	S	WHE, STC, SPC, HUG	412	TO 82	30	30	25.0		7.500A	150.000W	150J	.030E	20MA	30V	18
2N1016	N	S	WHE, STC, SPC, HUG	412	TO 82	100	100	25.0		7.500A	150.000W	150J	.030E	20MA	100V	18
2N1016A	N	S	WHE, STC, SPC, HUG	412	TO 82	150	150	25.0		7.500A	150.000W	150J	.030E	20MA	150V	18
2N1016B	N	S	WHE, STC, SPC, HUG	412	TO 82	200	200	25.0		7.500A	150.000W	150J	.030E	20MA	200V	18
2N1016C	N	S	WHE, STC, SPC, HUG	412	TO 82	250	250	25.0		7.500A	150.000W	150J	.030E	20MA	250V	18
2N1016D	N	S	WHE, STC, SPC, HUG	210	TO 5	20	10	20.0		4.00A	.150W	100J	20.000B	25UA	30V	40
2N1016E	N	S	WHE, STC, SPC, HUG	210	TO 5	30	8R	20.0			.150W	100J	15.000B	25UA	30V	30
2N1017	P	G	ETC	605	TO 3	100	50	20.0		5.000A	85.000W	100J	.200E	2MA	100V	36
2N1018	P	G	ETC	605	TO 3	100	50	20.0		5.000A	100.000W	100J	.200E	2MA	100V	36
2N1021	P	G	DEL, BEN, MOT, TI1, ETC, HUG	605	TO 3	100	50	20.0		5.000A	85.000W	100J	.200E	2MA	100V	36
2N1021A	P	G	DEL, TI1, BEN, ETC, HUG	605	TO 3	120	50	30.0		7.000A	100.000W	100J	.200E	2MA	120V	60
2N1022	P	G	DEL, TI1, BEN, ETC, HUG	605	TO 3	120	50	30.0		7.000A	100.000W	100J	.200E	2MA	120V	60
2N1023	P	G	RCA	128	TO 44	40		.5		.010A	.120W	100J	30.000B	12UA	12V	70
2N1024	P	S	SSD, NSC, SOL, HUG	210	TO 5	18	15	18.0		.100A	.250W	175J	1.000G	25NA	40V	15
2N1025	P	S	SSD, NSC, SOL, HUG	210	TO 5	40	35	40.0		.100A	.250W	175J	2.000G	25NA	40V	30
2N1026	P	S	SSD, NSC, SOL, HUG	210	TO 5	18	15	18.0		.100A	.250W	175J	4.000B	25NA	15V	36
2N1026A	P	S	SSD, NSC, SOL, HUG	210	TO 5	12	10	12.0		.100A	.250W	175J	2.000B	25NA	10V	26
2N1027	P	S	SSD, SOL, HUG	605	TO 41	60	30			15.000A	90.000W	100J	.004E	2MA	15V	40
2N1028	P	S	SSD, SOL, HUG	607	TO 41	60	30			15.000A	90.000W	100J	.004E	2MA	15V	40
2N1031	P	G	BEN, ETC, SOL, HUG	607	TO 41	60	30			15.000A	90.000W	100J	.004E	2MA	25V	40
2N1031A	P	G	BEN, ETC, SOL, HUG	607	TO 41	90	60			15.000A	90.000W	100J	.004E	2MA	60V	40
2N1031B	P	G	BEN, ETC, SOL, HUG	607	TO 41	100	70			15.000A	90.000W	100J	.004E	2MA	60V	40
2N1031C	P	G	BEN, ETC, SOL, HUG	607	TO 41	100	70			15.000A	90.000W	100J	.004E	2MA	60V	40
2N1032	P	G	BEN, ETC, SOL, HUG	607	TO 41	50	20			15.000A	90.000W	100J	.004E	2MA	50V	40
2N1032A	P	G	BEN, ETC, SOL, HUG	607	TO 41	90	60			15.000A	90.000W	100J	.004E	2MA	90V	40
2N1032B	P	G	BEN, ETC, SOL, HUG	607	TO 41	90	60			15.000A	90.000W	100J	.004E	2MA	90V	40
2N1032C	P	G	BEN, ETC, SOL, HUG	607	TO 41	100	70			15.000A	90.000W	100J	.004E	2MA	60V	40
2N1034	P	S	SSD, NSC, SOL	210	TO 5	50	40	20.0		.050A	.250W	160J	1.50B	1UA	30V	150
2N1035	P	S	SSD, NSC, SOL	210	TO 5	50	40	20.0		.050A	.250W	160J	3.00B	1UA	30V	150
2N1036	P	S	SSD, NSC, SOL	210	TO 5	50	35	20.0		.050A	.250W	160J	1.50B	1UA	30V	150
2N1037	P	S	SSD, SOL	210	TO 5	50	35	20.0		.050A	.250W	160J	1.50B	1UA	30V	150
2N1038	P	G	BEN, TI1, MOT, HUG	211	TO 5	40	30	20.0		3.000A	.400W	100J	.008E	125UA	20V	36
2N1038-1	P	G	BEN	541	541B	40	30	20.0		3.000A	.400W	100J	.008E	125UA	20V	36
2N1038-2	P	G	BEN	541	541A	40	30	20.0		3.000A	.400W	100J	.008E	125UA	20V	36
2N1039	P	G	BEN, TI1, MOT	211	TO 5	60	40	20.0		3.000A	.400W	100J	.008E	125UA	30V	36
2N1039-1	P	G	BEN	541	541B	60	40	20.0		3.000A	.400W	100J	.008E	125UA	30V	36
2N1039-2	P	G	BEN	541	541A	60	40	20.0		3.000A	.400W	100J	.008E	125UA	30V	36
2N1040	P	G	BEN, TI1, MOT	211	TO 5	80	50	20.0		3.000A	.400W	100J	.008E	125UA	40V	36
2N1040-1	P	G	BEN	541	541B	80	50	20.0		3.000A	.400W	100J	.008E	125UA	40V	36
2N1040-2	P	G	BEN	541	541A	80	50	20.0		3.000A	.400W	100J	.008E	125UA	40V	36
2N1041	P	G	BEN, TI1, MOT	211	TO 5	100	60	20.0		3.000A	.400W	100J	.008E	125UA	50V	36
2N1041-1	P	G	BEN	541	541B	100	60	20.0		3.000A	.400W	100J	.008E	125UA	50V	36
2N1041-2	P	G	BEN	541	541A	100	60	20.0		3.000A	.400W	100J	.008E	125UA	50V	36
2N1042	P	G	BEN, TI1, MOT	541	541A	40	30	20.0		3.000A	.2000W	100J	.250G	125UA	20V	36
2N1042-1	P	G	BEN	541	541B	40	30	20.0		3.000A	.2000W	100J	.008E	125UA	20V	36
2N1042-2	P	G	BEN	211	TO 5	40	30	20.0		3.000A	.400W	100J	.008E	125UA	20V	36
2N1043	P	G	BEN, TI1, MOT	541	541A	40	30	20.0		3.000A	.400W	100J	.008E	125UA	30V	36
2N1043-1	P	G	BEN	541	541B	60	40	20.0		3.000A	.2000W	100J	.008E	125UA	30V	36
2N1043-2	P	G	BEN	211	TO 5	60	40	20.0		3.000A	.400W	100J	.008E	125UA	30V	36
2N1044	P	G	BEN, TI1, MOT	541	541A	80	50	20.0		3.000A	.2000W	100J	.250G	125UA	40V	36
2N1044-1	P	G	BEN	541	541B	80	50	20.0		3.000A	.2000W	100J	.008E	125UA	40V	36
2N1044-2	P	G	BEN	211	TO 5	80	50	20.0		3.000A	.400W	100J	.008E	125UA	40V	36
2N1045	P	G	BEN, TI1, MOT	541	541A	100	60	20.0		3.000A	.2000W	100J	.250G	125UA	50V	36
2N1045-1	P	G	BEN	541	541B	100	60	20.0		3.000A	.2000W	100J	.008E	125UA	50V	36
2N1045-2	P	G	BEN	211	TO 5	100	60	20.0		3.000A	.400W	100J	.008E	125UA	50V	36
2N1046	P	G	TI1, ETC	605	TO 3	100	50	1.5		10.000A	30.000W	100J	.300E	10UA	130V	100
2N1046A	P	G	TI1, ETC	605	TO 3	130	50	1.5		10.000A	30.000W	100J	.300E	10UA	130V	100
2N1047	N	S	TI1, ETC	461	TO 57	80	80	6.0		40.000W	200J	.200E	150A	30V	24	
2N1047A	N	S	ETC, TI1	461	TO 57	80	80	10.0		40.000W	200J	.090E	250UA	80V	24	
2N1047B	N	S	TI1, ETC	461	TO 57	80	80	6.0		40.000W	200J	.125E	50UA	80V	24	
2N1048	N	S	ETC, TI1	461	TO 57	120	120	10.0		40.000W	200J	.200E	150A	30V	24	
2N1048A	N	S	ETC, TI1	461	TO 57	120	120	10.0		40.000W	200J	.090E	250UA	80V	24	
2N1048B	N	S	TI1, ETC	461	TO 57	120	120	6.0		40.000W	200J	.125E	50UA	80V	24	
2N1049	N	S	TI1, ETC	461	TO 57	80	80	6.0		40.000W	200J	.200E	150A	30V	24	
2N1049A	N	S	ETC, TI1	461	TO 57	80	80	6.0		40.000W	200J	.090E	250UA	80V	24	
2N1049B	N	S	ETC, TI1	461	TO 57	80	80	6.0		40.000W	200J	.125E	50UA	80V	24	
2N1050	N	S	TI1, ETC	461	TO 57	120	120	10.0		40.000W	200J	.200E	150A	30V	24	
2N1050A	N	S	ETC, TI1	461	TO											

Transistor Type No.	N P S	G T C	Manufacturer	Lead Ident	Out. line	Maximum (V)			Maximum		Max. T.(°C)	Frequency Resp.(MHz)	Leakage I _{BR} @ V _{BR}	Gain h _{FE} @ I _C		
						V _{CE}	V _{CE}	V _{CE}	I _C	Power						
2N1080	N	S	ETC,TEC,HUG	731	TO 53	60	60	10.0	3.000A	60.000W	200J	10.000G	3UA	5V	40	1.000A
2N1086+	N	G	ETC	210	TO 5	9	9		.020A	.065W	85J	5.000B	3UA	5V	120	
2N1086+	N	G	ETC	210	TO 12A	9	9		.020A	.065W	85J	8.000B	3UA	5V	40	
2N1086A+	N	G	ETC	210	TO 5	9	9		.020A	.065W	85A	5.000B	3UA	5V	120	
2N1087	N	G	ETC	210	TO 12A	9	9		.020A	.065W	85A	8.000B	3UA	5V	40	
2N1087+	N	G	ETC	210	TO 5	9	9		.020A	.065W	85A	5.000B	3UA	5V	120	
2N1090	N	G	ETC	210	TO 9	25	15	20.0	.400A	.120W	85J	5.000B	8UA	12V	50	
2N1090+	N	G	ETC	170	TO 9	25	15	20.0	.400A	.120W	85A	5.000B	8UA	12V	50	
2N1091	N	G	ETC	210	TO 5	18	18	5.0	.500A	.800W	175A	10.000B	8UA	12V	70	
2N1091+	N	G	ETC	170	TO 9	25	15	20.0	.400A	.120W	85J	10.000B	8UA	12V	70	
2N1092	N	G	AMF,ETC	210	TO 5	60	30	12.0	.500A	.800W	175A	10.000B	8UA	12V	70	
2N1093	P	G	ETC	210	TO 5	30	15.0		.250A	.150W	100J	5.000B	6UA	30V	130	
2N1097	P	G	ETC	212	TO 5	18	18	5.0	.200A	.200W	85A	1.000B	16UA	16V	60	
2N1098	P	G	ETC,ETC	212	TO 5	18	18	5.0	.200A	.200W	85A	1.000B	16UA	16V	60	
2N1099	P	G	DEL,MOT,ETC,SOL,HUG	405	TO 36	80	60	40.0	15.000A	150.000W	100A	0.10E	4MA	80V	50	5.000A
2N1100	P	G	MOT,ETC,DEL,SOL,HUG	405	TO 36	100	65	80.0	15.000A	150.000W	100C	0.10E	4MA	100V	50	5.000A
2N1101+	N	G	ETC	210	TO 5	20	15R	10.0	.100A	.180W	75J	0.10B	20UA	20V	44	.035A
2N1102	N	G	ETC	210	TO 5	40	25	10.0	.100A	.180W	85J	0.10B	20UA	20V	44	
2N1102+	N	G	ETC	10	TO 22	40	25	10.0	.100A	.180W	85J	0.10B	50UA	40V	44	.035A
2N1107	P	G	ETC	210	TO 5	16	10.0		.005A	.030W	85J	25.000B	10UA	12V	44	
2N1108	P	G	ETC	210	TO 5	16	10.0		.005A	.030W	85J	20.000B	10UA	12V	44	
2N1108+	P	G	ETC	210	TO 22	16	10.0		.005A	.030W	85J	25.000B	10UA	12V	32	
2N1109	P	G	ETC	210	TO 5	16	10.0		.005A	.030W	85J	30.000B	10UA	12V	20	
2N1109+	P	G	ETC	10	TO 22	16	10.0		.005A	.030W	85J	30.000B	10UA	12V	20	
2N1110	P	G	ETC	210	TO 5	16	10.0		.005A	.030W	85J	20.000B	10UA	12V	30	
2N1110+	P	G	ETC	10	TO 22	16	10.0		.005A	.030W	85J	35.000B	10UA	12V	30	
2N1114	P	G	ETC	212	TO 5	25	15	10.0	.200A	.150W	100J	20.000B	10UA	12V	30	
2N1115	P	G	ETC	210	TO 5	20	15	10.0	.125A	.150W	85J	5.000B	6UA	20V	70	
2N1116	N	S	ETC,TEC,HUG	210	TO 5	60	60	6.0	.800A	.600W	200J	6.000G	15UA	60V	90	
2N1117	N	S	SSP,TEC,HUG	60	TO 5	60	60	6.0	.800A	.600W	200J	4.000G	15UA	60V	100	
2N1118	N	S	SPR,SOL,HUG	210	TO 5	25	25	10.0	.050A	.150W	140J	100NA	25V	24	.001A	
2N1118A	P	S	SOL,SPR,HUG	210	TO 5	25	25	10.0	.050A	.150W	140J	8.000F	1UA	25V	20	.001A
2N1119	P	S	SPR,SOL,HUG	210	TO 5	10	10	10.0	.050A	.150W	140J	7.200G	100NA	10V	24	.015A
2N1120	P	G	MOT,BEN,ETC,HUG	60	TO 41	80	40	40.0	15.000A	90.000W	100J	0.03E	15MA	80V	32	10.000A
2N1121+	N	G	ETC	116	TO 12A	15	15		.020A	.065W	85A	8.000B	5UA	15V	60	
2N1121	N	G	ETC	210	TO 5	15	15R	5.0	.020A	.065W	85A	5.000B	5UA	15V	60	
2N1122	P	G	SPR	116	TO 24	12	11S		.050A	.025W	100J	40.000G	5UA	6V	50	
2N1122A	P	G	SPR	116	TO 24	15	14S		.050A	.025W	100J	40.000G	5UA	6V	50	
2N1123	P	G	PHL	171	TO 31	45	40S	45.0	.500A	.750W	100J	3.000B	25UA	45V	70	
2N1124+	P	G	PHL	105	TO 25	40	40		1.50A	3.00W	85J	4.00B	75UA	40V	80	
2N1124	P	G	ETC	210	TO 5	40	35R	40.0	.250A	.300W	85J	4.00B	75UA	40V	100	
2N1125	P	G	PHL	210	TO 5	40	40R	40.0	.150A	.300W	85J	1.000B	75UA	40V	100	
2N1125+	P	G	PHL	172	TO 172A	40	40		.150A	.300W	85J	1.000B	75UA	40V	100	
2N1126	P	G	PHL	172	TO 172A	40	40		.150A	.300W	85J	1.000B	75UA	40V	100	
2N1127	P	G	PHL	172	TO 172A	40	40		.150A	.300W	85J	1.000B	75UA	40V	100	
2N1128	P	G	ETC	210	TO 5	25	18R	5.0	.250A	.150W	85J	1.000B	15UA	25V	90	
2N1128+	P	G	PHL	105	TO 25	25	25		.150A	.150W	85J	1.000B	20UA	10V	100	
2N1129	P	G	ETC	210	TO 5	25	25R	5.0	.250A	.150W	85J	5.00B	15UA	25V	160	
2N1130	P	G	PHL	105	TO 25	25	25		.150A	.150W	85J	7.50B	15UA	25V	160	
2N1130+	P	G	PHL	105	TO 25	25	30R	5.0	.250A	.150W	85J	7.00B	15UA	25V	100	
2N1131	P	S	TIJ,MOT,SES,RAY,GIC,TEC	105	TO 25	25	35	5.0	.150A	.150W	85J	7.50B	25UA	30V	110	
2N1131/51	P	S	TIJ	909	TO 5	50	35	5.0	.600A	.600W	175J	50.000G	1UA	30V	30	.150A
2N1131A	P	S	HUG,TEC	211	TO 5	60	40	5.0	.600A	.600W	175J	50.000G	1UA	30V	30	
2N1131A/51	P	S	TIJ	909	TO 51	60	40	5.0	.600A	.600W	175J	50.000G	500NA	45V	30	.150A
2N1132	P	S	HUG,RAY,SES,ETC,TIJ,MOT	211	TO 5	50	35	5.0	.600A	.600W	175J	50.000G	500NA	45V	30	.150A
2N1132/51	P	S	TIJ	211	TO 5	50	35	5.0	.600A	.600W	175J	60.000G	100NA	50V	48	.150A
2N1132A	P	S	HUG,MOT,ITT,TEC,FSC	211	TO 5	60	40	5.0	.600A	.600W	175J	60.000G	1UA	30V	60	
2N1132A/51	P	S	TIJ	909	TO 51	60	40	5.0	.600A	.600W	175J	60.000G	500NA	45V	60	.150A
2N1132B/51	P	S	TIJ	211	TO 5	70	45	6.0	.600A	.600W	175J	60.000G	10NA	50V	60	
2N1136	P	G	BEN,ETC,HUG	605	TO 3	60	30	15.0	.600A	.600W	175J	60.000G	10NA	50V	75	
2N1136A	P	G	BEN,ETC,HUG	605	TO 3	90	55	15.0	6.000A	94.000W	100J	0.04E	1MA	25V	60	3.000A
2N1136B	P	G	BEN,ETC,HUG	605	TO 3	100	65	15.0	6.000A	94.000W	100J	0.04E	1MA	25V	75	3.000A
2N1137	P	G	BEN,ETC,HUG	605	TO 3	60	30	15.0	6.000A	94.000W	100J	0.04E	1MA	25V	112	3.000A
2N1137A	P	G	BEN,ETC,HUG	605	TO 3	100	65	15.0	6.000A	94.000W	100J	0.04E	1MA	25V	112	3.000A
2N1137B	P	G	BEN,ETC,HUG	605	TO 3	100	65	15.0	6.000A	94.000W	100J	0.04E	1MA	60V	112	3.000A
2N1138	P	G	BEN,ETC,HUG	605	TO 3	60	30	15.0	5.000A	90.000W	100J	0.04E	1MA	60V	112	3.000A
2N1138A	P	G	BEN,ETC,HUG	605	TO 3	100	65	15.0	6.000A	94.000W	100J	0.04E	200UA	2V	150	3.000A
2N1138B	P	G	BEN,ETC,HUG	605	TO 3	90	55	15.0	5.000A	90.000W	100J	0.04E	200UA	2V	150	3.000A
2N1139	N	S	TEC,ETC	211	TO 5	15	15	3.0	5.000A	90.000W	100J	0.04E	200UA	2V	150	3.000A
2N1140	N	S	ETC	210	TO 5	40	40	5.0	.500W	.175J	100	100.000G	5UA	15V	40	.010A
2N1141	N	S	TIJ,MOT	211	TO 5	35	1.0		.100A	.300W	100J	35.000G	15UA	40V	30	.050A
2N1142	N	S	TIJ,MOT	211	TO 5	30			.100A	.300W	100J	600.000B	5UA	15V	40	
2N1143	P	G	ETC	210	TO 5	25	15		.100A	.300W	100J	480.000B	5UA	15V	40	
2N1144	P	G	ETC	210	TO 5	16R			.100A	.140W	60J	1.000B	16UA	16V	60	
2N1144+	P	G	SSP,GEC	57	57B	16R	5.0		1.00A	.140W	60J	1.000B	16UA	16V	60	
2N1145	P	G	ETC	210	TO 5	16R			.100A	.140W	60J	1.000B	16UA	16V	60	
2N1146	P	G	BEN,ETC,SOL,HUG	57	57B	16R	5.0		1.00A	.140W	60J	1.000B	16UA	16V	56	
2N1146A	P	G	BEN,ETC,SOL,HUG	605	TO 3	60	30	30.0	15.000A	94.000W	100J	0.02E	20MA	40V	100	5.000A
2N1146B	P	G	BEN,ETC,SOL,HUG	605	TO 3	80	40	30.0	15.000A	94.000W	100J	0.02E	20MA	60V	100	5.000A
2N1146C	P	G	BEN,ETC,SOL,HUG	605	TO 3	100	50	30.0	15.000A	94.000W	100J	0.02E	20MA	80V	100	5.000A
2N1147	P	G	BEN,ETC,SOL,HUG	607	TO 41	40	20	30.0	15.000A	94.000W	100J	0.02E	20MA	100V	100	5.000A
2N1147A	P	G	BEN,ETC,SOL,HUG	607	TO 41	80	40	30.0	15.000A	94.000W	100J	0.02E	40MA	40V	100	5.000A
2N1147B	P	G	BEN,ETC,SOL,HUG	607	TO 41	80	40	30.0	15.000A	94.000W	100J	0.02E	40MA	60V	100	5.000A
2N1147C	P	G	BEN,ETC,SOL,HUG	607	TO 41	100	50	30.0	15.000A	94.000W	100J	0.02E	40MA	100V	100	5.000A
2N1149	N	S	TIJ,ETC,HUG	10	TO 22	45	1.0		.025A	.150W	175J	12.000B	2UA	30V	16	
2N1150	N	S	TIJ,ETC,HUG	10	TO 22	45										

Transistor Type No.	N P S	Manufacturer	Lead Ident	Out- line	Maximum (V)			Maximum		Max. T.(°C)	Frequency Resp.(MHz)	Leakage I _{BO} @ V _{CE}	Gain h _{FE} @ I _C		
					V _{BE}	V _{CE}	V _{CE(sat)}	I _C	Power						
2N1164A	P	MOT,BEN,ETC,SOL,HUG	605	To 3	80	60S	40.0	25.000A	90.000W	100J	.004E	15MA	80V	50	25.000A
2N1165	P	MOT,BEN,ETC,SOL,HUG	607	To 41	80	60S	40.0	25.000A	90.000W	100J	.004E	225UA	2V	40	25.000A
2N1165A	P	MOT,BEN,ETC,SOL,HUG	607	To 41	50	35S	40.0	25.000A	90.000W	100J	.004E	225UA	2V	40	25.000A
2N1166	P	MOT,BEN,ETC,SOL,HUG	605	To 3	100	75S	50.0	25.000A	90.000W	100J	.004E	15MA	100V	50	25.000A
2N1166A	P	MOT,BEN,ETC,SOL,HUG	605	To 3	100	75S	50.0	25.000A	90.000W	100J	.004E	225UA	2V	40	25.000A
2N1167	P	MOT,BEN,ETC,SOL,HUG	607	To 41	100	75S	50.0	25.000A	90.000W	100J	.004E	15MA	100V	50	25.000A
2N1167A	P	MOT,BEN,ETC,SOL,HUG	607	To 41	100	75S	50.0	25.000A	90.000W	100J	.004E	15MA	100V	50	25.000A
2N1168	P	MOT,BEN,ETC,DEL,HUG	605	To 3	50	30R	20.0	5.000A	90.000W	100J	.004E	8MA	50V	64	5.000A
2N1169	N	GEN,ETC	229	To 5	20	18	20.0	.400A	.120W	85J	4.500B	10UA	12V	40	.001A
2N1171	-P	GEN,ETC	210	To 5	30	12	20.0	.400A	.150W	85J	10.000B	5UA	12V	60	.001A
2N1172	-P	DEL	631	To 37	40	16	20.0	1.500A	7.500W	100J	.017E	2MA	40V	60	
2N1175	-P	GEN,ETC	212	To 5	35	25R	10.0	.200A	.200W	85J	1.500B	12MA	12V	90	
2N1175A	-P	GEN,ETC	212	To 5	35	25R	10.0	.200A	.200W	85J	1.500B	12UA	30V	90	.020A
2N1176	-P	GEN,ETC	210	To 5	40	40R	10.0	.300A	.200W	100J	.015E	25UA	10V	30	
2N1176A	-P	GEN,ETC	210	To 5	40	40R	10.0	.300A	.200W	100J	.015E	30UA	25V	30	
2N1176B	-P	GEN,ETC	210	To 5	60	60R	10.0	.300A	.200W	100J	.015E	35UA	45V	30	
2N1177	-P	RCRA	75	To 45	30	1.0	1.0	.010A	.080W	71A	140.004B	12UA	12V	40	
2N1178	-P	RCRA	75	To 45	30	1.0	1.0	.010A	.080W	71A	140.000B	12UA	12V	80	.001A
2N1179	-P	RCRA	75	To 45	30	1.0	1.0	.010A	.080W	70J	100.000G	12UA	12V	150	
2N1180	-P	RCRA	171	To 8	45	20	20.0	3.000A	1.000W	100J	.504B	250UA	60V	32	
2N1183	-P	RCRA	171	To 8	60	30	20.0	3.000A	1.000W	100J	.504B	250UA	80V	32	
2N1183A	-P	RCRA	171	To 8	45	20	20.0	3.000A	1.000W	100J	.504B	250UA	45V	80	
2N1184	-P	RCRA	171	To 8	60	30	20.0	3.000A	1.000W	100J	.504B	250UA	60V	80	
2N1184A	-P	RCRA	171	To 8	45	20	20.0	3.000A	1.000W	100J	.504B	250UA	45V	80	
2N1184B	-P	RCRA	171	To 8	60	30	20.0	3.000A	1.000W	100J	.504B	250UA	60V	80	
2N1185	-P	ETC,MOT	210	To 5	45	40R	10.0	.400A	.200W	100J	1.750B	10UA	30V	170	.010A
2N1186	-P	ETC,MOT	210	To 5	60	45R	30.0	.500A	.200W	100J	1.000B	10UA	45V	44	.010A
2N1187	-P	ETC,MOT	210	To 5	60	45R	30.0	.500A	.200W	100J	1.250B	10UA	45V	75	.010A
2N1188	-P	ETC,MOT	210	To 5	45	30R	15.0	.500A	.200W	100J	2.500B	10UA	25V	145	.010A
2N1189	-P	MOT	210	To 5	45	30R	15.0	.500A	.200W	100J	2.250B	50UA	45V	136	.010A
2N1190	-P	ETC,MOT	210	To 5	40	25R	25.0	.200A	.200W	85J	1.500B	15UA	25V	40	.010A
2N1192	-P	ETC,MOT	210	To 5	40	25R	25.0	.200A	.200W	85J	2.000B	15UA	25V	74	.010A
2N1193	-P	ETC,MOT	210	To 5	40	25R	25.0	.200A	.200W	85J	2.500B	15UA	25V	145	.010A
2N1194	-P	ETC,MOT	210	To 5	25	25R	25.0	.200A	.200W	85J	1.000B	15UA	25V	275	.010A
2N1195	-P	ETC,MOT	210	To 5	30	1.0	1.0	.040A	.225W	100J	1000.000B	5UA	20V	25	.010A
2N1195	-P	ETC	210	To 5	25	25	2.0	.075A	.075W	85J	5.000B	2UA	15V	60	
2N1199	N	S,ETC	211	To 10	20	15	3.0	.100A	.300W	150J	75.000G	700UA	10V	27	.020A
2N1202	P	SOL,HUG	427	To 10	80	60	20.0	3.500A	34.000W	100J	.200G	2MA	120V	44	2.000A
2N1203	P	SOL,HUG	210	To 5	120	70	28.0	3.500A	34.000W	100J	.200G	2MA	120V	44	2.000A
2N1204	P	SOL,HUG	210	To 5	20	15	4.0	.500A	.300W	100J	110.000G	7UA	5V	35	.400A
2N1204A	P	GMOT	210	To 5	20	15	4.0	.500A	.300W	100J	110.000G	7UA	5V	50	.200A
2N1206	N	ETC,TEC,HUG	210	To 5	60	60	3.0	1.000W	1.000W	200J	10.000G	10UA	30V	30	.050A
2N1207	N	ETC,TEC,HUG	210	To 5	125	125	3.0	5.000A	85.000W	200J	12.000B	10MA	60V	30	2.000A
2N1208	N	BEN,TEC,SES,ETC,HUG	561	To 61	45	45	5.0	5.000A	85.000W	200J	12.000B	20MA	45V	40	2.000A
2N1209	N	BEN,TEC,SES,ETC,HUG	731	To 53	60	60	8.0	5.000A	30.000W	200J	15.000B	1MA	60V	35	2.000A
2N1210	N	BEN,TEC,ETC,HUG	731	To 53	60	60	8.0	5.000A	30.000W	200J	15.000B	1MA	60V	35	1.000A
2N1211	N	BEN,TEC,ETC,HUG	731	To 53	60	60	8.0	5.000A	30.000W	200J	10.000B	10MA	60V	22	1.000A
2N1212	N	BEN,TEC,ETC,HUG	731	To 61	60	60	10.0	5.000A	85.000W	200J	6.000B	2UA	15V	68	
2N1217	N	GEN,ETC	12	To 12A	20	20	5.0	.025A	.075W	85J	6.000B	1UA	13V	60	
2N1217+	N	GEN,ETC	605	To 3	45	45	20.0	2.000A	6.000W	85J	.007E	3MA	45V	10	.005A
2N1218	-P	S,SSD,NSC,SOL,HUG	210	To 5	30	25	10.0	.100A	.250W	175J	2.000B	100UA	10V	14	.005A
2N1219	-P	S,SSD,NSC,SOL,HUG	210	To 5	30	25	10.0	.100A	.250W	175J	2.000B	100UA	10V	14	.005A
2N1220	-P	S,SSD,NSC,SOL,HUG	210	To 5	30	25	10.0	.100A	.250W	175J	5.000B	100UA	10V	27	.001A
2N1221	-P	S,SSD,NSC,SOL,HUG	210	To 5	30	25	10.0	.100A	.250W	175J	2.000B	100UA	10V	14	.001A
2N1222	-P	S,SSD,NSC,SOL,HUG	210	To 5	40	25	10.0	.100A	.250W	175J	2.000B	100UA	10V	10	.001A
2N1223	-P	S,SSD,NSC,SOL,HUG	210	To 5	40	25	10.0	.100A	.250W	175J	2.000B	100UA	10V	10	.001A
2N1224	-P	AMP,RCF,RCRA	217	To 33	40	40	10.0	.010A	.120W	100J	100.000B	12UA	12V	60	
2N1225	-P	AMP,RCF,RCRA	217	To 33	60	60	10.0	.010A	.120W	100J	30.000B	12UA	12V	60	
2N1226	-P	BEN,HUG	605	To 3	40	10.0	3.000A	50.000W	100J	.008E	100UA	12V	22	.001A	
2N1227	-P	BEN,HUG	210	To 5	15	15	15.0	.100A	.400W	160J	3.000B	100UA	12V	44	.001A
2N1228	-P	HUG,SSD,NSC,SOL	210	To 5	35	35	35.0	.100A	.400W	160J	3.000B	100UA	12V	22	.001A
2N1229	-P	HUG,SSD,NSC,SOL	210	To 5	35	35	35.0	.100A	.400W	160J	4.000B	100UA	30V	24	.001A
2N1230	-P	HUG,SSD,NSC,SOL	210	To 5	35	35	35.0	.100A	.400W	160J	4.000B	100UA	30V	24	.001A
2N1231	-P	HUG,SSD,NSC,SOL	210	To 5	60	60	60.0	.100A	.400W	160J	2.000B	100UA	50V	44	.001A
2N1232	-P	HUG,SSD,NSC,SOL	210	To 5	60	60	60.0	.100A	.400W	160J	2.000B	100UA	50V	44	.001A
2N1233	-P	HUG,SSD,NSC,SOL	210	To 5	110	110	99.0	.100A	.400W	160J	1.000B	100UA	90V	22	.001A
2N1234	-P	HUG,SSD,NSC,SOL	731	To 53	120	120R	10.0	2.000A	85.000W	200J	.050E	10MA	120V	27	1.000A
2N1235	N	TIH,HUG	903	To 903A	15	15	15.0	1.000W	160J	.800B	100UA	12V	48	.001A	
2N1238	N	HUG,SOL	903	To 903A	35	35	35.0	1.000W	160C	.800B	100UA	28V	22	.001A	
2N1239	N	HUG,SOL	903	To 903A	35	35	35.0	1.000W	160C	.800B	100UA	28V	22	.001A	
2N1240	N	HUG,SOL	903	To 903A	60	60	60.0	1.000W	160C	.800B	100UA	48V	22	.001A	
2N1241	N	HUG,SOL	903	To 903A	60	60	60.0	1.000W	160C	.800B	100UA	48V	22	.001A	
2N1242	N	HUG,SOL	903	To 903A	60	60	60.0	1.000W	160C	.800B	100UA	48V	22	.001A	
2N1243	N	HUG,SOL	903	To 903A	110	110	99.0	1.000W	160C	.800B	100UA	88V	22	.001A	
2N1244	N	HUG,SOL	210	To 5	6	6	2.0	.005A	.030W	150J	5.000G	5UA	10V	30	
2N1247	N	TEC,HUG	210	To 5	6	6	1.0	.005A	.030W	150J	AUD	10UA	3V	30	.010A
2N1248	N	TEC,HUG	210	To 5	6	6	1.0	.005A	.030W	150A	.020E	10UA	60V	30	2.000A
2N1249	N	TEC,HUG	730	To 53	60	60	28.0	5.000A	85.000W	200J	.600B	50UA	20V	225	
2N1250	N	TEC,HUG	210	To 5	20	15R	10.0	.100A	.150W	85J	.350G	50UA	20V	150	
2N1251	N	ETC	210	To 22	20	15R	10.0	.100A	.150W	85J	.350G	50UA	20V	150	
2N1251+	N	ETC	211	To 5	30	20	5.0	.600W	175J	40.000B	100UA	30V	30	150A	
2N1252	N	TIH,BEN,RAY,TEC,HUG	210	To 5	30	30	5.0	.600W	175A	50.000B	100UA	30V	30	150A	
2N1253	N	TIH,BEN,RAY,TEC,HUG	210	To 5	30	30	5.0	.600W	175A	50.000B	200UA	24V	25		
2N1254	N	HUG,TEC	210	To 5	30	30	5.0	.275W	175A	30.000G	200UA	24V	40		
2N1255	N	HUG,TEC	210	To 5	40	40	5.0	.275W	175A	30.000G	200UA	32V	25		
2N1256	N	HUG,TEC	210	To 5	40	40	5.0	.275W	175A	50.000G	200UA	32V	40		
2N1257	N	HUG,TEC	210	To 5	40	40	5.0	.275W	175A	20.0					

Transistor Type No.	N P S	Manufacturer	Lead Ident	Out- line	Maximum (V)			Maximum		Max. T.(°C)	Frequency Resp.(MHz)	Leakage I _{cs} @ V _{cs}	Gain h _{FE} @ I _c
					V _{CE}	V _{BE}	V _{ES}	I _c	Power				
2N1276	N S	ETC,TII,TEC,HUG	210	TO 5	40	30	1.0	.025A	.150W	150J	15.000B	1UA 30V	14
2N1277	N S	ETC,TII,TEC,HUG	210	TO 5	40	30	1.0	.025A	.150W	150J	15.000B	1UA 30V	29
2N1278	N S	ETC,TII,TEC,HUG	210	TO 5	40	30	1.0	.025A	.150W	150J	15.000B	1UA 30V	60
2N1279	N S	ETC,TII,TEC,HUG	210	TO 5	40	30	1.0	.025A	.150W	150J	15.000B	1UA 30V	150
2N1280	P G	ETC	210	TO 5	16	16	10.0	.400A	.200W	85J	50.000B	10UA 10V	80
2N1281	P G	ETC	210	TO 5	16	12	10.0	.400A	.200W	85J	7.000B	10UA 10V	120
2N1282	P G	ETC	210	TO 5	16	12	10.0	.400A	.200W	85J	10.000B	10UA 10V	140
2N1284	P G	ETC	210	TO 5	16	6	10.0	.400A	.200W	85J	5.000B	6UA 20V	60
2N1285	P G	ETC	217	TO 33	40	20R	10.0	.400A	.150W	85J	100.000B	12UA 12V	60
2N1289	N G	SYL	210	TO 33	40	2.5		.010A	.240W	100J	40.000B	5UA 15V	120
2N1291	N G	ETC	217	TO 33	25	15R	15.0	.100A	.075W	85J	2MA 35V	45	.500A
2N1292	N G	ETC	605	TO 3	35	30S	15.0	3.000A	20.000W	100J	AUD	1MA 35V	60
2N1293	N G	ETC	605	TO 3	60	45S	15.0	3.000A	20.000W	100J	AUD	2MA 60V	60
2N1294	N G	ETC	605	TO 3	60	45S	15.0	3.000A	25.000W	100J	AUD	2MA 60V	60
2N1295	N G	ETC	605	TO 3	80	80S	15.0	3.000A	20.000W	95J	AUD	2MA 80V	60
2N1296	N G	ETC	605	TO 3	80	80S	15.0	3.000A	25.000W	100J	AUD	3MA 80V	60
2N1297	N G	ETC	605	TO 3	100	80S	15.0	3.000A	20.000W	85J	AUD	4MA 100V	52
2N1299	N G	ETC	212	TO 5	40	20R	15.0	.200A	.200W	100J	4.000B	3UA 6V	50
2N1300	N G	ETC	210	TO 5	13	12	1.0	.100A	.150W	85J	25.000B	3UA 6V	50
2N1301	P G	RCA	210	TO 5	25	25	4.0	.100A	.150W	85J	35.000B	3UA 6V	50
2N1302	N G	RCA,GIC,TII,ETC,AMP	210	TO 5	25	25	25.0	.300A	.150W	85A	3.000B	6UA 25V	50
2N1303	P G	GEC,RCA,TII,AMP,TAO,ETC	212	TO 5	25	25	25.0	.300A	.150W	85A	5.000B	6UA 25V	50
2N1304	N G	AMP,RCA,TAD,TII,ETC,HUG	212	TO 5	25	25	25.0	.300A	.150W	85A	3.000B	6UA 25V	50
2N1305	P G	GEC,RCA,TAO,AMP,TII,ETC	212	TO 5	25	25	25.0	.300A	.150W	85A	5.000B	6UA 25V	70
2N1306	N G	AMP,RCA,GIC,TAD,TII,ETC	212	TO 5	25	25	25.0	.300A	.150W	85A	10.000B	6UA 25V	100
2N1307	P G	ETC,RCA,GIC,TAD,TII,ETC	212	TO 5	25	25	25.0	.300A	.150W	85A	15.000B	6UA 25V	100
2N1308	N G	AMP,RCA,TAD,TII,ETC	212	TO 5	25	25	25.0	.300A	.150W	85A	10.000B	6UA 25V	100
2N1309	N G	RCA,TII,TAD,ETC,AMP	212	TO 5	25	25	25.0	.300A	.150W	85A	15.000B	6UA 25V	100
2N1310	N G	GIC	210	TO 5	90	20.0		.120W	.85J	2.400W	7UA 5V	42	.005A
2N1311	N G	GIC	210	TO 5	75	20.0		.120W	.85J	2.200W	7UA 5V	38	.005A
2N1312	N G	GIC	210	TO 5	75	20.0		.120W	.85J	2.200W	7UA 5V	46	.005A
2N1313	N G	ETC	210	TO 30	30	15	20.0	.400A	.150W	85J	6.000B	5UA 15V	50
2N1314	P G	PHN,RAD	605	TO 3	32	16	10.0	3.500A	55.000W	100J	100UA	10V	70
2N1316	P G	ETC	210	TO 5	30	15	20.0	.400A	.200W	85J	10.000B	25UA 30V	130
2N1317	P G	ETC	210	TO 5	30	12	15.0	.400A	.200W	85J	10.000B	6UA 12V	120
2N1318	P G	ETC	210	TO 5	10	10	8.0	.400A	.200W	85J	10.000B	20UA 15V	100
2N1319	P G	TII	229	TO 5	20	20	20.0	.400A	.120W	71A	3.000B	6UA 12V	30
2N1321	N G	SYL	430	TO 10	35	30S	15.0	.300A	25.000W	100J	AUD	1MA 25V	60
2N1322	N G	SYL	430	TO 10	60	30S	15.0	.300A	25.000W	100J	AUD	2MA 60V	60
2N1323	N S	HUG	430	TO 10	80	60S	15.0	.300A	25.000W	85J	AUD	3MA 80V	60
2N1335	N S	HUG	430	TO 10	120	45	4.0	.300A	.800W	175J	70.000G	1UA 90V	50
2N1336	N S	TRW,HUG	211	TO 5	120	45	4.0	.300A	.800W	175J	70.000G	1UA 90V	50
2N1337	N S	TRW,HUG	211	TO 5	120	45	4.0	.300A	.800W	175J	70.000G	1UA 90V	50
2N1338	N S	TRW,HUG	211	TO 5	80	25	3.0	.300A	.800W	175J	70.000G	10UA 10V	50
2N1339	N S	TRW,HUG	211	TO 5	120	50	3.0	.300A	.800W	175J	70.000G	1UA 10V	50
2N1340	N S	TRW,HUG	211	TO 5	120	50	3.0	.300A	.800W	175J	70.000G	1UA 10V	50
2N1341	N S	TRW,HUG	211	TO 5	150	65	5.0	.300A	.800W	175J	70.000G	10UA 120V	50
2N1342	N S	TRW,HUG	210	TO 5	20	16	10.0	.400A	.150W	85J	4.000B	6UA 15V	30
2N1343	P G	ETC	210	TO 5	15	10	10.0	.400A	.150W	85J	7.000B	10UA 15V	120
2N1344	P G	ETC	210	TO 5	12	8	8.0	.400A	.150W	85J	10.000B	6UA 12V	55
2N1345	P G	ETC	210	TO 5	12	10	8.0	.400A	.150W	85J	10.000B	6UA 12V	68
2N1346	P G	ETC	210	TO 5	20	12	10.0	.200A	.150W	85J	5.000B	6UA 12V	68
2N1347	P G	ETC	210	TO 5	40	15	25.0	.400A	.200W	85J	10.000B	10UA 12V	68
2N1348	P G	ETC	210	TO 5	40	15	25.0	.400A	.200W	85J	10.000B	10UA 12V	68
2N1349	P G	ETC	210	TO 5	40	18	25.0	.400A	.200W	85J	8.000B	20UA 12V	75
2N1350	P G	ETC	210	TO 5	40	18	25.0	.400A	.200W	85J	8.000B	20UA 12V	75
2N1351	P G	ETC	210	TO 5	30	20	15.0	.200A	.150W	85J	1.250B	5UA 30V	70
2N1352	P G	ETC	210	TO 5	15	10	10.0	.200A	.200W	85J	1.500B	6UA 10V	100
2N1353	P G	ETC	210	TO 5	30	20	15.0	.200A	.200W	85J	3.000B	6UA 15V	100
2N1354	P G	ETC	210	TO 5	30	20	20.0	.200A	.200W	85J	3.000B	6UA 20V	100
2N1355	P G	ETC	210	TO 5	30	20	15.0	.200A	.200W	85J	3.000B	6UA 15V	100
2N1356	P G	ETC	210	TO 5	30	20	20.0	.200A	.200W	85J	3.000B	6UA 20V	100
2N1357	P G	ETC	210	TO 5	30	20	15.0	.200A	.200W	85J	3.000B	6UA 15V	100
2N1358	P G	DEL,MOT,ETC,SOL,HUG	210	TO 5	30	15	20.0	.200A	.200W	85J	10.000B	6UA 15V	100
2N1358A	P G	DEL,ETC,MOT	405	TO 36	80	40	80.0	15.000A	150.000W	100J	1.00B	4MA 80V	60
2N1359	P G	BEN,MOT,HUG,ETC	405	TO 36	100	40	60.0	15.000A	150.000W	110J	1.00B	4MA 100V	40
2N1360	P G	BEN,MOT,ETC,HUG	605	TO 3	50	40S	12.0	3.000A	90.000W	100J	.005E	3MA 40V	60
2N1361	P G	BEN,MOT,ETC,HUG	605	TO 3	50	40S	12.0	3.000A	90.000W	100J	.007E	3MA 75V	60
2N1363	P G	BEN,MOT,ETC,HUG	605	TO 3	100	75S	12.0	3.000A	90.000W	100J	.005E	3MA 75V	90
2N1364	P G	BEN,MOT,ETC,HUG	605	TO 3	120	100S	12.0	3.000A	90.000W	100J	.007E	3MA 100V	60
2N1365	P G	BEN,MOT,ETC,HUG	605	TO 3	120	100S	12.0	3.000A	90.000W	100J	.005E	3MA 100V	60
2N1370	P G	ETC,TII	210	TO 5	25	25R	10.0	.200A	.150W	85J	1.000B	14UA 20V	100
2N1371	P G	ETC,TAD,TII	210	TO 5	45	45R	10.0	.200A	.150W	85J	1.000B	14UA 20V	100
2N1372	P G	ETC,TAD,TII	210	TO 5	25	25	15.0	.200A	.250W	100J	7.50B	7UA 20V	60
2N1373	P G	ETC,TAD,TII	210	TO 5	45	45	25.0	.200A	.250W	100J	7.50B	7UA 20V	60
2N1374	P G	ETC,TAD,TII	210	TO 5	25	25	15.0	.200A	.250W	100J	1.000B	7UA 20V	60
2N1375	P G	ETC,TAD,TII	210	TO 5	45	45	25.0	.200A	.250W	100J	1.000B	7UA 20V	60
2N1376	P G	ETC,TAD,TII	210	TO 5	25	25	15.0	.200A	.250W	100J	1.000B	7UA 20V	60
2N1377	P G	ETC,TAD,TII	210	TO 5	45	45	25.0	.200A	.250W	100J	1.000B	7UA 20V	60
2N1378	P G	ETC,TAD,TII	210	TO 5	45	45	25.0	.200A	.250W	100J	1.000B	7UA 20V	60
2N1379	P G	ETC,TAO,TII	210	TO 5	25	25	15.0	.200A	.250W	100J	1.500B	7UA 12V	200
2N1380	P G	ETC,TAD,TII	210	TO 5	12	12	7.0	.200A	.250W	100J	1.500B	14UA 2V	200
2N1381	P G	ETC,TAD,TII	210	TO 5	25	25	15.0	.200A	.250W	100J	1.500B	14UA 2V	200
2N1382	P G	ETC,TII	210	TO 9	25	25	15.0	.200A	.250W	100J	1.500B	14UA 20V	100
2N1382+	P G	TII	170	TO 9	25	25	15.0	.200A	.250W	85J	2.000B	14UA 20V	90
2N1383	P G	ETC	210	TO 5	25	25	15.0	.200A	.250W	85J	2.000B	14UA 20V	80
2N1383+	P G	TII	170	TO 9	25	25	15.0	.200A	.200W	85J	1.500B	14UA 20V	50
2N1384	N S	ETC	210	TO 11	30	30	1.0	.500A	.240W	85A	20.000G	8UA 12V	50
2N1386	N S	ETC	210	TO 5	25	25S	3.0	.050A	.250W	150J	25.000G	100NA 6V	52
2N1387	N S	ETC	210	TO 5	25	25S	3.0	.050A	.250W	150J	25.000G	100NA 6V	30
2N1391	N S	ETC	210	TO 5	25	18	15.0	.050A	.250W	150J	25.000G	100NA 6V	80
2N1395	P G	AMP,RCA	217	TO 33	40		.5	.010A	.240W	100J	30.000B	12UA 12V	90
2N1397	P G	RCA	217	TO 33	40		.5	.010A	.240W	100J	100.000B	12UA 12V	90
2N1404	P G	TII,ETC	212	TO 5	25	25	20.0	.300A	.200W	85J	30.000B	12UA 12V	90
2N1405	P G	TII	217	TO 12	30	20	1.0	.050A	.075W	100J	250.000G	5UA 12V	10
2N1406	P G	TII	217	TO 12	3								

Transistor Type No.	M P S	G /	S	Manufacturer	Lead Ident	Out- line	Maximum (V)			Maximum		Max. T.(°C)	Frequency Resp.(MHz)	Leakage		Gain h _{FE} @ I _C	
							V _{CE}	V _{BE}	V _{ES}	I _C	Power			I _{ES} @ V _{BE}	I _{ES} @ V _{CE}		
2N1417	N	S		TEC,HUG	210	To 5	15	15	2.0	.050A	.150W	150A		10UA	30V	30	.010A
2N1418	N	S		TEC,HUG	210	To 5	30	30	2.0	.050A	.150W	150A		1UA	15V	30	.001A
2N1420A	N	S		MOT,GIC,TRW,TII,SES,ETC	211	To 5	60	30R	5.0	.600W	.175J	50.000G		10A	30V	180	.150A
2N1425	-P	G		RCA	716	To 7	24	4	.5	.010A	.080W	85J	33.000G	10A	50V	170	
2N1426	-P	G		SPR,HUG	775	To 7	24	4	.5	.010A	.080W	85J	33.000G	12UA	12V	130	
2N1427	-P	G		SPR,HUG	116	To 24	6	6S	6.0	.050A	.025W	85J	50.000G	5UA	6V	50	.001A
2N1429	N	S		SOL,HUG	210	To 5	6	6	6.0		.400W	10.000G	100NA	100UA	2V	37	5.000A
2N1430	N	S		BEN	607	To 41	20	15	1.0	10.000A	50.000W	110J	.005J	200UA	20V	90	
2N1431	N	G		ETC	210	To 2	20	15	10.0	.100A	.180W	75J	.200G	50UA	20V	110	
2N1432	N	G		SVL	217	To 33	45	45	.5	.010A	.100W	100J	7.000G	15UA	45V	60	
2N1433	-P	G		CBS	427	To 10	80	50	28.0	3.500A	35.000W	95J	.200G	2MA	80V	30	
2N1434	-P	G		CBS	427	To 10	80	50	28.0	3.500A	35.000W	95J	.200G	2MA	80V	30	
2N1435	-P	G		CBS	427	To 10	80	50	28.0	3.500A	35.000W	95J	.200G	2MA	80V	30	
2N1439	P	S		SCOT,HUG	210	To 5	50	50	50.0	.100A	.400W	200J	.500B	25NA	15V	13	.001A
2N1440	P	S		NCS,ETC,SOL,HUG	210	To 5	60	50	60.0	.100A	.400W	200J	1.000B	25NA	60V	16	
2N1441	P	S		NCS,ETC,SOL,HUG	210	To 5	50	35	50.0	.100A	.400W	200J	1.000B	25NA	50V	48	
2N1442	P	S		NCS,ETC,SOL,HUG	210	To 5	50	15	50.0	.100A	.400W	200J	1.000B	25NA	50V	70	
2N1443	P	S		NCS,SOL,HUG	210	To 5	50	15	50.0	.100A	.400W	200J	1.000B	25NA	50V	70	
2N1445	N	S		TII,HUG	211	To 5	120	8.0	8.0	.750A	.800W	200J	.075E	10UA	120V	40	.200A
2N1446	N	S		ETC	210	To 5	45	25	15.0	.400A	.200W	85J	1.000B	10UA	30V	40	
2N1447	P	G		ETC	210	To 5	45	25	15.0	.400A	.200W	85J	1.500B	10UA	30V	40	
2N1448	P	G		ETC	210	To 5	45	25	15.0	.400A	.200W	85J	2.000B	10UA	30V	60	
2N1449	P	G		ETC	210	To 5	45	25	15.0	.400A	.200W	85J	2.250B	10UA	30V	100	
2N1450	P	G		ETC	210	To 5	30	20	1.0	.100A	.120W	85J		10UA	7V	40	.010A
2N1450+	P	G		SVL	217	To 33	30	20	1.0	.100A	.120W	100J	300A	100UA	30V	40	
2N1451	P	G		ETC	210	To 5	45	25	3.0	.100A	.200W	85J	3.000B	5UA	15V	160	
2N1452	P	G		ETC	210	To 5	45	25	10.0	.400A	.200W	85J	1.150B	15UA	45V	60	
2N1459	P	S		SSD,SOL,HUG	210	To 5	40	35	40.0	.100A	.250W	175J	2.000B	25NA	35V	50	
2N1471	N	S		ETC	210	To 5	15	12	7.0	.200A	.200W	85J	3.000B	5UA	15V	160	
2N1472	N	S		ETC	211	To 5	25	25	3.0	.100A	.200W	85J	500NA	10V	30	.010A	
2N1473	N	S		ETC	211	To 5	40	40R	1.0	.400A	.250W	85J	4.000B	50UA	40V	38	.400A
2N1474	N	S		SSD,NCS,SOL,HUG	210	To 5	60	60	60.0	.100A	.250W	175J	1.000B	50NA	50V	30	.001A
2N1474A	N	S		SSD,SOL,HUG	210	To 5	60	60	60.0	.100A	.250W	175J	2.000B	50NA	50V	26	.001A
2N1475	P	S		SSD,NCS,SOL,HUG	210	To 5	60	60	60.0	.100A	.250W	175J	1.000B	50NA	50V	24	.001A
2N1476	P	S		SSD,NCS,SOL,HUG	210	To 5	100	100	100.0	.100A	.250W	175J	1.000B	200NA	80V	44	.001A
2N1477	P	G		ETC	210	To 5	100	100	100.0	.100A	.250W	175J	1.000B	200NA	80V	44	.001A
2N1478	P	G		ETC	211	To 5	30	20R	20.0	5.000A	.250W	100J	3.000B	25UA	30V	60	.100A
2N1479	N	S		AMF,RCA,TEC,HUG	211	To 5	60	40	12.0	1.500A	5.000W	200J	1.500B	10UA	30V	36	
2N1480	N	S		AMF,RCA,TEC,HUG	211	To 5	100	55	12.0	1.500A	5.000W	200J	1.500B	10UA	30V	36	
2N1481	N	S		AMF,RCA,TEC,HUG	211	To 5	100	55	12.0	1.500A	5.000W	200J	1.500B	10UA	30V	70	
2N1482	N	S		AMF,RCA,TEC,HUG	211	To 5	100	55	12.0	1.500A	5.000W	200J	1.500B	10UA	30V	70	
2N1483	N	S		AMF,RCA,ETC	171	To 8	60	40	12.0	3.000A	25.000W	200J	1.250B	15UA	30V	36	.750A
2N1484	N	S		AMF,ETC	171	To 8	100	55	12.0	3.000A	25.000W	200J	1.250B	15UA	30V	70	.750A
2N1485	N	S		AMF,RCA,ETC	171	To 8	60	40	12.0	3.000A	25.000W	200J	1.250B	15UA	30V	70	.750A
2N1486	N	S		AMF,RCA,ETC	171	To 8	60	40	12.0	3.000A	25.000W	200J	1.250B	15UA	30V	70	.750A
2N1487	N	S		AMF,RCA,ETC	171	To 8	60	40	12.0	3.000A	25.000W	200J	1.250B	15UA	30V	70	.750A
2N1488	N	S		AMF,BEN,ETC,RCA,HUG	605	To 3	60	40	10.0	6.000A	75.000W	200J	1.000B	25UA	30V	30	1.500A
2N1489	N	S		AMF,BEN,ETC,RCA,HUG	605	To 3	60	40	10.0	6.000A	75.000W	200J	1.000B	25UA	30V	30	1.500A
2N1490	N	S		AMF,BEN,ETC,RCA,HUG	605	To 3	100	55	10.0	6.000A	75.000W	200J	1.000B	25UA	30V	40	1.500A
2N1491	N	S		AMF,BEN,ETC,RCA,HUG	605	To 3	100	55	10.0	6.000A	75.000W	200J	1.000B	25UA	30V	40	1.500A
2N1492	N	S		RCA	217	To 12	60	2	1.0	.005A	.500W	175C	250.000B	10UA	12V	60	
2N1493	N	S		RCA	217	To 12	60	2	1.0	.005A	.500W	175C	275.000B	10UA	12V	60	
2N1494	N	S		RCA	217	To 12	100	4.5	.005A	.500W	175C	300.000B	10UA	12V	60		
2N1499	P	G		MOT	211	211P	20	15	4.0	.500A	.750W	100J	110.000G	7UA	5V	35	.400A
2N1499A	P	G		MOT	211	211P	20	15	4.0	.500A	.750W	100J	110.000G	7UA	5V	50	.200A
2N1495	P	G		MOT	210	To 5	40	25	4.0	.500A	.300W	100J	150.000G	7UA	5V	50	.200A
2N1496	P	G		MOT	211	211P	40	25	4.0	.500A	.750W	100J	150.000G	7UA	5V	50	.200A
2N1499	P	G		ETC,HUG	170	To 9	20	15S	2.0	.050A	.025W	85J	100.000G	100UA	20V	50	.040A
2N1499A	P	G		SPR,ETC,HUG	170	To 9	30	20	2.0	.100A	.075W	100J	150.000G	3UA	5V	80	.010A
2N1499B	P	G		SPR,ETC,HUG	170	To 9	30	20	2.0	.100A	.075W	100J	150.000G	3UA	5V	80	.010A
2N1500	P	G		SPR,ETC,MOT,HUG	170	To 9	15	12S	2.0	.050A	.060W	100J	120.000G	5UA	5V	50	
2N1501	P	G		SOL,HUG	427	To 10	60	40	28.0	3.500A	32.000W	100J	.200G	2MA	60V	60	2.000A
2N1502	P	G		SOL,HUG	427	To 10	40	40	28.0	3.500A	32.000W	100J	.200G	2MA	40V	60	2.000A
2N1505				SEE RF POWER SECTION													
2N1506				SEE RF POWER SECTION													
2N1506A				SEE RF POWER SECTION													
2N1507	N	S		TRW,TII,RAY,ETC,HUG	211	To 5	60	25	5.0	.020A	.60W	175J	50.000G	1UA	30V	160	
2N1510	N	S		GE	405	To 36	75	70R	8.0	6.000A	75.000W	200A	1.000B	25UA	30V	30	
2N1511	N	S		STC,HUG	405	To 36	100	50	10.0	6.000A	75.000W	200A	1.000B	25UA	30V	30	
2N1512	N	S		STC,HUG	405	To 36	100	50	10.0	6.000A	75.000W	200A	1.000B	25UA	30V	30	
2N1513	N	S		STC,HUG	405	To 36	100	50	10.0	6.000A	75.000W	200A	1.000B	25UA	30V	30	
2N1514	N	S		STC,HUG	405	To 36	100	50	10.0	6.000A	75.000W	200A	1.000B	25UA	30V	30	
2N1518	P	G		DEL,ETC,SOL	405	To 36	50	40	30.0	25.000A	150.000W	100J	.004E	4MA	50V	30	15.000A
2N1519	P	G		DEL,ETC,SOL	405	To 36	50	40	30.0	25.000A	150.000W	100J	.004E	4MA	80V	34	15.000A
2N1520	P	G		DEL,ETC,SOL	405	To 36	50	40	30.0	25.000A	150.000W	100J	.004E	4MA	50V	30	15.000A
2N1521	P	G		DEL,ETC,SOL	405	To 36	80	60	30.0	35.000A	150.000W	100J	.004E	4MA	80V	34	15.000A
2N1522	P	G		DEL,ETC,SOL	405	To 36	80	60	30.0	35.000A	150.000W	100J	.004E	4MA	50V	30	15.000A
2N1523	P	G		DEL,ETC,SOL	405	To 36	80	60	30.0	35.000A	150.000W	100J	.004E	4MA	80V	50	15.000A
2N1524	P	G		DEL,ETC,SOL	405	To 36	80	60	30.0	35.000A	150.000W	100J	.004E	4MA	50V	30	15.000A
2N1525	-P	G		RCA	120	To 1	24	.5	.010A	.080W	71A	33.000B	16UA	12V	60		
2N1526	-P	G		RCA	55	To 40	24	.5	.010A	.080W	71A	33.000B	16UA	12V	60		
2N1527	-P	G		RCA	120	To 1	24	.5	.010A	.080W	71A	33.000B	16UA	12V	130		
2N1529	P	G		MOT,ETC,TII,HUG	605	To 3	40	20	20.0	5.000A	90.000W	100J	.010E	2MA	25V	30	3.000A
2N1529A	P	G		MOT,BEN,HUG													

Transistor Type No.	N P	G S	Manufacturer	Lead Ident	Out line	Maximum (V)			Maximum		Max T (C)	Frequency Resp (MHz)	Leakage			Gain h _{FE} @ I _C	
						V _{CE}	V _{BE}	V _{ES}	I _C	Power			I _{CE} @ V _{CE}	I _{BE} @ V _{BE}	I _{ES} @ V _{ES}		
2N1543	P	G	BEN, OEL, MOT, TII, ETC, SOL	605	To 3	120	60	12.0	5.000A	90.000W	100J	.200G	2MA	80V	75	3.000A	
2N1544	P	G	BEN, OEL, MOT, ETC, TII, SOL	605	To 3	40	20	12.0	5.000A	90.000W	100J	.002E	2MA	25V	110	3.000A	
2N1544A	P	G	MOT, BEN, SOL, HUG	605	To 3	40	20	20.0	5.000A	90.000W	100J	.002E	2MA	25V	100	3.000A	
2N1545	P	G	BEN, OEL, MOT, ETC, TII, SOL	605	To 3	60	30	12.0	5.000A	90.000W	100J	.002E	2MA	40V	110	3.000A	
2N1545A	P	G	MOT, BEN, SOL, HUG	605	To 3	60	30	12.0	5.000A	90.000W	100J	.002E	2MA	40V	110	3.000A	
2N1546	P	G	BEN, OEL, MOT, ETC, TII, SOL	605	To 3	60	30	30.0	5.000A	90.000W	100J	.004E	2MA	40V	100	3.000A	
2N1546A	P	G	MOT, BEN, SOL, HUG	605	To 3	80	40	12.0	5.000A	90.000W	100J	.002E	2MA	55V	110	3.000A	
2N1547	P	G	BEN, OEL, MOT, ETC, TII, SOL	605	To 3	100	50	12.0	5.000A	90.000W	100J	.004E	2MA	55V	100	3.000A	
2N1547A	P	G	MOT, BEN, SOL, HUG	605	To 3	100	50	50.0	5.000A	90.000W	100J	.002E	2MA	65V	110	3.000A	
2N1548	P	G	BEN, MOT, ETC, TII, SOL, HUG	605	To 3	120	60	12.0	5.000A	90.000W	100J	.002E	2MA	80V	110	3.000A	
2N1549	P	G	BEN, MOT, ETC, SOL, HUG	605	To 3	40	20	20.0	15.000A	90.000W	100J	.010E	3MA	25V	20	10.000A	
2N1549A	P	G	MOT, BEN, SOL, HUG	605	To 3	40	20	20.0	15.000A	90.000W	100J	.010E	3MA	25V	20	10.000A	
2N1550	P	G	BEN, MOT, ETC, SOL, HUG	605	To 3	60	30	30.0	15.000A	90.000W	100J	.010E	3MA	25V	20	10.000A	
2N1550A	P	G	MOT, BEN, SOL, HUG	605	To 3	60	30	30.0	15.000A	90.000W	100J	.010E	3MA	25V	20	10.000A	
2N1551	P	G	BEN, MOT, ETC, SOL, HUG	605	To 3	80	40	40.0	15.000A	90.000W	100J	.010E	3MA	40V	20	10.000A	
2N1551A	P	G	MOT, BEN, SOL, HUG	605	To 3	80	40	40.0	15.000A	90.000W	100J	.010E	3MA	40V	20	10.000A	
2N1552	P	G	BEN, MOT, ETC, SOL, HUG	605	To 3	100	50	40.0	15.000A	90.000W	100J	.010E	3MA	55V	20	10.000A	
2N1552A	P	G	MOT, BEN, SOL, HUG	605	To 3	100	50	50.0	15.000A	90.000W	100J	.010E	3MA	55V	20	10.000A	
2N1553	P	G	BEN, MOT, ETC, SOL, HUG	605	To 3	40	20	12.0	15.000A	90.000W	100J	.006E	3MA	25V	44	10.000A	
2N1553A	P	G	MOT, BEN, SOL, HUG	605	To 3	40	20	12.0	15.000A	90.000W	100J	.006E	3MA	25V	44	10.000A	
2N1554	P	G	BEN, MOT, ETC, SOL, HUG	605	To 3	60	30	12.0	15.000A	90.000W	100J	.006E	3MA	25V	44	10.000A	
2N1554A	P	G	MOT, BEN, SOL, HUG	605	To 3	60	30	12.0	15.000A	90.000W	100J	.006E	3MA	25V	44	10.000A	
2N1555	P	G	BEN, MOT, ETC, SOL, HUG	605	To 3	80	40	12.0	15.000A	90.000W	100J	.006E	3MA	40V	44	10.000A	
2N1555A	P	G	MOT, BEN, SOL, HUG	605	To 3	80	40	12.0	15.000A	90.000W	100J	.006E	3MA	40V	44	10.000A	
2N1556	P	G	BEN, MOT, ETC, SOL, HUG	605	To 3	100	50	12.0	15.000A	90.000W	100J	.010E	3MA	55V	20	10.000A	
2N1556A	P	G	MOT, BEN, SOL, HUG	605	To 3	100	50	50.0	15.000A	90.000W	100J	.006E	3MA	65V	44	10.000A	
2N1557	P	G	BEN, MOT, ETC, SOL, HUG	605	To 3	40	20	12.0	15.000A	90.000W	100J	.005E	3MA	25V	70	10.000A	
2N1557A	P	G	MOT, BEN, SOL, HUG	605	To 3	40	20	12.0	15.000A	90.000W	100J	.005E	3MA	25V	70	10.000A	
2N1558	P	G	BEN, MOT, ETC, SOL, HUG	605	To 3	60	30	12.0	15.000A	90.000W	100J	.005E	3MA	40V	70	10.000A	
2N1558A	P	G	MOT, BEN, SOL, HUG	605	To 3	60	30	12.0	15.000A	90.000W	100J	.005E	3MA	40V	70	10.000A	
2N1559	P	G	BEN, MOT, ETC, SOL, HUG	605	To 3	60	30	30.0	15.000A	90.000W	100J	.005E	3MA	40V	74	10.000A	
2N1559A	P	G	MOT, BEN, SOL, HUG	605	To 3	80	40	12.0	15.000A	90.000W	100J	.005E	3MA	55V	70	10.000A	
2N1560	P	G	BEN, MOT, ETC, SOL, HUG	605	To 3	100	50	12.0	15.000A	90.000W	100J	.005E	3MA	55V	74	10.000A	
2N1560A	P	G	MOT, BEN, SOL, HUG	605	To 3	100	50	50.0	15.000A	90.000W	100J	.005E	3MA	65V	74	10.000A	
2N1561	P	G	MOT	171	1710	25	25	3.0	250A	250W	100J	500.000G	10UA	10V	3	.050A	
2N1562	P	G	AMC, CSF, TII, TRW, ETC, NSC	211	To 5	60	60	2.0	250A	250W	100J	450.000G	10UA	10V	3	.050A	
2N1565	N	S	AMC, CSF, TII, TRW, ETC, NSC	211	To 5	80	60	5.0	500A	600W	175J	30.000G	1UA	40V	36	.005A	
2N1566	N	S	AMC, TII, TRW, ETC, NSC, TEC	211	To 5	80	60	5.0	500A	600W	175J	30.000G	1UA	40V	36	.005A	
2N1572	N	S	AMC, CSF, TII, ETC, TEC	211	To 5	80	60	8.0	100A	600W	175J	100.000G	500NA	40V	12	.005A	
2N1573	N	S	AMC, CSF, TII, ETC, TEC	211	To 5	125	80	5.0	600W	175J	30.000G	1UA	40V	28	.005A		
2N1574	N	S	AMC, CSF, TII, ETC, TEC	211	To 5	125	80	5.0	600W	175J	60.000G	1UA	40V	35	.005A		
2N1586	N	S	ETC, TII, TEC, HUG	210	To 5	60	30	1.0	.025A	125W	100J	4.000B	1UA	15V	16	.001A	
2N1587	N	S	ETC, TII, TEC, HUG	210	To 5	60	30	1.0	.025A	125W	100J	4.000B	1UA	15V	16	.001A	
2N1588	N	S	ETC, TII, TEC, HUG	210	To 5	15	1.0	1.0	.025A	125W	100J	4.000B	1UA	60V	16	.001A	
2N1589	N	S	ETC, TII, TEC, HUG	210	To 5	15	1.0	1.0	.025A	125W	100J	4.000B	1UA	60V	16	.001A	
2N1590	N	S	ETC, TII, TEC, HUG	210	To 5	30	1.0	1.0	.025A	125W	100J	5.000B	1UA	30V	39	.001A	
2N1591	N	S	ETC, TII, TEC, HUG	210	To 5	60	1.0	1.0	.025A	125W	100J	6.000B	1UA	15V	129	.001A	
2N1592	N	S	ETC, TII, TEC, HUG	210	To 5	30	1.0	1.0	.025A	125W	100J	6.000B	1UA	30V	129	.001A	
2N1593	N	S	ETC, TII, TEC, HUG	210	To 5	60	1.0	1.0	.025A	125W	100J	6.000B	1UA	15V	129	.001A	
2N1594	N	S	ETC, TII, TEC, HUG	210	To 5	60	1.0	1.0	.025A	125W	100J	6.000B	1UA	30V	129	.001A	
2N1605	P	G	RCA, TAD, ETC, TII	212	To 5	25	24	12.0	200A	150W	100J	4.000B	5UA	12V	70	.001A	
2N1605A	P	G	RCA, TAD, ETC	212	To 5	40	60	12.0	200A	200W	100J	4.000B	10UA	40V	70	.001A	
2N1609	P	G	DEL	631	To 37	80	60	40.0	1.500A	7.500W	100J	.017E	100UA	80V	50	.005A	
2N1610	P	G	DEL	631	To 37	60	40	20.0	1.500A	7.500W	100J	.017E	100UA	80V	50	.005A	
2N1611	P	G	DEL	631	To 37	60	40	20.0	1.500A	7.500W	100J	.017E	100UA	80V	50	.005A	
2N1612	P	G	DEL	631	To 37	60	40	20.0	1.500A	7.500W	100J	.015E	100UA	60V	90	.005A	
2N1613	N	S	GEC, RCA, RAY, TII, MOT	211	To 5	75	50R	7.0	1.000A	800W	200J	60.000G	10NA	60V	70	.150A	
2N1613A	N	S	RAY	211	To 5	125	50R	7.0	1.000G	200J	60.000G	10NA	60V	70	.150A		
2N1614	N	S	ETC	210	To 5	65	40R	12.0	.300A	240W	85J	1.500B	25UA	30V	30	.150A	
2N1615	N	S	ETC, TEC, HUG	261	To 5	57B	65	40R	12.0	.300A	240W	100J	5.000B	25UA	25V	26	.150A
2N1616	N	S	AMF, TEC, BEN, SES, ETC, HUG	561	To 61	100	80	8.0	200A	600W	175J	2.000G	2UA	60V	38	.005A	
2N1617	N	S	AMF, TEC, BEN, SES, ETC, HUG	561	To 61	80	70	8.0	5.000A	60.000W	150J	3.000G	10MA	60V	40	2.000A	
2N1617A	N	S	BEN, TEC, HUG	561	To 61	100	100	8.0	5.000A	60.000W	150J	3.000G	10MA	60V	40	2.000A	
2N1618	N	S	AMF, BEN, TEC, SES, ETC, HUG	561	To 61	100	100	8.0	5.000A	60.000W	175C	3.000G	200UA	80V	36	2.000A	
2N1618A	N	S	BEN, TEC, HUG	561	To 61	100	100	8.0	7.500A	85.000W	200J	3.000G	200UA	100V	36	2.000A	
2N1620	N	S	TEC, BEN, ETC, HUG	561	To 61	100	80	8.0	5.000A	60.000W	175J	3.000G	1MA	100V	30	2.000A	
2N1623	P	G	HUG, ETC, NSC, SOL	210	To 5	50	20	20.0	.050A	250W	160J	1.00B	1UA	30V	24	.001A	
2N1624	N	S	ETC	210	To 5	45	15.0	15.0	.150W	100J	5.000B	10UA	25V	120	.001A		
2N1631	P	G	RCA	55	To 40	34	5	.010A	.080W	71A	45.000B	16UA	12V	80	.001A		
2N1632	P	G	RCA	55	To 40	134	5	.010A	.080W	71A	40.000B	16UA	12V	80	.001A		
2N1633	P	G	RCA	120	To 1	34	5	.010A	.080W	71A	40.000B	16UA	12V	75	.001A		
2N1634	P	G	RCA	120	To 1	34	5	.010A	.080W	71A	45.000B	16UA	12V	75	.001A		
2N1635	P	G	RCA	120	To 1	34	5	.010A	.080W	71A	45.000B	16UA	12V	75	.001A		
2N1636	P	G	RCA	120	To 1	34	5	.010A	.080W	71A	45.000B	16UA	12V	75	.001A		
2N1637	P	G	RCA	120	To 1	34	5	.010A	.080W	71A	45.000B	16UA	12V	75	.001A		
2N1638	P	G	RCA	120	To 1	34	5	.010A	.080W	71A	45.000B	16UA	12V	75	.001A		
2N1639	P	G	RCA	120	To 1	34	5	.010A	.080W	71A	45.000B	16UA	12V	75	.001A		
2N1643	N	S	SOL, HUG	210	To 5	25	25	20.0	.400W	1.000B	1.000B	1NA	16V	16	.001A		
2N1647	N	S	ETC, HUG	571	1715	15	12	2.0	.050A	150W	100J	HS SW	3UA	5V	40	.001A	
2N1648	N	S	TEC, ETC, HUG	505	505A	80	60	6.0	40.000G	175J	10.000B	100UA	60V	30	500A		
2N1649	N	S	TEC, ETC, HUG	505	505A	120	80	6.0	40.000G	175J							

Transistor Type No.	H P	N S	Manufacturer	Lead Ident	Out- line	Maximum (V)			Maximum		Max.	Frequency	Leakage		Gain	
						V _{CE}	V _{BE}	V _{ES}	I _B	Power	T _C (°C)	Resp.(MHz)	I _{BO} @ V _{CE}	I _{CO} @ I _B	h _{FE} @ I _B	
2N1692	P	G	MOT	546	546B	25	25	3.0	250A	3.000W	100	500.000G	10UA	10V	3	.050A
2N1693	P	G	MOT	546	546B	25	25	2.0	250A	3.000W	100	450.000G	10UA	10V	3	.050A
2N1694	N	G	GEC	12	12A	20	20	10.0	0.75A	.025W	85	3.000B	1UA	15V	25	50
2N1699	N	G	SVL	212	TO 47	25	20R	15.0	100A	.200W	100	8.000B	10UA	15V	30	80
2N1700	N	S	RCA, ETC, TEC	211	TO 5	80	40	6.0	1.000A	5.000W	200	1.200B	10UA	25V	90	2.000A
2N1701	N	S	RCF, RCA, ETC	171	TO 5	80	40	6.0	2.500A	25.000W	200	1.000B	100UA	30V	50	40
2N1702	N	S	RCB, BEN, ETC	605	TO 3	60	40	6.0	5.000A	75.000W	200	1.000B	200UA	30V	40	80
2N1703	N	S	BEN	405	TO 36	60	40	6.0	5.000A	75.000W	200	1.000B	200UA	30V	40	80
2N1704	N	S	ETC	211	TO 5	45	45	5.0	4.00A	.200W	100	12.500G	10UA	10V	100	.001A
2N1705	P	G	MOT, ETC	212	TO 5	25	18R	5.0	4.00A	.200W	100	3.000B	10UA	10V	90	.010A
2N1706	P	G	MOT, ETC	212	TO 5	30	25R	10.0	4.00A	.200W	100	3.000B	15UA	25V	90	.020A
2N1707	N	S	ITT, MOT, HUG, FSC	211	TO 46	25	12R	3.0	2.000A	1.000W	175C	200.000G	25NA	15V	40	.010A
2N1709	N	S	SEE RF POWER SECTION													
2N1710	N	S	AMC, GEC, RCA, RAY, TII, MOT	211	TO 5	75	50R	7.0	1.000A	.800W	200	70.000G	10NA	60V	175	.150A
2N1711	N	S	RAY, HUG	211	TO 5	75	50R	7.0	1.000W	1.000W	200	70.000G	10NA	60V	175	.150A
2N1711B	N	S	RAY	211	TO 5	120	50	7.0	.750A	.800W	175	16.000G	2UA	60V	40	
2N1714	N	S	TII, SSP, BEN, TEC	211	TO 5	100	100	6.0	.750A	.800W	175	16.000G	2UA	60V	40	
2N1715	N	S	TII, SSP, BEN, TEC	211	TO 5	60	60	6.0	.750A	.800W	175	16.000G	2UA	60V	80	
2N1716	N	S	TII, SSP, TEC	211	TO 5	100	100	6.0	.750A	.800W	175	16.000G	2UA	60V	80	
2N1717	N	S	TII, SSP, TEC	541	5410	60	60	6.0	.750A	.800W	175	16.000G	2UA	60V	80	
2N1718	N	S	TII, SSP, BEN, TEC	541	5410	60	60	6.0	.750A	.800W	175	16.000G	2UA	60V	80	
2N1719	N	S	TII, SSP, TEC, HUG	541	5410	100	100	6.0	.750A	10.000W	175	16.000G	2UA	60V	80	
2N1720	N	S	TII, SSP, TEC, HUG	541	5410	60	60	6.0	.750A	10.000W	175	16.000G	2UA	60V	80	
2N1721	N	S	TII, SSP, TEC, HUG	541	5410	100	100	6.0	.750A	10.000W	175	16.000G	2UA	60V	80	
2N1722	N	S	TII, BEN, STC, ETC, TEC, HUG	731	TO 53	120	80	10.0	5.000A	50.000W	175	10.000G	1MA	3V	60	2.000A
2N1722A	N	S	TII, STC, TEC, HUG	731	TO 53	180	120	10.0	5.000A	50.000W	175	10.000G	1MA	3V	60	2.000A
2N1723	N	S	TII, BEN, STC, TEC, HUG	561	TO 61	120	80	10.0	5.000A	50.000W	175	10.000G	1MA	3V	60	2.000A
2N1724	N	S	TII, BEN, STC, SES, ETC, FSC	561	TO 61	120	80	10.0	5.000A	50.000W	175	10.000G	1MA	3V	60	2.000A
2N1724A	N	S	TII, TEC, STC, SES, HUG	561	TO 61	120	120	10.0	5.000A	50.000W	175	10.000G	1MA	3V	60	2.000A
2N1725	N	S	TEC, TII, BEN, STC, SES, FSC	561	TO 61	120	80	10.0	5.000A	50.000W	175	10.000G	1MA	3V	60	2.000A
2N1725	N	S	TEC, TII, BEN, STC, SES, FSC	561	TO 61	120	80	10.0	5.000A	50.000W	175	10.000G	1MA	3V	60	2.000A
2N1726	P	G	SPR, ETC, HUG	170	TO 9	20	20S	1.0	.050A	.060W	100	100.000G	10UA	5V	40	
2N1727	P	G	SPR, ETC, HUG	170	TO 9	20	20S	.5	.050A	.060W	100	100.000G	10UA	5V	80	
2N1728	P	G	SPR, ETC, HUG	170	TO 9	20	20S	.5	.050A	.060W	100	100.000G	10UA	5V	80	
2N1742	P	G	SPR, ETC, MOT, HUG	170	TO 9	20	20S	.5	.050A	.060W	100	980.000G	10UA	10V	32	
2N1743	P	G	SPR, ETC, HUG	170	TO 9	20	20S	.5	.050A	.060W	100	VHFOSC	10UA	10V	32	
2N1744	P	G	SPR, ETC, HUG	170	TO 9	20	20S	.5	.050A	.060W	100	VHFOSC	10UA	10V	32	
2N1745	P	G	SPR, ETC, HUG	170	TO 9	20	20S	.5	.050A	.060W	100	200.000G	10UA	10V	32	
2N1746	P	G	SPR, ETC, HUG	170	TO 9	20	20S	1.0	.050A	.060W	100	100.000G	10UA	10V	40	.01A
2N1747	P	G	SPR, ETC, HUG	170	TO 9	20	20S	.5	.050A	.060W	100	80.000G	10UA	12V	88	.01A
2N1748	P	G	SPR, ETC, HUG	170	TO 9	25	25S	1.0	.050A	.060W	100	100.000G	10UA	12V	88	.01A
2N1748A	P	G	SPR, ETC, HUG	170	TO 9	25	25S	1.0	.050A	.060W	100	80.000G	10UA	12V	88	.01A
2N1749	P	G	SPR, ETC, HUG	170	TO 9	40	40S	1.0	.050A	.075W	100	80.000G	10UA	12V	68	.01A
2N1751	P	G	BEN, MOT	605	TO 3	80	60	25.0	2.500A	100.000W	110	1.500B	5MA	80V	50	20.000A
2N1752	P	G	SPR, ETC, HUG	170	TO 9	12	12S	2.0	.050A	.060W	100	50.000G	10UA	15V	23	
2N1754	P	G	SPR, ETC, HUG, MOT	170	TO 9	12	12S	2.0	.050A	.060W	100	50.000G	10UA	15V	23	
2N1755	P	G	SPR, ETC, HUG, MOT	170	TO 9	12	12S	2.0	.050A	.060W	100	50.000G	10UA	15V	23	
2N1756	P	G	CLE	640	640A	40	40	30.0	3.000A	30.000W	100	.015E	50UA	2V	50	
2N1757	P	G	CLE	640	640A	60	40	30.0	3.000A	30.000W	100	.015E	50UA	2V	50	
2N1758	P	G	CLE	640	640A	60	55	30.0	3.000A	30.000W	100	.015E	50UA	2V	50	
2N1759	P	G	CLE	640	640A	60	30	30.0	3.000A	30.000W	100	.015E	50UA	2V	50	
2N1800	P	G	SOL	640	640A	40	25	30.0	10.000A	28.000W	80					5.000A
2N1801	P	G	SOL	640	640A	60	40	30.0	10.000A	28.000W	80					5.000A
2N1802	P	G	SOL	640	640A	60	55	30.0	10.000A	28.000W	80					5.000A
2N1803	P	G	SOL	640	640A	60	55	30.0	10.000A	28.000W	80					5.000A
2N1804	P	G	SOL	640	640A	60	55	30.0	10.000A	28.000W	80					5.000A
2N1805	P	G	SOL	640	640A	60	55	30.0	10.000A	28.000W	80					5.000A
2N1806	P	G	SOL	640	640A	60	55	30.0	10.000A	28.000W	80					5.000A
2N1807	P	G	SOL	640	640A	60	55	30.0	10.000A	28.000W	80					5.000A
2N1808	P	G	SOL	640	640A	60	55	30.0	10.000A	28.000W	80					5.000A
2N1809	P	G	SOL	640	640A	60	55	30.0	10.000A	28.000W	80					5.000A
2N1810	P	G	SOL	640	640A	60	55	30.0	10.000A	28.000W	80					5.000A
2N1811	P	G	SOL	640	640A	60	55	30.0	10.000A	28.000W	80					5.000A
2N1812	P	G	SOL	640	640A	60	55	30.0	10.000A	28.000W	80					5.000A
2N1813	P	G	SOL	640	640A	60	55	30.0	10.000A	28.000W	80					5.000A
2N1814	P	G	SOL	640	640A	60	55	30.0	10.000A	28.000W	80					5.000A
2N1815	P	G	SOL	640	640A	60	55	30.0	10.000A	28.000W	80					5.000A
2N1816	P	G	SOL	640	640A	60	55	30.0	10.000A	28.000W	80					5.000A
2N1817	P	G	SOL	640	640A	60	55	30.0	10.000A	28.000W	80					5.000A
2N1818	P	G	SOL	640	640A	60	55	30.0	10.000A	28.000W	80					5.000A
2N1819	P	G	SOL	640	640A	60	55	30.0	10.000A	28.000W	80					5.000A
2N1820	P	G	SOL	640	640A	60	55	30.0	10.000A	28.000W	80					5.000A
2N1821	P	G	SOL	640	640A	60	55	30.0	10.000A	28.000W	80					5.000A
2N1822	P	G	SOL	640	640A	60	55	30.0	10.000A	28.000W	80					5.000A
2N1823	P	G	SOL	640	640A	60	55	30.0	10.000A	28.000W	80					5.000A
2N1824	P	G	SOL	640	640A	60	55	30.0	10.000A	28.000W	80					5.000A
2N1825	P	G	SOL	640	640A	60	55	30.0	10.000A	28.000W	80					5.000A
2N1826	P	G	SOL	640	640A	60	55	30.0	10.000A	28.000W	80					5.000A
2N1830	P	G	SOL	640	640A	60	55	30.0	10.000A	28.000W	80					5.000A
2N1831	P	G	SOL	640	640A	60	55	30.0	10.000A	28.000W	80					5.000A
2N1832	P	G	SOL	640	640A	60	55	30.0	10.000A	28.000W	80					5.000A
2N1833	P	G	SOL	640	640A	60	55	30.0	10.000A	28.000W	80					5.000A
2N1834	P	G	SOL	640	640A	60	55	30.0	10.000A	28.000W	80					5.000A
2N1835	P	G	SOL	640	640A	60	55	30.0	10.000A	28.000W	80					5.000A
2N1836	P	G	SOL	640	640A	60	55	30.0	10.000A	28.000W	80					5.000A
2N1837	P	G	SOL	640	640A	60	55	30.0	10.000A	28.000W	80					5.000A
2N1838	P	G	SOL	640	640A	60	55	30.0	10.000A	28.000W						

Transistor Type No.	N P S	Manufacturer	Lead Ident	Out- line	Maximum (V)			Maximum		Max. T.(°C)	Frequency Resp.(MHz)	Leakage		Gain h_{FE} @ I_C
					V_{CE}	V_{BE}	V_{ES}	I_C	Power			I_{BCE} @ V_{CE}	I_{CBO}	
2N2077	P	MOT.ETC.OEL.SOL.HUG	405	To 36	50	45	25.0	15.000A	170.000W	110K	.005E	15MA	50V	50 1.200A
2N2077A	P	MOT	405	To 36	50	45	25.0	15.000A	170.000W	110J	.005E	15MA	50V	50 1.200A
2N2078	P	MOT.ETC.OEL.SOL.HUG	405	To 36	40	25	20.0	15.000A	170.000W	110J	.005E	15MA	40V	50 1.200A
2N2078A	P	MOT	405	To 36	40	25	20.0	15.000A	170.000W	110J	.005E	15MA	40V	50 1.200A
2N2079	P	MOT.ETC.OEL.SOL.HUG	405	To 36	80	65	40.0	15.000A	170.000W	110J	.005E	15MA	80V	80 1.200A
2N2079A	P	MOT	405	To 36	80	65	40.0	15.000A	170.000W	110J	.005E	15MA	80V	80 1.200A
2N2080	P	MOT.ETC.OEL.SOL.HUG	405	To 36	70	55	35.0	15.000A	170.000W	110J	.005E	15MA	70V	80 1.200A
2N2080A	P	MOT	405	To 36	70	55	35.0	15.000A	170.000W	110J	.005E	15MA	70V	80 1.200A
2N2081	P	MOT.ETC.OEL.SOL.HUG	405	To 36	50	45	25.0	15.000A	170.000W	110J	.005E	15MA	50V	80 1.200A
2N2081A	P	MOT	405	To 36	50	45	25.0	15.000A	170.000W	110J	.005E	15MA	50V	80 1.200A
2N2082	P	MOT.ETC.OEL.SOL.HUG	405	To 36	40	25	20.0	15.000A	170.000W	110J	.005E	15MA	40V	80 1.200A
2N2082A	P	MOT	405	To 36	40	25	20.0	15.000A	170.000W	110J	.005E	15MA	40V	80 1.200A
2N2084	P	AMP	217	To 33	40	40	1.0	0.10A	.125W	80J	100.000E	8UA	6V	140
2N2086	P	AMP	211	To 5	120	80R	5.0	500A	.600W	175J	150.000G	2UA	60V	30 .150A
2N2089	P	AMP	75	To 7	20	20R	1.0	0.10A	.083W	75J	44.000G	8UA	6V	150
2N2090	P	AMP	75	To 7	20	20	1.0	0.10A	.083W	75J	44.000G	8UA	6V	150
2N2091	P	AMP	75	To 7	20	20	1.0	0.10A	.083W	75J	44.000G	8UA	6V	150
2N2092	P	AMP	75	To 7	25	25R	1.0	0.10A	.100W	85J	30.000G	8UA	6V	150
2N2093	P	AMP	75	To 7	25	25R	2.0	0.10A	.100W	85J	30.000G	8UA	6V	150
2N2095	P	SEE RF POWER SECTION	211	211P	25	25	4.0	.500A	.500W	100J	HS SW	12UA	12V	50 .200A
2N2096	P	MOT	211	211P	40	20	4.0	.500A	.500W	100J	150.000G	12UA	15V	50 .400A
2N2097	P	MOT	211	211P	40	20	4.0	.500A	.500W	100J	150.000G	12UA	15V	50 .400A
2N2098	P	SEE RF POWER SECTION	210	To 5	25	12	4.0	.500A	.300W	100J	HS SW	12UA	12V	35 .400A
2N2099	P	MOT	210	To 5	40	20	4.0	.500A	.300W	100J	HS SW	12UA	15V	50 .400A
2N2100	P	MOT	210	To 5	25	12	4.0	.500A	.300W	100J	HS SW	12UA	12V	35 .400A
2N2101	N	S BEN.AMF.ETC	561	To 61	200	150	10.0	3.000A	75.000W	200J	60.000G	30UA	1V	30 1.000A
2N2102	N	RAY.TII.TRW.TEC.HUG	211	To 5	120	65	7.0	1.000A	1.000W	200J	60.000G	2NA	60V	70 .150A
2N2102A	N	RAY.TII.HUG	211	To 5	120	65	7.0	1.000A	1.000W	200J	60.000G	2NA	60V	70 .150A
2N2106	N	S GEC.TEC.HUG	211	To 5	60	60	8.0	1.000W	1.50W	150J	15.000B	200UA	30V	30
2N2107	N	S GEC.TEC.HUG	211	To 5	60	60	8.0	1.000W	1.50W	150J	15.000B	200UA	30V	30
2N2108	N	S GEC.TEC.HUG	211	To 5	60	60	8.0	1.000W	1.50W	150J	15.000B	200UA	30V	30
2N2109	N	S WHE.SPC	502	502A	50	50	15.0	30.000A	250.000W	175J	.500G	30MA	50V	14 10.000A
2N2110	N	S WHE.SPC	502	502A	100	100	15.0	30.000A	250.000W	175J	.500G	30MA	100V	14 10.000A
2N2111	N	S WHE.SPC	502	502A	150	150	15.0	30.000A	250.000W	175J	.500G	30MA	150V	14 10.000A
2N2112	N	S WHE.SPC	502	502A	200	200	15.0	30.000A	250.000W	175J	.500G	30MA	200V	14 10.000A
2N2113	N	S WHE.SPC	502	502A	250	250	15.0	30.000A	250.000W	175J	.500G	30MA	250V	14 10.000A
2N2114	N	S WHE.SPC	502	502A	300	300	15.0	30.000A	250.000W	175J	.500G	30MA	300V	14 10.000A
2N2116	N	S WHE.SPC	502	502A	50	50	15.0	30.000A	250.000W	175J	.500G	30MA	50V	14 15.000A
2N2117	N	S WHE.SPC	502	502A	100	100	15.0	30.000A	250.000W	175J	.500G	30MA	100V	14 15.000A
2N2118	N	S WHE.SPC	502	502A	150	150	15.0	30.000A	250.000W	175J	.500G	30MA	150V	14 15.000A
2N2119	N	S WHE.SPC	502	502A	200	200	15.0	30.000A	250.000W	175J	.500G	30MA	200V	14 15.000A
2N2120	N	S WHE.SPC	502	502A	250	250	15.0	30.000A	250.000W	175J	.500G	30MA	250V	14 15.000A
2N2123	N	S WHE.SPC	502	502A	50	50	15.0	30.000A	250.000W	175J	.500G	30MA	50V	13 20.000A
2N2124	N	S WHE.SPC	502	502A	100	100	15.0	30.000A	250.000W	175J	.500G	30MA	100V	14 20.000A
2N2125	N	S WHE.SPC	502	502A	150	150	15.0	30.000A	250.000W	175J	.500G	30MA	150V	13 20.000A
2N2126	N	S WHE.SPC	502	502A	200	200	15.0	30.000A	250.000W	175J	.500G	30MA	200V	13 20.000A
2N2130	N	S WHE.SPC	502	502A	50	50	15.0	30.000A	250.000W	175J	.500G	30MA	50V	14 25.000A
2N2131	N	S WHE.SPC	502	502A	100	100	15.0	30.000A	250.000W	175J	.500G	30MA	100V	14 25.000A
2N2132	N	S WHE.SPC	502	502A	150	150	15.0	30.000A	250.000W	175J	.500G	30MA	150V	14 25.000A
2N2133	N	S WHE.SPC	502	502A	200	200	15.0	30.000A	250.000W	175J	.500G	30MA	200V	14 25.000A
2N2137	P	MOT.ETC	605	To 3	30	20	15.0	70.000W	110J	.020E	50UA	2V	22 2.000A	
2N2137A	P	MOT.ETC	605	To 3	30	20	15.0	70.000W	110J	.020E	50UA	2V	22 2.000A	
2N2138	P	MOT.ETC.HUG	605	To 3	45	30	25.0	70.000W	110J	.020E	50UA	2V	22 2.000A	
2N2138A	P	MOT.ETC	605	To 3	45	30	25.0	70.000W	110J	.020E	50UA	2V	22 2.000A	
2N2139	P	MOT.ETC.HUG	605	To 3	60	45	30.0	70.000W	110J	.020E	50UA	2V	22 2.000A	
2N2139A	P	MOT.ETC	605	To 3	60	45	30.0	70.000W	110J	.020E	50UA	2V	22 2.000A	
2N2140	P	MOT.ETC.HUG	605	To 3	75	60	40.0	70.000W	110J	.020E	50UA	2V	22 2.000A	
2N2140A	P	MOT.ETC	605	To 3	75	60	40.0	70.000W	110J	.020E	50UA	2V	22 2.000A	
2N2141	P	MOT.ETC.HUG	605	To 3	90	65	45.0	70.000W	110J	.020E	50UA	2V	22 2.000A	
2N2141A	P	MOT.ETC	605	To 3	90	65	45.0	70.000W	110J	.020E	50UA	2V	22 2.000A	
2N2142	P	MOT.ETC.HUG	605	To 3	30	20	15.0	70.000W	110J	.020E	50UA	2V	33 2.000A	
2N2142A	P	MOT.ETC	605	To 3	30	20	15.0	70.000W	110J	.020E	50UA	2V	33 2.000A	
2N2143	P	MOT.ETC.HUG	605	To 3	45	30	25.0	70.000W	110J	.020E	50UA	2V	33 2.000A	
2N2143A	P	MOT.ETC	605	To 3	45	30	25.0	70.000W	110J	.020E	50UA	2V	33 2.000A	
2N2144	P	MOT.ETC.HUG	605	To 3	60	45	30.0	70.000W	110J	.020E	50UA	2V	33 2.000A	
2N2144A	P	MOT.ETC	605	To 3	60	45	30.0	70.000W	110J	.020E	50UA	2V	33 2.000A	
2N2145	P	MOT.ETC.HUG	605	To 3	75	60	40.0	70.000W	110J	.020E	50UA	2V	33 2.000A	
2N2145A	P	MOT.ETC	605	To 3	75	60	40.0	70.000W	110J	.020E	50UA	2V	33 2.000A	
2N2146	P	MOT.ETC.HUG	605	To 3	90	65	45.0	70.000W	110J	.020E	50UA	2V	33 2.000A	
2N2146A	P	MOT.ETC	605	To 3	90	65	45.0	70.000W	110J	.020E	50UA	2V	33 2.000A	
2N2147	P	RCA.ETC	605	To 3	75	50	1.5	5.000A	12.500W	100J	4.000G	1MA	40V	150 1.000A
2N2148	P	RCA.ETC	605	To 3	75	50	1.5	5.000A	12.500W	100J	3.000G	1MA	40V	100 1.000A
2N2150	N	S TII.TEC.HUG	581	To 11	125	80R	8.0	2.000A	30.000W	175J	10.000G	10UA	120V	40 .500A
2N2151	N	S TII.TEC.HUG	581	To 11	125	80R	8.0	2.000A	30.000W	175J	10.000G	10UA	120V	80
2N2152	P	MOT.ETC.SOL	405	To 36	45	30	25.0	30.000A	170.000W	110J	.002E	4MA	45V	76 5.000A
2N2152A	P	MOT.ETC	405	To 36	45	30	25.0	30.000A	170.000W	110J	.002E	4MA	45V	76 5.000A
2N2153	P	MOT.ETC.SOL	405	To 36	60	45	30.0	30.000A	170.000W	110J	.002E	4MA	60V	76 5.000A
2N2153A	P	MOT.ETC	405	To 36	60	45	30.0	30.000A	170.000W	110J	.002E	4MA	60V	76 5.000A
2N2154	P	MOT.ETC.SOL	405	To 36	75	60	40.0	30.000A	170.000W	110J	.002E	4MA	75V	76 5.000A
2N2154A	P	MOT.ETC	405	To 36	75	60	40.0	30.000A	170.000W	110J	.002E	4MA	75V	76 5.000A
2N2155	P	MOT.ETC	405	To 36	75	60	40.0	30.000A	170.000W	110J	.002E	4MA	75V	76 5.000A
2N2155A	P	MOT.ETC	405	To 36	75	60	40.0	30.000A	170.000W	110J	.002E	4MA	75V	76 5.000A
2N2156	P	MOT.ETC	405	To 36	75	60	40.0	30.000A	170.000W	110J	.002E	4MA	75V	76 5.000A
2N2156A	P	MOT.ETC.SOL	405	To 36	45	30	25.0	30.000A	170.000W	110J	.002E	4MA	45V	106 5.000A
2N2157	P	MOT.ETC	405	To 36	45	30	25.0	30.000A	170.000W	110J	.002E	4MA	45V	106 5.000A
2N2157A	P	MOT.ETC	405	To 36	60	45	30.0	30.000A	170.000W	110J	.002E	4MA	60V	106 5.000A
2N2158	P	MOT.ETC.SOL.HUG	405	To 36	75	60	40.0	30.000A	170.000W	110J	.002E	4MA	75V	106 5.000A
2N2158A	P	MOT.ETC	405	To 36	75	60	40.0	30.000A						

Transistor Type No	N P	G S	Manufacturer	Lead Ident	Out line	Maximum (V)		Maximum		Max T (°C)	Frequency Resp (MHz)	Leakage		Gain	
						V _{CE}	V _{BE}	I _C	Power			I _{CE0}	V _{CE0}		I _{BE0}
2N2189	P	C	TI	120	To 58	40	25	2.0		.125W	85J	100.00G	3UA	12V	120
2N2190	P	C	TI	120	To 58	60	25	2.0		.125W	85J	60.00G	3UA	12V	100
2N2191	P	C	TI	120	To 58	60	25	2.0		.125W	85J	100.00G	3UA	12V	120
2N2192	N	S	RAY, TI, MOT, GIC, SES, NSC	211	To 5	60	40	5.0	1.000A	.800W	200J	50.00G	10NA	30V	200
2N2192A	N	S	GEC, RAY, TI, MOT, GIC, ITT	211	To 5	60	40	5.0	1.000A	.800W	200J	50.00G	10NA	30V	200
2N2192B	N	S	RAY, MOT, GIC, ITT, TEC, HUG	211	To 5	60	40	5.0	1.000A	.800W	200J	50.00G	10NA	30V	200
2N2193	N	S	RAY, ITT, SES, TI, MOT, SES	211	To 5	60	40	5.0	1.000A	.800W	200J	50.00G	10NA	30V	200
2N2193A	N	S	RAY, TI, MOT, ITT, SES, NSC	211	To 5	60	40	5.0	1.000A	.800W	200J	50.00G	10NA	30V	200
2N2193B	N	S	RAY, ITT, MOT, TEC, HUG	211	To 5	60	40	5.0	1.000A	.800W	200J	50.00G	10NA	30V	200
2N2194	N	S	RAY, TI, MOT, ITT, SES, NSC	211	To 5	60	40	5.0	1.000A	.800W	200J	50.00G	10NA	30V	200
2N2194A	N	S	RAY, TI, MOT, ITT, SES, NSC	211	To 5	60	40	5.0	1.000A	.800W	200J	50.00G	10NA	30V	200
2N2194B	N	S	RAY, MOT, ITT, TEC, HUG	211	To 5	60	40	5.0	1.000A	.800W	200J	50.00G	10NA	30V	200
2N2195	N	S	GEC, RAY, MOT, ITT, SES, NSC	211	To 5	45	25	5.0	1.000A	.800W	200J	50.00G	10NA	30V	40
2N2195A	N	S	GEC, RAY, MOT, ITT, SES, NSC	211	To 5	45	25	5.0	1.000A	.800W	200J	50.00G	10NA	30V	40
2N2195B	N	S	RAY, MOT, ITT, TEC, HUG	211	To 5	45	25	5.0	1.000A	.800W	200J	50.00G	10NA	30V	40
2N2196	N	S	GEC, SES, TEC, HUG	635	635B	80	60	8.0	15.000W	175J	15.000W	75UA	80V	20	200
2N2197	N	S	GEC, SES, TEC, HUG	170	To 9	15	10	.5	100A	.075W	100J	15.000W	75UA	80V	40
2N2199	P	G	ETC	170	To 9	15	10	.5	100A	.075W	100J	120.00G	5UA	10V	14
2N2200	N	S	GEC, TEC, HUG	635	635B	120	100	10.0	15.000W	175J	20.000W	50UA	120V	60	40.03A
2N2201	N	S	GEC, HUG	670	670A	120	100	10.0	15.000W	175J	20.000W	50UA	120V	60	40.03A
2N2202	N	S	GEC, HUG	676	676A	120	100	10.0	15.000W	175J	20.000W	50UA	120V	60	40.03A
2N2203	N	S	GEC, HUG	680	680A	120	100	10.0	15.000W	175J	20.000W	50UA	120V	60	40.03A
2N2204	N	S	RAY, FSC	211	To 18	25	12R	3.0	.200A	.300W	175J	200.00G	25NA	15V	40
2N2205	N	S	RAY, FSC	211	To 46	25	12	3.0	.200A	.300W	175J	200.00G	25NA	15V	70
2N2206	N	S	AMP	75	To 7	50	50R	5.0	.030A	.300W	100J	140.00G	03SE		200
2N2210	P	G	ETC	405	To 36	100	65	6.0	10.000A	75.000W	75J	30.000W	4MA	100V	3
2N2212	P	G	BEN, MOT	607	To 41	120	60	1.5	10.000A	60.000W	110J	1.500W	2MA	100V	80
2N2217	N	S	FSC, RAY, SPR, TI, SES, ITT	211	To 5	60	30	5.0	800A	.800W	175J	250.00G	10NA	50V	40
2N2217/51	N	S	SVL	909	To 51	60	30	5.0	800A	.800W	175J	250.00G	10NA	50V	30
2N2218	N	S	FSC, RAY, SPR, SES, ITT, MOT	211	To 5	60	30	5.0	800A	.800W	175J	250.00G	10NA	50V	30
2N2218/51	N	S	SVL	909	To 51	60	30	5.0	800A	.800W	175J	250.00G	10NA	50V	30
2N2218A	N	S	RAY, FSC, MOT, GEC, TRW, ITT	211	To 5	75	40	6.0	800A	.800W	175J	250.00G	10NA	60V	70
2N2219	N	S	RAY, FSC, MOT, GEC, TRW, ITT	211	To 5	60	30	5.0	800A	.800W	175J	250.00G	10NA	50V	200
2N2219/51	N	S	SVL	909	To 51	60	30	5.0	800A	.800W	175J	250.00G	10NA	50V	200
2N2219A	N	S	RAY, FSC, MOT, GEC, TRW, ITT	211	To 5	75	40	6.0	800A	.800W	175J	250.00G	10NA	50V	90
2N2220	N	S	FSC, RAY, TI, ITT, SES, GEC	211	To 18	60	30	5.0	800A	.500W	175J	250.00G	10NA	60V	150
2N2221	N	S	GEC, RAY, TI, ITT, SES, SPR	211	To 18	60	30	5.0	800A	.500W	175J	250.00G	10NA	50V	80
2N2221A	N	S	GEC, MOT, FSC, RAY, TRW, ITT	211	To 18	75	40	6.0	800A	.500W	175J	250.00G	10NA	50V	80
2N2222	N	S	FSC, RAY, TI, SES, GIC, MOT	211	To 18	60	30	5.0	800A	.500W	175J	250.00G	10NA	60V	80
2N2222A	N	S	GEC, MOT, FSC, RAY, TRW, ITT	211	To 18	75	40	6.0	800A	.500W	175J	250.00G	10NA	50V	200
2N2224	N	S	MOT	211	To 5	65	40	5.0	500A	.800W	175J	160.00G	10UA	50V	65
2N2226	N	S	WHE, SPC, HUG	412	To 82	50	50	15.0	10.000A	150.000W	150J	.500G	200UA	50V	360
2N2227	N	S	WHE, SPC, HUG	412	To 82	100	100	15.0	10.000A	150.000W	150J	.500G	200UA	100V	360
2N2228	N	S	WHE, SPC, HUG	412	To 82	150	150	15.0	10.000A	150.000W	150J	.500G	200UA	150V	360
2N2229	N	S	WHE, SPC, HUG	412	To 82	200	200	15.0	10.000A	150.000W	150J	.500G	200UA	200V	360
2N2230	N	S	WHE, SPC, HUG	412	To 82	50	50	15.0	10.000A	150.000W	150J	.500G	200UA	50V	100.000A
2N2231	N	S	WHE, SPC, HUG	412	To 82	100	100	15.0	10.000A	150.000W	150J	.500G	200UA	100V	100.000A
2N2232	N	S	WHE, SPC, HUG	412	To 82	150	150	15.0	10.000A	150.000W	150J	.500G	200UA	150V	100.000A
2N2233	N	S	WHE, SPC, HUG	412	To 82	200	200	15.0	10.000A	150.000W	150J	.500G	200UA	200V	100.000A
2N2236	N	S	RAY	211	To 5	40	20	6.0	.500A	.600W	200J	50.000G	20NA	40V	50
2N2237	N	S	MOT	211	To 5	40	20	6.0	.500A	.600W	200J	50.000G	20NA	40V	72
2N2242	N	S	GEC, SES, RAY, TI, NSC, TEC	211	To 5	120	80	7.0	1.000A	.800W	200J	50.000G	10NA	60V	80
2N2243	N	S	GEC, SES, RAY, TI, NSC, TEC	211	To 5	120	80	7.0	1.000A	.800W	200J	50.000G	10NA	60V	80
2N2243A	N	S	NSC	210	To 18	30	20	6.0	100A	.500W	200J	60.000G	10NA	30V	80
2N2244	N	S	NSC	210	To 18	30	20	6.0	100A	.500W	200J	60.000G	10NA	30V	160
2N2245	N	S	NSC	210	To 18	60	45	6.0	100A	.500W	200J	60.000G	10NA	30V	300
2N2246	N	S	NSC	210	To 18	60	45	6.0	100A	.500W	200J	60.000G	10NA	60V	160
2N2247	N	S	NSC	210	To 18	60	45	6.3	100A	.500W	200J	600.000G	10NA	60V	160
2N2248	N	S	NSC	210	To 18	30	20	6.0	.500W	200J	60.000G	10NA	30V	80	
2N2249	N	S	NSC	210	To 18	30	20	6.0	.500W	200J	60.000G	10NA	30V	160	
2N2250	N	S	NSC	210	To 18	30	20	6.0	.500W	200J	60.000G	10NA	30V	80	
2N2251	N	S	NSC	210	To 18	30	20	6.0	.500W	200J	60.000G	10NA	30V	160	
2N2252	N	S	NSC	210	To 18	30	20	6.0	.500W	200J	60.000G	10NA	30V	80	
2N2253	N	S	NSC	210	To 18	60	45	6.0	.500W	200J	60.000G	10NA	60V	80	
2N2254	N	S	NSC	210	To 18	60	45	6.0	.500W	200J	60.000G	10NA	60V	160	
2N2255	N	S	NSC	210	To 18	60	45	6.0	.500W	200J	60.000G	10NA	60V	160	
2N2256	N	S	MOT	210	To 18	60	45	6.0	.500W	200J	60.000G	10NA	60V	300	
2N2257	N	S	MOT	210	To 18	7	7	1.0	.100A	.100W	100J	250.000G	10UA	6V	30
2N2258	P	G	SOL, HUG	427	To 10	100	55	28.0	5.000A	50.000W	125J	.200G	2MA	100V	44
2N2259	P	G	SOL, HUG	427	To 10	120	55	28.0	5.000A	50.000W	125J	.200G	2MA	100V	44
2N2260	P	G	SOL, HUG	426	To 10	100	55	28.0	5.000A	50.000W	125J	.200G	2MA	100V	44
2N2261	P	G	HUG	426	To 10	120	55	28.0	5.000A	50.000W	125J	.200G	2MA	100V	44
2N2270	N	S	RCA, ETC, RAY, NSC, TI, TEC	210	To 5	20	15	10.0	.500A	.250W	100J	1.010E	10UA	10V	90
2N2271	P	G	ETC	210	To 5	20	15	10.0	.500A	.250W	100J	1.010E	10UA	10V	90
2N2272	P	G	MOT	211	To 18	25	15	1.0	100A	.100W	100J	90.000G	10UA	10V	75
2N2273	P	S	SPR, HUG	210	To 18	25	15	25.0	.050A	.150W	200J	6.000G	3NA	10V	16
2N2274	P	S	M.P. 2N2274	210	To 18	15	10	15.0	.050A	.150W	140J	6.000G	3NA	10V	16
2N2275	P	S	M.P. 2N2275	210	To 18	15	10	15.0	.050A	.150W	140J	6.000G	3NA	10V	16
2N2277	P	S	M.P. 2N2277	210	To 18	15	10	15.0	.050A	.150W	140J	6.000G	3NA	10V	16
2N2278	P	S	M.P. 2N2278	210	To 18	15	10	15.0	.050A	.150W	140J	6.000G	3NA	10V	16
2N2280	P	S	M.P. 2N2280	210	To 18	10	6	10.0	.050A	.150W	140J	16.000G	3NA	6V	16
2N2281	P	G	BEN	631	To 37	60	30		3.000A	5.000W	110J	2.500B	100UA	20V	60
2N2282	P	G	BEN	631	To 37	100	60		3.000A	5.000W	110J	2.500B	100UA	40V	60
2N2283	P	G	BEN	631	To 37	200	100		3.000A	5.000W	110J	2.500B	100UA	60V	60
2N2284	P	G	BEN, ETC, MOT	605	To 3	100	60	1.5	25.000A	100.000W	110J	.010E	5MA	40V	40
2N2285	P	G	BEN, ETC, MOT	605	To 3	100	60	1.5	25.000A	100.000W	110J	.010E	5MA	40V	40
2N2286	P	G	BEN, ETC, MOT	605	To 3	120	80	1.5	25.000A	100.000W	110J	.010E	5MA	40V	40
2N2287															

Transistor Type No.	N P S	G S	Manufacturer	Lead Ident	Out- line	Maximum (V)			Maximum Power	Max. T _c (°C)	Frequency Resp.(MHz)	Leakage I _{cs} @ V _{cs}	h _{FE} @ I _c		
						V _{ce}	V _{ce}	V _{ce}					I _c	I _c	
2N2311	N	S	RAY, TRW	211	To 46	100	100	8.0	.350W	175J	50.000G	25NA 100V	24	.200A	
2N2312	N	S	RAY, TRW, HUG	211	To 46	60	60	8.0	35.0W	175J	40.000G	25NA 60V	60	.200A	
2N2313	N	S	RAY, TRW, HUG	211	To 46	100	100	8.0	35.0W	175J	40.000G	25NA 100V	60	.200A	
2N2314	N	S	RAY, TRW, HUG	211	To 46	60	40	5.0	35.0W	175J	40.000G	25NA 30V	40	.150A	
2N2315	N	S	RAY, TRW, HUG	211	To 46	60	40	5.0	35.0W	175J	40.000G	25NA 30V	80	.150A	
2N2316	N	S	RAY, TRW, HUG	211	To 46	120	80	5.0	35.0W	175J	50.000G	10NA 60V	80	.150A	
2N2317	N	S	RAY, TRW, HUG	211	To 46	75	50	5.0	36.0W	200J	300.000G	50NA 20V	60	.010A	
2N2318	N	S	RAY, TRW, HUG	210	To 18	30	15	30.0	3.00W	200J	300.000G	50NA 20V	60	.010A	
2N2319	N	S	GIC	210	To 18	30	15	5.0	6.00W	200J	300.000G	50NA 20V	60	.010A	
2N2320	N	S	GIC	210	To 5	30	15	5.0	8.00W	200J	300.000G	50NA 20V	100	.010A	
2N2330	N	S	MOT, HUG	210	To 5	30	20	5.0	8.00W	175J	150.000G	1NA 5V	100	.010A	
2N2331	N	S	MOT, ETC, HUG	210	To 18	15	5	15.0	.150W	175J	15.000G	50NA 15V			
2N2332	N	S	SOL, HUG	210	To 18	15	5	15.0	.150W	175J	15.000G	50NA 15V			
2N2333	P	S	SOL, HUG	210	To 18	30	15	30.0	.150W	175J	15.000G	50NA 30V			
2N2334	P	S	SOL, HUG	210	To 18	30	15	30.0	.150W	175J	15.000G	100NA 50V			
2N2335	P	S	SOL, HUG	210	To 18	30	15	30.0	.150W	175J	15.000G	100NA 50V			
2N2336	P	S	SOL, HUG	210	To 18	50	35	50.0	.150W	175J	15.000G	100NA 50V			
2N2337	P	S	SOL, HUG	405	To 36	60	40	6.0	7.500A	150.000W	200J	200NA 30V	3E	-.300A	
2N2338	N	S	RC	461	To 57	60	40	6.0	2.500A	40.000W	200J	100UA 30V	18H	.010A	
2N2339	N	S	ETA	210	To 5	40	15			2.500W		1UA 12V	18H	.010A	
2N2349	N	S	TRW, GEC, HUG	211	To 46	60	40	5.0	1.000A	.400W	200J	50.000G	10NA 30V	20H	.150A
2N2350	N	S	RAY, TRW, ITT, HUG	211	To 46	60	40	5.0	1.000A	.400W	200J	50.000G	10NA 30V	20H	.150A
2N2351	N	S	GEC, RAY, TRW, ITT, HUG	211	To 46	60	40	5.0	1.000A	.400W	200J	50.000G	10NA 30V	20H	.150A
2N2351A	N	S	RAY, TRW, ITT, HUG	211	To 46	80	50	8.0	1.000A	.400W	200J	50.000G	10NA 60V	80	.150A
2N2352	N	S	RAY, TRW, ITT, FSC, HUG	211	To 46	60	40	5.0	1.000A	.400W	200J	50.000G	10NA 30V	40	.150A
2N2352A	N	S	RAY, TRW, ITT, FSC, HUG	211	To 46	60	40	5.0	1.000A	.400W	200J	50.000G	10NA 30V	40	.150A
2N2353	N	S	GEC, RAY, TRW, ITT, FSC, HUG	211	To 46	45	25	5.0	1.000A	.350W	200J	50.000G	100NA 30V	40	.150A
2N2353A	N	S	GEC, RAY, TRW, ITT, FSC, HUG	211	To 46	45	25	5.0	1.000A	.350W	200J	50.000G	100NA 30V	40	.150A
2N2357	P	G	BEN, MOT	607	To 41	100	60	2.5	50.000A	170.000W	110J	.010E	5MA 40V	60	
2N2358	P	G	BEN, MOT	607	To 41	120	80	2.5	50.000A	170.000W	110J	.010E	5MA 40V	60	
2N2359	P	G	SPR, HUG	217	To 12	20	20S	.5	.050A	.060W	125J	980.000G	10UA 10V	32	
2N2360	P	G	SPR, HUG	217	To 12	20	20S	.5	.050A	.060W	100J	980.000G	10UA 10V	32	
2N2361	P	G	SPR, HUG	217	To 12	20	20S	.5	.050A	.060W	100J	980.000G	10UA 10V	32	
2N2362	P	G	SPR, HUG	217	To 12	20	20S	.5	.050A	.060W	100J	980.000G	10UA 10V	32	
2N2363	P	G	SPR, HUG	217	To 12	20	20S	.5	.050A	.060W	100J	980.000G	10UA 10V	32	
2N2364	N	S	RAY, TRW, GEC, HUG	211	To 46	120	80	7.0	4.00W	200J	5.000G	10NA 60V	80	.150A	
2N2364A	N	S	RAY, TRW, GEC, HUG	211	To 46	120	80	7.0	4.00W	200J	5.000G	10NA 60V	80	.150A	
2N2368	N	S	FSC, RAY, TII, SES, ITT, MOT	211	To 18	40	15	4.5	5.00A	.360W	200J	500.000G	400NA 20V	80	.010A
2N2369	N	S	FSC, RAY, TII, SES, ITT, MOT	211	To 18	40	15	4.5	5.00A	.360W	200J	500.000G	400NA 20V	80	.010A
2N2369A	N	S	FSC, RCA, RAY, TII, ITT, NSC	211	To 18	40	15	4.5	2.00A	.360W	200J	500.000G	400NA 20V	80	.100A
2N2370	P	S	HUG	210	To 5	15	15	15.0	1.00A	.200W	200A	5NA 15V	15		
2N2371	P	S	HUG	210	To 5	15	15	15.0	1.00A	.200W	200A	5NA 15V	15		
2N2372	P	S	HUG	210	To 5	15	15	15.0	1.00A	.200W	200A	5NA 15V	15		
2N2373	P	S	HUG	210	To 5	15	15	15.0	1.00A	.200W	200A	5NA 15V	175	.100A	
2N2374	P	G	ETC	210	To 5	35	35S	35.0	5.00A	.250W	100J	15.000B	7UA 15V	75	.100A
2N2375	P	G	ETC	210	To 5	35	35S	35.0	5.00A	.250W	100J	9.000B	7UA 15V	75	.100A
2N2376	N	S	M.P. 2N2375	210	To 18	25	25		.050A	.150W	140J	8.000G	1UA 25V	26	.005A
2N2377	P	S	SPR, HUG	210	To 18	10	10	10.0	.050A	.150W	140J	7.200G	100NA 10V	26	
2N2378	P	S	SPR, HUG	211	To 5	80	40	5.0	5.00A	.600W	200J	100.000G	200NA 50V	70	.150A
2N2380	N	S	RAY	210	To 5	80	40	5.0	5.00A	.600W	200J	100.000G	200NA 50V	70	.150A
2N2380A	N	S	RAY	210	To 5	80	40	5.0	5.00A	.600W	200J	100.000G	200NA 50V	70	.150A
2N2381	P	G	MOT	211	To 5	30	15	4.0	5.00A	.300W	100J	300.000G	15UA 15V	50	.400A
2N2382	P	G	MOT	211	To 5	30	15	4.0	5.00A	.300W	100J	300.000G	15UA 15V	50	.400A
2N2383	N	S	GEC, TII	909	To 50	45	45	5.0	.030A	.300W	175J	30.000G	10NA 45V	60	.001A
2N2388	N	S	GEC, TII	909	To 50	45	45	5.0	.030A	.300W	175J	30.000G	10NA 45V	200	.001A
2N2389	N	S	TII	909	To 50	75	50R	7.0	.500A	.450W	200J	60.000G	10NA 60V	100	
2N2390	N	S	TII	909	To 50	75	50R	7.0	.500A	.450W	200J	60.000G	10NA 60V	100	
2N2390A	N	S	TII	909	To 50	50	35	5.0	3.00A	.450W	175J	50.000G	1UA 30V	30	
2N2393	N	S	TII	909	To 50	50	35	5.0	3.00A	.450W	175J	60.000G	1UA 30V	30	
2N2394	N	S	TII	909	To 50	60	40	5.0	3.00A	.450W	175J	60.000G	10NA 30V	30	
2N2395	N	S	TII, GEC	909	To 50	60	40	5.0	3.00A	.450W	175J	60.000G	10NA 30V	30	
2N2396	N	S	TII, GEC	909	To 50	60	40	5.0	3.00A	.450W	175J	60.000G	10NA 30V	30	
2N2399	N	S	SPR, HUG	217	To 12	20	20S	.5	.050A	.060W	100J	900.000G	10UA 10V	32	
2N2399A	N	S	SPR, HUG	217	To 12	20	20S	.5	.050A	.060W	100J	900.000G	10UA 10V	32	
2N2400	N	S	SPR, HUG	210	To 18	12	7	1.0	1.00A	.150W	100J	200.000G	2UA 5V	100	
2N2401	N	S	SPR, HUG	210	To 18	12	7	1.0	1.00A	.150W	100J	200.000G	2UA 5V	100	
2N2402	N	S	TRW, RCA, RAY, MOT, HUG	211	To 5	120	90	7.0	2.000W		40.000G	10NA 90V	110	.150A	
2N2410	N	S	TII, MOT, SES, RAY, TEC, HUG	211	To 5	60	30	5.0	.800A	.800W	200J	20.000G	300NA 30V	75	.150A
2N2411	N	S	SYL	909	To 51	60	30	5.0	.800A	.800W	200J	20.000G	300NA 30V	75	.150A
2N2412	N	S	TII, TEC, HUG	211	To 18	25	20	5.0	1.00A	.300W	200J	140.000G	10NA 25V	40	
2N2413	N	S	TII, TEC, HUG	211	To 18	25	20	5.0	1.00A	.300W	200J	140.000G	10NA 25V	80	
2N2415	N	S	TII, MOT	217	To 72	15	10	.3	.020A	.075W	100J	400.000G	5UA 10V	50	
2N2416	P	G	TII, MOT	217	To 72	15	10	.3	.020A	.075W	100J	400.000G	5UA 10V	50	
2N2423	N	S	BEN	605	To 3	100	60	30.0	5.000A	90.000W	100J	.004E	5MA 100V	46	2.000A
2N2427	N	S	TEC, HUG	211	To 18	40	40	4.0	.050A	.500W	200A	50.000G	500NA 40V	35	.001A
2N2428	N	S	RAMP	120	To 1	32	12	1.0	1.00A	.165W	75J	1.300G	10UA 10V	130	
2N2429	N	S	RAMP	120	To 1	32	32S	10.0	1.00A	.165W	75J	1.700G	10UA 10V	140	
2N2430	N	S	RAMP	120	To 1	32	32S	10.0	1.00A	.165W	75J	1.500G	15UA 10V	120	
2N2431	N	S	RAMP	120	To 1	32	32	10.0	1.000A	.165W	100J	1.000G	10UA 10V	90	
2N2432	N	S	TII, NSC, TEC, HUG	211	To 18	30	30	15.0	1.00A	.300W	175J	20.000G	10NA 25V	80	
2N2432A	N	S	TII, TEC, HUG	211	To 18	45	45	18.0	1.00A	.300W	175J	20.000G	10NA 40V	100	.001A
2N2433	N	S	TRW	211	To 46	75	45	7.0	2.000W		90.000G	1NA 60V	170	.150A	
2N2434	N	S	TRW	211	To 46	120	80	7.0	2.000W		90.000G	1NA 90V	170	.150A	
2N2435	N	S	TRW	211	To 46	120	80	7.0	2.000W		90.000G	1NA 90V	170	.150A	
2N2436	N	S	TRW	211	To 46	120	80	7.0	2.000W		90.000G	1NA 90V	170	.150A	
2N2437	N	S	TRW	211	To 46	100	75	7.0	2.000W		90.000G	1NA 75V	170	.150A	
2N2438	N	S	TRW	211	To 46	100	75	7.0	2.000W		90.000G	1NA 75V	170	.150A	
2N2439	N	S	TRW	211	To 46	100	75	7.0	2.000W		90.000G	1NA 75V	170	.150A	
2N2440	N	S	TRW, HUG	211	To 5	120	80	7.0	3.000W		90.000G	1			

Transistor Type No.	N P S	Manufacturer	Lead Ident	Out- line	Maximum (V)			Maximum		Max. T.C.	Frequency Resp.(MHz)	Leakage		Gain h _{FE} @ I _C
					V _{CE}	V _{BE}	V _{ES}	I _C	Power			I _{ES} @ V _{CE}	I _{CS} @ I _C	
2N2467	P	GEN	211	To 5	60	30		3.000A	5.000W	110J	2.500B	100UA	20V	60
2N2468	P	GEN	211	To 5	100	60		3.000A	5.000W	110J	2.500B	100UA	40V	60
2N2469	P	GEN	211	To 5	200	100		3.000A	5.000W	110J	2.500B	150UA	60V	60
2N2475	N	RCA,TEC,FSC,HUG	211	To 18	15	6	4.0		.300W	200J	600.000G	50NA	5V	70
2N2475/46	N	SYL	210	To 46	15	6	4.0		.300W	200J	600.000G	50NA	5V	70
2N2475/51	N	SYL	909	To 51	60	6	4.0		.300W	200J	600.000G	50NA	5V	70
2N2476	N	RCA,SPR,RAY,MOT,HUG	210	To 5	60	20	5.0		.600W	200A	250.000G	200NA	30V	20
2N2477	N	RCA,SPR,RAY,MOT,HUG	210	To 5	60	20	5.0		.600W	200A	250.000G	200NA	30V	20
2N2478	N	PHL	211	To 5	120	40	5.0	.500A	.600W	175J	275.000G	200NA	30V	40
2N2479	N	RAY,SOL	211	To 18	20	15	5.0	.500A	.360W	100J	300.000G	50NA	20V	70
2N2481	N	ITT,RAY,MOT,TII,FSC,HUG	211	To 5	80	40	5.0	.500A	.600W	200J	150.000G	1NA	50V	60
2N2482	N	RCA	211	To 18	40	15	5.0	.500A	.360W	100J	300.000G	50NA	20V	70
2N2483	N	FSC,RAY,GEC,GIC,TII,SES	211	To 18	60	60	6.0	.500A	.360W	200J	600.000G	1NA	6V	100
2N2484	N	FSC,RAY,GEC,TII,SES,AEI	211	To 18	60	60	6.0	.500A	.360W	200J	600.000G	10NA	45V	100
2N2484A	N	RAY,SOL	211	To 18	60	60	6.0	.500A	.360W	200J	600.000G	10NA	45V	100
2N2487	P	SPR,HUG	210	To 18	15	10	6.0		.100A	.060W	100J	360.000G	3UA	40
2N2488	P	SPR,HUG	210	To 18	15	10	6.0		.100A	.060W	100J	360.000G	3UA	40
2N2489	P	SPR,HUG	210	To 18	15	10	6.0		.100A	.060W	100J	360.000G	3UA	40
2N2490	P	DEL,MOT,SOL	405	To 36	70	50	40.0	15.000A	85.000W	110J	.005E	200UA	2V	30
2N2491	P	DEL,MOT,ETC,SOL	405	To 36	60	40	30.0	15.000A	85.000W	110J	.005E	3MA	60V	50
2N2492	P	DEL,MOT,ETC,SOL	405	To 36	80	65	40.0	15.000A	85.000W	110J	.005E	2MA	80V	36
2N2493	P	DEL,MOT,ETC	405	To 36	100	75	80.0	15.000A	85.000W	110J	.005E	3MA	120V	36
2N2495	P	GAMP	217	To 33	35	35	.5	.010A	.100W	85J	135.000G	5NA	12V	60
2N2496	P	GAMP	218	To 72	35	40	.5	.010A	.100W	85J	135.000G	5NA	12V	60
2N2501	N	GIC,TEC,MOT	211	To 18	40	20	6.0		.360W	200J	350.000G	25NA	20V	86
2N2509	N	AMC,GIC,ITT,RAY,NSC,TEC	211	To 18	125	80	8.0		.360W	200J	45.000G	5NA	100V	80
2N2510	N	AMC,GIC,ITT,RAY,NSC,TEC	211	To 18	100	65	7.0		.360W	200J	45.000G	5NA	100V	80
2N2511	N	AMC,GIC,ITT,RAY,NSC,TEC	211	To 18	80	50	7.0		.360W	200J	45.000G	5NA	60V	100
2N2512	N	AMC,GIC,ITT,RAY,NSC,TEC	211	To 33	70	70S	6.0	.050A	.260W	75J	125.000G	5UA	1V	200
2N2514	N	SOL	210	To 46	80	60	6.0	.100A	.400W	200J	30.000G	5NA	50V	28
2N2515	N	SSD,SOL,HUG	210	To 46	80	60	8.0		.400W	200J	200.000G	5NA	50V	60
2N2516	N	SSD,SOL,HUG	210	To 46	80	60	8.0		.400W	200J	200.000G	5NA	50V	60
2N2517	N	SSD,SOL,HUG	211	To 46	125	80	8.0	.050A	.400W	200J	175.000G	5NA	80V	27
2N2518	N	SSD,SOL,HUG	210	To 46	125	80	8.0		.400W	200J	175.000G	5NA	80V	27
2N2519	N	SSD,SOL,HUG	210	To 46	125	80	8.0		.400W	200J	175.000G	5NA	80V	27
2N2520	N	SSD,SOL,HUG	211	To 46	60	60	8.0	.100A	.400W	200J	200.000G	5NA	50V	120
2N2521	N	SSD,SOL,HUG	210	To 46	60	60	8.0		.400W	200J	175.000G	5NA	45V	58
2N2522	N	SSD,SOL,HUG	210	To 46	60	60	8.0		.400W	200J	175.000G	5NA	45V	58
2N2523	N	SSD,SOL,HUG	210	To 46	60	60	8.0		.400W	200J	175.000G	5NA	45V	58
2N2524	N	SSD,SOL,HUG	210	To 46	60	60	8.0		.400W	200J	175.000G	5NA	45V	58
2N2525	N	SSD,SOL,HUG	210	To 46	60	60	8.0		.400W	200J	175.000G	5NA	45V	58
2N2526	N	TRW	561	To 61	100	80	5.0	1.000A	19.000W	100J	35.000G	2NA	45V	175
2N2527	P	MOT	605	To 3	80	80	5.0	10.000A	85.000W	110J	.010E	3MA	80V	36
2N2528	P	MOT	605	To 3	120	120	5.0	10.000A	85.000W	110J	.010E	3MA	120V	36
2N2529	N	ITT	210	To 18	45	40	2.0	.025A	.150W	175J	12.000B	50NA	30V	24
2N2530	N	ITT	210	To 18	45	40	2.0	.025A	.150W	175J	12.000B	50NA	30V	24
2N2531	N	ITT	210	To 18	45	40	2.0	.025A	.150W	175J	12.000B	50NA	30V	24
2N2532	N	ITT	210	To 18	45	40	2.0	.025A	.150W	175J	12.000B	50NA	30V	24
2N2533	N	ITT	210	To 18	45	40	2.0	.025A	.150W	175J	12.000B	50NA	30V	24
2N2534	N	ITT	210	To 18	45	40	2.0	.025A	.150W	175J	12.000B	50NA	30V	24
2N2537	N	ITT,TRW,GEC,SPR,MOT,TEC	211	To 5	60	30	5.0	.800A	.800W	200J	250.000G	250NA	40V	100
2N2538	N	ITT,TRW,GEC,SPR,MOT,TEC	211	To 5	60	30	5.0	.800A	.800W	200J	250.000G	250NA	40V	100
2N2539	N	ITT,TRW,GEC,SPR,MOT,TEC	211	To 18	60	30	5.0	.800A	.800W	200J	250.000G	250NA	40V	100
2N2540	N	ITT,TRW,GEC,SPR,MOT,TEC	211	To 18	60	30	5.0	.800A	.800W	200J	250.000G	250NA	40V	100
2N2551	N	SOL	210	To 5	150	150	15.0		.400W	200J	800B	100NA	10V	26
2N2552	P	GEN,TII,MOT	541	To 46	100	60	7.0	3.000A	20.000W	100J	225G	125UA	20V	40
2N2553	P	GEN,TII,MOT	541	To 46	100	60	7.0	3.000A	20.000W	100J	225G	125UA	20V	40
2N2554	P	GEN,TII,MOT	541	To 46	100	60	7.0	3.000A	20.000W	100J	225G	125UA	20V	40
2N2555	P	GEN,TII,MOT	541	To 46	100	60	7.0	3.000A	20.000W	100J	225G	125UA	20V	40
2N2556	P	GEN,TII,MOT	541	To 46	100	60	7.0	3.000A	20.000W	100J	225G	125UA	20V	40
2N2557	P	GEN,TII,MOT	541	To 46	100	60	7.0	3.000A	20.000W	100J	225G	125UA	20V	40
2N2558	P	GEN,TII,MOT	541	To 46	100	60	7.0	3.000A	20.000W	100J	225G	125UA	20V	40
2N2559	P	GEN,TII,MOT	541	To 46	100	60	7.0	3.000A	20.000W	100J	225G	125UA	20V	40
2N2560	P	GEN,TII,MOT	541	To 46	100	60	7.0	3.000A	20.000W	100J	225G	125UA	20V	40
2N2561	P	GEN,TII,MOT	541	To 46	100	60	7.0	3.000A	20.000W	100J	225G	125UA	20V	40
2N2562	P	GEN,TII,MOT	541	To 46	100	60	7.0	3.000A	20.000W	100J	225G	125UA	20V	40
2N2563	P	GEN,TII,MOT	541	To 46	100	60	7.0	3.000A	20.000W	100J	225G	125UA	20V	40
2N2564	P	GEN,TII,MOT	211	To 5	40	30	20.0	3.500A	.400W	100J	225G	125UA	50V	40
2N2565	P	GEN,TII,MOT	211	To 5	60	40	20.0	3.500A	.400W	100J	225G	125UA	50V	40
2N2566	P	GEN,TII,MOT	211	To 5	80	50	20.0	3.500A	.400W	100J	225G	125UA	50V	40
2N2567	P	GEN,TII,MOT	211	To 5	100	60	20.0	3.500A	.400W	100J	225G	125UA	50V	40
2N2568	P	GEN,TII,MOT	210	To 18	20	15	5.0	.100A	.300W	175J	100.000G	10NA	15V	100
2N2569	P	AMP	405	To 36	400	325	5.0	10.000A	150W	2.500G	5MA	400V	20	5.000A
2N2570	N	AMP	405	To 36	400	325	5.0	10.000A	150W	2.500G	5MA	400V	20	5.000A
2N2580	N	DEL	405	To 36	500	325	5.0	10.000A	150W	2.500G	5MA	400V	20	5.000A
2N2581	N	DEL	405	To 36	500	325	5.0	10.000A	150W	2.500G	5MA	400V	20	5.000A
2N2582	N	DEL	405	To 36	500	325	5.0	10.000A	150W	2.500G	5MA	400V	20	5.000A
2N2583	N	DEL	405	To 36	500	325	5.0	10.000A	150W	2.500G	5MA	400V	20	5.000A
2N2586	N	ITT,TII,RAY,NSC,SOL,TEC	211	To 18	60	45	6.0	.300A	.300W	175J	45.000G	2NA	45V	300
2N2590	P	SOL,SSD,HUG	211	To 46	100	60	7.0	.050A	.400W	200J	50.000G	25NA	80V	30
2N2591	P	SOL,SSD,HUG	211	To 46	100	60	7.0	.050A	.400W	200J	50.000G	25NA	80V	30
2N2592	P	SOL,SSD,HUG	211	To 46	100	60	7.0	.050A	.400W	200J	50.000G	25NA	80V	30
2N2593	P	SOL,SSD,HUG	211	To 46	100	60	7.0	.050A	.400W	200J	50.000G	25NA	80V	30
2N2594	P	SOL,SSD,HUG	211	To 46	100	60	7.0	.050A	.400W	200J	50.000G	25NA	80V	30
2N2595	P	TRW,TEC,HUG	211	To 46	80	80	7.0	5.000G	.400W	200J	40.000G	100NA	80V	86
2N2596	P	SOL,SSD,HUG	211	To 46	80	60	6.0	.050A	.400W	200J	30.000G	25NA	50V	30
2N2597	P	SOL,SSD,HUG	211	To 46	80	60	6.0	.050A	.400W	200J	30.000G	25NA	50V	30
2N2598	P	SES,SOL,TEC,HUG	211	To 46	125	80	7.0	.050A	.400W	200J	60.000G	25NA	50V	120
2N2599	P	SES,SOL,SSD,TEC,HUG	210	To 46	125	80	7.0	.050A	.400W	200J	30.000G	25NA	80V	30
2N2599A	P	SOL,SSD,HUG	211	To 46	125	100	7.0	.050A	.400W	200J	40.000G	25NA	80V	60
2N2600	P	SES,SOL,SSD,TEC,HUG	210	To 46	125	80	7.0	.050A	.400W	200J	40.000G	25NA	80V	60
2N2600A	P	SOL,SSD,HUG	211	To 46	125									

Transistor Type No.	N P S	G P S	Manufacturer	Lead Ident	Out- line	Maximum (V)			Maximum		Max. T.(°C)	Frequency Resp.(MHz)	Leakage		Gain		
						V _{CE}	V _{BE}	V _{EB}	I _C	Power			I _{CEO} @ V _{CE}	I _{EB} @ V _{BE}			
2N2632	N	S	SOL,BEN,HUG	560	TO 62	90	60	8.0	5.000A	40.000W	200J	60.000G	100NA	60V	80	1.000A	
2N2633	N	S	SOL,BEN,HUG	560	TO 62	120	80	8.0	5.000A	40.000W	200J	60.000G	100NA	60V	80	1.000A	
2N2634	N	S	SOL,BEN,HUG	560	TO 62	150	100	8.0	5.000A	40.000W	200J	0.000G	100NA	60V	80	1.000A	
2N2635	N	P	G TI1, MOT	210	TO 18	30	15	2.5	1.00A	150W	100J	150.000G	5UA	25V	150	.050A	
2N2636	N	P	G TI1, MOT	607	TO 41	100	100S		25.000A	100.000W	110J	0.01E	10MA	100V	40	25.000A	
2N2637	P	G	BEN	607	TO 41	100	100S		25.000A	100.000W	110J	0.01E	300UA	2V	40	25.000A	
2N2638	P	G	BEN	607	TO 41	100	100S		25.000A	100.000W	110J	0.01E	10MA	100V	80	1.50A	
2N2645	N	S	SES, RAY	211	TO 18	75	50R	7.0	5.000A	1.250W	200J	60.000G	10NA	60V	160	.01A	
2N2648	N	S	GTC	211	TO 5	35	10	30.0	3.000A	300W	100J	10.000G	5UA	15V	300		
2N2651	N	S	FSC	211	TO 18	40	20	5.0	5.00A	.360W	200J	350.000G	30NA	25V	37	.010A	
2N2654	N	S	AMP	541	TO 12	32	15	5.0	1.01A	150W	85J	125.000G	8UA	10V	150		
2N2656	N	S	TRW	210	TO 18	25	15	5.0	2.00A	.360W	200J	250.000G	500NA	15V	66	.001A	
2N2657	N	S	SOL, SSP, STC, BEN, NSC, FSC	211	TO 5	80	60	8.0	5.000A	1.250W	200J	20.000G	100NA	60V	80	1.000A	
2N2658	N	S	SOL, SSP, STC, BEN, NSC, FSC	211	TO 5	100	80	8.0	5.000A	1.250W	200J	20.000G	100NA	60V	80	1.000A	
2N2659	P	G	TI1	211	TO 11	50	50	20.0	3.000A	15.000W	100A	2.80G	125UA	25V	70		
2N2660	P	G	TI1	211	TO 11	70	70	20.0	3.000A	15.000W	100A	3.00G	125UA	35V	70		
2N2661	P	G	TI1	211	TO 11	50	50	20.0	3.000A	15.000W	100A	3.00G	125UA	25V	110		
2N2662	P	G	TI1	541	541B	50	50	20.0	3.000A	15.000W	100A	2.80G	125UA	45V	70		
2N2663	P	G	TI1	541	541B	70	70	20.0	3.000A	15.000W	100A	2.80G	125UA	45V	70		
2N2664	P	G	TI1	541	541B	90	90	20.0	3.000A	15.000W	100A	2.80G	125UA	45V	70		
2N2665	P	G	TI1	211	TO 11	70	70	20.0	3.000A	15.000W	100A	3.00G	125UA	35V	110		
2N2666	P	G	TI1	211	TO 11	90	90	20.0	3.000A	15.000W	100A	3.00G	125UA	45V	110		
2N2667	P	G	TI1	211	TO 11	90	90	20.0	3.000A	15.000W	100A	3.00G	125UA	45V	110		
2N2668	P	G	TI1	541	541B	50	50	20.0	3.000A	15.000W	100A	3.00G	125UA	35V	110		
2N2669	P	G	TI1	541	541B	70	70	20.0	3.000A	15.000W	100A	3.00G	125UA	35V	110		
2N2670	P	G	TI1	541	541B	90	90	20.0	3.000A	15.000W	100A	3.00G	125UA	45V	110		
2N2671	P	G	AMP	217	TO 12	32	14	1.0	0.10A	100W	75J	44.000G	8UA	6V	140		
2N2672	P	G	AMP	210	TO 39	32	14	1.0	0.10A	100W	85J	44.000G	8UA	6V	140		
2N2673	N	S	GEC	210	TO 46	60	45	3.0	0.25A	250W	175J	2.500B	100NA	30V	16		
2N2674	N	S	GEC	210	TO 46	60	45	3.0	0.25A	250W	175J	5.000B	100NA	30V	32		
2N2675	N	S	GEC	210	TO 46	60	45	3.0	0.25A	250W	175J	10.000B	100NA	30V	46		
2N2676	N	S	GEC	210	TO 46	60	45	3.0	0.25A	250W	175J	10.000B	100NA	30V	450		
2N2677	N	S	GEC	210	TO 46	45	35	2.0	0.25A	250W	175J	10.000B	100NA	30V	100		
2N2678	N	S	GEC	607	TO 41	100	45	35	2.0	0.25A	250W	175J	20.000B	100NA	30V	100	
2N2691	P	G	BEN	607	TO 41	100	100	8.0	50.000A	100.000W	110J	.01E	5MA	100V	55	20.000A	
2N2691A	P	G	BEN	607	TO 41	120	100	10.0	50.000A	170.000W	110J	.01E	5MA	120V	75	20.000A	
2N2692	N	S	TI1	211	TO 18	45	30	10.0	0.50A	.300W	175J	42.000G	10NA	25V	120		
2N2693	N	S	TI1	211	TO 18	45	30	10.0	0.50A	.300W	175J	42.000G	10NA	25V	120		
2N2694	N	S	TI1	211	TO 18	45	20	10.0	0.50A	.300W	175J	42.000G	10NA	25V	60		
2N2695	N	S	TI1, RAY, TEC, MOT, HUG	211	TO 46	25	25	4.0	5.00A	.360W	200J	100.000G	25NA	10V	80	.050A	
2N2696	P	S	TI1, RAY, TEC, HUG	211	TO 18	25	25	4.0	5.00A	.360W	200J	100.000G	25NA	10V	80	.050A	
2N2697	N	S	SOL,BEN,HUG	490	490A	80	60	8.0	5.000A	20.000W	200J	60.000G	100NA	60V	80	1.000A	
2N2698	N	S	SOL,BEN,HUG	490	490A	100	80	8.0	5.000A	20.000W	200J	60.000G	100NA	60V	80	1.000A	
2N2706	P	G	AMP	120	TO 1	32	32S	10.0	.200A	.165W	75J	1.300G	200UA	32V	120		
2N2707	M	P	M.P. 2N2706, 2N2430														
2N2708	N	S	RCA, RAY, MOT, GIC, HUG	217	TO 72	35	20	3.0	5.00A	100W	200J	700.000G	10NA	15V	100	.002A	
2N2710	N	S	FSC, MOT	211	TO 18	40	50	5.0	5.00A	.300W	175J	500.000G	30NA	20V	60	.010A	
2N2711	N	S	GEC, SPR, HUG	45	TO 98	18	18	5.0	1.00A	.200W	100J	200.000G	500UA	18V	60		
2N2712	N	S	GEC, SPR, HUG	45	TO 98	18	18	5.0	1.00A	.200W	100J	300.000G	500UA	18V	150		
2N2713	N	S	GEC, SPR, SES, HUG	45	TO 98	18	18	5.0	2.00A	.200W	100J	150.000G	500UA	18V	60		
2N2714	N	S	GEC, SPR, SES, HUG	45	TO 98	18	18	5.0	2.00A	.200W	100J	200.000G	500UA	18V	60		
2N2715	N	S	GEC	45	TO 98	18	18	5.0	0.25A	.200W	100J	100.000G	500UA	18V	60		
2N2716	N	S	GEC	45	TO 98	18	18	5.0	0.25A	.200W	100J	150.000G	500UA	18V	150		
2N2726	N	S	TEC, HUG	211	TO 5	200	200R	10.0	1.000W	1.000W	200J	15.000G	1UA	100V	60	.200A	
2N2727	N	S	TEC, HUG	211	TO 5	200	200R	10.0	1.000W	1.000W	200J	15.000G	1UA	100V	120	.200A	
2N2728	P	G	MOT	405	TO 36	15	5	15.0	50.000A	170.000W	110J	.03E	10MA	15V	74	20.000A	
2N2729	N	S	TT	211	TO 46	30	15	3.0	0.50A	.300W	200J	600.000G	10NA	15V	50	.003A	
2N2730	P	G	SOL, HUG	405	TO 36	80	60	30.0	65.000A	170.000W	110J	.350G	5MA	80V	70	25.000A	
2N2731	P	G	SOL, HUG	405	TO 36	60	45	30.0	65.000A	170.000W	110J	.350G	5MA	60V	70	25.000A	
2N2732	P	G	SOL, HUG	405	TO 36	40	30	20.0	65.000A	170.000W	110J	.350G	5MA	70V	25.000A		
2N2733	P	G	SOL, HUG	176	176E	80	30	20.0	65.000A	140.000W	110J	.350G	5MA	80V	70	25.000A	
2N2734	P	G	SOL, HUG	176	176E	60	45	20.0	65.000A	140.000W	110J	.350G	5MA	60V	70	25.000A	
2N2735	P	G	SOL	176	176E	40	30	20.0	65.000A	140.000W	110J	.350G	5MA	40V	70	25.000A	
2N2736	P	G	SOL, HUG	571	571A	80	60	30.0	65.000A	140.000W	110J	.350G	5MA	80V	70	25.000A	
2N2737	P	G	SOL, HUG	571	571A	60	45	30.0	65.000A	140.000W	110J	.350G	5MA	60V	70	25.000A	
2N2738	P	G	SOL, HUG	571	571A	40	30	20.0	65.000A	140.000W	110J	.350G	5MA	40V	70	25.000A	
2N2739	N	S	WHE, ETC, SPC	412	TO 82	50	50	15.0	20.000A	200.000W	175J	.200G	30MA	50V	15	10.000A	
2N2740	N	S	WHE, ETC, SPC	412	TO 82	100	100	15.0	20.000A	200.000W	175J	.200G	30MA	100V	15	10.000A	
2N2741	N	S	WHE, ETC, SPC	412	TO 82	150	150	15.0	20.000A	200.000W	175J	.200G	30MA	150V	15	10.000A	
2N2742	N	S	WHE, ETC, SPC	412	TO 82	200	200	15.0	20.000A	200.000W	175J	.200G	30MA	200V	15	10.000A	
2N2745	N	S	WHE, SPC	412	TO 82	50	50	15.0	20.000A	200.000W	175J	.200G	30MA	50V	15	15.000A	
2N2746	N	S	WHE, SPC	412	TO 82	100	100	15.0	20.000A	200.000W	175J	.200G	30MA	100V	15	15.000A	
2N2747	N	S	WHE, SPC	412	TO 82	150	150	15.0	20.000A	200.000W	175J	.200G	30MA	150V	15	15.000A	
2N2748	N	S	WHE, SPC	412	TO 82	200	200	15.0	20.000A	200.000W	175J	.200G	30MA	200V	15	15.000A	
2N2751	N	S	WHE, SPC	412	TO 82	50	50	15.0	20.000A	200.000W	175J	.200G	30MA	50V	15	10.000A	
2N2752	N	S	WHE, SPC	412	TO 82	100	100	15.0	20.000A	200.000W	175J	.200G	30MA	100V	15	10.000A	
2N2753	N	S	WHE, SPC	412	TO 82	150	150	15.0	20.000A	200.000W	175J	.200G	30MA	150V	15	10.000A	
2N2754	N	S	WHE, SPC	412	TO 82	200	200	15.0	20.000A	200.000W	175J	.200G	30MA	200V	15	10.000A	
2N2755	N	S	WHE, SPC	561	561F	50	50	15.0	30.000A	200.000W	175J	.200G	30MA	50V	14	10.000A	
2N2756	N	S	WHE, SPC	561	561F	100	100	15.0	30.000A	200.000W	175J	.200G	30MA	100V	14	10.000A	
2N2757	N	S	WHE, SPC	561	561F	150	150	15.0	30.000A	200.000W	175J	.200G	30MA	150V	14	10.000A	
2N2758	N	S	WHE, SPC	561	561F	200	200	15.0									

Transistor Type No.	N P	G S	Manufacturer	Lead Ident	Out. line	Maximum (V)			Maximum		Max. T.(°C)	Frequency Resp.(MHz)	Leakage $I_{c,leak}$ @ V_{ce}	Gain h_{fe} @ I_c		
						V_{ce}	V_{ce}	V_{ce}	I_c	Power						
2N2795	P	G	SPR,HUG	210	To 18	25	25S	2.5	1.00A	.075W	100J	300.000G	3UA	15V	100	
2N2796	P	G	SPR,HUG	210	To 18	20	12	2.0	1.00A	.075W	100J	300.000G	3UA	15V	60	
2N2797	P	G	SPR	170	To 9	40	20	2.5	1.00A	.075W	100J	150.000G	3UA	15V	80	
2N2798	P	G	SPR	170	To 9	60	25	2.5	1.00A	.075W	100J	120.000G	3UA	15V	50	
2N2799	P	G	SPR	170	To 9	30	15	2.0	1.00A	.075W	100J	120.000G	3UA	15V	50	
2N2800	P	S	RAY,MOT,ITT,FSC,HUG	211	To 5	50	35	5.0	800A	.800W	200J	120.000G	100NA	25V	50	
2N2801	P	S	BEN,SOL,ITT,FSC,HUG	211	To 5	50	35	5.0	800A	.800W	200J	120.000G	100NA	25V	120	
2N2811	N	S	BEN,SOL,FSC,HUG	561	To 61	80	60	8.0	10.000A	40.000W	200J	20.000G	100NA	60V	40 5.000A	
2N2812	N	S	BEN,SOL,FSC,HUG	561	To 61	80	60	8.0	10.000A	40.000W	200J	30.000G	100NA	60V	80 5.000A	
2N2813	N	S	BEN,SOL,FSC,HUG	561	To 61	120	80	8.0	10.000A	40.000W	200J	30.000G	100NA	60V	40 5.000A	
2N2814	N	S	BEN,SOL,FSC,HUG	561	To 61	120	80	8.0	10.000A	40.000W	200J	30.000G	100NA	60V	80 5.000A	
2N2815	N	S	SES,SPC	561	To 63	80	80	10.0	20.000A	200.000W	200J	.600G	2MA	80V	22 10.000A	
2N2816	N	S	ETC,SES,SPC	561	To 63	100	100	10.0	20.000A	200.000W	200J	.600G	2MA	100V	22 10.000A	
2N2817	N	S	SES,SPC	561	To 63	150	150	10.0	20.000A	200.000W	200J	.600G	2MA	100V	22 10.000A	
2N2818	N	S	ETC,SES,SPC	561	To 63	200	200	10.0	20.000A	200.000W	200J	.600G	2MA	150V	22 10.000A	
2N2819	N	S	SES,SPC	561	To 63	100	100	10.0	25.000A	200.000W	200C	.600G	2MA	80V	22 10.000A	
2N2820	N	S	SES,SPC	561	To 63	80	80	10.0	25.000A	200.000W	200C	.600G	2MA	80V	22 15.000A	
2N2821	N	S	SES,SPC	561	To 63	100	100	10.0	25.000A	200.000W	200C	.600G	2MA	100V	22 15.000A	
2N2822	N	S	SES,SPC	561	To 63	200	200	10.0	25.000A	200.000W	200C	.600G	2MA	150V	22 15.000A	
2N2823	N	S	SES,SPC	561	To 63	80	80	10.0	30.000A	200.000W	200C	.600G	2MA	200V	22 15.000A	
2N2824	N	S	SES,SPC	561	To 63	150	150	10.0	30.000A	200.000W	200C	.600G	2MA	100V	20 20.000A	
2N2825	N	S	SES,SPC	561	To 63	150	150	10.0	30.000A	200.000W	200C	.600G	2MA	100V	20 20.000A	
2N2826	P	G	OEL	631	To 17	25	15	1.5	.500A	7.500W	100J	.017E	200UA	25V	130	
2N2827	P	G	OEL	631	To 37	40	30	20.0	.500A	7.500W	100J	.017E	200UA	40V	130	
2N2831	N	S	TRW	211	To 18	40	12	3.0	1.00A	1.200W	100J	250.000G	30UA	50V	50 .010A	
2N2832	P	G	MOT	605	To 3	80	50	2.0	20.000A	85.000W	110J	10.000G	10MA	80V	75 1.000A	
2N2833	P	G	MOT	605	To 3	140	75	2.0	20.000A	85.000W	110J	10.000G	10MA	120V	75 1.000A	
2N2834	P	G	MOT	605	To 3	140	100	2.0	20.000A	85.000W	110J	10.000G	10MA	140V	75 1.000A	
2N2836	P	G	AMP	605	To 3	55	55	20.0	5.00A	35.000W	110J	10.000G	10MA	140V	75 1.000A	
2N2837	P	S	RAY,MOT,ITT,GIC,FSC,HUG	211	To 18	50	35	5.0	800A	.500W	200J	120.000G	100NA	25V	150 1.500A	
2N2845	P	S	FSC,SPR,GEC,MOT,TEC,HUG	211	To 18	50	35	5.0	800A	.500W	200J	120.000G	100NA	25V	150 1.500A	
2N2846	N	S	FSC,GEC,MOT,TEC,HUG	211	To 5	60	30	5.0	800A	.360W	200J	250.000G	100NA	50V	70 1.50A	
2N2847	N	S	FSC,GEC,MOT,TEC,HUG	211	To 18	60	20	5.0	800A	.360W	200J	250.000G	100NA	50V	70 1.50A	
2N2848	N	S	FSC,GEC,MOT,TEC,HUG	211	To 5	60	20	5.0	800A	.360W	200J	250.000G	100NA	50V	80 1.50A	
2N2849	N	S	FSC,HUG	211	To 5	60	20	5.0	800A	.360W	200J	250.000G	100NA	50V	80 1.50A	
2N2849-1	N	S	SSP	581	To 5	211B	100	80	5.0	3.000A	.850W	200J	30.000G	100NA	80V	90
2N2849-2	N	S	SSP	581	To 5	211	100	80	5.0	3.000A	.850W	200J	30.000G	100NA	80V	90
2N2849-3	N	S	SSP	581	To 5	581B	100	80	5.0	3.000A	.850W	200J	30.000G	100NA	80V	90
2N2850	N	S	SSP,HUG	546	To 5	546A	100	80	5.0	3.000A	5.000W	200J	30.000G	100NA	80V	90
2N2850-1	N	S	SSP,BEN	211	To 5	211B	100	80	5.0	3.000A	.850W	200J	30.000G	100NA	80V	90
2N2850-2	N	S	SSP	581	To 5	581	100	80	5.0	3.000A	.850W	200J	30.000G	100NA	80V	90
2N2850-3	N	S	SSP	546	To 5	546A	100	80	5.0	3.000A	5.000W	200J	30.000G	100NA	80V	90
2N2851-1	N	S	SSP,BEN	211	To 5	211B	100	80	5.0	3.000A	.850W	200J	30.000G	100NA	80V	90
2N2851-2	N	S	SSP	581	To 5	581B	100	80	5.0	3.000A	.850W	200J	30.000G	100NA	80V	90
2N2851-3	N	S	SSP	546	To 5	546A	100	80	5.0	3.000A	5.000W	200J	30.000G	100NA	80V	90
2N2852	N	S	SSP,HUG	211	To 5	211B	100	80	5.0	3.000A	5.000W	200J	30.000G	100NA	80V	90
2N2852-1	N	S	SSP,BEN	211	To 5	211B	100	80	5.0	3.000A	.850W	200J	30.000G	100NA	80V	90
2N2852-2	N	S	SSP	581	To 5	581B	100	80	5.0	3.000A	.850W	200J	30.000G	100NA	80V	90
2N2852-3	N	S	SSP	546	To 5	546A	100	80	5.0	3.000A	5.000W	200J	30.000G	100NA	80V	90
2N2853	N	S	SSP,HUG	211	To 5	211B	100	80	5.0	3.000A	.850W	200J	30.000G	100NA	80V	90
2N2853-1	N	S	SSP,BEN	211	To 5	211B	100	80	5.0	3.000A	.850W	200J	30.000G	100NA	80V	90
2N2853-2	N	S	SSP	581	To 5	581B	100	80	5.0	3.000A	.850W	200J	30.000G	100NA	80V	90
2N2853-3	N	S	SSP	546	To 5	546A	100	80	5.0	3.000A	5.000W	200J	30.000G	100NA	80V	90
2N2854	N	S	SSP,HUG	211	To 5	211B	100	80	5.0	3.000A	5.000W	200J	30.000G	100NA	80V	90
2N2854-1	N	S	SSP	581	To 5	581B	100	80	5.0	3.000A	.850W	200J	30.000G	100NA	80V	90
2N2854-2	N	S	SSP	546	To 5	546A	100	80	5.0	3.000A	5.000W	200J	30.000G	100NA	80V	90
2N2854-3	N	S	SSP	581	To 5	581B	100	80	5.0	3.000A	.850W	200J	30.000G	100NA	80V	90
2N2855	N	S	SSP,BEN	211	To 5	211B	100	80	5.0	3.000A	.850W	200J	30.000G	100NA	80V	90
2N2855-1	N	S	SSP	581	To 5	581B	100	80	5.0	3.000A	.850W	200J	30.000G	100NA	80V	90
2N2855-2	N	S	SSP	546	To 5	546A	100	80	5.0	3.000A	5.000W	200J	30.000G	100NA	80V	90
2N2855-3	N	S	SSP	581	To 5	581B	100	80	5.0	3.000A	.850W	200J	30.000G	100NA	80V	90
2N2856	N	S	SSP,HUG	211	To 5	211B	100	80	5.0	3.000A	5.000W	200J	30.000G	100NA	80V	90
2N2856-1	N	S	SSP,BEN	211	To 5	211B	100	80	5.0	3.000A	.850W	200J	30.000G	100NA	80V	90
2N2856-2	N	S	SSP	581	To 5	581B	100	80	5.0	3.000A	.850W	200J	30.000G	100NA	80V	90
2N2856-3	N	S	SSP	546	To 5	546A	100	80	5.0	3.000A	5.000W	200J	30.000G	100NA	80V	90
2N2857	N	S	RCA,AMP,MOT,HUG	546	To 5	546A	60	40	5.0	3.000A	5.000W	200J	20.000G	100NA	40V	25
2N2861	P	S	TI,RAY,TEC,HUG	211	To 18	20	15	2.5	.022A	.300W	200J	900.000G	10NA	15V	68 .003A	
2N2862	P	S	TI,RAY,TEC,HUG	211	To 18	25	20	5.0	1.00A	.300W	200J	60.000G	10NA	25V	70 .011A	
2N2863	P	S	TI,RAY,TEC,HUG	211	To 5	60	25	5.0	1.00A	.800W	200J	150.000G	500NA	30V	110 .011A	
2N2864	N	S	TI,RAY,HUG	211	To 5	60	25	5.0	1.00A	.800W	200J	150.000G	500NA	30V	110	
2N2865	N	S	TI,RAY,HUG	211	To 5	60	25	5.0	1.00A	.800W	200J	150.000G	500NA	30V	110	
2N2868	N	S	GEC,ITT,SES,RAY,HUG	217	To 5	60	40	7.0	1.00A	.200W	200J	600.000G	10NA	15V	110	
2N2869	P	G	ETC,BEN,HUG	605	To 3	60	50	10.0	10.000A	30.000W	100J	50.000G	10NA	30V	80 1.50A	
2N2869/2N301	P	G	RCA,SOL	605	To 3	60	50	10.0	10.000A	30.000W	100J	.200G	500UA	30V	90 1.000A	
2N2870	P	G	ETC,BEN,HUG	605	To 3	80	50	10.0	10.000A	30.000W	100J	.200G	500UA	30V	90 1.000A	
2N2870/2N301A	P	G	RCA,SOL	605	To 3	80	50	10.0	10.000A	30.000W	100J	.200G	500UA	30V	100 1.000A	
2N2874	P	S	SEE RF POWER SECTION	585	To 5	585A	60	50	5.0	2.000A	20.000W	200C	25.000G	1UA	30V	30 .050A
2N2875	P	S	SEE RF POWER SECTION	585	To 5	585A	60	50	5.0	2.000A	20.000W	200C	25.000G	1UA	30V	30 .050A
2N2876	P	S	SEE RF POWER SECTION	585	To 5	585A	60	50	5.0	2.000A	20.000W	200C	25.000G	1UA	30V	30 .050A
2N2877	N	S	STC,SOL,TEC,BEN,HUG	581	To 111	80	60	8.0	5.000A	30.000W	200J	30.000G	100NA	60V	40 1.000A	
2N2878	N	S	STC,SOL,NSC,TEC,BEN,HUG	581	To 111	80	60	8.0	5.000A	30.000W	200J	30.000G	100NA	60V	80 1.000A	
2N2879	N	S	STC,SOL,TEC,BEN,HUG	581	To 111	100	80	8.0	5.000A	30.000W	200J	30.000G	100NA	60V	80 1.000A	
2N28																

Transistor Type No.	N P	G S	Manufacturer	Lead Ident	Out- line	Maximum (V)			Maximum			Temp. (°C)	Frequency Resp.(MHz)	Leakage		Gain	
						V _{CE}	V _{ES}	V _{BE}	I _C	Power	I _{CE}			I _{ES} @ V _{BE}	h _{FE} @ I _C		
2N2907A	P	S	TIH, SPR, RAY, MOT, FSC, GIC	211	To 18	60	60	5.0	.600A	.400W	200J	200.000G	10A	50V	200	.150A	
2N2909	P	S	TRW, GEC	211	To 46	60	40	7.0		2.000W		50.000G	10A	15V	70	.150A	
2N2912	N	P	SES	171	To 17L	15	5	1.5	25.000A	75.000W	110J	10.000G	10A	15V	400	5.000A	
2N2921	P	S	SES	43	To 98	25	25	5.0	.100A	.200W	100J	200.000G	500A	25V	30	.002A	
2N2922	N	S	SES	43	To 98	25	25	5.0	.100A	.200W	100J	200.000G	500A	25V	40	.002A	
2N2923	N	S	GEC, SPR, SES, HUG	45	To 98	25	25	5.0	.100A	.200W	100J	160.000G	500A	25V	116	.002A	
2N2924	N	S	GEC, SPR, SES, HUG	45	To 98	25	25	5.0	.100A	.200W	100J	160.000G	500A	25V	156	.002A	
2N2925	N	S	GEC, SPR, SES, HUG	45	To 98	25	25	5.0	.100A	.200W	100J	160.000G	500A	25V	216	.002A	
2N2926-BRN	N	S	GEC, SPR, SES	45	To 98	18	18	5.0	.100A	.200W	100J	150.000G	500A	18V	350		
2N2926-GRN	N	S	GEC, SPR, SES	45	To 98	18	18	5.0	.100A	.200W	100J	150.000G	500A	18V	135		
2N2926-ORG	N	S	GEC, SPR, SES	45	To 98	18	18	5.0	.100A	.200W	100J	150.000G	500A	18V	74		
2N2926-RED	N	S	GEC, SPR, SES	45	To 98	18	18	5.0	.100A	.200W	100J	150.000G	500A	18V	225		
2N2926-YEL	N	S	GEC, SPR, SES	45	To 98	18	18	5.0	.100A	.200W	100J	150.000G	500A	18V	80	.050A	
2N2927	P	S	HUG	211	To 5	25	25	4.0	.500A	.800W	200J	800.000G	5UA	10V	30	.10A	
2N2929	P	S	MOT	211	To 52	25	13	5.0	.500A	.300W	175C	500.000G	25A	60V	140		
2N2938	N	S	RCA	211	To 5	75	60	7.0	1.000A	5.000W	200J	150.000G	25A	10V	140		
2N2939	N	S	BEN	211	To 5	120	80	7.0	1.000A	5.000W	200J	150.000G	25A	10V	140		
2N2940	N	S	BEN	211	To 5	150	100	7.0	1.000A	5.000W	200J	150.000G	25A	10V	140		
2N2941	N	S	BEN	170	To 9	50	25	2.5	.100A	.150W	100J	150.000G	2UA	25V	80		
2N2942	P	G	SPR	170	To 9	30	15	2.0	.100A	.150W	100J	120.000G	3UA	15V	50		
2N2943	P	G	SPR	170	To 9	30	15	2.0	.100A	.150W	100J	120.000G	3UA	15V	50		
2N2944	P	S	RAY, SPR, TIH, SOL, SSD, TEC	211	To 46	15	10	15.0	.100A	.400W	200J	10.000G	1NA	15V	200	.001A	
2N2944A	P	S	TIH, RAY, TEC	211	To 46	15	10	15.0	.100A	.400W	200J	15.000G	1NA	15V	200	.001A	
2N2945	P	S	RAY, SPR, TIH, NSC, SOL, SSD	211	To 46	25	20	25.0	.100A	.400W	200J	10.000G	1NA	25V	140	.001A	
2N2945A	P	S	TIH, RAY, TEC, MOT	211	To 46	40	35	40.0	.100A	.400W	200J	3.000G	1NA	40V	70	.001A	
2N2946	P	S	RAY, SPR, TIH, NSC, SOL, SSD	211	To 46	40	35	40.0	.100A	.400W	200J	5.000G	1NA	40V	100	.001A	
2N2946A	P	S	TIH, RAY, TEC, MOT	211	To 46	40	35	40.0	.100A	.400W	200J	100.000G	1UA	50V	10	.400A	
2N2947	N	S	MOT	605	To 3	60	60S	3.0	7.00A	25.000W	175J	100.000G	1UA	30V	30	.040A	
2N2948	N	S	MOT	605	To 3	60	60S	3.0	7.00A	25.000W	175J	100.000G	1UA	30V	30	.040A	
2N2949	N	S	MOT	171	To 171D	60	60S	3.0	7.00A	5.00W	175J	100.000G	100A	50V	30	.040A	
2N2950	N	S	MOT	546	To 546B	60	60S	3.0	7.00A	6.00W	175J	100.000G	100A	50V	30	.040A	
2N2951	N	S	MOT, TRW, SES, SPR, HUG	210	To 5	60	60S	5.0	.250A	.800W	175J	200.000G	100A	50V	60	.010A	
2N2952	N	S	MOT, TRW, SPR, HUG	210	To 18	95	80	7.0	1.000A	15.000W	175J	30.000G	25A	10V	150		
2N2953	N	S	MOT	121	To 1	25R	25.0	15.0A	.120W	100J	10.000G	10.000G	5UA	20V	150		
2N2955	P	G	MOT	210	To 18	40	25	3.5	.100A	.150W	100J	200.000G	10UA	25V	43	.010A	
2N2956	P	G	MOT	210	To 18	40	20	3.5	.100A	.150W	100J	250.000G	10UA	25V	105	.010A	
2N2957	P	G	MOT	210	To 18	40	20	3.5	.100A	.150W	100J	300.000G	10UA	25V	105	.010A	
2N2958	P	G	MOT	210	To 18	40	20	3.5	.100A	.150W	100J	300.000G	10UA	25V	105	.010A	
2N2959	P	S	SPR, MOT, TRW, RAY, HUG	210	To 5	60	20	5.0	.600A	.600W	200J	250.000G	25A	50V	80	.150A	
2N2960	N	S	TRW, RAY	211	To 5	60	30	5.0	.600A	.600W	200J	250.000G	25A	50V	170	.150A	
2N2961	N	S	TRW, RAY	211	To 5	60	30	5.0	.600A	.600W	200J	500.000G	25A	50V	170	.150A	
2N2962	P	G	SPR	546	To 546C	40	18	1.5	.300A	.300W	100A	700.000G	5UA	10V	100		
2N2963	P	G	SPR	546	To 546C	40	18	1.5	.300A	.300W	100A	700.000G	5UA	10V	100		
2N2964	P	G	SPR	546	To 546C	30	15	1.5	.300A	.300W	100A	700.000G	5UA	10V	100		
2N2965	P	G	SPR	546	To 546C	30	15	1.5	.300A	.300W	100A	700.000G	5UA	10V	100		
2N2968	P	S	SPR, HUG	210	To 5	30	10	30.0	.050A	.150W	140J	10.000G	10A	15V	30	.001A	
2N2969	P	S	SPR, HUG	210	To 5	30	10	30.0	.050A	.150W	140J	8.000G	10A	15V	20	.001A	
2N2970	P	S	SPR, HUG	210	To 5	30	10	30.0	.050A	.150W	140J	8.000G	10A	15V	20	.001A	
2N2971	P	S	SPR, HUG	210	To 18	30	20	30.0	.050A	.150W	140J	8.000G	10A	15V	20	.001A	
2N2983	N	S	HUG	211	To 5	155	80	8.0	3.000A	15.000W	175J	18.000G	10A	180V	35	.500A	
2N2984	N	S	HUG	211	To 5	185	120	8.0	3.000A	15.000W	175J	18.000G	10A	180V	70	.500A	
2N2985	N	S	HUG	211	To 5	185	120	8.0	3.000A	15.000W	175J	18.000G	10A	180V	70	.500A	
2N2986	N	S	HUG	211	To 5	155	100	7.0	1.000A	15.000W	175J	30.000G	25A	90V	50	.200A	
2N2987	N	S	TIH, TEC, HUG	211	To 5	95	80	7.0	1.000A	15.000W	175J	30.000G	25A	10V	90	.200A	
2N2988	N	S	TIH, TEC, HUG	211	To 5	155	100	7.0	1.000A	15.000W	175J	30.000G	25A	90V	90	.200A	
2N2989	N	S	TIH, TEC, HUG	211	To 5	155	100	7.0	1.000A	15.000W	175J	30.000G	25A	10V	90	.200A	
2N2990	N	S	TIH, TEC, HUG	211	To 5	155	100	7.0	1.000A	15.000W	175J	30.000G	25A	10V	90	.200A	
2N2991	N	S	TIH, TEC	541	To 541D	95	80	7.0	1.000A	15.000W	175J	30.000G	25A	150V	50	.200A	
2N2992	N	S	TIH, TEC	541	To 541D	155	100	7.0	1.000A	15.000W	175J	30.000G	25A	150V	50	.200A	
2N2993	N	S	TIH, TEC	541	To 541D	95	80	7.0	1.000A	15.000W	175J	30.000G	25A	150V	90	.200A	
2N2994	N	S	TIH, TEC	541	To 541D	155	100	7.0	1.000A	15.000W	175J	30.000G	25A	150V	90	.200A	
2N2996	P	G	TIH	217	To 72	15	10	3.0	.050A	.075W	100J	400.000G	5UA	10V	250		
2N2997	P	G	TIH	217	To 72	30	15	3.0	.050A	.075W	100J	400.000G	5UA	12V	250		
2N2998	P	G	TIH	217	To 72	15	12	3.0	.050A	.075W	100J	600.000G	5UA	10V	20		
2N2999	P	G	TIH	217	To 72	15	10	3.0	.050A	.075W	100J	990.000G	5UA	10V	20		
2N3000	P	G	TIH	217	To 72	15	10	3.0	.050A	.075W	100J	350.000G	500A	20V	80	.030A	
2N3009	N	S	TIH, FSC, MOT, HUG, ITT	211	To 18	15	6	4.0	.050A	.300W	200J	600.000G	10UA	11V	56	.010A	
2N3010	N	S	TIH, FSC, GEC, RAY, TEC, MOT	211	To 18	15	6	4.0	.050A	.300W	200J	400.000G	400A	20V	60	.010A	
2N3011	N	S	TIH, FSC, RAY, RCA, ITT, TEC	211	To 18	30	12	5.0	.200A	.360W	200J	550.000G	300A	20V	60	.030A	
2N3012	N	S	FSC, TIH, ITT, TEC, HUG	211	To 18	12	4	4.0	.200A	.360W	200J	350.000G	300A	20V	80	.030A	
2N3013	N	S	FSC, TIH, ITT, SES, TEC, MOT	211	To 52	40	20	5.0	.200A	.360W	200J	350.000G	300A	20V	80	.030A	
2N3014	N	S	FSC, TIH, ITT, TEC, MOT, HUG	211	To 52	40	20	5.0	.200A	.360W	200J	350.000G	300A	20V	80	.030A	
2N3015	N	S	TIH, FSC, MOT, TEC	211	To 5	60	30	5.0	.800W	.200W	200J	250.000G	200A	30V	76	.150A	
2N3016	N	S	BEN	210	To 5	100	50	4.0	2.500A	5.000W	150J	250.000G	1UA	60V	100		
2N3017	N	S	BEN	541	To 541B	100	50	4.0	5.000A	10.000W	150J	250.000G	1UA	60V	80		
2N3018	N	S	BEN	560	To 5	140	80	7.0	1.000A	.800W	200J	100.000G	10A	90V	200	.150A	
2N3019	N	S	FSC, MOT, TRW, RAY, NSC, TEC	211	To 5	140	80	7.0	1.000A	.800W	200J	80.000G	10A	90V	80	.150A	
2N3020	N	S	FSC, RAY, NSC, TEC, MOT, TRW	211	To 5	140	80	7.0	1.000A	.800W	200J	80.000G	10A	90V	36	1.000A	
2N3021	P	S	MOT	605	To 3	30	30	4.0	3.000A	25.000W	175J	60.000G	200UA	25V	36	1.000A	
2N3022	P	S	MOT	605	To 3	45	45	4.0	3.000A	25.000W	175J	60.000G	200UA	54V	36	1.000A	
2N3023	P	S	MOT	605	To 3	30	30	4.0	3.000A	25.000W	175J	60.000G	200UA	25V	96	1.000A	
2N3024	P	S	MOT	605	To 3	30	30	4.0	3.000A	25.000W	175J	60.000G	200UA	43V	96	1.000A	
2N3025	P	S	MOT	60													

Transistor Type No.	N P S	C P S	Manufacturer	Lead Ident	Out- line	Maximum (V)			Maximum		Max. T.(°C)	Frequency Resp.(MHz)	Leakage I _{rev} @ V _{rs}	Gain h _{FE} @ I _c	
						V _{CE}	V _{ES}	V _{ES}	I _c	Power					
2N3075	P	G	TRW	217	To 12	30	30R		.020A	-.140W	75J	RF AMP	10UA 10V	52	7.000A
2N3076	N	S	AMP	414	To 81	140	100R	5.0							
2N3077	N	S	TEC.HUG	210	To 18	80	60	7.0	.050A	125.000W		50.000G	25MA 100V	120	0010A
2N3078	N	S	TEC.HUG	210	To 18	80	60	7.0	.050A	.360W	200J	60.000G	10NA 45V	120	0010A
2N3079	N	S	DEL	405	To 36	200	5.0		10.000A		150J	2.500G	10NA 45V	22	5.000A
2N3080	N	S	RAY	405	To 36	300	5.0		10.000A		150J	2.500G		22	5.000A
2N3081	N	S	DEL	211	To 5	70	50	6.0	.600A			60.000G	10NA 60V	50	5.00A
2N3107	N	S	FSC.ITT.RAY.HUG	211	To 5	100	60	7.0	.800W		175J	150.000G	10NA 50V	60	15.0A
2N3108	N	S	FSC.ITT.RAY.NSC.TEC.HUG	211	To 5	100	60	7.0	.800W		200J	70.000G	10NA 60V	90	5.00A
2N3109	N	S	FSC.ITT.RAY.NSC.TEC.HUG	211	To 5	80	40	7.0	.800W		200J	70.000G	10NA 60V	90	5.00A
2N3110	N	S	FSC.ITT.RAY.NSC.TEC.HUG	211	To 5	150	150	5.0	.600A		200J	250.000G	10NA 60V	50	5.00A
2N3114	N	S	MOT.TII.TRW.TEC.FSC	211	To 5	80	40	7.0	.800W		200J	60.000G	10NA 60V	50	5.00A
2N3115	N	S	SPR.MOT.TRW.RAY.HUG	210	To 18	60	20	5.0	.600A		200J	40.000G	10NA 100V	60	0.30A
2N3116	N	S	SPR.MOT.TRW.RAY.TEC.HUG	210	To 18	60	20	5.0	.600A		200J	40.000G	10NA 100V	60	0.30A
2N3117	N	S	TII.RAY.NSC.SOL.SSD.TEC	211	To 18	60	60	6.0	.050A	.360W	200J	250.000G	25NA 50V	20	1.50A
2N3118	N	S	TII.RAY.NSC.SOL.SSD.TEC	211	To 18	60	60	6.0	.050A	.360W	200J	60.000G	10NA 45V	400	.011A
2N3119	N	S	RCA.HUG	211	To 5	100	80	4.0	.500A	1.000W	200J	250.000G	50NA 60V	90	10.0A
2N3120	P	S	RAY.HUG.ITT.FSC	211	To 5	45	45	4.0				130.000G	20NA 45V	62	0.50A
2N3121	P	S	RAY.HUG.ITT.FSC	211	To 18	45	45	4.0				130.000G	20NA 45V	62	0.50A
2N3122	N	S	RAY	211	To 5	50	30	5.0				60.000G	10NA 60V	50	3.00A
2N3123	N	S	TRW	211	To 25	60	30	5.0				400.000G	10NA 50V	170	15.0A
2N3127	P	G	MOT	210	To 72	25	20	2.0	.050A	.100W	100J	400.000G	3UA 10V	46	0.03A
2N3133	P	S	MOT.GIC.RAY.ITT.NSC.SPR	210	To 5	50	35	4.0	.600A		200J	200.000G	50NA 30V	70	1.50A
2N3134	P	S	MOT.GIC.RAY.NSC.SPR.TEC	210	To 5	50	35	4.0	.600A		200J	200.000G	50NA 30V	70	1.50A
2N3135	P	S	MOT.GIC.RAY.ITT.NSC.SPR	210	To 18	50	35	4.0	.600A		200J	200.000G	50NA 30V	70	1.50A
2N3136	P	S	MOT.GIC.ETC.RAY.NSC.SPR	210	To 18	50	35	4.0	.600A		200J	200.000G	50NA 30V	70	1.50A
2N3137	N	S	FSC.SES.MOT.HUG	211	To 40	20	20	2.0				500.000G	50NA 20V	70	1.50A
2N3146	P	G	TII	605	To 3	150	65	60.0	15.000A	150.000W	200J	10NA 100V	100	1.00A	
2N3147	P	G	TII	605	To 3	180	75	80.0	15.000A	150.000W	200J	.200G	10MA 180V	600	
2N3149	N	S	STC.SOL.TEC.SPC.HUG	561	T0114	80	80	10.0	70.000A	300.000W	200J	.100G	2MA 80V	20	50.000A
2N3150	N	S	STC.SOL.TEC.SPC.HUG	561	T0114	100	100	10.0	70.000A	300.000W	200J	.100G	2MA 100V	20	50.000A
2N3151	N	S	STC.SOL.TEC.SPC.HUG	561	T0114	150	150	10.0	70.000A	300.000W	200J	.100G	2MA 150V	20	50.000A
2N3163	P	S	STC	561	To 61	40	40	10.0	3.000A	85.000W	200J	HF AMP	1MA 60V	20	0.00A
2N3164	P	S	STC	561	To 61	60	60	10.0	3.000A	85.000W	200J	HF AMP	1MA 60V	20	0.00A
2N3165	P	S	STC	561	To 61	80	80	10.0	3.000A	85.000W	200J	HF AMP	1MA 80V	20	1.000A
2N3166	P	S	STC	561	To 61	100	100	10.0	3.000A	85.000W	200J	HF AMP	1MA 100V	20	1.000A
2N3167	P	S	STC	731	To 53	40	40	10.0	3.000A	85.000W	200J	HF AMP	1MA 40V	20	1.000A
2N3168	P	S	STC	731	To 53	60	60	10.0	3.000A	85.000W	200J	HF AMP	1MA 60V	20	1.000A
2N3169	P	S	STC	731	To 53	80	80	10.0	3.000A	85.000W	200J	HF AMP	1MA 80V	20	1.000A
2N3170	P	S	STC	731	To 53	100	100	10.0	3.000A	85.000W	200J	HF AMP	1MA 100V	20	1.000A
2N3171	P	S	STC	731	To 53	40	40	10.0	3.000A	85.000W	200J	HF AMP	1MA 40V	20	1.000A
2N3172	P	S	STC	605	To 3	60	60	10.0	3.000A	75.000W	200J	HF AMP	1MA 60V	20	1.000A
2N3173	P	S	STC	605	To 3	80	80	10.0	3.000A	75.000W	200J	HF AMP	1MA 80V	20	1.000A
2N3174	P	S	STC	605	To 3	100	100	10.0	3.000A	75.000W	200J	HF AMP	1MA 100V	20	1.000A
2N3175	P	S	STC	561	To 61	40	40	10.0	5.000A	85.000W	200J	HF AMP	1MA 40V	16	2.000A
2N3176	P	S	STC	561	To 61	60	60	10.0	5.000A	85.000W	200J	HF AMP	1MA 60V	16	2.000A
2N3177	P	S	STC	561	To 61	80	80	10.0	5.000A	85.000W	200J	HF AMP	1MA 80V	16	2.000A
2N3178	P	S	STC	561	To 61	100	100	10.0	5.000A	85.000W	200J	HF AMP	1MA 100V	16	2.000A
2N3179	P	S	STC	731	To 53	40	40	10.0	5.000A	85.000W	200J	HF AMP	1MA 40V	16	2.000A
2N3180	P	S	STC	731	To 53	60	60	10.0	5.000A	85.000W	200J	HF AMP	1MA 60V	16	2.000A
2N3181	P	S	STC	731	To 53	80	80	10.0	5.000A	85.000W	200J	HF AMP	1MA 80V	16	2.000A
2N3182	P	S	STC	731	To 53	100	100	10.0	5.000A	85.000W	200J	HF AMP	1MA 100V	16	2.000A
2N3183	P	S	STC	605	To 3	40	40	10.0	5.000A	75.000W	200J	HF AMP	1MA 40V	16	2.000A
2N3184	P	S	STC	605	To 3	60	60	10.0	5.000A	75.000W	200J	HF AMP	1MA 60V	16	2.000A
2N3185	P	S	STC	605	To 3	80	80	10.0	5.000A	75.000W	200J	HF AMP	1MA 80V	16	2.000A
2N3186	P	S	STC	605	To 3	100	100	10.0	5.000A	75.000W	200J	HF AMP	1MA 100V	16	2.000A
2N3187	P	S	STC	561	To 61	40	40	10.0	5.000A	85.000W	200J	HF AMP	1MA 40V	16	2.000A
2N3188	P	S	STC	561	To 61	60	60	10.0	5.000A	85.000W	200J	HF AMP	1MA 60V	16	3.000A
2N3189	P	S	STC	561	To 61	80	80	10.0	5.000A	85.000W	200J	HF AMP	1MA 80V	16	3.000A
2N3190	P	S	STC	561	To 61	100	100	10.0	5.000A	85.000W	200J	HF AMP	1MA 100V	16	3.000A
2N3191	P	S	STC	731	To 53	40	40	10.0	5.000A	85.000W	200J	HF AMP	1MA 40V	16	3.000A
2N3192	P	S	STC	731	To 53	60	60	10.0	5.000A	85.000W	200J	HF AMP	1MA 60V	16	3.000A
2N3193	P	S	STC	731	To 53	80	80	10.0	5.000A	85.000W	200J	HF AMP	1MA 80V	16	3.000A
2N3194	P	S	STC	731	To 53	100	100	10.0	5.000A	85.000W	200J	HF AMP	1MA 100V	16	3.000A
2N3195	P	S	STC	605	To 3	40	40	10.0	5.000A	75.000W	200J	HF AMP	1MA 40V	16	3.000A
2N3196	P	S	STC	605	To 3	60	60	10.0	5.000A	75.000W	200J	HF AMP	1MA 60V	16	3.000A
2N3197	P	S	STC	605	To 3	80	80	10.0	5.000A	75.000W	200J	HF AMP	1MA 80V	16	3.000A
2N3198	P	S	STC	605	To 3	100	100	10.0	5.000A	75.000W	200J	HF AMP	1MA 100V	16	3.000A
2N3209	N	S	RAY.ITT.FSC	211	To 18	20	20	4.0				400.000G	10NA 100V	16	3.000A
2N3210	N	S	RAY.MOT	211	To 18	40	15	5.0				400.000G	10NA 100V	60	0.30A
2N3212	P	G	DEL	631	To 37	100X			5.000A			400.000G	1MA 100V	60	0.10A
2N3213	P	G	DEL	631	To 37	80X	2.0		5.000A			600G	1MA 80V	52	3.000A
2N3215	P	G	DEL	631	To 37	60X	2.0		5.000A			600G	1MA 60V	52	3.000A
2N3217	P	S	RAY.SPR.NSC.SOL.SSO.HUG	605	To 46	15	10	15.0	.100A	-.400W	200J	.600G	1MA 40V	50	3.000A
2N3218	P	S	RAY.SPR.NSC.SOL.SSO.HUG	211	To 46	25	20	25.0	.100A	-.400W	200J	1.000G	1NA 15V	60	.001A
2N3219	P	S	RAY.SPR.NSC.SOL.SSO.HUG	211	To 46	35	40		.100A	-.400W	200J	1.000G	1NA 25V	60	.001A
2N3225	N	S	BEN.ETC	605	To 3	35	35		5.000A	75.000W	200J	.020E	2MA 35V	32	2.000A
2N3227	N	S	MOT.RAY	210	To 18	40	20	6.0	.500A	.360W	200J	500.000G	200NA 20V	180	.01A
2N3229	N	S	SEE RF POWER SECTION												
2N3232	N	S	STC.BEN.WHE.FSC	605	To 3	60	60	6.0	7.500A	117.000W	200J	1.000G	5MA 80V	38	3.000A
2N3233	N	S	STC.WHE.BEN.FSC	605	To 3	100	100	6.0	7.500A	117.000W	200J	1.000G	5MA 110V	38	3.000A
2N3235	N	S	STC.WHE.BEN.MOT	605	To 3	160	160	6.0	7.500A	117.000W	200J	1.000G	5MA 160V	38	3.000A
2N3236	N	S	STC.WHE.BEN	605	To 3	100	90	7.0	15.000A	117.000W	200J	HF AMP	5MA 65V	46	
2N3237	N	S	STC.WHE	605	To 3	90	75	7.0	20.000A	200.000W	200J	HF AMP	5MA 90V	40	
2N3238	N	S	STC.WHE	605	To 3	80	80	8.0	15.000A	150.000W	200J	HF AMP	5MA 80V	16	
2N3239	N	S	STC.WHE	605	To 3	80	80	8.0	15.000A	150.000W	200J	HF AMP	5MA 80V	16	
2N3240	N	S	STC.WHE	605	To 3	160	160R	8.0	15.000A	150.000W	200A	HF AMP	5MA 80V	16	
2N3241A	N	S													

Transistor Type No.	N P S	G P S	Manufacturer	Lead Ident	Out- line	Maximum (V)			Maximum		Max. T.(C)	Frequency Resp.(MHz)	Leakage I _{nr} @ V _n	Gain h _{FE} @ I _c
						V _{CE}	V _{ES}	V _{ES}	I _c	Power				
2N3280	P	G	MOT	217	To 72	30	20	1.0	.050A	.100W	100J	400.000G	5UA 10V	30 .003A
2N3281	P	G	MOT	217	To 72	30	15	.5	.050A	.100W	100J	300.000G	5UA 10V	40 .003A
2N3282	P	G	MOT	217	To 72	30	15	.5	.050A	.100W	100J	300.000G	5UA 10V	40 .003A
2N3283	P	G	MOT	217	To 72	25	25S	.5	.050A	.100W	100J	400.000G	10UA 10V	30 .003A
2N3284	P	G	MOT	217	To 72	25	25S	.5	.050A	.100W	100J	400.000G	10UA 10V	30 .003A
2N3285	P	G	MOT	217	To 72	20	20S	.5	.050A	.100W	100J	400.000G	10UA 10V	15 .003A
2N3286	P	G	MOT	217	To 72	20	20S	.5	.050A	.100W	100J	400.000G	10UA 10V	15 .003A
2N3287	P	S	MOT	217	To 72	40	20	3.0	.050A	.200W	200J	350.000G	10NA 15V	40 .002A
2N3288	P	S	MOT	217	To 72	40	20	3.0	.050A	.200W	200J	350.000G	10NA 15V	40 .002A
2N3289	P	S	MOT	217	To 72	30	15	3.0	.050A	.200W	200J	300.000G	10NA 15V	40 .002A
2N3290	P	S	MOT	217	To 72	30	15	3.0	.050A	.200W	200J	300.000G	10NA 15V	40 .002A
2N3291	P	S	MOT	217	To 72	25	25S	3.0	.050A	.200W	200J	250.000G	100NA 10V	20 .002A
2N3292	P	S	MOT	217	To 72	25	25S	3.0	.050A	.200W	200J	250.000G	100NA 10V	20 .002A
2N3293	P	S	MOT	217	To 72	20	20S	3.0	.050A	.200W	200J	250.000G	100NA 10V	20 .002A
2N3294	P	S	MOT	217	To 72	20	20S	3.0	.050A	.200W	200J	250.000G	100NA 10V	20 .002A
2N3295	P	S	MOT	210	To 5	60	60S	5.0	.250A	.800W	175J	200.000G	100NA 50V	36 .010A
2N3296	P	S	MOT	546	To 102	60	60S	3.0	.700A	6.000W	175J	100.000G	100NA 50V	18 .040A
2N3297	P	S	MOT	605	To 3	60	60S	3.0	1.500A	25.000W	175J	100.000G	100NA 50V	12 .040A
2N3298	P	S	MOT	210	To 18	25	25S	3.0	.100A	.300W	175J	200.000G	500NA 10V	90 .010A
2N3299	P	S	MOT	211	To 5	60	30	5.0	.500A	170.000W	110J	250.000G	10NA 50V	76 .150A
2N3300	P	S	MOT	211	To 5	60	30	5.0	.800W	200W	200J	250.000G	10NA 50V	220 .150A
2N3301	P	S	MOT	211	To 18	60	30	5.0	.360W	.200W	200J	250.000G	10NA 50V	76 .150A
2N3302	P	S	MOT	211	To 18	60	30	5.0	.360W	.200W	200J	250.000G	10NA 50V	220 .150A
2N3303	P	S	MOT	211	To 5	25	12	4.0	1.000A	.600W	200J	450.000G	100UA 15V	60 .300A
2N3304	P	S	MOT	217	To 72	40	35	4.0	.050A	.300W	200J	500.000G	10NA 60V	60 .010A
2N3307	P	S	MOT	217	To 72	40	35	4.0	.050A	.300W	200J	500.000G	10NA 60V	60 .010A
2N3308	P	S	MOT	217	To 72	30	25	3.0	.050A	.200W	200J	300.000G	10UA 15V	90 .002A
2N3309	P	S	MOT	210	To 5	50	50S	3.0	.500A	1.000W	175J	300.000G	500NA 25V	30 .030A
2N3311	P	G	MOT.ETC.HUG	405	To 36	30	20	20.0	5.000A	170.000W	110J	.001E	5MA 30V	90 3.000A
2N3312	P	G	MOT.ETC.HUG	405	To 36	45	30	25.0	5.000A	170.000W	110J	.001E	5MA 40V	90 3.000A
2N3313	P	G	MOT.ETC.HUG	405	To 36	60	40	30.0	5.000A	170.000W	110J	.001E	5MA 60V	90 3.000A
2N3314	P	G	MOT.ETC.HUG	405	To 36	30	20	20.0	5.000A	170.000W	110J	.001E	5MA 30V	150 3.000A
2N3315	P	G	MOT.ETC.HUG	405	To 36	45	30	25.0	5.000A	170.000W	110J	.001E	5MA 45V	150 3.000A
2N3316	P	G	MOT.ETC.HUG	405	To 36	60	40	30.0	5.000A	170.000W	110J	.001E	5MA 60V	150 3.000A
2N3317	P	G	MOT.ETC.HUG	405	To 36	40	30	20.0	5.000A	170.000W	110J	.001E	5MA 40V	150 3.000A
2N3318	P	S	SPR.HUG	170	To 10	15	15	15.0	.050A	.150W	140A	7.600G	1NA 10V	60 .001A
2N3319	P	S	SPR.HUG	170	To 10	10	10	10.0	.150W	.140A	140A	12.000G	3NA 6V	60 .001A
2N3320	P	G	SPR.HUG	210	To 18	15	10	2.0	.100A	.075W	100A	600.000G	5NA 10V	80 .020A
2N3321	P	G	SPR.HUG	210	To 18	12	7	2.0	.100A	.075W	100A	600.000G	5NA 6V	140 .020A
2N3322	P	G	SPR.HUG	210	To 18	12	7	2.0	.100A	.075W	100A	600.000G	5NA 6V	140 .020A
2N3323	P	G	MOT	210	To 18	35	35S	3.0	.100A	.150W	100J	200.000G	10UA 10V	80 .003A
2N3324	P	G	MOT	210	To 18	35	35S	3.0	.100A	.150W	100J	200.000G	10UA 10V	80 .003A
2N3325	P	G	MOT	210	To 18	35	35S	3.0	.100A	.150W	100J	200.000G	10UA 10V	80 .003A
2N3326	P	S	RAY.HUG	211	To 45	60	45	5.0	.030A	.400W	175J	70.000G	10NA 25V	60 .001A
2N3340	P	S	SOL.SSO.HUG	211	To 46	30	20	5.0	.030A	.400W	175J	50.000G	10NA 24V	60 .001A
2N3342	P	S	SOL.SSO.HUG	210	To 5	20	8	20.0	.050A	.250W	175J	2.000G	2NA 6V	60 .005A
2N3343	P	S	SOL.SSO.HUG	210	To 5	25	10	20.0	.050A	.250W	175J	2.000G	3NA 6V	30 .001A
2N3344	P	S	SOL.SSO.HUG	210	To 5	30	30	20.0	.050A	.250W	175J	2.000G	5NA 25V	30 .001A
2N3345	P	S	SOL.SSO.HUG	210	To 5	50	50	50.0	.050A	.250W	175J	2.000G	5NA 30V	23 .001A
2N3346	P	S	SOL.SSO.HUG	210	To 5	50	50	50.0	.050A	.250W	175J	2.000G	5NA 40V	38 .001A
2N3371	P	G	ITT	211	To 18	25	10	3.7	.100A	.150W	100A	300.000G	7UA 6V	100 .012A
2N3375	N	S	SEE RF POWER SECTION											
2N3388	N	S	RAY	211	To 5	125	100	6.0	.600W	.200W	100J	36.000G	10NA 60V	90 .003A
2N3390	N	S	GEC.SES	45	To 98	25	25	5.0	.100A	.200W	100J	AUO	100NA 18V	600
2N3391	N	S	GEC.SPR.SES.HUG	45	To 98	25	25	5.0	.100A	.200W	100J	90.000G	100NA 25V	375
2N3391A	N	S	GEC.SPR.SES.HUG	45	To 98	25	25	5.0	.100A	.200W	100J	90.000G	100NA 25V	375
2N3392	N	S	GEC.SPR.SES.HUG	45	To 98	25	25	5.0	.100A	.200W	100J	80.000G	100NA 25V	135
2N3393	N	S	GEC.SPR.SES.HUG	45	To 98	25	25	5.0	.100A	.200W	100J	80.000G	100NA 25V	135
2N3394	N	S	GEC.SPR.SES.HUG	45	To 98	25	25	5.0	.100A	.200W	100J	80.000G	100NA 25V	82
2N3395-WHT	N	S	GEC.SPR.SES.HUG	45	To 98	25	25	5.0	.100A	.200W	100J	AUD	100NA 18V	375
2N3395-ORG	N	S	GEC.SPR.SES.HUG	45	To 98	25	25	5.0	.100A	.200W	100J	AUD	100NA 18V	225
2N3396-WHT	N	S	GEC.SPR.SES.HUG	45	To 98	25	25	5.0	.100A	.135W	100J	AUD	100NA 18V	82
2N3396-ORG	N	S	GEC.SPR.SES.HUG	45	To 98	25	25	5.0	.100A	.135W	100J	AUD	100NA 18V	375
2N3397-YEL	N	S	GEC.SPR.SES.HUG	45	To 98	25	25	5.0	.100A	.135W	100J	AUD	100NA 18V	225
2N3397-ORG	N	S	GEC.SPR.SES.HUG	45	To 98	25	25	5.0	.100A	.135W	100J	AUD	100NA 18V	135
2N3397-RED	N	S	GEC.SPR.SES.HUG	45	To 98	25	25	5.0	.100A	.135W	100J	AUD	100NA 18V	82
2N3397-WHT	N	S	GEC.SPR.SES.HUG	45	To 98	25	25	5.0	.100A	.135W	100J	AUD	100NA 18V	375
2N3397-YEL	N	S	GEC.SPR.SES.HUG	45	To 98	25	25	5.0	.100A	.135W	100J	AUD	100NA 18V	225
2N3398-8LU	N	S	GEC.SPR.SES.HUG	45	To 98	25	25	5.0	.100A	.135W	100J	AUD	100NA 18V	600
2N3398-ORG	N	S	GEC.SPR.SES.HUG	45	To 98	25	25	5.0	.100A	.135W	100J	AUD	100NA 18V	135
2N3398-RED	N	S	GEC.SPR.SES.HUG	45	To 98	25	25	5.0	.100A	.135W	100J	AUD	100NA 18V	82
2N3398-WHT	N	S	GEC.SPR.SES.HUG	45	To 98	25	25	5.0	.100A	.135W	100J	AUD	100NA 18V	375
2N3399	P	G	AMP	217	To 72	20	15	.3	.007A	.080W	90J	300.000G	8UA 20V	40
2N3401	P	S	SOL	210	To 5	25	25	25.0	.100A	.250W	150J	.100B	100NA 20V	30 .001A
2N3402	N	S	GEC.SES.SPR.HUG	45	To 45B	25	25	5.0	.500A	.560W	150J	MS SW	100NA 25V	150
2N3403	N	S	GEC.SES.SPR.HUG	45	To 45B	25	25	5.0	.500A	.560W	150J	MS SW	100NA 25V	360
2N3404	N	S	GEC.SES.SPR.HUG	45	To 45B	50	50	5.0	.500A	.560W	150J	MS SW	100NA 50V	150
2N3405	N	S	GEC.SES.SPR.HUG	45	To 45B	50	50	5.0	.500A	.560W	150J	MS SW	100NA 50V	360
2N3412	G	E	ETC.HUG	210	To 5	20	20S	2.0	.100A	.060W	100J	100.000G	3UA 5V	80 .010A
2N3417	N	S	GEC.SPR.SES.HUG	45	To 98	25	25	5.0	.100A	.360W	150J	MS SW	100NA 25V	15
2N3415	N	S	GEC.SPR.SES.HUG	45	To 98	25	25	5.0	.500A	.360W	150J	MS SW	100NA 25V	360
2N3416	N	S	GEC.SPR.SES.HUG	45	To 98	50	50	5.0	.500A	.360W	150J	MS SW	100NA 50V	150
2N3417	N	S	GEC.SPR.SES.HUG	45	To 98	50	50	5.0	.500A	.360W	150J	MS SW	100NA 50V	360
2N3418	N	S	ITT.BEN.TEC.HUG	211	To 5	155	80	8.0	3.000A	.800W	125C	40.000G	30NA 80V	40
2N3419	N	S	ITT.BEN.TEC.HUG	211	To 5	160	80	8.0	3.000A	.800W	125C	40.000G	30NA 80V	40
2N3420	N	S	ITT.BEN.TEC.HUG	211	To 5	85	60	8.0	3.000A	.800W	125C	40.000G	30NA 80V	80
2N3421	N	S	ITT.BEN.TEC.HUG	211	To 5	125	80	8.0	3.000A	.800W	125C	40.000G	30NA 120V	80
2N3426	N	S	FSC.ITT	211	To 211K	25	12	4.0	1.000A	.600W	200J	200.000G	100UA 15V	60 .300A
2N3427	P	G	MOT.HUG	210	To 5	45	30R	30.0	.500A	.200W	100J	4.000B	50UA 45V	210 .100A
2N3428	P	G	MOT.HUG	210	To 5	45	30R	30.0	.500A	.200W	100J	4.000B	50UA 45V	210 .100A
2N3429	N	S	WHE											

Transistor Type No.	N P	G S	Manufacturer	Lead Ident	Out- line	Maximum (V)			Maximum		Max. T.(°C)	Frequency Resp.(MHz)	Leakage I _{sat} @ V _{ce}	Gain h _{FE} @ I _c		
						V _{ce}	V _{ce}	V _{ce}	I _c	Power						
2N3470	N	S	WHE	561	561F	50	50	15.0	10.000A	150.000W	150J	500G	200UA	50V	360	10.000A
2N3471	N	S	WHE	561	561F	100	100	15.0	10.000A	150.000W	150J	500G	200UA	100V	360	10.000A
2N3472	N	S	WHE	561	561F	150	150	15.0	10.000A	150.000W	150J	500G	200UA	150V	360	10.000A
2N3473	N	S	WHE	561	561F	200	200	15.0	10.000A	150.000W	150J	500G	200UA	200V	360	10.000A
2N3474	N	S	WHE	561	561F	50	50	15.0	10.000A	150.000W	150J	500G	200UA	50V	500	10.000A
2N3475	N	S	WHE	561	561F	100	100	15.0	10.000A	150.000W	150J	500G	200UA	100V	500	10.000A
2N3476	N	S	WHE	561	561F	150	150	15.0	10.000A	150.000W	150J	500G	200UA	150V	500	10.000A
2N3477	N	S	WHE	561	561F	200	200	15.0	10.000A	150.000W	150J	500G	200UA	200V	500	10.000A
2N3478	N	S	RCA	193	TO18	30	15	2.0	.600A	.200W	200J	750.000G	20NA	1V	70	.002A
2N3485	P	S	FSC,TII,MOT,RAY,HUG	211	TO 46	60	40	5.0	.600A	.360W	200J	200.000G	10NA	50V	70	.150A
2N3485A	P	S	FSC,TII,MOT,RAY,HUG	211	TO 46	60	60	5.0	.600A	.360W	200J	200.000G	10NA	50V	70	.150A
2N3486	P	S	FSC,TII,MOT,RAY,HUG	211	TO 46	60	40	5.0	.600A	.360W	200J	200.000G	20NA	50V	160	.150A
2N3486A	P	S	FSC,TII,MOT,RAY,HUG	211	TO 46	60	60	5.0	.600A	.360W	200J	200.000G	10NA	50V	160	.150A
2N3487	N	S	MOT	561	TO 61	80	60	10.0	7.500A	15.000W	200C	10.000G	100UA	80V	35	3.000A
2N3488	N	S	MOT	561	TO 61	100	80	10.0	7.500A	115.000W	200C	10.000G	100UA	100V	35	3.000A
2N3489	N	S	MOT	561	TO 61	120	100	10.0	7.500A	115.000W	200C	10.000G	100UA	120V	26	3.000A
2N3490	N	S	MOT	561	TO 61	80	60	10.0	7.500A	115.000W	200C	10.000G	100UA	80V	70	5.000A
2N3491	N	S	MOT	561	TO 61	100	80	10.0	7.500A	115.000W	200C	10.000G	100UA	100V	70	5.000A
2N3492	N	S	MOT	561	TO 61	120	100	10.0	7.500A	115.000W	200C	10.000G	100UA	120V	52	5.000A
2N3493	N	S	MOT	217	TO 72	12	8	5.0	.500A	.150W	200J	400.000G	5NA	6V	70	.001A
2N3494	P	S	MOT,TII,TEC,HUG	210	TO 5	80	80	4.5	.100A	.600W	200J	200.000G	100NA	50V	80	.010A
2N3495	P	S	MOT,TII,TEC	210	TO 5	120	120	4.5	.100A	.600W	200J	200.000G	100NA	90V	80	.010A
2N3496	P	S	MOT,TII,TEC	210	TO 18	80	80	4.5	.100A	.400W	200J	200.000G	100NA	50V	80	.010A
2N3497	P	S	MOT,TII,TEC	210	TO 18	100	120	4.5	.100A	.400W	200J	150.000G	100NA	90V	80	.010A
2N3498	P	S	FSC,TRW,TEC,HUG	210	TO 10	100	100	1.0	.500A	1.360W	200J	200.000G	10NA	50V	70	.010A
2N3499	N	S	MOT,TRW,TEC,HUG	210	TO 5	100	100	6.0	.500A	1.000W	200J	150.000G	50NA	50V	180	.150A
2N3500	N	S	MOT,TEC	210	TO 5	150	150	6.0	.300A	1.000W	200J	150.000G	50NA	75V	70	.150A
2N3501	N	S	MOT,TEC	210	TO 5	150	150	6.0	.300A	1.000W	200J	150.000G	50NA	75V	180	.150A
2N3502	P	S	FSC,TII,RAY,ITT,NSC,TEC	211	TO 5	45	45	5.0	.600A	.700W	200J	200.000G	10NA	30V	150	.150A
2N3503	P	S	FSC,TII,RAY,ITT,NSC,TEC	211	TO 5	30	25	10.0	.600A	.400W	200J	200.000G	10NA	30V	150	.150A
2N3504	P	S	FSC,TII,RAY,ITT,NSC,TEC	211	TO 18	45	45	5.0	.600A	.400W	200J	200.000G	10NA	30V	150	.150A
2N3505	P	S	FSC,TII,RAY,ITT,NSC,TEC	211	TO 18	60	60	5.0	.600A	.400W	200J	200.000G	10NA	50V	150	.150A
2N3506	N	S	MOT,BEN,HUG	210	TO 5	60	40	5.0	3.000A	1.000W	200J	60.000G	1UA	40V	10	1.500A
2N3507	N	S	MOT,BEN,HUG	210	TO 5	60	50	5.0	3.000A	1.000W	200J	60.000G	1UA	60V	68	1.500A
2N3508	N	S	MOT	210	TO 46	40	20	6.0	.500A	.400W	200J	200.000G	20NA	50V	70	.001A
2N3509	N	S	MOT	210	TO 46	40	20	6.0	.500A	.400W	200J	50.000G	200NA	20V	180	.010A
2N3510	N	S	MOT,FSC	210	TO 52	40	10	6.0	.500A	.360W	200J	350.000G	25NA	10V	60	.150A
2N3511	N	S	MOT,FSC	210	TO 46	40	15	6.0	.500A	.360W	200J	450.000G	25NA	10V	68	.150A
2N3512A	N	S	MOT,TRW,TEC,HUG	211	TO 5	60	35	5.0	.500A	.800W	200J	250.000G	500NA	30V	20	.001A
2N3543	N	S	1MH	605	TO 3	155	60	4.0	5.000A	60.000W	175J	150.000G	10NA	50V	40	4.500A
2N3544	N	S	MOT	210	TO 18	25	25	3.0	.100A	.300W	175J	60.000G	100NA	15V	50	.010A
2N3545	P	S	RAY	211	TO 18	20	20	5.0	.360W	.200W	200J	250.000G	10NA	45V	70	.010A
2N3546	P	S	MOT,RAY	211	TO 18	15	12	4.5	.360W	.200W	200J	700.000G	10NA	10V	60	.010A
2N3547	P	S	NSC	210	TO 18	60	60	6.0	.100A	.400W	200J	45.000G	10NA	45V	225	.010A
2N3548	P	S	NSC	211	TO 18	60	45	6.0	.100A	.400W	200J	60.000G	10NA	45V	300	.010A
2N3549	P	S	NSC	211	TO 18	60	60	6.0	.100A	.400W	200J	60.000G	10NA	45V	400	.010A
2N3550	P	S	NSC	211	TO 18	60	45	6.0	.100A	.400W	200J	60.000G	10NA	45V	500	.010A
2N3551	N	S	TII	911	911A	115	60	7.0	12.000A	1.200W	175J	40.000G	10MA	110V	44	.001A
2N3552	N	S	TII	911	911A	140	80	7.0	12.000A	1.200W	175J	40.000G	10MA	135V	44	.001A
2N3553	N	S	SEE RF POWER SECTION													
2N3554	N	S	TII,RAY	173	TO 5	60	30	5.0	1.200A	.800W	200J	150.000G	500NA	40V	50	.750A
2N3563	N	S	FSC,NSC,GIC,TEC,HUG	211	TO106	30	12	2.0	.200W	.125J	125J	600.000G	50NA	30V	70	.008A
2N3564	N	S	FSC,NSC,GIC,HUG	211	TO106	30	15	4.0	.200W	.125J	125J	400.000G	100UA	30V	70	.015A
2N3565	N	S	FSC,NSC,GIC,TEC,PHF,HUG	173	TO105	30	25	1.0	.300W	.125J	125J	400.000G	50NA	30V	300	.001A
2N3566	N	S	FSC,NSC,PHF,HUG	173	TO105	40	30	5.0	.300W	.125J	125J	40.000G	50NA	40V	300	.010A
2N3567	N	S	FSC,NSC,HUG	173	TO105	80	40	5.0	.500A	.300W	125J	60.000G	50UA	40V	70	.120A
2N3568	N	S	FSC,HUG	173	TO105	80	60	5.0	.500A	.300W	125J	60.000G	50UA	40V	70	.120A
2N3569	N	S	FSC,FSC,HUG	173	TO105	80	40	5.0	.500A	.300W	125J	60.000G	50UA	40V	175	.300A
2N3570	N	S	TII	217	TO 72	20	15	2.0	.050A	.200W	200J	1500.000G	10NA	6V	58	.005A
2N3571	N	S	TII	217	TO 72	25	15	3.0	.050A	.200W	200J	1200.000G	10NA	6V	70	.005A
2N3572	N	S	TII	217	TO 72	25	13	3.0	.050A	.200W	200J	1000.000G	10NA	6V	95	.005A
2N3576	P	S	TII,RAY	211	TO 18	20	15	5.0	.200A	.360W	175J	400.000G	10NA	15V	70	.010A
2N3577	P	S	SOL,SSO,HUG	211	TO 46	80	60	6.0	.030A	.400W	200J	80.000G	50NA	40V	60	.001A
2N3580	P	S	SOL,SSO,HUG	211	TO 46	80	60	6.0	.030A	.400W	200J	80.000G	50NA	40V	130	.001A
2N3581	P	S	SOL,SSO,HUG	211	TO 46	50	40	6.0	.030A	.400W	200J	100.000G	20NA	30V	100	.001A
2N3582	P	S	SOL,SSD,HUG	211	TO 46	50	40	6.0	.030A	.400W	200J	100.000G	20NA	30V	200	.001A
2N3583	N	S	RCA	605	TO 66	250	175	6.0	5.000A	35.000W	200J	100.000G	1MA	225V	80	.100A
2N3584	N	S	RCA	605	TO 66	375	250	6.0	5.000A	35.000W	200J	100.000G	1MA	300V	80	.100A
2N3585	N	S	RCA	605	TO 66	500	300	6.0	5.000A	35.000W	200J	100.000G	1MA	400V	80	.100A
2N3588	P	S	AMP	218	218E	25	15	3.0	.010A	.100W	85J	270.000G	5UA	12V	66	.003A
2N3589	-N	S	GEC	635	635B	200	200R	10.0	15.000W	175J	15.000G	1UA	100V	50	200A	
2N3590	-N	S	GEC	635	635B	200	200	10.0	15.000W	175J	15.000G	1UA	100V	100	200A	
2N3591	-N	S	GEC	676	676A	200	200	10.0	15.000W	175J	15.000G	1UA	100V	50	200A	
2N3592	-N	S	GEC	676	676A	200	200	10.0	15.000W	175J	15.000G	1UA	100V	100	200A	
2N3593	-N	S	GEC	530	530B	200	200	10.0	7.000W	175J	15.000G	1UA	100V	50	200A	
2N3594	-N	S	GEC	530	530B	200	200	10.0	7.000W	175J	15.000G	1UA	100V	100	200A	
2N3595	-N	S	GEC	530	530A	200	200	10.0	15.000W	175J	15.000G	1UA	100V	50	200A	
2N3596	-N	S	GEC	530	530A	200	200R	10.0	15.000W	175J	15.000G	1UA	100V	100	200A	
2N3597	N	S	SOL,TEC,FSC,HUG	561	TO 63	80	40	8.0	20.000A	100.000W	200J	30.000G	100NA	30V	70	10.000A
2N3598	N	S	SOL,TEC,FSC,HUG	561	TO 63	80	60	8.0	20.000A	100.000W	200J	30.000G	100NA	30V	70	10.000A
2N3599	N	S	SOL,TEC,FSC,HUG	561	TO 63	100	80	8.0	20.000A	100.000W	200J	30.000G	100NA	30V	70	10.000A
2N3600	N	S	RCA,AMP	217	TO 72	30	15	3.0	.20							

Transistor Type No.	N P	G S	Manufacturer	Lead Ident	Out- line	Maximum (V)			Maximum		Max. T.(C)	Frequency Resp.(MHz)	Leakage I _{BR} @ V _{CE}	Gain h _{FE} @ I _C		
						V _{CE}	V _{CE}	V _{BE}	I _C	Power						
2N3634	P	S	MOT,TEC	211	To 5	140	140	5.0	1.000A	1.000W	200J	150.000G	100NA	100V	86	.050A
2N3635	P	S	MOT,TEC	211	To 5	140	140	5.0	1.000A	1.000W	200J	200.000G	100NA	100V	130	.050A
2N3636	P	S	MOT,TEC	211	To 5	175	175	5.0	1.000A	1.000W	200J	150.000G	100NA	100V	86	.050A
2N3637	P	S	MOT,TEC	211	To 5	175	175	5.0	1.000A	1.000W	200J	200.000G	100NA	100V	130	.050A
2N3638	P	S	FSC,GIC,NSC,HUG	170	170F	25	25	4.0	.500A	.300W	125J	100.000G	35NA	15V	67	.050A
2N3638A	P	S	FSC,NSC,HUG	170	170F	25	25	4.0	.500A	.300W	125J	150.000G	35NA	15V	130	.050A
2N3639	P	S	HUG	170	170F	12	12	4.0	.200W	.125W	250J	350.000G	50NA	3V	60	.100A
2N3640	P	S	HUG	170	170F	12	12	4.0	.200W	.125W	250J	400.000G	50NA	6V	60	.100A
2N3641	N	S	FSC,NSC,HUG	170	170F	60	30	5.0	.500W	.300W	125J	250.000G	50NA	50V	70	.100A
2N3642	N	S	FSC,NSC,HUG	170	170G	60	30	5.0	.500W	.300W	125J	250.000G	50NA	50V	70	.100A
2N3643	N	S	FSC,NSC,HUG	170	170G	60	45	5.0	.500W	.300W	125J	250.000G	50NA	50V	140	.100A
2N3644	N	S	NSC,FSC,HUG	173	To105	45	45	5.0	.500A	.300W	125J	200.000G	35NA	30V	175	.150A
2N3645	P	S	NSC,FSC,HUG	173	To105	60	60	5.0	.500A	.300W	125J	200.000G	35NA	50V	175	.150A
2N3646	N	S	FSC,HUG	211	To 170F	40	15	6.0	.200W	.125W	200J	400.000G	500NA	20V	60	.550A
2N3647	N	S	MOT,HUG	211	To 46	40	10	6.0	.500A	.400W	200J	450.000G	25NA	10V	60	.150A
2N3648	N	S	MOT,HUG	211	To 46	40	15	6.0	.500A	.400W	200J	450.000G	25NA	10V	60	.150A
2N3659	N	S	TRW,HUG	211	To 5	220	170	5.0	.500A	4.000W	200J	50.000G	10NA	120V	30	.010A
2N3660	P	S	TEC,HUG	211	To 5	40	30	5.0	1.500A	5.000W	200A	25.000G	100NA	20V	50	.500A
2N3661	P	S	TEC,HUG	211	To 5	60	50	5.0	1.500A	5.000W	200A	25.000G	100NA	30V	50	.500A
2N3662	N	S	GEC,SES	45	To 98	18	12	3.0	.025A	.200W	100J	700.000G	500NA	15V	40	.008A
2N3663	N	S	GEC,SES	45	To 98	30	12	3.0	.025A	.200W	100J	700.000G	500NA	15V	40	.008A
2N3665	N	S	ITT,NSC,TEC,HUG	211	To 5	120	80	10.0	1.000A	5.000W	200J	60.000G	50NA	60V	70	.150A
2N3666	N	S	ITT,NSC,TEC,HUG	211	To 5	120	80	10.0	1.000A	5.000W	200J	60.000G	50NA	60V	150	.150A
2N3667	N	S	STC,BEN	605	To 3	50	50	5.0	15.000A	117.000W	200J	5.000G	5MA	50V	8.000A	.001A
2N3671	P	S	FSC,RAY,ITT,MOT,HUG	211	To 5	60	50	5.0	.600A	.600W	200J	200.000G	10NA	50V	120	.150A
2N3672	P	S	FSC,RAY,ITT,MOT,HUG	211	To 18	60	50	5.0	.600A	.400W	200J	200.000G	10NA	50V	120	.150A
2N3673	P	S	FSC,RAY,ITT,MOT,HUG	211	To 46	60	50	5.0	.600A	.350W	200J	200.000G	10NA	50V	120	.150A
2N3675	N	S	HUG	211	To 5	90	50	7.0	3.000A	8.750W	200C	1.000G	5MA	80V	27	1.000A
2N3676	N	S	HUG	211	To 5	90	90	7.0	3.000A	8.750W	200C	1.000G	5MA	80V	27	1.000A
2N3678	N	S	FSC,ITT,TRW	211	To 5	75	55	6.0	.800A	.800W	200J	250.000G	10NA	60V	70	.150A
2N3681	N	S	RAY	217	To 72	10	7	2.0	.200W	.200W	200J	1000.000G	50NA	60V	100	.002A
2N3688	N	S	FSC,GIC	170	170F	40	40	4.0	.200W	.125W	250J	400.000G	50NA	20V	70	.004A
2N3689	N	S	FSC,GIC	170	170F	40	40	4.0	.200W	.125W	250J	400.000G	50NA	20V	70	.004A
2N3690	N	S	FSC,GIC	170	170F	40	40	4.0	.200W	.125W	250J	400.000G	50NA	20V	70	.004A
2N3691	N	S	FSC,NSC,PHF	170	170F	35	25	4.0	.200W	.125W	200J	200.000G	50NA	30V	80	.010A
2N3692	N	S	FSC,NSC,PHF,HUG	170	170F	35	25	4.0	.200W	.125W	200J	200.000G	50NA	30V	200	.010A
2N3693	N	S	FSC,NSC,PHF,HUG	170	170F	45	45	4.0	.200W	.125W	200J	200.000G	50NA	35V	80	.010A
2N3694	N	S	FSC,NSC,GIC	170	170F	45	45	4.0	.200W	.125W	200J	200.000G	50NA	30V	200	.010A
2N3700	N	S	RAY,TRW,TEC,HUG	211	To 18	140	80	7.0	1.000A	.500W	200J	100.000G	10NA	90V	160	.150A
2N3701	N	S	ITT,TEC,HUG	211	To 18	140	80	7.0	1.000A	.500W	200J	80.000G	10NA	90V	70	.150A
2N3702	P	S	TI	43	To 92	40	25	5.0	.200A	.360W	125J	100.000G	100NA	20V	150	.050A
2N3703	P	S	TI	43	To 92	30	50	5.0	.200A	.360W	125J	100.000G	100NA	20V	150	.050A
2N3704	N	S	TI	43	To 92	50	30	5.0	.800A	.360W	150J	100.000G	100NA	20V	160	.050A
2N3705	N	S	TI	43	To 92	50	30	5.0	.800A	.360W	150J	100.000G	100NA	20V	80	.050A
2N3706	N	S	TI	43	To 92	40	20	5.0	.800A	.360W	150J	100.000G	100NA	20V	300	.050A
2N3707	N	S	TI	43	To 92	30	30	6.0	.030A	.250W	125J	.200G	100NA	20V	200	.001A
2N3708-BLU	N	S	TI	43	To 92	30	30	6.0	.030A	.250W	125J	.200G	100NA	20V	88	.001A
2N3708-BRN	N	S	TI	43	To 92	30	30	6.0	.030A	.250W	125J	.090G	100NA	20V	65	.001A
2N3708-GRN	N	S	TI	43	To 92	30	30	6.0	.030A	.250W	125J	.090G	100NA	20V	250	.001A
2N3708-ORG	N	S	TI	43	To 92	30	30	6.0	.030A	.250W	125J	.090G	100NA	20V	128	.001A
2N3708-RED	N	S	TI	43	To 92	30	30	6.0	.030A	.250W	125J	.090G	100NA	20V	88	.001A
2N3708-VIO	N	S	TI	43	To 92	30	30	6.0	.030A	.250W	125J	.090G	100NA	20V	510	.001A
2N3708-YEL	N	S	TI	43	To 92	30	30	6.0	.030A	.250W	125J	.090G	100NA	20V	178	.001A
2N3709	N	S	TI	43	To 92	30	30	6.0	.030A	.250W	125J	.090G	100NA	20V	80	.001A
2N3710	N	S	TI	43	To 92	30	30	6.0	.030A	.250W	125J	.180G	100NA	20V	160	.001A
2N3711	N	S	TI	43	To 92	30	30	6.0	.030A	.250W	125J	.180G	100NA	20V	160	.001A
2N3712	N	S	TI,MOT	211	To 5	150	150	5.0	.200A	.800W	175J	40.000G	100NA	75V	70	.030A
2N3713	P	S	MOT,TI	605	To 3	80	60	7.0	10.000A	150.000W	200J	4.000G	1MA	80V	48	1.000A
2N3714	P	S	MOT,TI	605	To 3	100	80	7.0	10.000A	150.000W	200J	4.000G	1MA	100V	48	1.000A
2N3715	P	S	MOT,TI	605	To 3	60	60	7.0	10.000A	150.000W	200J	4.000G	1MA	80V	86	1.000A
2N3716	N	S	MOT,TI	605	To 3	100	80	7.0	10.000A	150.000W	200J	4.000G	1MA	100V	86	1.000A
2N3719	P	S	MOT,TEC	211	To 5	40	40	4.0	3.000A	1.000W	200J	60.000G	10UA	40V	70	1.000A
2N3720	P	S	MOT,TEC	211	To 5	60	60	4.0	3.000A	1.000W	200J	60.000G	10UA	60V	70	1.000A
2N3721	N	S	SPR	45	To 98	18	18	5.0	.100A	.360W	150J	AUD	500NA	18V	160	.002A
2N3722	N	S	FSC,GEC,RAY,MOT	211	To 5	80	60	6.0	1.000A	.800W	200J	300.000G	500NA	40V	70	.100A
2N3723	N	S	FSC,GEC,MOT	211	To 5	100	80	6.0	1.000A	.800W	200J	300.000G	500NA	40V	70	.100A
2N3724	N	S	FSC,ITI,TEC,RAY,IMH	211	To 5	50	30	6.0	1.000A	.800W	200J	250.000G	2UA	40V	60	.010A
2N3724A	N	S	ITI,RAY	211	To 5	50	30	6.0	1.200A	1.000W	200J	300.000G	500NA	40V	98	.100A
2N3725	N	S	FSC,ITI,TEC,RAY,IMH	211	To 5	80	50	6.0	1.000A	.800W	200J	250.000G	2UA	60V	60	.010A
2N3725A	N	S	ITI,RAY	211	To 5	80	50	6.0	1.200A	1.000W	200J	300.000G	500NA	60V	98	.100A
2N3730	P	G	RCA	605	To 3	200	50	5.0	3.000A	10.000W	85J	.015G	200UA	10V	98	1.000A
2N3731	P	G	RCA	605	To 3	320	20	2.0	10.000A	5.000W	85J	.015G	200UA	10V	98	1.000A
2N3732	P	G	RCA	605	To 3	100	50	5.0	3.000A	3.000W	85J	.015G	200UA	10V	98	1.000A
2N3733	N	S	SEE RF POWER SECTION													
2N3734	N	S	MOT,FSC,RAY	211	To 5	50	30	5.0	1.500A	1.000W	200J	250.000G	20NA	25V	60	1.000A
2N3735	N	S	MOT,RAY	211	To 5	75	50	5.0	1.500A	.500W	200J	250.000G	20NA	40V	40	1.000A
2N3736	N	S	MOT,FSC,ITI	211	To 46	50	30	5.0	1.500A	1.000W	200J	250.000G	20NA	25V	60	1.000A
2N3737	N	S	MOT,FSC	211	To 46	75	50	5.0	1.500A	.500W	200J	250.000G	20NA	40V	40	1.000A
2N3738	N	S	MOT,FSC	605	To 66	250	225	6.0	.250A	20.000W	175J	10.000G	100UA	250V	100	1.00A
2N3739	N	S	MOT,FSC	605	To 66	325	300	6.0	.250A	20.000W	175J	10.000G	100UA	320V	100	1.00A
2N3740	P	S	MOT,TEC,FSC	605	To 66	60	60	7.0	4.000A	25.000W	200J	4.000G	100UA	60V	50	2.50A
2N3740A	P	S	MOT	605	To 66	60	60	7.0	4.000A	25.000W	200J	4.000G	100UA	60V	55	2.50A
2N3741	P	S	MOT,TEC,FSC	605	To 66	80	70	7.0	4.000A	25.000W	200J					

Transistor Type No.	N P	G S	Manufacturer	Lead Ident	Out- line	Maximum (V)			Maximum		Max. T. ^o (C)	Frequency Resp.(MHz)	Leakage I _{BR} @ V _{CB}	Gain h _{FE} @ I _C		
						V _{CE}	V _{ES}	V _{ES}	I _C	Power						
2N3779	P	S	STC	211	To 5	60	60	8.0	1.000A	8.750W	200J	HF AMP	500UA	60V	20	.200A
2N3780	P	S	STC	211	To 5	80	80	8.0	1.000A	8.750W	200J	HF AMP	500UA	80V	20	.200A
2N3781	P	S	STC	211	To 5	100	100	8.0	1.000A	8.750W	200J	HF AMP	500UA	100V	20	.200A
2N3782	P	S	STC	211	To 5	40	40	8.0	1.000A	8.750W	200J	HF AMP	500UA	40V	20	1.000A
2N3783	P	S	MOT	217	To 72	30	30S	20.0	.020A	.150W	100J	800.000G	SUA	10V	75	.003A
2N3784	P	S	MOT	217	To 72	30	30S	20.0	.020A	.150W	100J	800.000G	SUA	10V	70	.003A
2N3785	P	S	MOT	217	To 72	15	15S	12.0	.020A	.150W	100J	700.000G	SUA	10V	66	.003A
2N3788	N	S	BEN_MOT	605	To 3	400	325	5.0	3.000A	100.000W	200J	4.000G	1MA	60V	6	2.500A
2N3789	N	S	MOT_FSC	605	To 3	60	60	7.0	10.000A	150.000W	200J	4.000G	1MA	60V	50	1.000A
2N3790	N	S	MOT_FSC	605	To 3	80	80	7.0	10.000A	150.000W	200J	4.000G	1MA	80V	80	1.000A
2N3791	N	S	MOT_FSC	605	To 3	60	60	7.0	10.000A	150.000W	200J	4.000G	1MA	80V	80	1.000A
2N3792	N	S	MOT_FSC	605	To 3	80	80	7.0	10.000A	150.000W	200J	4.000G	1MA	80V	80	1.000A
2N3793	N	S	NSC	51	51A	40	20	5.0	.500A	.250W	125J	100.000G	500NA	15V	50	.010A
2N3794	N	S	NSC	51	51A	40	20	5.0	.500A	.250W	125J	100.000G	500NA	15V	250	.010A
2N3798	N	S	MOT_TII	211	To 18	60	60	5.0	.050A	.360W	200J	100.000G	10NA	50V	260	.001A
2N3799	N	S	MOT_TII	211	To 18	60	60	5.0	.050A	.360W	200J	100.000G	10NA	50V	570	.001A
2N3818	N	S	MOT_TII	540	To 60	60	60	4.0	1.000A	25.000W	175J	150.000G	1UA	50V	17	.400A
2N3826	N	S	TII	168	168A	60	45	4.0	.030A	.200W	125J	200.000G	100NA	30V	80	.010A
2N3827	N	S	TII	168	168A	60	45	4.0	.030A	.200W	125J	200.000G	100NA	30V	200	.010A
2N3828	N	S	TII	43	To 92	40	40	3.0	.100A	.300W	125J	360.000G	10NA	20V	100	.012A
2N3829	N	S	TII	211	To 5	2	2	5.0	.500A	.360W	175J	300.000G	300NA	20V	60	.030A
2N3830	N	S	TII_RAY	211	To 5	80	50	4.0	1.200A	1.000W	200J	200.000G	500NA	40V	30	.500A
2N3831	N	S	TII_RAY	211	To 5	70	40	5.0	1.200A	1.000W	200J	200.000G	500NA	40V	35	.500A
2N3832	N	S	TII	217	To 72	15	10	6.0	.035A	.200W	200J	800.000G	10NA	8V	60	.002A
2N3839	N	S	RCA_MOT	217	To 72	30	15	2.5	.040A	.200W	200J	1000.000G	10NA	68	.003A	
2N3840	N	S	GE_C,SPR,MOT,HUG	210	To 46	60	30	4.0	1.00A	.360W	100J	90.000G	1MA	40V	75	.00A
2N3841	N	S	NSC_HUG	210	To 18	100	100	80.0	.100A	.300W	175J	1.500G	2NA	50V	40	.001A
2N3842	N	S	NSC_HUG	210	To 18	120	120	120.0	.100A	.300W	175J	1.000G	20NA	50V	20	.001A
2N3843	N	S	GE_C,SPR,HUG	45	To 98	30	30	4.0	.100A	.200W	100J	60.000G	500NA	18V	30	.02A
2N3843A	N	S	GE_C,SPR,HUG	45	To 98	30	30	4.0	.100A	.200W	100J	60.000G	500NA	18V	30	.02A
2N3844	N	S	GE_C,SPR,HUG	45	To 98	30	30	4.0	.100A	.200W	100J	60.000G	500NA	18V	30	.02A
2N3844A	N	S	GE_C,SPR,HUG	45	To 98	30	30	4.0	.100A	.200W	100J	90.000G	500NA	18V	52	.002A
2N3845	N	S	GE_C,SPR,HUG	45	To 98	30	30	4.0	.100A	.200W	100J	120.000G	500NA	18V	90	.002A
2N3845A	N	S	GE_C,SPR,HUG	45	To 98	30	30	4.0	.100A	.200W	100J	120.000G	500NA	18V	90	.002A
2N3846	N	S	TII	560	To 63	300	200	10.0	20.000A	150.000W	175C	10.000G	2MA	300V	25	10.000A
2N3847	N	S	TII	560	To 63	400	300	10.0	20.000A	150.000W	175C	10.000G	2MA	300V	25	10.000A
2N3850	N	S	SSP_TEC_BEN	561	To 59	80	80	4.0	30.000W	3.000W	200J	40.000G	100NA	80V	20	2.000A
2N3851	N	S	SSP_TEC_BEN	561	To 59	100	80	4.0	30.000W	3.000W	200J	30.000G	100NA	80V	20	2.000A
2N3852	N	S	SSP_BEN_TEC	561	To 59	60	40	4.0	30.000W	3.000W	200J	40.000G	100NA	40V	30	2.000A
2N3853	N	S	SSP_TEC_BEN	561	To 59	60	40	4.0	30.000W	3.000W	200J	30.000G	100NA	40V	20	2.000A
2N3854	N	S	GE_C,SPR,SES,HUG	45	To 98	18	18	4.0	.100A	.200W	100J	100.000G	500NA	18V	50	.002A
2N3854A	N	S	GE_C,SPR,SES,HUG	45	To 98	18	18	4.0	.100A	.200W	100J	100.000G	500NA	18V	50	.002A
2N3855	N	S	GE_C,SPR,SES,HUG	45	To 98	18	18	4.0	.100A	.200W	100J	130.000G	500NA	18V	80	.002A
2N3855A	N	S	GE_C,SPR,SES,HUG	45	To 98	30	30	4.0	.100A	.200W	100J	130.000G	500NA	18V	80	.002A
2N3856	N	S	GE_C,SPR,SES,HUG	45	To 98	18	18	4.0	.100A	.200W	100J	140.000G	500NA	18V	140	.002A
2N3856A	N	S	GE_C,SPR,SES,HUG	45	To 98	30	30	4.0	.100A	.200W	100J	140.000G	500NA	18V	140	.002A
2N3857	N	S	NSC	210	To 5	45	45	30.0	.500A	.600W	200J	4.000G	5NA	40V	100	.001A
2N3858	N	S	GE_C,SPR,HUG	45	To 98	30	30	4.0	.100A	.120W	100J	90.000G	500NA	18V	80	.002A
2N3858A	N	S	GE_C,SPR,HUG	45	To 98	60	60	4.0	.100A	.120W	100J	90.000G	100NA	60V	80	.002A
2N3859	N	S	GE_C,SPR,HUG	45	To 98	30	30	4.0	.100A	.120W	100J	90.000G	500NA	18V	140	.002A
2N3859A	N	S	GE_C,SPR,HUG	45	To 98	60	60	4.0	.100A	.120W	100J	90.000G	100NA	60V	140	.002A
2N3860	N	S	GE_C,SPR,HUG	45	To 98	30	30	4.0	.100A	.120W	100J	90.000G	500NA	18V	200	.002A
2N3862	N	S	TEC	211	To 18	50	20	4.5	.200A	.360W	300J	600.000G	50NA	20V	88	.010A
2N3863	N	S	STC	605	To 3	70	50	7.0	7.500A	117.000W	200C	.500G	1MA	50V	52	3.000A
2N3864	N	S	STC_BEN	605	To 3	110	80	7.0	7.500A	117.000W	200C	.500G	1MA	90V	52	3.000A
2N3865	N	S	STC_BEN	605	To 3	160	150	7.0	7.500A	117.000W	200C	.500G	1MA	150V	52	3.000A
2N3866	N	S	SEE RF POWER													
2N3867	P	S	TEC_MOT	211	To 5	45	40	4.0	3.000A	1.000W	200A	60.000G	1UA	40V	90	1.500A
2N3868	P	S	TEC_MOT	211	To 5	65	60	4.0	3.000A	1.000W	200A	60.000G	1UA	60V	68	1.500A
2N3877	N	S	GE_C,SPR,HUG	45	To 98	70	40	4.0	.050A	.200W	100J	160.000G	500NA	70V	40	.002A
2N3877A	N	S	GE_C,SPR,HUG	45	To 98	85	85	4.0	.050A	.200W	100J	160.000G	500NA	70V	40	.002A
2N3878	N	S	RCA_TEC	605	To 66	120	75	7.0	7.000A	35.000W	200J	40.000G	5MA	40V	100	.500A
2N3879	N	S	RCA	605	To 66	120	75	7.0	7.000A	35.000W	200J	40.000G	5MA	40V	40	4.000A
2N3883	P	S	GE_C,SPR,HUG	211	To 5	25	15	3.0	.300A	.300W	100J	100.000G	100UA	15V	60	.200A
2N3900	N	S	GE_C,SPR,HUG	45	To 98	18	18	5.0	.100A	.120W	100J	160.000G	100NA	18V	360	.002A
2N3900A	N	S	GE_C,SPR,HUG	45	To 98	18	18	5.0	.100A	.120W	100J	160.000G	100NA	18V	300	.002A
2N3901	N	S	GE_C	45	To 98	18	18	5.0	.100A	.120W	100J	200.000G	10NA	15V	450	.002A
2N3902	N	S	OEL_BEN_MOT	605	To 3	400	400	5.0	3.500A	100.000W	150J	4.000G	250UA	40V	53	1.000A
2N3903	N	S	MOT	41	To 92	60	40	6.0	.200A	.310W	135J	250.000G	50NA	40V	100	.010A
2N3904	N	S	MOT	41	To 92	60	40	6.0	.200A	.310W	135J	300.000G	50NA	40V	100	.010A
2N3905	N	S	MOT	41	To 92	40	40	5.0	.200A	.310W	135J	300.000G	50NA	40V	100	.010A
2N3906	N	S	MOT	41	To 92	40	40	5.0	.200A	.310W	135J	250.000G	50NA	40V	160	.010A
2N3910	P	S	RAY_MOT,HUG	211	To 46	60	50	50.0	.500W	200J	4.000G	1NA	50V	80	.001A	
2N3911	P	S	RAY_MOT,HUG	211	To 46	60	40	40.0	.500W	200J	8.000G	1NA	40V	120	.001A	
2N3912	P	S	RAY_MOT,HUG	211	To 46	60	30	30.0	.500W	200J	10.000G	1NA	30V	180	.001A	
2N3913	P	S	RAY_HUG	210	To 18	60	50	40.0	.400W	200J	8.000G	1NA	50V	80	.001A	
2N3914	P	S	RAY_HUG	210	To 18	60	40	40.0	.400W	200J	8.000G	1NA	40V	120	.001A	
2N3915	P	S	RAY_HUG	210	To 18	60	30	30.0	.400W	200J	10.000G	1NA	30V	180	.001A	
2N3916	N	S	HUG	635	635B	150	150	5.0	.150A	5.000W	150J	50.000G	1MA	250V	90	.150A
2N3917	N	S	HUG	605	To 3	80	40	6.0	2.000A	20.000W	150J	50.000G	100UA	30V	60	1.000A
2N3918	N	S	HUG	605	To 3	120	60	6.0	2.000A	20.000W	150J	50.000G	1MA	80V	175	1.000A
2N3919	N	S	HUG	605	To 3	80	60	6.0	2.000A	20.000W	150J	80.000G	10UA	60V	85	2.000A
2N3920	N	S	HUG	605	To 3	120	60	6.0	2.000A	20.000W	150J	80.000G	10UA	60V	210	2.000A
2N3921																

Transistor Type No.	N G P S	Manufacturer	Lead Ident	Out- line	Maximum (V)			Maximum		Max. T.(°C)	Frequency Resp.(MHz)	Leakage		Gain h _{FE} @ I _C
					V _{CE}	V _{ES}	V _{ES}	I _C	Power			I _{CEO} @ V _{CE}	I _{CEO} @ I _C	
2N3977	P S	SPR,NSC,MOT	210	TO 46	15	10	15.0	.100A	.400W	200J	1.000G	1NA 15V	8C .005A	
2N3978	P S	SPR,NSC,MOT,HUG	210	TO 46	25	20	25.0	.100A	.400W	200J	1.000G	1NA 25V	6C .005A	
2N3979	P S	SPR,NSC,HUG	210	TO 46	40	35	40.0	.100A	.400W	200J	1.000G	1NA 40V	4C .005A	
2N3985	P H	III,TEC,BEN	568	TO 18	20	12	5	.100A	.300W	100J	600.000G	3UA 6V	24C .025A	
2N3986	N S	III,TEC,BEN	211	TO 5	100	80	8.0	5.000A	30.000W	200J	40.000G	5UA 90V	40 .1.000A	
2N3987	N S	III,TEC,BEN	568	TO 111	100	80	8.0	5.000A	30.000W	200J	40.000G	5UA 90V	14C 1.000A	
2N3988	N S	III,TEC,BEN	568	TO 111	100	80	8.0	5.000A	30.000W	200J	40.000G	5UA 90V	7C 1.000A	
2N4000	N S	III,BEN,TEC,HUG	211	TO 5	100	80	8.0	1.000A	1.000W	200J	40.000G	5UA 90V	# 0 1.000A	
2N4001	N S	III,TEC,HUG	581	TO 5	120	100	8.0	1.000A	1.000W	200J	40.000G	10UA 60V	# 0 .500A	
2N4002	N S	III,TEC,BEN,FSC	561	TO 63	100	80	8.0	30.000A	100.000W	200J	30.000G	1MA 90V	40 15.000A	
2N4004	N S	III,TEC,BEN,FSC	561	TO 63	120	100	8.0	30.000A	100.000W	200J	30.000G	1MA 110V	40 15.000A	
2N4005	N S	III,TEC,BEN,FSC	913	TO 913A	150	80	8.0	20.000A	40.000W	200J	30.000G	2MA 40V	6E 10.000A	
2N4006	N S	III,TEC,BEN,FSC	913	TO 913A	120	100	8.0	20.000A	40.000W	200J	30.000G	2MA 50V	6E 10.000A	
2N4007	N S	III,TEC,BEN,FSC	211	TO 46	10	6	10.0	.100A	.400W	200J	20.000G	1NA 10V	60 .001A	
2N4008	P S	TEC,MOT	211	TO 46	20	15	20.0	.100A	.400W	200J	15.000G	1NA 20V	45 .001A	
2N4012	N S	SEE RF POWER SECTION	211	TO 46	35	35	30.0	.100A	.400W	200J	15.000G	3NA 45V	30 .001A	
2N4013	N S	TEC,HUG,ITT	211	TO 18	50	30	6.0	1.000A	.360W	200J	300.000G	2UA 40V	90 .100A	
2N4014	N S	TEC,HUG,ITT	211	TO 18	80	50	6.0	1.000A	.360W	200J	300.000G	2UA 60V	90 .100A	
2N4026	P S	FSC	211	TO 18	60	60	5.0	1.000A	.500W	200J	100.000G	50NA 50V	70 .100A	
2N4027	P S	FSC	211	TO 18	60	60	5.0	1.000A	.500W	200J	100.000G	50NA 50V	70 .100A	
2N4028	P S	FSC	211	TO 18	60	60	5.0	1.000A	.500W	200J	150.000G	50NA 50V	175 .100A	
2N4029	P S	FSC	211	TO 18	60	60	5.0	1.000A	.500W	200J	150.000G	50NA 60V	175 .100A	
2N4030	P S	III,RAY,FSC,IMH	211	TO 5	60	60	5.0	1.000A	.800W	200J	100.000G	50NA 50V	70 .100A	
2N4031	P S	III,FSC,IMH	211	TO 5	80	80	5.0	1.000A	.800W	200J	100.000G	50NA 50V	70 .100A	
2N4032	P S	III,RAY,FSC,IMH	211	TO 5	60	60	5.0	1.000A	.800W	200J	150.000G	50NA 50V	70 .100A	
2N4033	P S	III,FSC,IMH	211	TO 5	80	80	5.0	1.000A	.800W	200J	150.000G	50NA 60V	175 .100A	
2N4034	P S	FSC,ITT,HUG	211	TO 18	40	40	5.0	.100A	.360W	200J	400.000G	15NA 30V	150 .010A	
2N4035	P S	FSC	211	TO 18	40	40	5.0	.100A	.360W	200J	450.000G	15NA 30V	200 .010A	
2N4036	P S	RCA	215	TO 9	90	65	7.0	1.000A	1.000W	200J	60.000G	2NA 60V	75 .150A	
2N4037	P S	RCA	210	TO 5	60	40	7.0	1.000A	1.000W	200J	60.000G	2NA 60V	112 .150A	
2N4040	N S	SEE RF POWER SECTION												
2N4041	N S	SEE RF POWER SECTION												
2N4046	N S	FSC,ITT,RAY,TEC,IMH	211	TO 5	50	30	6.0	.500A	.800W	200J	250.000G	2UA 40V	90 .100A	
2N4047	N S	FSC,ITT,RAY,TEC,IMH	211	TO 5	80	50	6.0	.500A	.800W	200J	250.000G	2UA 60V	90 .100A	
2N4048	P G	MOT,SOL	403	TO 68	45	30	25.0	60.000A	170.000W	110J	.002E	4MA 45V	90 15.000A	
2N4049	P G	MOT,SOL	403	TO 68	60	45	30.0	60.000A	170.000W	110J	.002E	4MA 60V	90 15.000A	
2N4050	P G	MOT,SOL	403	TO 68	75	60	40.0	60.000A	170.000W	110J	.002E	4MA 75V	90 15.000A	
2N4051	P G	MOT,SOL	403	TO 68	45	30	25.0	60.000A	170.000W	110J	.002E	4MA 45V	124 15.000A	
2N4052	P G	MOT,SOL	403	TO 68	60	45	30.0	60.000A	170.000W	110J	.002E	4MA 60V	124 15.000A	
2N4053	P G	MOT,SOL	403	TO 68	75	60	40.0	60.000A	170.000W	110J	.002E	4MA 75V	124 15.000A	
2N4054	N S	GEC	52	TO 52A	300	300	7.0	.100A	4.000W	150J	25.000G	100UA 300V	52 .050A	
2N4055	N S	GEC	52	TO 52A	250	250	7.0	.100A	4.000W	150J	25.000G	100UA 250V	52 .050A	
2N4056	N S	GEC	52	TO 52A	150	150	7.0	.100A	4.000W	150J	25.000G	100UA 150V	52 .050A	
2N4057	N S	GEC	52	TO 52A	150	150	7.0	.100A	4.000W	150J	25.000G	100UA 150V	52 .050A	
2N4058	N S	ITT	43	TO 92	30	30	6.0	.030A	.250W	125A	.100G	100NA 20V	200 .001A	
2N4059	P S	ITT	43	TO 92	30	30	6.0	.030A	.250W	125A	.045G	100NA 20V	210 .001A	
2N4060	P S	ITT	43	TO 92	30	30	6.0	.030A	.250W	125A	.045G	100NA 20V	170 .001A	
2N4061	P S	ITT	43	TO 92	30	30	6.0	.030A	.250W	125A	.180G	100NA 20V	350 .001A	
2N4062	N S	RCA	635	TO 635B	450	350	7.0	1.000A	10.000W	200J	8.000G	20UA 300V	80 .020A	
2N4063	N S	RCA	635	TO 635B	800	250	7.0	1.000A	10.000W	200J	8.000G	50UA 300V	80 .020A	
2N4064	N S	RCA	215	TO 11	150	80	5.0	2.00A	5.000W	175J	5.000G	50NA 120V	70 .030A	
2N4069	N S	RCA	215	TO 11	150	80	5.0	2.00A	5.000W	175J	5.000G	50NA 120V	70 .030A	
2N4070	N S	SOL,BEN,HUG	605	TO 3	120	100	8.0	10.000A	65.000W	200J	60.000G	100NA 60V	70 5.000A	
2N4071	N S	SOL,HUG	605	TO 3	200	150	8.0	10.000A	65.000W	200J	60.000G	100NA 100V	70 5.000A	
2N4072	N S	MOT	211	TO 18	40	20	4.0	.100A	.350W	200J	275.000G	100NA 15V	10 .025A	
2N4073	N S	MOT	211	TO 5	40	20	4.0	.100A	1.500W	200J	275.000G	100NA 15V	10 .025A	
2N4074	N S	RCA	211	TO 211L	40	40	8.0	3.00A	.400W	175J	50.000G	10NA 25V	150 .010A	
2N4075	N S	FSC	560	TO 59	100	80	5.0	3.00A	30.000W	200J	30.000G	100NA 60V	55 1.000A	
2N4076	N S	FSC	560	TO 59	100	80	5.0	3.00A	30.000W	200J	30.000G	100NA 60V	80 1.000A	
2N4077	P G	AMP	605	TO 605A	32	32	1.0	1.000A	7.500W	200J	1.000G	185 50V	50 .04A	
2N4078	P G	AMP	605	TO 605A	32	32	1.0	1.000A	7.500W	200J	1.000G	185 50V	50 .04A	
2N4080	N S	RAY,HUG	217	TO 72	20	15	3.0	.200W	.200W	200J	1000.000G	10NA 15V	40 .033A	
2N4081	N S	RCA	218	TO 104	40	40	3.0	.050A	.200W	200J	600.000G	20NA 10V	86 .022A	
2N4104	N S	ITT,GIC	211	TO 5	60	60	1.0	1.000A	.300W	175J	90.000G	10NA 45V	600 .001A	
2N4106	N S	BEN	605	TO 3	100	60	8.0	30.000A	150W	200J	80.000G	50NA 30V	140 2.000A	
2N4111	N S	BEN	605	TO 3	100	60	8.0	30.000A	150W	200J	80.000G	50NA 30V	140 2.000A	
2N4112	N S	BEN	605	TO 3	120	80	8.0	30.000A	150W	200J	70.000G	50NA 30V	140 2.000A	
2N4113	N S	BEN	605	TO 3	120	80	8.0	30.000A	150W	200J	70.000G	50NA 30V	140 2.000A	
2N4114	N S	FSC	560	TO 59	120	80	8.0	37.000W	200J	70.000G	10UA 60V	64 2.000A		
2N4115	N S	FSC	560	TO 59	120	80	8.0	37.000W	200J	70.000G	10UA 60V	140 2.000A		
2N4116	N S	FSC	560	TO 59	120	80	8.0	37.000W	200J	80.000G	10UA 60V	140 2.000A		
2N4121	P S	FSC,TEC,HUG	170	TO 170F	40	40	5.0	.100A	.200W	125J	450.000G	25NA 30V	150 .010A	
2N4122	P S	TEC,HUG	170	TO 170F	40	40	5.0	.100A	.200W	125J	450.000G	25NA 30V	200 .010A	
2N4123	N S	MOT	41	TO 92	30	30	15.0	2.00A	.310W	135J	250.000G	50NA 20V	80 .002A	
2N4124	N S	MOT	41	TO 92	30	25	5.0	2.00A	.310W	135J	300.000G	50NA 20V	200 .002A	
2N4125	N S	MOT	41	TO 92	30	30	4.0	2.00A	.310W	135J	200.000G	50NA 20V	80 .002A	
2N4126	P S	MOT	41	TO 92	25	25	4.0	2.00A	.310W	135J	250.000G	50NA 20V	200 .002A	
2N4127	N S	SEE RF POWER SECTION												
2N4128	N S	SEE RF POWER SECTION												
2N4130	N S	IMH	603	TO 3	90	80	4.0	12.000A	120.000W	175J	200.000G	10UA 80V	26 2.000A	
2N4131	N S	ITT	603	TO 3	90	80	4.0	5.000A	60.000W	175J	150.000G	10UA 80V	30 1.000A	
2N4132	N S	ITT	632	TO 37	90	80	5.0	6.00A	7.500W	175J	250.000G	10UA 80V	30 2.00A	
2N4133	N S	ITT	632	TO 37	90	80	5.0	6.00A	7.500W	175J	250.000G	10UA 80V	30 2.00A	
2N4134	N S	FSC	217	TO 72	30	30	3.0	2.00A	.200W	200J	350.000G	50NA 10V	80 .004A	
2N4135	N S	FSC	217	TO 72	30	30	3.0	2.00A	.200W	200J	425.000G	50NA 10V	80 .004A	
2N4137	N S	FSC,RAY	210	TO 18	40	20	4.5	2.00A	.360W	200J	500.000G	400NA 20V	66 .010A	
2N4138	N S	ITT	211	TO 46	30	30	15.0	2.00A	.300W	175J	20.000G	10NA 25V	100 .010A	
2N4140	N S	GIC,NSC,HUG	173	TO 106	60	30	5.0	2.00A	.300W	125J	250.000G	50NA 30V	75 .150A	
2N4141	N S	GIC,NSC,HUG	173	TO 106	60	30	5.0	2.00A	.300W	125J	200.000G	50NA 40V	175 .150A	
2N4142	P S	GIC,NSC,HUG	173	TO 106	60	40	5.0	2.00A	.300W	125J	200.000G	50NA 30V	175 .150A	
2N4143	P S	GIC,NSC,HUG	173	TO 106	60									

Transistor Type No.	M P	S /	Manufacturer	Lead Ident	Out- line	Maximum (V)			Maximum		Max. T.(°C)	Frequency Resp.(MHz)	Leakage I _{CEO} @ V _{CE}	Gain h _{FE} @ I _C		
						V _{CE}	V _{CE}	V _{BE}	I _C	Power						
2N4236	P	S	MOT,TEC,FSC	211	To 5	80	80	7.0	3.000A	1.000W	200J	3.000G	100UA	80V	66	.250A
2N4237	N	S	FSC,TEC,BEN,MOT,HUG	211	To 5	50	40	6.0	1.000A	.800W	200J	1.000G	100UA	50V	68	.250A
2N4238	N	S	FSC,TEC,BEN,MOT,HUG	211	To 5	80	60	6.0	1.000A	.800W	200J	1.000G	100UA	80V	68	.250A
2N4239	N	S	FSC,TEC,BEN,MOT,HUG	211	To 5	100	80	6.0	1.000A	.800W	200J	1.000G	100UA	100V	68	.250A
2N4240	N	S	RCA	605	To 66	500	300	0.0	2.000A	35.000W	200J	15.000G	5MA	150V	70	.750A
2N4241	P	G	AMP,BEN	605	To 3	32	20	20.0	5.000A	37.500W	100C	.005E	45UA	1V	132	.300A
2N4242	P	G	SOL,HUG	605	To 3	80	70S	40.0	10.000A	106.000W	110J	.300G	2MA	80V	60	5.000A
2N4243	P	G	SOL,HUG	605	To 3	60	55S	30.0	10.000A	106.000W	110J	.300G	2MA	60V	60	5.000A
2N4244	P	G	SOL,HUG	605	To 3	80	70S	40.0	10.000A	106.000W	110J	.300G	2MA	80V	60	5.000A
2N4245	P	G	SOL,HUG	605	To 3	80	70S	40.0	10.000A	106.000W	110J	.300G	2MA	80V	90	5.000A
2N4246	P	G	SOL,HUG	605	To 3	60	55S	30.0	10.000A	106.000W	110J	.300G	2MA	60V	90	5.000A
2N4247	P	G	SOL,HUG	605	To 3	40	40S	20.0	10.000A	106.000W	110J	.300G	2MA	40V	90	5.000A
2N4248	P	S	FSC,NSC,GIC	170	To 170F	40	40	5.0	.200A	.200W	125J	40.000G	10NA	40V	120	.010A
2N4249	P	S	FSC,NSC,GIC	170	To 170F	60	60	5.0	.200A	.200W	125J	40.000G	10NA	40V	280	.010A
2N4250	P	S	FSC,NSC,GIC,HUG	170	To 170F	40	40	5.0	.200A	.200W	125J	50.000G	10NA	40V	350	.010A
2N4251	N	S	FSC	211	To 46	15	10	4.5	.250A	.200W	200J	1300.000G	1UA	10V	180	.010A
2N4252	N	S	TI1	217	To 72	30	18	4.0	.050A	.200W	175A	600.000G	50NA	15V	100	.002A
2N4253	N	S	TI1	217	To 72	30	18	4.0	.050A	.200W	175A	600.000G	50NA	15V	68	.002A
2N4254	N	S	TI1	43	To 92	30	18	4.0	.050A	.200W	125A	600.000G	100NA	15V	100	.002A
2N4255	N	S	TI1	43	To 92	30	18	4.0	.050A	.200W	125A	600.000G	100NA	15V	68	.002A
2N4256	N	S	GEC	45	To 98	30	30S	5.0	.100A	.200W	100J	100.000G	1NA	30V	220	.002A
2N4257	P	S	FSC	173	To 106	6	6	4.5	.050A	.200W	125J	600.000G	10NA	3V	60	.010A
2N4258	P	S	FSC	173	To 106	12	12	5.0	.050A	.200W	125J	700.000G	6V	6V	60	.010A
2N4259	P	S	RCA	217	To 104	40	30	2.5	.175A	.175W	175J	1000.000G	10NA	15V	122	.002A
2N4260	P	S	MOT	217	To 72	15	15	4.5	.030A	.200W	200J	1200.000G	5NA	10V	68	.010A
2N4261	P	S	MOT	217	To 72	15	15	4.5	.030A	.200W	200J	1500.000G	5NA	10V	68	.010A
2N4262	N	S	TI1	41	To 92	30	15	6.0	.310A	.310W	110J	300.000G	100NA	12V	200	.010A
2N4265	N	S	MOT	41	To 92	30	12	6.0	.200A	.310W	135J	300.000G	100NA	12V	200	.010A
2N4269	N	S	TEC,HUG	211	To 18	200	140	15.0	.030A	.360W	200**	**UD	1UA	150V	90	.010A
2N4270	N	S	TEC,HUG	210	To 5	200	140	15.0	.030A	.400W	200J	AUD	1UA	150V	90	.010A
2N4271	N	S	TEC,HUG	211	To 5	175	140	8.0	1.000A	5.000W	175C	20.000G	50NA	30V	55	.200A
2N4272	N	S	TEC,HUG	211	To 5	175	140	8.0	2.500A	5.000W	175C	10.000G	100NA	50V	55	1.000A
2N4273	N	S	TEC,HUG	605	To 66	175	140	9.0	2.500A	25.000W	175C	10.000G	100NA	50V	5	1.000A
2N4274	P	S	FSC,NSC,TEC,HUG	170	To 170F	30	15	4.5	.100A	.280W	125J	400.000G	10UA	20V	66	.010A
2N4275	N	S	FSC,NSC,TEC,HUG	170	To 170F	40	12	4.5	.100A	.280W	125J	400.000G	10UA	20V	66	.010A
2N4276	P	G	MOT	605	To 3	30	20	20.0	60.000A	170.000W	110J	.002E	4MA	30V	90	15.000A
2N4277	P	G	MOT	605	To 3	40	20	20.0	60.000A	170.000W	110J	.002E	4MA	30V	90	15.000A
2N4278	P	G	MOT	605	To 3	45	30	25.0	60.000A	170.000W	110J	.002E	4MA	45V	90	15.000A
2N4279	P	G	MOT	605	To 3	45	30	25.0	60.000A	170.000W	110J	.002E	4MA	45V	124	15.000A
2N4280	P	G	MOT	605	To 3	60	45	30.0	60.000A	170.000W	110J	.002E	4MA	60V	90	15.000A
2N4281	P	G	MOT	605	To 3	60	45	30.0	60.000A	170.000W	110J	.002E	4MA	60V	124	15.000A
2N4282	P	G	MOT	605	To 3	75	40	40.0	60.000A	170.000W	110J	.002E	4MA	75V	90	15.000A
2N4283	P	G	MOT	605	To 3	75	60	40.0	60.000A	170.000W	110J	.002E	4MA	75V	124	15.000A
2N4284	P	S	NSC	51	To 51A	25	25	25.0	.050A	.250W	150J	7.000G	100NA	10V	73	.001A
2N4285	P	S	NSC	51	To 51A	35	35	25.0	.050A	.250W	150J	7.000G	10NA	10V	73	.001A
2N4286	P	S	NSC	51	To 51A	30	20	5.0	.600A	.250W	150J	40.000G	50NA	10V	300	.010A
2N4287	N	S	NSC	51	To 51A	45	45	7.0	.100A	.250W	150J	40.000G	10NA	30V	300	.001A
2N4288	P	S	NSC	51	To 51A	30	25	6.0	.100A	.250W	150J	40.000G	50NA	25V	300	.001A
2N4289	P	S	NSC	51	To 51A	60	45	7.0	.100A	.250W	150J	40.000G	10NA	45V	300	.001A
2N4290	P	S	NSC	51	To 51A	30	20	5.0	.600A	.250W	150J	40.000G	50NA	10V	300	.010A
2N4291	P	S	NSC	51	To 51A	40	30	6.0	.600A	.250W	150J	100.000G	200NA	30V	175	.100A
2N4292	N	S	NSC	51	To 51A	30	15	3.0	.050A	.200W	150J	600.000G	500NA	15V	30	.003A
2N4293	N	S	NSC	51	To 51A	30	15	3.0	.050A	.200W	150J	600.000G	500NA	15V	30	.003A
2N4294	N	S	NSC	605	To 66	500	350	4.0	1.000A	20.000W	175J	20.000G	400NA	20V	88	.010A
2N4295	N	S	NSC	605	To 66	500	350	4.0	1.000A	20.000W	175J	20.000G	100NA	50V	70	.010A
2N4296	N	S	RCA	605	To 66	350	250	4.0	1.000A	20.000W	175J	20.000G	100UA	350V	80	.050A
2N4297	N	S	RCA	605	To 66	350	250	4.0	1.000A	20.000W	175J	20.000G	100UA	350V	100	.050A
2N4298	N	S	RCA	605	To 66	500	350	4.0	1.000A	20.000W	175J	20.000G	100UA	500V	30	.050A
2N4299	N	S	RCA	605	To 66	500	350	4.0	1.000A	20.000W	175J	20.000G	100UA	500V	80	.050A
2N4300	N	S	TI1,BEN,TEC,FSC,HUG	211	To 5	100	80	8.0	2.000A	15.000W	200J	30.000G	1UA	40V	60	1.000A
2N4301	N	S	TI1,TEC,BEN,FSC	561	To 61	100	80	8.0	10.000A	50.000W	200J	40.000G	10UA	40V	60	5.000A
2N4305	N	S	TRW,HUG	211	To 5	120	80	6.0	5.000A	1.500W	200J	100.000G	10UA	120V	88	1.000A
2N4306	N	S	TRW	905	To 905A	120	80	6.0	5.000A	30.000W	200J	100.000G	10UA	100V	88	1.000A
2N4307	N	S	TRW,HUG	905	To 905A	100	60	6.0	5.000A	30.000W	200J	100.000G	10UA	100V	88	1.000A
2N4308	N	S	TRW	905	To 905A	100	60	6.0	5.000A	30.000W	200J	100.000G	10UA	100V	88	1.000A
2N4309	N	S	TRW,HUG	211	To 5	120	80	6.0	5.000A	.500W	200J	100.000G	10UA	120V	88	1.000A
2N4310	N	S	TRW	905	To 905A	120	80	6.0	5.000A	30.000W	200J	100.000G	10UA	120V	70	1.000A
2N4311	N	S	TRW,HUG	905	To 905A	100	60	6.0	5.000A	1.250W	200J	100.000G	10UA	100V	88	1.000A
2N4312	N	S	TRW	905	To 905A	100	60	6.0	5.000A	30.000W	200J	100.000G	10UA	100V	70	1.000A
2N4313	P	S	FSC	173	To 106	12	12	4.5	.100A	.200W	125J	700.000G	50NA	10V	55	.100A
2N4314	P	S	RCA	211	To 5	90	65	7.0	1.000A	1.000W	200J	60.000G	250NA	60V	112	.150A
2N4346	P	G	RCA	605	To 3	320	240	2.0	10.000A	5.000W	85J	HORAMP	200UA	10V	25	6.000A
2N4347	N	S	RCA	605	To 3	140	120	7.0	5.000A	100.000W	200J	AUD	2MA	120V	38	2.000A
2N4348	N	S	RCA,MOT	605	To 3	140	120	7.0	10.000A	120.000W	200J	AUD	2MA	120V	30	5.000A
2N4350			SEE RF POWER SECTION													
2N4354	P	S	FSC	173	To 173A	60	60	5.0	.500A	.350W	125J	100.000G	50NA	50V	175	.010A
2N4355	P	S	FSC	173	To 173A	60	60	5.0	.500A	.350W	125J	100.000G	50NA	50V	200	.010A
2N4356	P	S	FSC	173	To 173A	80	80	5.0	.500A	.350W	125J	100.000G	50NA	50V	112	.010A
2N4357	P	S	FSC	211	To 18	240	240	6.0	.100A	.400W	200J	40.000G	20NA	200V	155	.010A
2N4358	P	S	FSC	211	To 39	240	240	6.0	.100A	.700W	200J	40.000G	20NA	200V	155	.010A
2N4359	P	S	FSC,HUG	211	To 18	45	45	5.0	.050A	.360W	200J	20.000G	10NA	25V	200	.010A
2N4383	N	S	SPR,HUG	210	To 5	40	30	5.0	.800A	.500W	200J	30.000G	10NA	30V	80	.010A
2N4384	N	S	SPR,HUG	210	To 18	40	30	5.0	.800A	.500						

Transistor Type No.	N P S	G P S	Manufacturer	Lead Ident	Out- line	Maximum (V) V _{CE} , V _{BE} , V _{ES}	Maximum I _C , Power	Max. T _C (°C)	Frequency Resp.(MHz)	Leakage I _{CE} @ V _{CE}	Gain h _{FE} @ I _C
2N4415	P	S	SPR,HUG	210	TO 18	40 30 5.0	.600A .400W	200J	20.000G	10NA 30V	200 .001A
2N4415A	P	S	SPR,HUG	210	TO 18	60 30 5.0	.600A .400W	200J	20.000G	10NA 30V	200 .001A
2N4418	N	S	TI	168	168A	40 15 4.5	.200A .250W	125J	500.000G	400NA 20V	70 .010A
2N4419	N	S	TI	168	168A	30 12 4.5	.200A .250W	125J	400.000G	400NA 20V	60 .010A
2N4420	N	S	TI	168	168A	40 20 5.0	.200A .250W	125J	350.000G	500NA 20V	60 .030A
2N4421	N	S	TI	168	168A	30 12 5.0	.200A .250W	125J	300.000G	500NA 20V	50 .030A
2N4422	N	S	TI	168	168A	40 15 5.0	.200A .250W	125J	350.000G	500NA 20V	60 .030A
2N4423	P	S	TI	168	168A	12 12 4.0	.200A .250W	200J	400.000G	80NA 6V	30 .030A
2N4424	N	S	SPR,GEC,HUG	45	TO 98	40 40 5.0	.500A .360W	150J		100NA 40V	312 .002A
2N4425	N	S	SPR,GEC,HUG	45	95B	40 40 5.0	.500A .560W	150J		100NA 40V	312 .002A
2N4427			SEE RF POWER SECTION								
2N4428			SEE RF POWER SECTION								
2N4429			SEE RF POWER SECTION								
2N4430			SEE RF POWER SECTION								
2N4431			SEE RF POWER SECTION								
2N4433	N	S	AMP	218	TO 72	60 50	.030A .165W		200.000G		8
2N4436	N	S	FSC	173	TO106	60 30 5.0	.500A .200W	125J	250.000G	50NA 50V	70 .150A
2N4437	N	S	FSC	173	TO106	60 30 5.0	.500A .200W	125J	250.000G	50NA 50V	175 .150A
2N4438	N	S	FSC	211	TO 39	300 300 8.0	.200A 1.000W	200J	30.000G	1UA 200V	160 .050A
2N4439	N	S	FSC	211	TO 39	300 300 8.0	.200A 1.000W	200J	30.000G	1UA 200V	70 .050A
2N4440			SEE RF POWER SECTION								
2N4862	N	S	SOL,HUG	211	TO 46	140 120 8.0	2.000A 4.000W	200J	50.000G	100NA 60V	88 .500A
2N4863	N	S	SOL,HUG	211	TO 5	140 120 8.0	2.000A 4.000W	200J	50.000G	100NA 60V	88 .500A
2N4864	N	S	SOL,TEC,HUG	605	TO 66	140 120 8.0	2.000A 16.600W	200J	50.000G	100NA 60V	88 .500A
2N4865	N	S	SOL,TEC,HUG	561	TO114	100 80 8.0	90.000A 200.000W	200J		1UA 60V	20 70.000A
2N4866	P	S	TOT,TEC,HUG	561	TO114	140 120 8.0	90.000A 200.000W	200J		10NA 60V	20 70.000A
2N4872	N	S	FSC	211	TO 18	12 12 4.5	.050A .300W	200J	900.000G	100NA 20V	1.0
2N4873	N	S	FSC	211	TO 18	40 15 4.5	.200A .360W	200J	700.000G	400NA 20V	1.0
2N4874			SEE RF POWER SECTION								
2N4875			SEE RF POWER SECTION								
2N4876			SEE RF POWER SECTION								
2N4877	N	S	MOT,FSC	211	TO 39	70 60 5.0	4.000A 10.000W	200J	4.000G	100UA 70V	45 4.000A
2N4888	P	S	FSC	173	173A	150 150 6.0	.300W 125J		30.000G	50NA 100V	15 .010A
2N4889	P	S	FSC	173	173A	150 150 6.0	.300W 125J		40.000G	10NA 100V	150 .010A
2N4890	N	S	MOT	211	TO 39	60 40 5.0	.700A 1.000W	200J	100.000G	250NA 60V	110 .150A
2N4895	N	S	FSC,BEN,HUG	211	TO 39	120 60 6.0	5.000A .800W	200J	50.000G	100UA 40V	75 2.000A
2N4896	N	S	FSC,BEN,HUG	211	TO 39	120 60 6.0	5.000A .800W	200J	80.000G	1UA 60V	150 2.000A
2N4897	N	S	FSC,BEN,HUG	211	TO 39	150 80 6.0	5.000A .800W	200J	50.000G	1UA 100V	75 2.000A
2N4898	N	S	MOT,FSC	605	TO 66	40 40 5.0	4.000A 25.000W	200J	3.000G	100UA 40V	46 .500A
2N4899	N	S	MOT,FSC	605	TO 3	60 60 5.0	10.000A 150.000W	200J	3.000G	100UA 60V	46 .500A
2N4900	P	S	MOT,FSC	605	TO 66	80 80 5.0	4.000A 25.000W	200J	3.000G	100UA 60V	40 4.000A
2N4901	P	S	MOT	605	TO 3	40 40 5.0	5.000A 87.500W	200J	4.000G	100UA 40V	40 1.000A
2N4902	P	S	MOT	605	TO 3	60 60 5.0	5.000A 87.500W	200J	4.000G	100UA 60V	40 1.000A
2N4903	P	S	MOT	605	TO 3	80 80 5.0	5.000A 87.500W	200J	4.000G	100UA 80V	40 1.000A
2N4904	P	S	MOT	605	TO 3	60 60 5.0	5.000A 87.500W	200J	4.000G	100UA 60V	50 2.500A
2N4905	P	S	MOT	605	TO 3	60 60 5.0	5.000A 87.500W	200J	4.000G	100UA 60V	50 2.500A
2N4906	P	S	MOT	605	TO 3	80 80 5.0	5.000A 87.500W	200J	4.000G	100UA 80V	50 2.500A
2N4907	P	S	MOT	605	TO 3	40 40 5.0	10.000A 150.000W	200J	4.000G	2MA 40V	40 4.000A
2N4908	P	S	MOT	605	TO 3	60 60 5.0	10.000A 150.000W	200J	4.000G	2MA 60V	40 4.000A
2N4909	P	S	MOT	605	TO 3	80 80 5.0	10.000A 150.000W	200J	4.000G	2MA 80V	40 4.000A
2N4910	N	S	MOT,FSC	605	TO 66	40 40 5.0	1.000A 25.000W	200J	3.000G	100UA 40V	46 .500A
2N4911	N	S	MOT,FSC	605	TO 66	60 60 5.0	1.000A 25.000W	200J	3.000G	100UA 60V	46 .500A
2N4912	N	S	MOT,FSC	605	TO 66	80 80 5.0	1.000A 25.000W	200J	3.000G	100UA 80V	46 .500A
2N4913	N	S	MOT,TII,FSC,HUG	605	TO 3	60 60 5.0	5.000A 87.500W	200J	4.000G	1MA 60V	50 2.500A
2N4914	N	S	MOT,TII,FSC,HUG	605	TO 3	60 60 5.0	5.000A 87.500W	200J	4.000G	1MA 60V	50 2.500A
2N4915	N	S	MOT,TII,FSC	605	TO 3	80 80 5.0	5.000A 87.500W	200J	4.000G	1MA 80V	50 2.500A
2N4916	N	S	FSC	173	TO106	30 30 5.0	.100A .200W	125J	400.000G	25NA 15V	150 .010A
2N4917	P	S	FSC	173	TO106	30 30 5.0	.100A .200W	125J	450.000G	25NA 15V	200 .010A
2N4918	P	S	MOT	48	48A	40 40 5.0	3.000A 30.000W	150J	3.000G	100UA 40V	46 .500A
2N4919	P	S	MOT	48	48A	60 60 5.0	3.000A 30.000W	150J	3.000G	100UA 60V	46 .500A
2N4920	P	S	MOT	48	48A	80 80 5.0	3.000A 30.000W	150J	3.000G	100UA 80V	46 .500A
2N4921	N	S	MOT	48	48A	40 40 5.0	3.000A 30.000W	150J	3.000G	100UA 40V	46 .500A
2N4922	N	S	MOT	48	48A	60 60 5.0	3.000A 30.000W	150J	3.000G	100UA 60V	46 .500A
2N4923	N	S	MOT	48	48A	80 80 5.0	3.000A 30.000W	150J	3.000G	100UA 80V	46 .500A
2N4924	N	S	MOT	211	TO 39	100 100 5.0	.200A 1.000W	200C	100.000G	100NA 50V	90 .150A
2N4925	N	S	MOT	211	TO 39	150 150 5.0	.200A 1.000W	200C	100.000G	100NA 75V	90 .150A
2N4926	N	S	MOT	211	TO 39	200 200 7.0	.050A 5.000W	200C	30.000G	100NA 100V	70 .030A
2N4927	N	S	MOT	211	TO 39	250 250 7.0	.050A 5.000W	200C	30.000G	100NA 150V	70 .030A
2N4928	P	S	MOT	211	TO 5	100 100 4.0	.100A .600W	200C	100.000G	500NA 50V	75 .010A
2N4929	P	S	MOT	211	TO 5	150 150 4.0	.500A 1.000W	200C	100.000G	500NA 75V	75 .010A
2N4930	P	S	MOT	211	TO 5	200 200 4.0	.500A 1.000W	200C	20.000G	1UA 150V	70 .010A
2N4931	P	S	MOT	211	TO 5	250 250 4.0	.500A 1.000W	200C	20.000G	1UA 150V	70 .010A
2N4932			SEE RF POWER SECTION								
2N4933			SEE RF POWER SECTION								
2N4934	N	S	RCA	218	TO104	40 40 3.0	.200W	200J	700.000G	10NA 15V	80 .002A
2N4935	N	S	RCA	218	TO104	40 40 3.0	.200W	200J	700.000G	10NA 15V	10 .002A
2N4936	N	S	RCA	218	TO104	30 30 3.0	.200W	200J	700.000G	10NA 15V	120 .002A
2N4943	N	S	NSC	211	TO 5	120 80 7.0	1.000A .800W	200J	150.000G	10NA 60V	175 .150A
2N4944	N	S	FSC	173	TO106	80 40 5.0	.200W 125J		60.000G	50NA 40V	80 .150A
2N4945	N	S	FSC	173	TO106	80 40 5.0	.220W 125J		60.000G	50NA 40V	80 .150A
2N4946	N	S	FSC	173	TO106	80 40 5.0	.220W 125J		60.000G	50NA 40V	150 .150A
2N4950	N	S	SPC	563	TO114	80 60 10.0	70.000A 300.000W	200J		2MA 50V	45 4.000A
2N4951	N	S	GEC,SPR,HUG	45	TO 98	60 30 5.0	.500A .360W	150J	250.000G	50NA 40V	110 .150A
2N4952	N	S	GEC,SPR,HUG	45	TO 98	60 30 5.0	.500A .360W	150J	250.000G	50NA 40V	176 .150A
2N4953	N	S	GEC,SPR,HUG	45	TO 98	60 30 5.0	.500A .360W	150J	250.000G	50NA 40V	350 .150A
2N4954	N	S	GEC,SPR,HUG	45	TO 98	60 40 5.0	.500A .360W	150J	250.000G	50NA 30V	210 .150A
2N4957	P	S	MOT	217	TO 72	30 30 3.0	.030A .200W	200J	120.000G	100NA 20V	40 .002A
2N4958	P	S	MOT	217	TO 72	30 30 3.0	.030A .200W	200J	100.000G	100NA 20V	40 .002A
2N4959	P	S	MOT	217	TO 72	30 30 3.0	.030A .200W	200J	100.000G	100NA 20V	40 .002A
2N4960	N	S	FSC	211	TO 39	60 6.5	.800W	200J	250.000G	10NA 50V	100 .150A
2N4961	N	S	FSC	211	TO 39	80 6.5	.800W	200J	250.000G	10NA 50V	100 .150A
2N4962	N	S	FSC	211	TO 18	60 60 6.5	.500W 200J		250.000G	10NA 50V	100 .150A
2N4963	N	S	FSC	211	TO 18	80 80 6.5	.500W 200J		250.000G	10NA 50V	100 .150A
2N4964	P	S	FSC	173	TO106	50 40 5.0	.100A .200W	125J	60.000G	25NA 20V	60 .001A
2N4965	P	S	FSC	173	TO106	50 40 5.0	.100A .200W	125J	60.000G	25NA 20V	180 .001A
2N4966	N	S	NSC	173	TO106	50 40 6.0	.030A .200W	125J	40.000G	25NA 25V	90 .002A
2N4967	N	S	NSC	173	TO106	50 40 6.0	.030A .200W	125J	40.000G	25NA 25V	250 .001A
2N4968	N	S	NSC	173	TO106	30 25 6.0	.030A .200W	125J	40.000G	50NA 25V	90 .001A
2N4969	N	S	NSC	173	TO106	50 30 5.0	.500A .200W	125J	200.000G	50NA 30V	70 .150A
2N4970	N	S	NSC	173	TO106	50 30 5.0	.500A .200W	125J	200.000G	50NA 30V	188 .150A
2N4971	P	S	NSC	173	TO106	50 40 5.0	.500A .200W	125J	200.000G	25NA 30V	40 .002A
2N4972	P	S	NSC	173	TO106	50 40 5.0	.500A .200W	125J	200.000G	25NA 30V	175 .150A
2N4980	P	S	NSC	211	TO						

Transistor Type No.	N P	G S	Manufacturer	Lead Ident	Out- line	Maximum (V)			Maximum		Max. T.(°C)	Frequency Resp.(MHz)	Leakage		Gain h _{FE} @ I _C	
						V _{CE}	V _{ES}	V _{ES}	I _C	Power			I _{CE0}	V _{CE0}		
2N4998	N	S	FSC	560	TO 59	100S	6.0	2.000A	30.000W	200J	50.000G	1UA	60V	63	1.000A	
2N4999	P	S	FSC	560	TO 59	80	5.5	5.000A	50.000W	200J	60.000G	1UA	60V	50	2.500A	
2N5000	N	S	FSC	560	TO 59	100S	6.0	2.000A	30.000W	200J	60.000G	1UA	60V	111	1.000A	
2N5001	P	S	FSC	560	TO 59	80	5.5	5.000A	50.000W	200J	70.000G	1UA	60V	114	2.500A	
2N5002	N	S	FSC,BEN	560	TO 59	100S	6.0	5.000A	50.000W	200J	60.000G	1UA	60V	64	2.500A	
2N5003	P	S	FSC	560	TO 59	80	5.5	2.000A	30.000W	200J	50.000G	1UA	60V	40	1.000A	
2N5004	N	S	FSC,BEN	560	TO 59	100S	6.0	5.000A	50.000W	200J	70.000G	1UA	60V	114	2.500A	
2N5005	P	S	FSC	560	TO 59	80	5.5	2.000A	30.000W	200J	60.000G	1UA	60V	88	1.000A	
2N5006	N	S	FSC	560	TO 61	100S	6.0	10.000A	100.000W	200J	30.000G	1MA	60V	42	5.000A	
2N5007	P	S	FSC	560	TO 61	100	80	5.5	10.000A	100.000W	200J	30.000G	1UA	60V	52	5.000A
2N5008	N	S	FSC	560	TO 61	100S	6.0	10.000A	100.000W	200J	40.000G	1UA	60V	108	5.000A	
2N5009	P	S	FSC	560	TO 61	100	80	5.5	10.000A	100.000W	200J	30.000G	1UA	60V	120	5.000A
2N5016			SEE RF POWER SECTION													
2N5017	-N	S	RCA	970	970A	65X	4.0	4.500A	30.000W	200J	600.000G	10MA	30V	4		
2N5022	P	S	FSC,RAY	211	TO 39	50	5.0	1.000A	1.000W	200J	170.000G	100NA	30V	45	500A	
2N5023	P	S	FSC,RAY	211	TO 39	30	3.0	5.000A	1.000W	200J	200.000G	100NA	20V	60	500A	
2N5025			SEE RF POWER SECTION													
2N5026			SEE RF POWER SECTION													
2N5027	N	S	GECC,SPR	45	TO 98	60	3.0	5.0	.350A	.320W	120J	250.000G	100NA	40V	88	.150A
2N5028	N	S	GECC,SPR	45	TO 98	60	3.0	5.0	.350A	.320W	120J	250.000G	100NA	40V	176	.150A
2N5029	N	S	GECC	45	TO 98	40	15	4.5	.200A	.320W	120J	500.000G	250NA	20V	70	.010A
2N5030	N	S	GECC	45	TO 98	30	12	4.0	.200A	.320W	120J	40.000G	250NA	20V	105	.010A
2N5031	N	S	MOT	217	TO 72	15	10	3.0	.020A	.200W	200A	1000.000G	10NA	6V	100	.001A
2N5032	N	S	MOT	217	TO 72	15	10	3.0	.020A	.200W	200A	1000.000G	10NA	6V	100	.001A
2N5033	N	S	RCA	980	980A	55	40	5.0	6.000A	83.000W	150J	.800G	1MA	35V	40	4.000A
2N5035	N	S	RCA	981	981A	55	40	5.0	6.000A	83.000W	150J	.800G	1MA	35V	40	4.000A
2N5036	N	S	RCA	980	980A	70	50	5.0	8.000A	83.000W	150J	.800G	1MA	35V	40	5.000A
2N5037	N	S	RCA	981	981A	70	50	5.0	8.000A	83.000W	150J	.800G	1MA	50V	40	5.000A
2N5038	N	S	RCA	605	TO 3	150	90	7.0	20.000A	140.000W	200J	60.000G	20MA	70V	100	2.000A
2N5039	N	S	RCA	605	TO 3	120	75	7.0	20.000A	140.000W	200J	60.000G	20MA	55V	68	2.000A
2N5040	P	S	FSC,SOL	173	TO105	25	25	4.0	.300W	.125J	80.000G	50NA	15V	75	.500A	
2N5041	P	S	FSC	173	TO105	40	40	5.0	.300W	.125J	100.000G	50NA	30V	65	.500A	
2N5042	P	S	FSC	211	TO 39	40	4.0	5.0	.800W	.200J	100.000G	50NA	15V	72	.150A	
2N5043	P	G	THI	217	TO 72	15	7	3	.030A	.030W	125J	1500.000G	6UA	10V	53	.003A
2N5044	P	G	THI	217	TO 72	15	7	3	.030A	.030W	125J	1500.000G	6UA	10V	53	.003A
2N5048	-N	S	GECC	561	TO 61	60	50	14.0	10.000A	100.000W	175J	10.000G	10MA	60V	30	10.000A
2N5049	-N	S	GECC	561	TO 61	120	100	14.0	10.000A	100.000W	175J	10.000G	1MA	120V	30	10.000A
2N5050	N	S	MOT	565	TO 66	125	6.0	2.000A	40.000W	175J	500.000G	10NA	15V	72	.025A	
2N5051	N	S	MOT	605	TO 66	150	15.0	6.0	2.000A	40.000W	175J	500.000G	50UA	150V	50	.750A
2N5052	N	S	MOT	605	TO 66	200	20.0	6.0	2.000A	40.000W	175J	10.000G	50UA	200V	50	.750A
2N5053	N	S	AMP	217	TO 72	30	15	3.0	.025A	.200W	200J	1300.000G	10NA	15V	52	.025A
2N5054	N	S	AMP	217	TO 72	30	15	3.0	.025A	.200W	200J	1500.000G	10NA	15V	52	.025A
2N5055	N	S	FSC	211	TO 102	12	4	4.5	1.00A	.360W	200J	450.000G	50NA	10V	55	.100A
2N5056	P	S	FSC	211	TO 18	15	15	4.5	1.00A	.360W	200J	600.000G	50NA	10V	55	.030A
2N5057	P	S	FSC	211	TO 18	15	15	4.5	1.00A	.360W	200J	800.000G	50NA	10V	65	.030A
2N5058	N	S	THI	211	TO 5	300	300	7.0	1.50A	1.000W	175J	30.000G	50NA	100V	73	.030A
2N5059	N	S	THI	211	TO 5	250	250	6.0	1.50A	1.000W	175J	30.000G	50NA	100V	68	.030A
2N5067	N	S	MOT,FSC,HUG	605	TO 3	40	40	5.0	5.000A	87.500W	200J	4.000G	1MA	40V	40	1.000A
2N5068	N	S	MOT,FSC,HUG	605	TO 3	60	60	5.0	5.000A	87.500W	200J	4.000G	1MA	60V	40	1.000A
2N5069	N	S	MOT,FSC,HUG	605	TO 3	80	80	5.0	5.000A	87.500W	200J	4.000G	1MA	80V	40	1.000A
2N5070			SEE RF POWER SECTION													
2N5071			SEE RF POWER SECTION													
2N5074	N	S	FSC	560	TO 59	200S	6.0	3.000A	60.000W	200J	40.000G	10UA	150V	21	3.000A	
2N5075	N	S	FSC	560	TO 59	200S	6.0	3.000A	60.000W	200J	40.000G	10UA	150V	32	3.000A	
2N5076	N	S	FSC	560	TO 59	250S	6.0	3.000A	60.000W	200J	40.000G	10UA	150V	21	3.000A	
2N5077	N	S	FSC	560	TO 59	250S	6.0	3.000A	60.000W	200J	40.000G	10UA	150V	32	3.000A	
2N5083	N	S	FSC	560	TO 59	120	60	6.0	10.000A	35.000W	200J	50.000G	1MA	120V	70	2.000A
2N5084	N	S	FSC	560	TO 59	120	60	6.0	10.000A	35.000W	200J	80.000G	1MA	120V	175	2.000A
2N5085	N	S	FSC	560	TO 59	150	80	6.0	10.000A	35.000W	200J	50.000G	1MA	150V	70	2.000A
2N5086	N	S	MOT	41	TO 92	50	50	3.0	.050A	.310W	135J	40.000G	50NA	35V	276	.001A
2N5087	N	S	MOT	41	TO 92	35	35	4.5	.050A	.310W	135J	40.000G	50NA	10V	120	.001A
2N5088	N	S	MOT	41	TO 92	35	35	4.5	.050A	.310W	135J	50.000G	50NA	20V	524	.001A
2N5089	N	S	MOT	41	TO 92	30	25	4.5	.050A	.310W	135J	50.000G	50NA	15V	700	.001A
2N5090			SEE RF POWER SECTION													
2N5102			SEE RF POWER SECTION													
2N5106	N	S	FSC	210	TO 39	60	30	5.0	500A	.800W	200J	250.000G	10NA	50V	175	.150A
2N5107	N	S	FSC	210	TO 39	60	30	5.0	500A	.360W	200J	250.000G	10NA	50V	175	.150A
2N5108			SEE RF POWER SECTION													
2N5108A			SEE RF POWER SECTION													
2N5109			SEE RF POWER SECTION													
2N5110	P	S	STC	211	TO 5	40	40	10.0	1.000A	5.000W	175J	1.000G	100UA	20V	12	1.000A
2N5111	P	S	STC	211	TO 5	80	80	10.0	1.000A	5.000W	175J	1.000G	100UA	40V	12	1.000A
2N5112	P	S	STC	561	TO 59	40	40	10.0	1.000A	34.000W	175J	1.000G	100UA	20V	12	1.000A
2N5113	P	S	STC	561	TO 59	80	80	10.0	1.000A	34.000W	175J	1.000G	100UA	40V	12	1.000A
2N5126	N	S	FSC,NSC	173	TO106	20	20	3.0	.200W	125J	300.000G	50NA	10V	70	.004A	
2N5127	N	S	FSC,NSC	173	TO106	20	12	3.0	.200W	125J	150.000G	50NA	10V	70	.015A	
2N5128	N	S	FSC,NSC	173	TO105	15	12	3.0	.200W	125J	200.000G	50NA	10V	75	.005A	
2N5129	N	S	FSC,NSC	173	TO106	15	12	3.0	.200W	125J	200.000G	50NA	10V	75	.050A	
2N5130	N	S	FSC,NSC	173	TO106	30	12	1.0	.200W	125J	450.000G	50NA	10V	50	.008A	
2N5131	N	S	FSC,NSC	173	TO106	20	15	3.0	3.000A	2.000W	125J	100.000G	50NA	10V	150	.010A
2N5132	N	S	FSC,NSC	173	TO106	20	20	3.0	.200W	125J	200.000G	50NA	10V	130	.010A	
2N5133	N	S	FSC,NSC	173	TO106	20	18	3.0	.200W	125J	40.000G	50NA	15V	220	.001A	
2N5134	N	S	FSC	173	TO106	20	10	3.5	1.00A	.200W	125J	400.000G	400NA	15V	66	.010A
2N5135	N	S	FSC,NSC	173	TO105	30	25	4.0	.300W	125J	40.000G	300NA	15V	400	.010A	
2N5136	N	S	FSC,NSC	173	TO105	30	20	3.0	1.00A	.310W	125J	40.000G	100NA	15V	150	.010A
2N5137	N	S	FSC,NSC	173	TO106	30	20	3.0	.220W	125J	40.000G	100NA	20V	100	.150A	
2N5138	P	S	FSC,NSC	173	TO106	30	30	5.0	.200W	125J	30.000G	10NA	20V	120	.010A	
2N5139	P	S	FSC,NSC	173	TO106	20	20	5.0	1.00A	.200W	125J	300.000G	50NA	15V		

Transistor Type No.	N P S	E S	Manufacturer	Lead Ident	Out- line	Maximum (V)			Maximum		Max.	Frequency	Leakage		Gain	
						V _{CE}	V _{CE}	V _{CE}	I _C	Power	T _J (°C)	Resp.(MHz)	I _{CE} @ V _{CE}	I _{CE} @ V _{CE}	h _{FE} @ I _C	h _{FE} @ I _C
2N5176	N	S	GE	45	TO 98	130	100	5.0	.025A	-.200W	100J	1000.000G	500NA	60V	214	.010A
2N5179	N	S	RCA	218	TO 72	20	12	2.5	.050A	-.200W	100J	650.000G	25NA	15V	70	.003A
2N5180	N	S	RCA	218	TO104	30	15	2.0	.180W	-.180W	175J	700.000G	25NA	1V	70	.002A
2N5181	N	S	RCA	218	TO104	45	45	3.0	.050A	-.180W	175J	700.000G	1UA	45V	96	.001A
2N5182	N	S	RCA	218	TO104	45	45	3.0	.004A	-.180W	175J	700.000G	1UA	45V	96	.001A
2N5183	N	S	RCA	211	TO104	18	18	7.0	1.000A	-.500W	175J	125.000G	500NA	12V	150	.010A
2N5184	N	S	RCA	211	TO104	18	18	7.0	.050A	-.500W	175J	30.000G	100NA	120V	56	.050A
2N5185	N	S	RCA	211	211M	120	5.0	5.0	.050A	1.000W	175J	30.000G	100NA	120V	56	.050A
2N5186	N	S	RCA	211	211M	10	10	3.0	.300A	.300W	200J	400.000G	50NA	5V	50	.010A
2N5187	N	S	RCA	211	TO 52	25	10	5.0	.500A	.800W	200J	400.000G	400NA	20V	50	.030A
2N5188	N	S	RCA	211	TO 39	20	25	5.0	.300A	.300W	200J	320.000G	500NA	30V	40	.500A
2N5189	N	S	RCA	211	2110	60	35	5.0	.050A	.800W	200J	250.000G	500NA	30V	6	100A
2N5190	N	S	MOT	48	48A	40	40	4.0	4.000A	40.000W	150J	2.000G	100UA	40V	50	1.500A
2N5191	N	S	MOT	48	48A	60	60	4.0	4.000A	40.000W	150J	2.000G	100UA	60V	50	1.500A
2N5192	N	S	MOT	48	48A	80	80	4.0	4.000A	40.000W	150J	2.000G	100UA	40V	50	1.500A
2N5193	N	S	MOT	48	48A	40	40	4.0	4.000A	40.000W	150J	2.000G	100UA	60V	50	1.500A
2N5194	P	S	MOT	48	48A	60	60	4.0	4.000A	40.000W	150J	2.000G	100UA	60V	50	1.500A
2N5195	P	S	MOT	48	48A	80	80	4.0	4.000A	40.000W	150J	2.000G	100UA	80V	40	1.500A
2N5202	N	S	RCA	605	TO 66	120	75R	7.0	4.000A	35.000W	200J	60.000G	10NA	10V	50	.002A
2N5208	N	S	MOT	41	TO 92	30	25	4.0	.050A	.310W	135J	30.000G	50NA	35V	350	.001A
2N5209	N	S	MOT	41	TO 92	50	50	4.5	.050A	.310W	135J	30.000G	50NA	35V	350	.001A
2N5210	N	S	MOT	41	TO 92	50	50	4.5	.050A	.310W	135J	30.000G	50NA	35V	350	.001A
2N5218	N	S	SOL HUG	561	TO 61	220	200	8.0	10.000A	50.000W	200J	40.000G	500NA	10V	160	.002A
2N5219	N	S	MOT	41	TO 92	15	15	3.0	1.00A	.310W	135J	150.000G	100NA	10V	180	.050A
2N5220	N	S	MOT	41	TO 92	15	15	3.0	.500A	.310W	135J	100.000G	100NA	10V	180	.050A
2N5221	N	S	MOT	41	TO 92	15	15	3.0	.500A	.310W	135J	100.000G	100NA	10V	180	.050A
2N5222	N	S	MOT	41	TO 92	25	25	4.0	.500A	.310W	135J	100.000G	100NA	15V	180	.050A
2N5224	N	S	MOT	41	TO 92	25	25	4.0	.500A	.310W	135J	100.000G	100NA	15V	180	.050A
2N5225	N	S	MOT	41	TO 92	25	25	4.0	.500A	.310W	135J	100.000G	100NA	15V	180	.050A
2N5226	N	S	MOT	41	TO 92	25	25	4.0	.500A	.310W	135J	100.000G	100NA	15V	180	.050A
2N5227	N	S	MOT	41	TO 92	30	30	3.0	.050A	.310W	135J	100.000G	100NA	15V	45	.010A
2N5228	P	S	MOT	41	TO 92	5	5	3.0	.050A	.310W	135J	100.000G	1NA	12V	75	.001A
2N5229	P	S	MOT	215	TO 46	15	15	0.5	.050A	.500W	200J	8.000G	1NA	25V	75	.001A
2N5230	P	S	MOT	210	TO 46	30	30	0.5	.050A	.500W	200J	8.000G	1NA	25V	75	.001A
2N5231	P	S	MOT	210	TO 46	50	30	50.0	.050A	.500W	200J	8.000G	1NA	40V	75	.001A
2N5232	N	S	GE	45	TO 98	70	50	5.0	1.00A	.330W	125J	AUD	30NA	50V	375	.002A
2N5232A	N	S	GE	45	TO 98	70	50	5.0	1.00A	.330W	125J	AUD	30NA	50V	375	.002A
2N5239	N	S	RCA	605	TO 3	330	225	6.0	5.000A	100.000W	200J	5.000G	4MA	300V	40	.400A
2N5240	N	S	RCA	605	TO 3	375	300	6.0	5.000A	100.000W	200J	5.000G	2MA	375V	40	.400A
2N5241	N	S	DEL BEN	605	TO 3	400	50	5.0	5.000A			4.000G	3MA	400V	24	2.500A
2N5244	N	S	FSC	211	TO 18	40	40	5.0	1.00A	.360W	200J	450.000G	151NA	50V	600	.002A
2N5249	N	S	GE	45	TO 98	70	50	5.0	1.00A	.330W	125J	1.200G	30NA	50V	600	.002A
2N5249A	N	S	GE	45	TO 98	70	50	5.0	1.00A	.330W	125J	1.200G	30NA	50V	600	.002A
2N5250	N	S	TEC. SOL HUG	563	TO 114	125	100	8.0	200.000G			15.000G	100UA	125V	30	40.000A
2N5251	N	S	TEC. SOL	563	TO 114	180	150	8.0	200.000G			15.000G	100UA	180V	40	40.000A
2N5262	N	S	RCA	211	TO 39	75	50	5.0	2.00A	1.000W	200J	250.000G	10UA	60V	65	.500A
2N5263	N	S	AMP	890	890A	1	1	5.0	.025A	.160W	150A	1000.000G	1UA	400V	105	1.000A
2N5264	N	S	FSC	605	TO 59	400	180	5.0	10.000A	87.000W	200J	50.000G	1MA	80V	64	2.000A
2N5284	N	S	FSC	560	TO 59	120S	6.0	5.0	5.000A	50.000W	200J	60.000G	1UA	80V	114	2.500A
2N5285	N	S	FSC	560	TO 59	120S	6.0	5.0	5.000A	50.000W	200J	60.000G	1UA	80V	50	2.500A
2N5286	N	S	FSC	560	TO 59	100S	5.5	5.0	5.000A	50.000W	200J	60.000G	1UA	80V	114	2.500A
2N5287	N	S	FSC	560	TO 59	100S	5.5	5.0	5.000A	50.000W	200J	60.000G	1UA	80V	114	2.500A
2N5288	N	S	FSC	560	TO 61	120S	6.0	10.000A	100.000W	200J	30.000G	1MA	120V	52	5.000A	
2N5289	N	S	FSC	560	TO 61	120S	6.0	10.000A	100.000W	200J	40.000G	1MA	120V	52	5.000A	
2N5290	N	S	FSC	560	TO 61	75	100S	5.5	10.000A	100.000W	200J	40.000G	1MA	100V	52	5.000A
2N5291	N	S	FSC	560	TO 61	100S	5.5	10.000A	100.000W	200J	40.000G	1MA	100V	120	5.000A	
2N5293	N	S	RCA	53	53A	80	70	7.0	4.000A	36.000W	150J	.800G	500NA	65V	60	500A
2N5294	N	S	RCA	54	54A	80	70	7.0	4.000A	36.000W	150J	.800G	2MA	35V	60	500A
2N5295	N	S	RCA	53	53A	80	40	5.0	4.000A	36.000W	150J	.800G	500NA	65V	60	1.000A
2N5296	N	S	RCA	54	54A	80	40	5.0	4.000A	36.000W	150J	.800G	500NA	65V	60	1.000A
2N5297	N	S	RCA	53	53A	80	60	5.0	4.000A	36.000W	150J	.800G	2MA	35V	40	1.500A
2N5298	N	S	RCA	54	54A	80	60	5.0	4.000A	36.000W	150J	.800G	500NA	65V	40	1.500A
2N5301	N	S	MOT	605	TO 3	40	40	5.0	30.000A	200.000W	200J	2.000G	1MA	40V	35	10.000A
2N5302	N	S	MOT	605	TO 3	60	60	5.0	30.000A	200.000W	200J	2.000G	1MA	40V	10	15.000A
2N5303	N	S	MOT	605	TO 3	80	80	5.0	30.000A	200.000W	200J	2.000G	1MA	80V	30	10.000A
2N5309	N	S	GE	45	TO 98	70	50	5.0	1.00A	.360W	125J	1.000G	10NA	50V	90	.001A
2N5310	N	S	GE	45	TO 98	70	50	5.0	1.00A	.360W	125J	1.000G	10NA	50V	175	.001A
2N5312	P	S	SOL HUG	560	TO 61	80	80	6.0	10.000A	50.000W	200J	30.000G	10UA	80V	52	10.000A
2N5313	P	S	SOL HUG	560	TO 61	80	80	6.0	20.000A	50.000W	200J	30.000G	10UA	80V	52	10.000A
2N5314	P	S	SOL HUG	560	TO 61	100	100	6.0	10.000A	50.000W	200J	30.000G	10UA	100V	52	10.000A
2N5315	P	S	SOL HUG	560	TO 61	100	100	6.0	20.000A	50.000W	200J	30.000G	10UA	100V	52	10.000A
2N5316	P	S	SOL HUG	560	TO 61	80	80	6.0	10.000A	50.000W	200J	30.000G	10UA	80V	52	5.000A
2N5317	P	S	SOL HUG	560	TO 61	80	80	6.0	10.000A	50.000W	200J	30.000G	10UA	100V	52	5.000A
2N5318	P	S	SOL HUG	560	TO 61	100	100	6.0	10.000A	50.000W	200J	30.000G	10UA	100V	52	5.000A
2N5319	P	S	SOL HUG	560	TO 61	100	100	6.0	10.000A	50.000W	200J	30.000G	10UA	100V	52	5.000A
2N5320	N	S	RCA	211	TO 5	100	75	7.0	2.000A	10.000W	200J	50.000G	500NA	80V	72	500A
2N5321	N	S	RCA	211	TO 5	100	75	7.0	2.000A	10.000W	200J	50.000G	500NA	80V	72	500A
2N5322	N	S	RCA	211	TO 3	75	50	5.0	2.000A	10.000W	200J	50.000G	500NA	80V	72	500A
2N5323	P	S	RCA	211	TO 3	75	50	5.0	2.000A	10.000W	200J	50.000G	500NA	80V	72	500A
2N5324	P	G	MOT	605	TO 3	250	150	4.0	10.000A	56.000W	110J	2.000G	7MA	250V	35	5.000A
2N5325	P	G	MOT	605	TO 3	325	200	4.0	10.000A	56.000W	110J	2.000G	7MA	325V	35	5.000A
2N5326	N	S	TRW	560	TO 59	100	80	6.0	5.000A	20.000W	200J	100.000G	100UA	90V	88	5.000A
2N5327	N															

Transistor Type No.	N P	G S	Manufacturer	Lead Ident	Out- line	Maximum (V)			Maximum		Max. T.(°C)	Frequency Resp.(MHz)	Leakage		Gain	
						V _{CE}	V _{ES}	V _{ES}	I _C	Power			I _{ES} @ V _{CE}	h _{FE} @ I _C		
2N5369	N	S	SPR	168	168A	60	30	5.0	.500A	.360W	150J	250.000G	50NA	40V	175	.150A
2N5370	N	S	SPR	168	168A	60	30	5.0	.500A	.360W	150J	250.000G	50NA	40V	350	.150A
2N5371	N	S	SPR	168	168A	60	30	5.0	.500A	.360W	150J	250.000G	50NA	40V	210	.150A
2N5372	N	S	SPR	168	168A	60	30	5.0	.500A	.360W	150J	250.000G	50NA	40V	70	.150A
2N5373	P	S	SPR	168	168A	60	30	5.0	.500A	.360W	150J	150.000G	50NA	40V	175	.150A
2N5374	P	S	SPR	168	168A	60	30	5.0	.500A	.360W	150J	150.000G	50NA	40V	300	.150A
2N5375	P	S	SPR	168	168A	60	30	5.0	.500A	.360W	150J	150.000G	50NA	40V	300	.150A
2N5376	N	S	SPR	168	168A	60	30	5.0	.500A	.360W	150J	150.000G	50NA	30V	140	.150A
2N5377	N	S	SPR	168	168A	60	30	5.0	.500A	.360W	150J	300.000G	10NA	30V	270	.001A
2N5378	P	S	SPR	168	168A	60	30	5.0	.500A	.360W	150J	300.000G	10NA	30V	225	.001A
2N5379	P	S	SPR	168	168B	40	40	5.0	.500A	.360W	150J	200.000G	10NA	30V	270	.001A
2N5380	N	S	SPR	168	168A	40	30	5.0	.500A	.360W	150J	200.000G	10NA	30V	225	.001A
2N5381	N	S	SPR	168	168B	40	40	5.0	.500A	.360W	150J	250.000G	88	10A	80	.010A
2N5382	N	S	SPR	168	168B	40	40	5.0	.500A	.360W	150J	300.000G	175	10A	100	.010A
2N5383	P	S	SPR	168	168B	40	40	5.0	.500A	.360W	150J	250.000G	198	10A	100	.010A
2N5384	P	S	SPR	168	168B	40	40	5.0	.500A	.360W	150J	250.000G	198	10A	100	.010A
2N5385	P	S	SPR	168	168B	40	40	5.0	.500A	.360W	150J	250.000G	198	10A	100	.010A
2N5386	P	S	SPR	168	168B	40	40	5.0	.500A	.360W	150J	250.000G	198	10A	100	.010A
2N5387	P	S	SPR	168	168B	40	40	5.0	.500A	.360W	150J	250.000G	198	10A	100	.010A
2N5388	P	S	SPR	168	168B	40	40	5.0	.500A	.360W	150J	250.000G	198	10A	100	.010A
2N5389	N	S	SPR	168	168B	40	40	5.0	.500A	.360W	150J	250.000G	198	10A	100	.010A
2N5400	N	S	MOT	541	TO 61	250	250	7.5	7.500A	100.000W	200J	15.000G	1MA	250V	50	2.000A
2N5401	N	S	MOT	541	TO 61	300	300	7.5	7.500A	100.000W	200J	15.000G	1MA	300V	50	2.000A
2N5402	P	S	SOL HUG	211	TO 92	130	120	5.0	.600A	.310W	135A	100.000G	100NA	100V	85	.010A
2N5403	P	S	SOL HUG	211	TO 92	160	150	5.0	.600A	.310W	135A	100.000G	50NA	120V	120	.010A
2N5404	P	S	SOL HUG	211	TO 5	100	100	6.0	5.000A	5.000W	200J	40.000G	10UA	80V	35	2.000A
2N5405	P	S	SOL HUG	211	TO 5	100	100	6.0	5.000A	5.000W	200J	40.000G	10UA	100V	35	2.000A
2N5406	P	S	SOL HUG	211	TO 5	100	100	6.0	5.000A	5.000W	200J	40.000G	10UA	80V	70	2.000A
2N5407	P	S	SOL HUG	211	TO 5	100	100	6.0	5.000A	5.000W	200J	40.000G	10UA	100V	35	2.000A
2N5408	P	S	SOL HUG	568	TO111	80	80	6.0	5.000A	30.000W	200J	40.000G	10UA	100V	70	2.000A
2N5409	P	S	SOL HUG	568	TO111	100	100	6.0	5.000A	30.000W	200J	40.000G	10UA	100V	35	2.000A
2N5410	P	S	SOL HUG	568	TO111	80	80	6.0	5.000A	30.000W	200J	40.000G	10UA	100V	70	2.000A
2N5411	P	S	SOL HUG	568	TO111	100	100	6.0	5.000A	30.000W	200J	40.000G	10UA	100V	70	2.000A
2N5412	N	S	BEN	561	TO 61	80	60	7.0	15.000A	100.000W	200J	60.000G	1MA	80V	80	2.000A
2N5413	N	S	RCA	211	TO 5	200	4.0	1.000A	1.000W	200J	15.000G	50UA	50V	60	0.050A	
2N5414	N	S	RCA	211	TO 5	350	300	6.0	1.000A	1.000W	200J	15.000G	50UA	250V	60	0.050A
2N5415	N	S	RCA	211	TO 5	40	35	3.0	.500A	.500W	200J	250.000G	10NA	30V	140	.150A
2N5416	N	S	RCA	211	TO 39	40	35	3.0	.500A	.500W	200J	250.000G	10NA	30V	140	.150A
2N5417	N	S	RCA	211	TO 39	40	35	3.0	.500A	.500W	200J	250.000G	10NA	30V	140	.150A
2N5421			SEE RF POWER SECTION													
2N5422			SEE RF POWER SECTION													
2N5423			SEE RF POWER SECTION													
2N5424			SEE RF POWER SECTION													
2N5427	N	S	MOT	605	TO 66	80	80	6.0	7.000A	40.000W	200J	30.000G	10UA	80V	60	2.000A
2N5428	N	S	MOT	605	TO 66	80	80	6.0	7.000A	40.000W	200J	30.000G	10UA	80V	120	2.000A
2N5429	N	S	MOT	605	TO 66	100	100	6.0	7.000A	40.000W	200J	30.000G	10UA	100V	120	2.000A
2N5430	N	S	MOT	605	TO 66	100	100	6.0	7.000A	40.000W	200J	30.000G	10UA	100V	120	2.000A
2N5431	P	G	MOT	605	TO 3	80	60	2.5	60.000A	120.000W	110J	.350G	10MA	80V	35	25.000A
2N5432	P	G	MOT	605	TO 3	110	90	2.5	60.000A	120.000W	110J	.350G	10MA	110V	35	25.000A
2N5433	P	G	MOT	605	TO 3	140	120	2.5	60.000A	120.000W	110J	.350G	10MA	140V	35	25.000A
2N5434	P	G	MOT	605	TO 3	80	60	2.5	60.000A	120.000W	110J	.350G	10MA	80V	35	25.000A
2N5435	P	G	MOT	605	TO 3	110	90	2.5	60.000A	120.000W	110J	.350G	10MA	110V	35	25.000A
2N5436	P	G	MOT	605	TO 3	140	120	2.5	60.000A	120.000W	110J	.350G	10MA	140V	35	25.000A
2N5437	P	G	MOT	605	TO 3	110	90	2.5	60.000A	120.000W	110J	.350G	10MA	110V	35	25.000A
2N5438	P	G	MOT	605	TO 3	140	120	2.5	60.000A	120.000W	110J	.350G	10MA	140V	35	25.000A
2N5440	P	G	MOT	605	TO 3	110	90	2.5	60.000A	120.000W	110J	.350G	10MA	110V	35	25.000A
2N5441	P	G	MOT	605	TO 3	140	120	2.5	60.000A	120.000W	110J	.350G	10MA	140V	35	25.000A
2N5442	P	G	MOT	605	TO 3	110	90	2.5	60.000A	120.000W	110J	.350G	10MA	110V	35	25.000A
2N5443	P	G	MOT	605	TO 3	140	120	2.5	60.000A	120.000W	110J	.350G	10MA	140V	35	25.000A
2N5444	P	G	MOT	605	TO 3	110	90	2.5	60.000A	120.000W	110J	.350G	10MA	110V	35	25.000A
2N5445	P	G	MOT	605	TO 3	140	120	2.5	60.000A	120.000W	110J	.350G	10MA	140V	35	25.000A
2N5446	P	G	MOT	605	TO 3	110	90	2.5	60.000A	120.000W	110J	.350G	10MA	110V	35	25.000A
2N5447	P	G	MOT	605	TO 3	140	120	2.5	60.000A	120.000W	110J	.350G	10MA	140V	35	25.000A
2N5448	P	G	MOT	605	TO 3	110	90	2.5	60.000A	120.000W	110J	.350G	10MA	110V	35	25.000A
2N5449	P	G	MOT	605	TO 3	140	120	2.5	60.000A	120.000W	110J	.350G	10MA	140V	35	25.000A
2N5450	P	G	MOT	605	TO 3	110	90	2.5	60.000A	120.000W	110J	.350G	10MA	110V	35	25.000A
2N5451	P	G	MOT	605	TO 3	140	120	2.5	60.000A	120.000W	110J	.350G	10MA	140V	35	25.000A
2N5452	P	G	MOT	605	TO 3	110	90	2.5	60.000A	120.000W	110J	.350G	10MA	110V	35	25.000A
2N5453	P	G	MOT	605	TO 3	140	120	2.5	60.000A	120.000W	110J	.350G	10MA	140V	35	25.000A
2N5454	P	G	MOT	605	TO 3	110	90	2.5	60.000A	120.000W	110J	.350G	10MA	110V	35	25.000A
2N5455	P	G	MOT	605	TO 3	140	120	2.5	60.000A	120.000W	110J	.350G	10MA	140V	35	25.000A
2N5456	P	G	MOT	605	TO 3	110	90	2.5	60.000A	120.000W	110J	.350G	10MA	110V	35	25.000A
2N5457	P	G	MOT	605	TO 3	140	120	2.5	60.000A	120.000W	110J	.350G	10MA	140V	35	25.000A
2N5458	P	G	MOT	605	TO 3	110	90	2.5	60.000A	120.000W	110J	.350G	10MA	110V	35	25.000A
2N5459	P	G	MOT	605	TO 3	140	120	2.5	60.000A	120.000W	110J	.350G	10MA	140V	35	25.000A
2N5460	P	G	MOT	605	TO 3	110	90	2.5	60.000A	120.000W	110J	.350G	10MA	110V	35	25.000A
2N5461	P	G	MOT	605	TO 3	140	120	2.5	60.000A	120.000W	110J	.350G	10MA	140V	35	25.000A
2N5462	P	G	MOT	605	TO 3	110	90	2.5	60.000A	120.000W	110J	.350G	10MA	110V	35	25.000A
2N5463	P	G	MOT	605	TO 3	140	120	2.5	60.000A	120.000W	110J	.350G	10MA	140V	35	25.000A
2N5464	P	G	MOT	605	TO 3	110	90	2.5	60.000A	120.000W	110J	.350G	10MA	110V	35	25.000A
2N5465	P	G	MOT	605	TO 3	140	120	2.5	60.000A	120.000W	110J	.350G	10MA	140V	35	25.000A
2N5466	P	G	MOT	605	TO 3	110	90	2.5	60.000A	120.000W	110J	.350G	10MA	110V	35	25.000A
2N5467	P	G	MOT	605	TO 3	140	120	2.5	60.000A	120.000W	110J	.350G	10MA	140V	35	

Transistor Type No.	N P S	G P S	Manufacturer	Lead Ident	Out line	Maximum (V)			Maximum		Max. T.(°C)	Frequency Resp.(MHz)	Leakage I _{rev} @ V _{CE}	Gain h _{FE} @ I _C
						V _{BE}	V _{CE}	V _{CE(sat)}	I _C	Power				
2N5635			SEE RF POWER SECTION											
2N5636			SEE RF POWER SECTION											
2N5637			SEE RF POWER SECTION											
2N5641			SEE RF POWER SECTION											
2N5642			SEE RF POWER SECTION											
2N5643			SEE RF POWER SECTION											
2N5644			SEE RF POWER SECTION											
2N5645			SEE RF POWER SECTION											
2N5646			SEE RF POWER SECTION											
2N5671	N	S	RCA	605	TO 3	120	90	7.0	30.000A	140.000W	200J	50.000G	10MA 80V	45 15.000A
2N5672	N	S	RCA	605	TO 3	150	120	7.0	30.000A	140.000W	200J	50.000G	10MA 80V	45 20.000A
2N5683	P	S	MOT	605	TO 3	80	60	5.0	50.000A	300.000W	200C	2.000G	2MA 60V	3D 25.000A
2N5684	P	S	MOT	605	TO 3	80	60	5.0	50.000A	300.000W	200C	2.000G	2MA 80V	3D 25.000A
2N5685	P	S	MOT	605	TO 3	80	60	5.0	50.000A	300.000W	200C	2.000G	2MA 60V	3D 25.000A
2N5686	N	S	MOT	605	TO 3	80	80	5.0	50.000A	300.000W	200C	2.000G	2MA 80V	3D 25.000A
2N5687			SEE RF POWER SECTION											
2N5688			SEE RF POWER SECTION											
2N5689			SEE RF POWER SECTION											
2N5690			SEE RF POWER SECTION											
2N5691			SEE RF POWER SECTION											
2N5697			SEE RF POWER SECTION											
2N5698			SEE RF POWER SECTION											
2N5699			SEE RF POWER SECTION											
2N5700			SEE RF POWER SECTION											
2N5701			SEE RF POWER SECTION											
2N5702			SEE RF POWER SECTION											
2N5703			SEE RF POWER SECTION											
2N5704			SEE RF POWER SECTION											
2N5705			SEE RF POWER SECTION											
2N5706			SEE RF POWER SECTION											
2N5707			SEE RF POWER SECTION											
2N5708			SEE RF POWER SECTION											
2N5709			SEE RF POWER SECTION											
2N5710			SEE RF POWER SECTION											
2N5711			SEE RF POWER SECTION											
2N5712			SEE RF POWER SECTION											
2N5713			SEE RF POWER SECTION											
2N5714			SEE RF POWER SECTION											
2N5715			SEE RF POWER SECTION											
2N5729	N	S	FSC	211	TO 5	100	80	5.0	5.000A	10.000W	200J	30.000G	1MA 100V	105 2.000A
2N5730	N	S	FSC	560	TO 59	100	80	5.0	10.000A	45.000W	200J	30.000G	1MA 100V	105 2.000A
2N5731	N	S	FSC	560	TO 61	100	80	5.0	20.000A	75.000W	200J	30.000G	1MA 100V	105 5.000A
2N5732	N	S	FSC	605	TO 3	100	80	5.0	20.000A	75.000W	200J	30.000G	1MA 100V	105 5.000A
2N5761			SEE RF POWER SECTION											
2N5762			SEE RF POWER SECTION											
2557			SEE 2SA57											
25B189			SEE 25B189											
25A189	P	G	HIT	120	TO 1	16		.5	.015A	.080W	85J	8.000B	6UA 12V	56 .001A
25A192	P	G	HIT	120	TO 1	12		.5	.015A	.080W	85J	8.000B	10UA 12V	56 .001A
25A193	P	G	HIT	120	TO 1	16		.5	.015A	.080W	85J	12.000B	6UA 12V	60 .001A
25A194	P	G	HIT	120	TO 1	12		.5	.015A	.080W	85J	12.000B	10UA 12V	60 .001A
25A195	P	G	HIT	120	TO 1	12		.5	.015A	.080W	85J	12.000B	10UA 12V	60 .001A
25A196	P	G	HIT	120	TO 1	12		.5	.015A	.080W	85J	12.000B	10UA 12V	60 .001A
25A197	P	G	HIT	120	TO 1	12		.5	.015A	.080W	85J	12.000B	10UA 12V	60 .001A
25A198	P	G	HIT	120	TO 1	12		.5	.015A	.080W	85J	12.000B	10UA 12V	60 .001A
25A199	P	G	HIT	120	TO 1	12		.5	.015A	.080W	85J	12.000B	10UA 12V	60 .001A
25A200	P	G	HIT	120	TO 1	12		.5	.015A	.080W	85J	12.000B	10UA 12V	60 .001A
25A201	P	G	HIT	120	TO 1	12		.5	.015A	.080W	85J	12.000B	10UA 12V	60 .001A
25A202	P	G	HIT	120	TO 1	12		.5	.015A	.080W	85J	12.000B	10UA 12V	60 .001A
25A203	P	G	HIT	120	TO 1	12		.5	.015A	.080W	85J	12.000B	10UA 12V	60 .001A
25A204	P	G	HIT	120	TO 1	12		.5	.015A	.080W	85J	12.000B	10UA 12V	60 .001A
25A205	P	G	HIT	120	TO 1	12		.5	.015A	.080W	85J	12.000B	10UA 12V	60 .001A
25A206	P	G	HIT	120	TO 1	12		.5	.015A	.080W	85J	12.000B	10UA 12V	60 .001A
25A207	P	G	HIT	120	TO 1	12		.5	.015A	.080W	85J	12.000B	10UA 12V	60 .001A
25A208	P	G	HIT	120	TO 1	12		.5	.015A	.080W	85J	12.000B	10UA 12V	60 .001A
25A209	P	G	HIT	120	TO 1	12		.5	.015A	.080W	85J	12.000B	10UA 12V	60 .001A
25A210	P	G	HIT	120	TO 1	12		.5	.015A	.080W	85J	12.000B	10UA 12V	60 .001A
25A211	P	G	HIT	120	TO 1	12		.5	.015A	.080W	85J	12.000B	10UA 12V	60 .001A
25A212	P	G	HIT	120	TO 1	12		.5	.015A	.080W	85J	12.000B	10UA 12V	60 .001A
25A213	P	G	HIT	120	TO 1	12		.5	.015A	.080W	85J	12.000B	10UA 12V	60 .001A
25A214	P	G	HIT	120	TO 1	12		.5	.015A	.080W	85J	12.000B	10UA 12V	60 .001A
25A215	P	G	HIT	120	TO 1	12		.5	.015A	.080W	85J	12.000B	10UA 12V	60 .001A
25A216	P	G	HIT	120	TO 1	12		.5	.015A	.080W	85J	12.000B	10UA 12V	60 .001A
25A217	P	G	HIT	120	TO 1	12		.5	.015A	.080W	85J	12.000B	10UA 12V	60 .001A
25A218	P	G	HIT	120	TO 1	12		.5	.015A	.080W	85J	12.000B	10UA 12V	60 .001A
25A219	P	G	HIT	120	TO 1	12		.5	.015A	.080W	85J	12.000B	10UA 12V	60 .001A
25A220	P	G	HIT	120	TO 1	12		.5	.015A	.080W	85J	12.000B	10UA 12V	60 .001A
25A221	P	G	HIT	120	TO 1	12		.5	.015A	.080W	85J	12.000B	10UA 12V	60 .001A
25A222	P	G	HIT	120	TO 1	12		.5	.015A	.080W	85J	12.000B	10UA 12V	60 .001A
25A223	P	G	HIT	120	TO 1	12		.5	.015A	.080W	85J	12.000B	10UA 12V	60 .001A
25A224	P	G	HIT	120	TO 1	12		.5	.015A	.080W	85J	12.000B	10UA 12V	60 .001A
25A225	P	G	HIT	120	TO 1	12		.5	.015A	.080W	85J	12.000B	10UA 12V	60 .001A
25A226	P	G	HIT	120	TO 1	12		.5	.015A	.080W	85J	12.000B	10UA 12V	60 .001A
25A227	P	G	HIT	120	TO 1	12		.5	.015A	.080W	85J	12.000B	10UA 12V	60 .001A
25A228	P	G	HIT	120	TO 1	12		.5	.015A	.080W	85J	12.000B	10UA 12V	60 .001A
25A229	P	G	HIT	120	TO 1	12		.5	.015A	.080W	85J	12.000B	10UA 12V	60 .001A
25A230	P	G	HIT	120	TO 1	12		.5	.015A	.080W	85J	12.000B	10UA 12V	60 .001A
25A231	P	G	HIT	120	TO 1	12		.5	.015A	.080W	85J	12.000B	10UA 12V	60 .001A
25A232	P	G	HIT	120	TO 1	12		.5	.015A	.080W	85J	12.000B	10UA 12V	60 .001A
25A233	P	G	HIT	120	TO 1	12		.5	.015A	.080W	85J	12.000B	10UA 12V	60 .001A
25A234	P	G	HIT	120	TO 1	12		.5	.015A	.080W	85J	12.000B	10UA 12V	60 .001A
25A235	P	G	HIT	120	TO 1	12		.5	.015A	.080W	85J	12.000B	10UA 12V	60 .001A
25A236	P	G	HIT	120	TO 1	12		.5	.015A	.080W	85J	12.000B	10UA 12V	60 .001A
25A237	P	G	HIT	120	TO 1	12		.5	.015A	.080W	85J	12.000B	10UA 12V	60 .001A
25A238	P	G	HIT	120	TO 1	12		.5	.015A	.080W	85J	12.000B	10UA 12V	60 .001A
25A239	P	G	HIT	120	TO 1	12		.5	.015A	.080W	85J	12.000B	10UA 12V	60 .001A
25A240	P	G	HIT	120	TO 1	12		.5	.015A	.080W	85J	12.000B	10UA 12V	60 .001A
25A241	P	G	HIT	120	TO 1	12		.5	.015A	.080W	85J	12.000B	10UA 12V	60 .001A
25A242	P	G	HIT	120	TO 1	12		.5	.015A	.080W	85J	12.000B	10UA 12V	60 .001A
25A243	P	G	HIT	120	TO 1	12		.5	.015A	.080W	85J	12.000B	10UA 12V	60 .001A
25A244	P	G	HIT	120	TO 1	12		.5	.015A	.080W	85J	12.000B	10UA 12V	60 .001A
25A245	P	G	HIT	120	TO 1	12		.5	.015A	.080W	85J	12.000B	10UA 12V	60 .001A
25A246	P	G	HIT	120	TO 1	12		.5	.015A	.080W	85J	12.000B	10UA 12V	60 .001A
25A247	P	G	HIT	120	TO 1	12		.5	.015A	.080W	85J	12.000B	10UA 12V	60 .001A
25A248	P	G	HIT	120	TO 1	12		.5	.015A	.080W	85J	12.000B	10UA 12V	60 .001A
25A249	P	G	HIT	120	TO 1	12		.5	.015A	.080W	85J	12.000B	10UA 12V	60 .001A
25A250	P	G	HIT	120	TO 1	12		.5	.015A	.080W	85J	12.000B	10UA 12V	60 .001A
25A251	P	G	HIT	120	TO 1	12		.5	.015A	.080W	85J	12.000B	10UA 12V	60 .001A
25A252	P	G	HIT	120	TO 1	12								

Transistor Type No.	N P S	G S	Manufacturer	Lead Ident	Out line	Maximum (V)			Maximum		Max. T.(C)	Frequency Resp.(MHz)	Leakage		Gain
						V _{CE}	V _{ES}	V _{ES}	I _C	Power			I _{BO}	I _{CE}	
2SA211	P	G	HIT	210	TO 5	18	12R	10.0	.100A	.120W	85J	4.000B	10UA	12V	50
2SA212	P	G	HIT	210	TO 5	25	15	12.0	.100A	.120W	85J	4.000B	5UA	12V	50
2SA217	P	G	HIT	210	TO 5	25	15	12.0	.100A	.120W	85J	4.000B	5UA	12V	50
2SA219	P	G	SAN	120	120J	20		1.5	.015A	.070W	75J	50.000G	15UA	15V	100
2SA221	P	G	SAN	120	120J	20		1.5	.015A	.070W	75J	50.000G	15UA	15V	180
2SA222	P	G	SAN	120	120J	20		1.5	.015A	.070W	75J	50.000G	15UA	15V	120
2SA223	P	G	SAN	120	120J	20		1.5	.015A	.070W	75J	50.000G	15UA	15V	120
2SA229	P	G	TOS	217	TO 17	20		2	.005A	.070W	85J	400.000G	10UA	20V	54
2SA230	P	G	HIT	217	TO 17	20		2	.005A	.070W	85J	400.000G	10UA	20V	54
2SA233	P	G	HIT	128	TO 44	20		5	.010A	.080W	85J	90.000B	30UA	20V	50
2SA234	P	G	HIT	128	TO 44	20		5	.010A	.080W	85J	120.000B	30UA	20V	60
2SA235	P	G	HIT	128	TO 44	20		5	.010A	.080W	85J	135.000B	30UA	20V	80
2SA236	P	G	TOS	128	TO 44	18		5	.005A	.055W	75J	20.000B	12UA	18V	110
2SA237	P	G	TOS	128	TO 44	18		5	.005A	.055W	75J	20.000B	12UA	18V	110
2SA239	P	G	TOS	217	TO 17	20		2	.005A	.075W	85J	125.000G	10UA	12V	8
2SA240	P	G	TOS	217	TO 17	20		2	.005A	.075W	85J	125.000G	10UA	12V	42
2SA246	P	G	HIT	128	TO 44	30		5	.030A	.100W	85J	240.000G	13UA	10V	75
2SA247	P	G	HIT	128	TO 44	30		5	.030A	.100W	85J	240.000G	13UA	10V	75
2SA248	P	G	TOS	128	TO 44	10	1.2		.030A	.100W	85J	200.000B	5UA	10V	125
2SA250	P	G	MAT	128	TO 44	40		7	.200A	.125W	75J	25.000B	8UA	12V	68
2SA276	P	G	TOS	217	TO 17	15		2.0	.010A	.050W	75J	50.000G	6UA	12V	68
2SA277	P	G	TOS	210	TO 5	18		12.0	.040A	.065W	75J	3.500B	3UA	12V	64
2SA278	P	G	TOS	210	TO 5	18		12.0	.040A	.065W	75J	3.500B	3UA	12V	84
2SA279	P	G	MAT	210	TO 5	18		12.0	.040A	.065W	75J	11.000B	3UA	12V	84
2SA282	P	G	TOS	210	TO 5	18		12.0	.030A	.250W	75J	150.000G	6UA	12V	124
2SA283	P	G	TOS	210	TO 5	18		12.0	.030A	.250W	75J	3.800W	7UA	12V	60
2SA284	P	G	TOS	210	TO 5	18		12.0	.200A	.150W	75J	6.000B	7UA	12V	60
2SA288	P	G	TOS	210	TO 5	18		12.0	.200A	.150W	75J	10.000B	7UA	12V	76
2SA289	P	G	HIT	75	TO 7	20		5	.010A	.080W	85J	530.000B	30UA	20V	20
2SA290	P	G	HIT	75	TO 7	20		5	.010A	.080W	85J	550.000B	30UA	20V	20
2SA304	P	G	TOS	210	TO 5	18		12.0	.040A	.065W	75J	2.000B	30UA	20V	20
2SA305	P	G	TOS	210	TO 5	18		12.0	.040A	.065W	75J	2.000B	30UA	20V	20
2SA311	P	G	TOS	210	TO 5	18		12.0	.040A	.065W	75J	6.000B	4UA	12V	76
2SA312	P	G	TOS	210	TO 5	18		12.0	.400A	.055W	75J	20.000B	6UA	12V	68
2SA313	P	G	TOS	210	TO 5	18		12.0	.200A	.150W	75J	25.000B	6UA	12V	68
2SA314	P	G	TOS	210	TO 5	18		12.0	.020A	.060W	75J	40.000B	6UA	12V	78
2SA315	P	G	TOS	210	TO 5	18		12.0	.020A	.060W	75J	40.000B	6UA	12V	78
2SA316	P	G	TOS	210	TO 5	18		12.0	.020A	.060W	75J	55.000B	6UA	12V	78
2SA321	P	G	SAN	120	120J	20		1.5	.020A	.060W	75J	75.000B	6UA	12V	78
2SA322	P	G	SAN	120	120J	20		1.5	.015A	.070W	75J	50.000G	15UA	15V	70
2SA323	P	G	SAN	120	120J	20		1.5	.015A	.070W	75J	50.000G	15UA	15V	100
2SA324	P	G	SAN	120	120J	20		1.5	.015A	.070W	75J	50.000G	15UA	15V	120
2SA331	P	G	SAN	120	120J	20		1.5	.015A	.070W	75J	50.000G	15UA	15V	70
2SA338	P	G	MAT	105	105E	20		5	.005A	.050W	75J	50.000G	15UA	15V	100
2SA339	P	G	MAT	105	105E	20		5	.005A	.050W	75J	10.000B	16UA	15V	25
2SA340	P	G	MAT	105	105E	20		5	.005A	.050W	75J	20.000B	16UA	10V	54
2SA341	P	G	MAT	217	TO 72	20		5	.010A	.063W	75J	70.000B	13UA	6V	40
2SA342	P	G	MAT	217	TO 72	20		5	.010A	.063W	75J	70.000B	13UA	6V	40
2SA344	P	G	MAT	128	TO 44	30		5	.030A	.120W	75J	150.000B	13UA	6V	40
2SA350	P	G	HIT	120	TO 1	20		5	.010A	.080W	85J	55.000B	10UA	12V	90
2SA351	P	G	HIT	120	TO 1	20		5	.010A	.080W	85J	45.000B	10UA	12V	70
2SA352	P	G	HIT	120	TO 1	20		5	.010A	.080W	85J	35.000B	10UA	12V	70
2SA353	P	G	HIT	120	TO 1	25		5	.010A	.080W	85J	35.000B	10UA	12V	70
2SA353A	P	G	HIT	120	TO 1	25		5	.010A	.080W	85J	35.000B	10UA	12V	70
2SA354	P	G	HIT	120	TO 1	25		5	.010A	.080W	85J	30.000B	10UA	12V	70
2SA354A	P	G	HIT	120	TO 1	25		5	.010A	.080W	85J	40.000B	10UA	12V	70
2SA355	P	G	HIT	120	TO 1	25		1.0	.010A	.080W	85J	30.000B	10UA	12V	70
2SA355A	P	G	HIT	120	TO 1	25		1.0	.010A	.080W	85J	40.000B	10UA	12V	70
2SA356	P	G	HIT	120	TO 1	50		1.0	.010A	.080W	85J	30.000B	10UA	2V	70
2SA357	P	G	HIT	120	TO 1	9		5	.010A	.080W	85J	25.000B	15UA	9V	80
2SA358	P	G	HIT	120	TO 1	9		5	.010A	.080W	85J	325.000B	15UA	9V	80
2SA372	P	G	TOS	210	TO 18	15		2.0	.050A	.125W	75J	45.000B	12UA	12V	90
2SA377	P	G	MAT	217	TO 72	20		4	.005A	.050W	75J	350.000G	13UA	10V	20
2SA378	P	G	MAT	217	TO 72	20		4	.005A	.050W	75J	240.000G	13UA	10V	20
2SA379	P	G	MAT	217	TO 72	20		4	.005A	.050W	75J	300.000G	13UA	10V	20
2SA385	P	G	MAT	120	TO 1	16		12.0	.010A	.053W	75J	350.000G	13UA	10V	20
2SA389	P	G	OKI	210	TO 5	18		10.0	.010A	.080W	75J	5.900G	12UA	10V	160
2SA392	P	G	OKI	210	TO 5	18		12.0	.200A	.150W	85J	3.000B	6UA	6V	70
2SA393	P	G	OKI	210	TO 5	18		12.0	.200A	.150W	85J	6.000B	6UA	6V	100
2SA393A	P	G	OKI	210	TO 5	18		12.0	.200A	.150W	85J	9.500B	6UA	6V	150
2SA394	P	G	OKI	210	TO 5	18		12.0	.200A	.150W	85J	9.500B	6UA	6V	150
2SA395	P	G	OKI	210	TO 5	18		12.0	.200A	.150W	85J	14.000B	6UA	6V	200
2SA396	P	G	OKI	210	TO 5	18		12.0	.200A	.150W	85J	19.000B	6UA	6V	300
2SA397	P	G	OKI	211	TO 5	15	8	15.0	.200A	.250W	85J	3.000B	20UA	12V	80
2SA398	P	G	OKI	211	TO 5	23	12	15.0	.200A	.250W	85J	5.000B	15UA	12V	100
2SA399	P	G	OKI	211	TO 5	30	15	20.0	.200A	.250W	85J	7.500B	5UA	12V	120
2SA401	P	G	HIT	128	TO 44	30		5	.040A	.130W	85J	230.000B	30UA	30V	70
2SA412	P	G	HIT	120	TO 18	12		2.5	.100A	.150W	85J	60.000G	20UA	30V	70
2SA413	P	G	MAT	212	TO 18	30		20.0	.030A	.275W	75J	300.000G	5UA	5V	100
2SA414	P	G	MAT	212	TO 18	30		20.0	.030A	.275W	75J	4.000G	3UA	5V	100
2SA415	P	G	MAT	212	TO 3	30		20.0	.200A	.150W	85J	6.000G	3UA	5V	200
2SA416	P	G	MAT	605	TO 3	70		1.5	.700A	.150W	85J	6.000G	3UA	5V	200
2SA422	P	G	SAN	120	120J	20		4	.005A	.050W	75J	6.000G	1MA	60V	100
2SA431	P	G	TOS	217	TO 17	20		2	.005A	.050W	85J	31.900G	30UA	20V	25
2SA432	P	G	TOS	217	TO 17	20		2	.005A	.050W	85J	300.000G	10UA	12V	54
2SA433	P	G	TOS	217	TO 17	20		2	.005A	.070W	85J	800.000G	10UA	12V	54
2SA435	P	G	HIT	128	TO 44	18		5	.005A	.055W	75J	34.000G	10UA	12V	56
2SA436	P	G	HIT	280	280A	20		5	.010A	.060W	85J	250.000G	30UA	20V	66
2SA437	P	G	HIT	280	280A	20		5	.010A	.060W	85J	200.000G	30UA	20V	30
2SA438	P	G	HIT	280	280A	20		5	.010A	.060W	85J	270.000G	30UA	20V	30
2SA440	P	G	SAN	79	79A	20		4	.005A	.060W	85J	31.900G	20UA	20V	80
2SA446	P	G	TOS	211	TO 5	15		2.0	.200A	.200W	75J	350.000G	10UA	12V	90
2SA450	P	G	SON	210	210A	12		1.5	.100A	.150W	100J	1600.000G	10UA	10V	48
2SA451	P	G	HIT	210	210A	12		1.5	.100A	.150W	100J	300.000G	3UA	6V	48
2SA452	P	G	HIT	210	210A	12		1.5	.100A	.150W	100J	300.000G	3UA	6V	98
2SA46															

Transistor Type No.	M P S	G S	Manufacturer	Lead Ident	Out- line	Maximum (V)			Maximum		Max. T.(°C)	Frequency Resp.(MHz)	Leakage		Gain	
						V _{CE}	V _{ES}	V _{EB}	I _C	Power			I _{ES} @ V _{CE}	I _{CS} @ I _C		
2SA530	P	S	HIT	210	210A	50	35	5.0	-1.00A	-2.00W	175J	200.000C	1UA	20V	65	0.10A
2SA532	P	S	SAN	211	TO 39	75	75R	5.0	5.000A	-3.00W	175J	40.000C	500A	75V	80	0.10A
2SA535	P	S	SAN	211	TO 39	120	120R	5.0	-7.00A	-3.00W	175J	40.000C	100A	120V	60	0.10A
2SA536	P	S	SAN	211	TO 39	75	75R	5.0	-7.00A	-5.00W	175J	40.000C	100A	75V	50	0.10A
2SA537	P	P	HIT	211	TO 5	60	50	4.0	-7.00A	-7.50W	200J	200.000C			80	0.50A
2SA537A	P	P	HIT	211	TO 5	90	80	4.0	-7.00A	-7.50W	200J	200.000C			80	0.50A
2SB22	P	P	SAN	120	120K	25	60	12.0	-2.00A	-3.00W	85J	1.000C	15UA	20V	150	1.00A
2SB25	P	P	MAT	605	TO 3	15	15R		-5.00A	5.000W	75J	.005E	800UA	15V	30	
2SB27	P	P	SON	605	TO 3	15	15R		-5.00A	5.000W	75J	.005E	800UA	15V	70	
2SB28	P	P	SON	605	TO 3	15	15R		-5.00A	5.000W	75J	.005E	800UA	15V	120	
2SB29	P	P	SON	605	TO 3	15	15R		-5.00A	5.000W	75J	.005E	800UA	15V	70	
2SB30	P	P	SON	605	TO 3	15	15R		-5.00A	5.000W	75J	.005E	800UA	15V	120	
2SB31	P	P	SON	120	TO 1	40		12.0	-1.00A	0.80W	75J	.700B	10UA	12V	94	1.00A
2SB40	P	P	TOS	120	TO 1	25	12.0		-0.50A	1.50W	75J	1.000B	10UA	12V	68	0.50A
2SB43	P	P	TOS	120	TO 1	45	12.0		-0.50A	0.80W	75J	5.00B	10UA	12V	156	0.01A
2SB43A	P	P	TOS	120	TO 1	25	12.0		-0.50A	0.80W	75J	1.000B	14UA	25V	156	0.01A
2SB44	P	P	TOS	120	TO 1	25	12.0		-0.50A	1.40W	65J	1.000B	16UA	16V	40	
2SB47	P	P	SON	210	TO 5	16	16R		-1.00A	1.40W	65J	1.000B	16UA	16V	80	
2SB48	P	P	SON	210	TO 5	16	16R		-1.00A	1.40W	65J	1.000B	16UA	16V	130	
2SB49	P	P	SON	210	TO 5	30	20R		-2.00A	2.00W	85J	1.000B	16UA	30V	40	
2SB50	P	P	SON	210	TO 5	30	20R		-2.00A	2.00W	85J	1.300B	16UA	30V	80	
2SB51	P	P	SON	210	TO 5	30	20R		-2.00A	2.00W	85J	1.300B	16UA	30V	80	
2SB52	P	P	SON	210	TO 5	30	25	15.0	-2.50A	2.00W	85J	1.300B	14UA	30V	74	0.01A
2SB53	P	P	SON	120	TO 1	30		12.0	-1.50A	1.50W	75J	1.000B	14UA	30V	80	0.50A
2SB54	P	P	TOS	120	TO 1	60		12.0	-1.50A	1.50W	75J	1.000B	14UA	30V	80	0.50A
2SB55	P	P	TOS	120	TO 1	30		12.0	-1.50A	1.50W	75J	1.000B	14UA	30V	80	0.50A
2SB55S	P	P	TOS	120	TO 1	45		12.0	-1.50A	1.50W	75J	1.000B	14UA	30V	80	0.50A
2SB56	P	P	TOS	605	605C	60		12.0	-5.00A	4.000W	75J	4.00B	70UA	12V	62	5.00A
2SB62	P	P	TOS	605	605C	32		12.0	-5.00A	4.000W	75J	4.00B	70UA	12V	62	5.00A
2SB63	P	P	TOS	605	605C	32		12.0	-6.000A	25.000W	75J	1.000B	330UA	12V	78	1.000A
2SB64	P	P	TOS	120	TO 1	30		12.0	-0.70A	1.50W	85J	5.00B	14UA	30V	70	
2SB66	P	P	HIT	55	55B	55	32	12.0	-1.50A	1.85W	70J	1.000B	10UA	30V	45	
2SB67	P	P	HIT	55	55B	60	30.0	15.0	-1.85W	1.85W	70J	1.000B	10UA	30V	45	
2SB67A	P	P	HIT	170B	170B	105	5.0	1.0	-1.00A	0.50W	85J	3.50B	14UA	25V	50	
2SB68	P	P	HIT	170B	TO 3	60		1.0	-6.000A	25.000W	75J	1.000B	330UA	12V	78	1.000A
2SB69	P	P	TOS	120	TO 1	18		12.0	-0.40A	0.65W	85J	1.000B	7UA	12V	80	0.01A
2SB73	P	P	MAT	120	TO 1	25		12.0	-1.00A	1.50W	85J	2.000B	14UA	30V	70	0.01A
2SB75	P	P	MAT	120	TO 1	45		12.0	-1.00A	1.50W	85J	2.000B	25UA	45V	70	0.01A
2SB75A	P	P	MAT	120	TO 1	12		2.5	-1.00A	1.50W	85J	2.000B	14UA	30V	70	
2SB76	P	P	HIT	120	TO 1	12		2.5	-1.00A	1.50W	85J	1.000B	10UA	30V	80	0.50A
2SB77	P	P	MAT,HIT	120	TO 1	45		12.0	-1.00A	1.50W	85J	1.000B	10UA	30V	80	0.50A
2SB77A	P	P	MAT,HIT	120	TO 1	12		2.5	-1.00A	1.50W	85J	1.000B	14UA	30V	100	
2SB78	P	P	HIT	120	TO 1	60		12.0	-1.00A	1.50W	85J	1.000B	14UA	30V	100	
2SB80	P	P	HIT	605	605C	25		10.0	-1.000A	4.000W	60A	AUD	400UA	25V	70	
2SB81	P	P	HIT	605	605C	80	60	12.0	-5.00A	2.000W	70J		50UA	50V	70	
2SB81	P	P	HIT	605	605C	100	60	12.0	-5.00A	2.000W	70J		35UA	50V	70	
2SB82	P	P	HIT	605	605C	100	60	12.0	-3.000A	12.000W	80J	AUD	50UA	50V	70	
2SB83	P	P	HIT	605	TO 3	40	32S	10.0	-1.00A	1.20W	85J	AUD	50UA	30V	55	3.000A
2SB84	P	P	MAT	605	TO 3	60		10.0	-1.50A	.250W	85J	AUD	16UA	30V	66	1.50A
2SB89	P	P	HIT	55	55B	25		12.0	-1.50A	.250W	85J	AUD	50UA	45V	66	1.50A
2SB89A	P	P	HIT	55	55B	45	45S	12.0	-1.50A	.250W	85J	1.000B	14UA	25V	66	1.50A
2SB84	P	P	TOS	120	TO 1	25		12.0	-0.50A	1.50W	75J	1.000B	14UA	25V	76	3.000A
2SB126	P	P	MAT	605	TO 3	32		10.0	-3.500A	30.000W	90J	AUD	220UA	14V	56	3.000A
2SB127	P	P	MAT	605	TO 3	80		40.0	-6.000A	30.000W	90J	AUD	220UA	14V	28	6.000A
2SB128	P	P	MAT	605	TO 3	80		40.0	-6.000A	30.000W	90J	AUD	220UA	14V	28	6.000A
2SB128A	P	P	MAT	605	TO 3	80		40.0	-6.000A	30.000W	90J	AUD	220UA	14V	50	6.000A
2SB129	P	P	MAT	605	TO 3	120		40.0	-1.500A	6.500W	75J	AUD	100UA	14V	50	0.04A
2SB130	P	P	MAT	605	605A	32		10.0	-1.500A	12.000W	85J	.005E	600UA	40V	74	
2SB140	P	P	SON	605	TO 3	40	20	12.0	-1.500A	12.000W	85J	.005E	600UA	40V	74	
2SB141	P	P	SON	605	TO 3	30	30R		-1.000A	10.000W	85J	.005E	1MA	30V	24	
2SB142	P	P	SON	605	TO 3	30	30R		-1.000A	10.000W	85J	.005E	1MA	30V	38	
2SB143	P	P	SON	605	TO 3	30	30R		-1.000A	10.000W	85J	.005E	1MA	30V	76	
2SB144	P	P	SON	605	TO 3	30	30R		-1.000A	10.000W	85J	.005E	1MA	30V	76	
2SB145	P	P	SON	605	TO 3	30	30R		-1.000A	10.000W	85J	.005E	1MA	30V	76	
2SB146	P	P	SON	605	TO 3	30	30R		-1.000A	10.000W	85J	.005E	1MA	30V	76	
2SB150	P	P	TOS,MAT	605	TO 3	40		30.0	-0.800A	25.000W	75J	25.0B	230UA	12V	65	8.000A
2SB155	P	P	TOS	120	TO 1	16		2.5	-3.00A	4.50W	85J	AUD	14UA	12V	28	0.05A
2SB156	P	P	HIT	120	TO 1	16		2.5	-3.00A	4.50W	85J	AUD	14UA	12V	28	0.05A
2SB156A	P	P	HIT	120	TO 1	20	20S	6.0	-3.00A	4.50W	85J	AUD	14UA	12V	70	1.50A
2SB157	P	P	MAT	105	105B	7		7.0	-0.05A	0.10W	55J	VI0AMP	100UA	1V	35	
2SB158	P	P	MAT	105	105B	7		7.0	-0.05A	0.10W	55J	VI0AMP	100UA	1V	80	
2SB159	P	P	MAT	105	105B	7		7.0	-0.05A	0.10W	55J	VI0AMP	120UA	2V	75	
2SB160	P	P	MAT	120	TO 1	32		10.0	-0.10A	1.25W	75J	VI0AMP	3UA	10V	50	
2SB170	P	P	MAT	120	TO 1	32		10.0	-0.125A	1.25W	75J	VI0AMP	3UA	10V	50	
2SB171	P	P	MAT	120	TO 1	32		10.0	-0.10A	1.25W	75J	VI0AMP	12UA	10V	50	0.02A
2SB172	P	P	MAT	120	TO 1	32		10.0	-0.10A	1.25W	75J	VI0AMP	3UA	10V	60	
2SB173	P	P	MAT	120	TO 1	32		10.0	-0.10A	1.25W	75J	VI0AMP	3UA	10V	100	
2SB176	P	P	MAT	120	TO 1	32		10.0	-0.125A	1.25W	75J	VI0AMP	12UA	10V	90	0.02A
2SB177	P	P	MAT	120	TO 1	60		10.0	-0.125A	1.25W	75J	VI0AMP	20UA	12V	96	3.00A
2SB178	P	P	MAT	120	120G	20		6.0	-3.00A	2.25W	75J	VI0AMP	20UA	12V	96	3.00A
2SB178A	P	P	MAT	120	120G	60		6.0	-3.00A	2.25W	75J	VI0AMP	20UA	12V	66	3.00A
2SB178B	P	P	MAT	120	120G	25		12.0	-1.50A	2.00W	85J	10.000B	15UA	20V	100	
2SB185	P	P	SAN	120	120J	25		12.0	-1.50A	2.00W	85J	1.000B	15UA	20V	100	
2SB186	P	P	SAN	120	120J	25		12.0	-1.50A	2.00W	85J	1.000B	15UA	20V	100	0.30A
2SB187	P	P	SAN	120	120J	25		12.0	-1.50A	2.00W	85J	10.000B	15UA	20V	100	
2SB188	P	P	SAN	120	120F	25		12.0	-2.50A	2.00W	75J	1.000B	14UA	25V	80	1.00A
2SB189	P	P	TOS	170	170K	32		12.0	-4.00A	2.50W	75J	5.00B	40UA	12V	68	1.50A
2SB200	P	P	TOS	170	170K	45		12.0	-4.00A	3.00W	75J	8.00B	40UA	12V	68	1.50A
2SB200A	P	P	TOS	170	170K	45		12.0	-4.00A	3.00W	75J	5.00B	30UA			

Transistor Type No.	N P S	Manufacturer	Lead Ident	Out- line	Maximum (V)			Maximum		Max. T.(°C)	Frequency Resp.(MHz)	Leakage		Gain β_{DC} @ I_C
					V_{CE}	V_{BE}	V_{ES}	I_C	Power			I_{B1} @ V_{CE}	I_{B2} @ V_{CE}	
2SB237	P	G TOS	405	405A	36	25.0	15.000A	60.000W	85J	3.00B	1MA 12V	90	15.000A	
2SB257	P	G TOS	120	TO 1	18	12.0	0.040A	0.060W	75J	5.000B	3UA 12V	100	0.01A	
2SB258	P	G TOS	405	405A	120	1.0	15.000A	60.000W	75J	1.500B	4MA 12V	108	5.000A	
2SB259	P	G TOS	405	405A	80	1.0	15.000A	60.000W	75J	1.500B	4MA 12V	108	5.000A	
2SB260	P	G TOS	405	405A	50	1.0	15.000A	60.000W	75J	1.500B	4MA 12V	108	5.000A	
2SB265	P	G TOS	210	TO 5	40	12.0	0.040A	0.060W	75J	1.500B	4MA 12V	108	5.000A	
2SB274	P	G HIT	605	TO 3	120	80	1.5	6.000A	50.000W	91J	1.000B	10UA 12V	94	1.000A
2SB275	P	G HIT	605	TO 3	120	105	1.5	6.000A	50.000W	91J	1.000B	1MA 30V	70	1.000A
2SB276	P	G HIT	605	TO 3	120	105	1.5	6.000A	50.000W	91J	1.000B	1MA 30V	70	1.000A
2SB282	P	G MAT	605	TO 3	60	20.0	6.000A	30.000W	90J	2.50G	100UA 1V	30	6.000A	
2SB283	P	G MAT	605	TO 3	60	20.0	6.000A	30.000W	90J	2.50G	100UA 1V	30	6.000A	
2SB285	P	G MAT	605	TO 3	60	20.0	6.000A	30.000W	90J	2.50G	100UA 1V	40	6.000A	
2SB290	P	G TOS	605	TO 3	80	40.0	6.000A	30.000W	90J	2.50G	100UA 1V	40	6.000A	
2SB291	P	G TOS	210	TO 5	18	12.0	0.040A	0.065W	75J	5.000B	4UA 12V	100	0.01A	
2SB292	P	G TOS	210	TO 5	30	12.0	0.150A	0.150W	75J	1.000B	10UA 12V	78	0.01A	
2SB292A	P	G TOS	210	TO 5	60	12.0	0.150A	0.150W	75J	1.000B	10UA 12V	72	0.050A	
2SB296	P	G TOS	605	TO 3	130	3.0	10.000A	35.000W	75J	3.00B	1MA 50V	64	1.000A	
2SB302	P	G HIT	120	TO 1	10	5.0	0.022A	0.020W	60A	0.07B	6UA 12V	80		
2SB303	P	G SAN	120	120Q	25	12.0	0.020A	0.10W	85J	1.000B	15UA 20V	100		
2SB306	P	G MAT	605	TO 5	105	50.0	0.020A	0.10W	85J	1.000B	15UA 20V	100		
2SB307	P	G MAT	210	TO 3	75	1.0	8.000A	30.000W	90J	0.17E	220UA 1V	56	1.000A	
2SB309A	P	G MAT	605	TO 3	75	1.0	8.000A	30.000W	90J	0.17E	150UA 1V	62	1.000A	
2SB324	P	G MAT	605	TO 3	60R	1.0	8.000A	30.000W	90J	0.17E	150UA 1V	62	1.000A	
2SB331	P	G HIT	405	TO 36	40	25	20.0	15.000A	80.000W	100J	35.0B	4MA 40V	70	
2SB332	P	G HIT	405	TO 36	60	45	40.0	15.000A	80.000W	100J	35.0B	4MA 40V	70	
2SB333	P	G HIT	405	TO 36	80	55	40.0	15.000A	80.000W	100J	35.0B	4MA 40V	70	
2SB334	P	G HIT	405	TO 36	100	65	60.0	15.000A	80.000W	100J	35.0B	4MA 40V	70	
2SB335	P	G MAT	105	105E	40	10.0	0.080A	0.083W	75J	AUO	10UA 10V	60		
2SB336	P	G MAT	605	TO 3	40	30R	1.0	7.000A	12.000W	91J	AUO	10UA 10V	72	
2SB337	P	G HIT	605	TO 3	60	10.0	7.000A	12.000W	91J	AUO	10UA 10V	90	1.000A	
2SB338	P	G HIT	605	TO 3	80	35	50.0	10.000A	12.000W	90J	25.0B	250UA 30V	110	
2SB340	P	G HIT	605	TO 3	100	40	50.0	10.000A	12.000W	90J	25.0B	250UA 30V	50	
2SB341	P	G SAN	605	TO 3	120	50.0	10.000A	30.000W	85J	1.500B	250UA 30V	50		
2SB342	P	G SAN	605	TO 3	120	120R	1.0	6.000A	30.000W	85J	1.500B	250UA 30V	50	
2SB343	P	G SAN	605	TO 3	150	150R	1.0	6.000A	30.000W	85J	1.500B	250UA 30V	50	5.000A
2SB345	P	G MAT	120	TO 1	32	10.0	0.100A	0.165W	75J	0.17E	10UA 10V	124	5.000A	
2SB346	P	G MAT	120	TO 1	32	10.0	0.100A	0.165W	75J	0.17E	10UA 10V	180		
2SB347	P	G MAT	120	TO 1	32	10.0	0.100A	0.165W	75J	0.17E	10UA 10V	124		
2SB348	P	G MAT	120	TO 1	32	10.0	0.100A	0.165W	75J	0.17E	10UA 10V	124		
2SB351	P	G HIT	605	TO 3	80	40	1.0	5.000A	12.000W	90J	5.000B	500UA 40V	14	
2SB362	P	G HIT	605	TO 3	80	40	1.0	5.000A	12.000W	90J	5.000B	500UA 40V	14	
2SB364	P	G TOS	120	TO 1	20	12.0	4.000A	1.50W	75J	1.000B	14UA 20V	98	100A	
2SB365	P	G TOS	120	TO 1	20	12.0	4.000A	1.50W	75J	1.000B	14UA 20V	98	100A	
2SB367	P	G HIT	605	605B	25	20	12.0	1.000A	4.000W	85J	5.00B	100UA 20V	58	100A
2SB368	P	G HIT	605	605B	45	35	12.0	1.000A	4.000W	85J	5.00B	100UA 20V	58	100A
2SB370	P	G HIT	120	TO 1	25	18	6.0	5.00A	2.00W	85J	AUO	20UA 12V	150	150A
2SB371	P	G MAT	120	TO 1	32	25	12.0	5.00A	2.00W	85J	AUO	20UA 12V	150	150A
2SB372	P	G SAN	605	TO 3	150	150R	1.0	9.000A	30.000W	85J	1.500B	15UA 10V	120	0.500A
2SB376	P	G SAN	120	120G	20	6.0	3.00A	2.25W	75J	AUO	20UA 12V	50	8.000A	
2SB377	P	G SON	212	TO 5	18	16R	1.50A	2.70W	85J	1.400B	10UA 32V	120	0.20A	
2SB378	P	G SON	212	TO 5	18	16R	1.50A	2.70W	85J	1.300B	10UA 18V	44	0.20A	
2SB379	P	G SON	212	TO 5	18	16R	1.50A	1.80W	85J	1.500B	10UA 18V	90	0.20A	
2SB380	P	G SON	212	TO 5	18	16R	1.50A	1.80W	85J	1.700B	10UA 18V	100	0.20A	
2SB381	P	G SON	212	TO 5	32	30R	3.00A	2.70W	85J	1.300B	10UA 32V	44	0.20A	
2SB382	P	G SON	212	TO 5	32	30R	3.00A	2.70W	85J	1.500B	10UA 32V	90	0.20A	
2SB383	P	G SAN	605	TO 3	80	80R	1.0	6.000A	30.000W	85J	1.500B	10UA 32V	90	0.20A
2SB390	P	G SAN	605	TO 3	30	30R	1.0	6.000A	30.000W	85J	1.500B	5MA 50V	75	3.000A
2SB391	P	G SAN	605	TO 3	50	50R	1.0	6.000A	30.000W	85J	1.500B	5MA 50V	75	3.000A
2SB392	P	G OKI	210	TO 5	28	20S	13.0	2.00A	1.50W	85J	7UA 12V	100		
2SB393	P	G OKI	210	TO 5	28	20S	13.0	2.00A	1.50W	85J	7UA 12V	44		
2SB394	P	G OKI	210	TO 5	28	20S	13.0	2.00A	1.50W	85J	7UA 12V	44		
2SB395	P	G OKI	210	TO 5	28	20S	13.0	2.00A	1.50W	85J	7UA 12V	160		
2SB396	P	G OKI	210	TO 5	40	40S	13.0	2.00A	1.50W	85J	7UA 12V	68		
2SB400	P	G SAN	120	120Q	20	10.0	0.040A	0.100W	85J	1.000B	15UA 20V	120		
2SB401	P	G MAT	212	TO 5	40	20.0	3.00A	2.40W	85J	3.00G	10UA 10V	40	6.00A	
2SB402	P	G MAT	212	TO 5	60	10.0	3.00A	2.40W	85J	3.00G	10UA 10V	40	6.00A	
2SB403	P	G SAN	120	120Q	25	10.0	1.000A	7.20W	85J	7.50B	50UA 20V	120	2.00A	
2SB405	P	G SAN	605	TO 3	80	360	1.0	15.000A	40.000W	85J	3.00G	250UA 30V	60	1.000A
2SB410	P	G SAN	605	TO 3	60	360	1.0	15.000A	40.000W	85J	1.000G	100UA 12V	66	5.00A
2SB411	P	G SAN	605	TO 3	60	360	1.0	15.000A	40.000W	85J	1.000G	100UA 12V	66	5.00A
2SB412	P	G TOS	210	TO 5	25	25S	13.0	2.00A	1.50W	85J	1.000B	14UA 12V	86	3.00A
2SB414	P	G TOS	210	TO 5	45	45S	13.0	2.00A	1.50W	85J	1.000B	10UA 12V	70	
2SB415	P	G TOS	210	TO 5	70	70S	13.0	2.00A	1.50W	85J	1.000B	10UA 12V	70	
2SB418	P	G HIT	605	605B	45	1.5	1.500A	6.000W	100J	AUO	250UA 12V	100	5.00A	
2SB419	P	G HIT	605	605B	80	4.0	6.00A	3.00W	85J	2.500B	50UA 50V	68	1.50A	
2SB421	P	G TOS	605	TO 3	80	40.0	3.000A	30.000W	85J	3.00B	160UA 12V	62	1.000A	
2SB422	P	G TOS	605	TO 3	60	1.2	3.000A	30.000W	85J	3.00B	160UA 12V	64	1.000A	
2SB425	P	G TOS	605	TO 3	32	1.2	3.000A	30.000W	85J	3.00B	160UA 12V	64	1.000A	
2SB439	P	G TOS	120	TO 1	30	12.0	0.150A	0.150W	75J	2.000B	14UA 12V	140	0.01A	
2SB440	P	G TOS	120	TO 1	30	12.0	0.150A	0.150W	75J	2.000B	14UA 12V	140	0.01A	
2SB443	P	G HIT	120	TO 1	18	12.0	0.10A	0.100W	85J	3.000B	10UA 12V	150	0.01A	
2SB444	P	G HIT	120	TO 1	18	12.0	0.10A	0.100W	85J	3.000B	7UA 12V	160	0.01A	
2SB448	P	G MAT	605	605A	32	10.0	3.000A	13.000W	90J	0.15E	1MA 32V	50	1.000A	
2SB449	P	G MAT	605	TO 3	55	20.0	3.500A	22.500W	100J	0.10E	3MA 14V	86	0.03A	
2SB459	P	G HIT	120	TO 1	40	25R	2.5	0.500A	1.20W	200J	AUO	12UA 20V	180	0.01A
2SB460	P	G HIT	805	TO 3	200	1.5	10.000A	10.000W	85J	HOROSC	500UA 30V	46	4.000A	
2SB468	P	G HIT	605	TO 3	270	1.5	10.000A	10.000W	85J	AUO	500UA 30V	46	4.000A	
2SB471	P	G HIT	605	TO 3	60	45R	10.0	10.000A	30.000W	90J	3.00B	500UA 30V	90	1.000A
2SB472	P	G MAT	605	605F	32	6.0	1.500A	4.30W	85J	0.15E	15UA 10V	100	1.000A	
2SB474	P	G SAN	605	605C	35	35R	6.0	2.000A	12.000W	85J	AUO	200UA 25V	100	5.00A
2SB475	P	G MAT	120	TO 1	20	6.0	0.300A	0.150W	75J	AUO	20UA 12V	60	1.50A	
2SB492	P	G SAN	211	TO 39	25	25R	10.0	3.000A	6.000W	90J	0.15E	1MA 32V	50	1.000A
2SB496	P	G HIT	120	TO 1	25	18R	2.5	2.50A	300W	85J	AUO	50UA 20V	100	2.00A
2SC13	N	G TOS	210	TO 5	18	12.0	0.040A	0.0						

Transistor Type No.	N P S	G S	Manufacturer	Lead Ident	Out- line	Maximum (V)			Maximum		Max. T.(°C)	Frequency Resp.(MHz)	Leakage		Gain h _{FE} @ I _C		
						V _{CE}	V _{ES}	V _{ES}	I _C	Power			I _{ES} @ V _{CE}	I _{ES}			
2SC367	N	S	TOS	45	45C	40	5.0	4.0A	.300W	125J	100.000B	500NA	18V	180	.100A		
2SC368	N	S	TOS	210	TO 18	25	5.0	1.0A	.250W	175J	100.000G	100NA	18V	350	.001A		
2SC370	N	S	TOS	45	45C	35	5.0	1.0A	.200W	125J	100.000G	100NA	18V	350	.001A		
2SC371	N	S	TOS	45	45C	35	4.0	1.0A	.200W	125J	80.000G	500NA	18V	350	.001A		
2SC372	N	S	TOS	45	45C	35	4.0	1.0A	.200W	125J	80.000G	500NA	18V	80	.002A		
2SC373	N	S	TOS	45	45C	35	4.0	1.0A	.200W	125J	80.000G	500NA	18V	140	.002A		
2SC374	N	S	TOS	45	45C	35	4.0	1.0A	.200W	125J	80.000G	500NA	18V	276	.002A		
2SC376	N	S	TOS	45	45C	35	4.0	1.0A	.200W	125J	80.000G	500NA	18V	500	.002A		
2SC382	N	S	TOS	45	45C	40	4.0	1.0A	.200W	125J	100.000G	1UA	18V	60	.002A		
2SC387	N	S	TOS	45	45C	40	2.0	.050A	.150W	125J	250.000G	500NA	18V	60	.004A		
2SC400	N	S	TOS	210	TO 18	30	5.0	1.0A	.250W	125J	500.000G	500NA	15V	40	.008A		
2SC402	N	S	SON	50	50C	50	25	3.0	1.0A	100W	120J	100.000G	200NA	25V	118	.010A	
2SC403	N	S	SON	50	50C	50	25	3.0	1.0A	100W	120J	100.000G	200NA	25V	90	.010A	
2SC404	N	S	SON	50	50C	50	25	3.0	1.0A	100W	120J	100.000G	200NA	25V	60	.010A	
2SC423	N	S	SAN	211	TO 39	40	10	5.0	1.0A	100W	120J	100.000G	200NA	25V	90	.010A	
2SC424	N	S	SAN	211	TO 39	40	10	5.0	1.0A	100W	120J	100.000G	200NA	25V	90	.010A	
2SC425	N	S	SAN	211	TO 39	40	10	5.0	1.0A	100W	120J	100.000G	200NA	25V	90	.010A	
2SC426	N	S	SAN	211	TO 39	40	10	5.0	1.0A	100W	120J	100.000G	200NA	25V	90	.010A	
2SC427	N	S	SAN	211	TO 18	40	20	5.0	1.0A	100W	120J	100.000G	1UA	35V	80	.020A	
2SC428	N	S	SAN	211	TO 18	40	20	5.0	1.0A	100W	120J	100.000G	1UA	35V	80	.020A	
2SC454	N	S	HIT	211	TO 18	20	10	5.0	1.0A	.300W	175J	350.000G	1UA	15V	80	.020A	
2SC455	N	S	HIT	50	50A	30	5.0	1.0A	.200W	125J	230.000G	500NA	18V	150	.002A		
2SC456	N	S	HIT	211	TO 5	50	30	1.5	1.0A	.200W	125J	230.000G	500NA	18V	46	.002A	
2SC458	N	S	HIT	50	50A	30	3.0	5.0	1.0A	.200W	125J	230.000G	1UA	12V	20	150	.002A
2SC459	N	S	HIT	50	50A	30	5.0	1.0A	.200W	125J	230.000G	500NA	18V	150	.002A		
2SC460	N	S	HIT	50	50A	30	5.0	1.0A	.200W	125J	230.000G	500NA	18V	110	.002A		
2SC461	N	S	HIT	50	50A	30	5.0	1.0A	.200W	125J	230.000G	500NA	18V	98	.002A		
2SC463	N	S	HIT	211	TO 5	35	5.0	1.0A	.200W	125J	230.000G	500NA	18V	86	.002A		
2SC464	N	S	HIT	280	280A	30	2.0	.050A	.200W	200J	600.000G	500NA	10V	73	.002A		
2SC465	N	S	HIT	280	280A	30	2.0	.050A	.200W	200J	600.000G	500NA	10V	40	.001A		
2SC466	N	S	HIT	280	280A	30	2.0	.050A	.200W	200J	600.000G	500NA	10V	40	.001A		
2SC468	N	S	HIT	170	170J	40	15	5.0	1.0A	.750W	175J	300.000G	500NA	10V	40	.001A	
2SC470-3	N	S	SON	211	211C	90	70	5.0	1.0A	.750W	175J	VIOAMP	1UA	25V	60	.010A	
2SC470-4	N	S	SON	211	211C	120	100	5.0	1.0A	.750W	175J	VIOAMP	1UA	25V	60	.010A	
2SC470-5	N	S	SON	211	211C	150	130	5.0	1.0A	.750W	175J	VIOAMP	1UA	25V	60	.010A	
2SC470-6	N	S	SON	211	211C	180	150	5.0	1.0A	.750W	175J	VIOAMP	1UA	25V	60	.010A	
2SC477	N	S	MAT	217	TO 72	50	5.0	1.0A	.300W	175J	VIOAMP	1UA	25V	60	.001A		
2SC478	N	S	MAT	211	TO 18	50	5.0	1.20A	.300W	175J	150.000G	1UA	10V	85	1.000A		
2SC479	N	S	MAT	217	TO 72	50	5.0	1.20A	.300W	175J	150.000G	1UA	10V	85	1.000A		
2SC481	N	S	TOS	211	TO 5	60	40	5.0	6.00A	.650W	175J	HSSV	1UA	40V	72	1.00A	
2SC492	N	S	TOS	605	TO 3	110	2.0	5.0	1.000A	.800W	150J	100.000G	10UA	30V	46	1.00A	
2SC493	N	S	TOS	605	TO 3	80	5.0	5.0	5.000A	50.000W	150J	20.000B	10MA	50V	70	1.000A	
2SC494	N	S	TOS	605	TO 3	50	5.0	5.0	5.000A	50.000W	150J	20.000B	10MA	50V	70	1.000A	
2SC500	N	S	TOS	211	TO 5	60	5.0	5.0	5.000A	50.000W	150J	20.000B	10MA	50V	70	1.000A	
2SC502	N	S	TOS	605	TO 3	60	5.0	5.0	5.000A	50.000W	150J	20.000B	10MA	50V	70	1.000A	
2SC503	N	S	TOS	211	TO 5	60	5.0	5.0	5.000A	50.000W	150J	20.000B	10MA	50V	70	1.000A	
2SC504	N	S	TOS	605	TO 3	60	5.0	5.0	5.000A	50.000W	150J	20.000B	10MA	50V	70	1.000A	
2SC515	N	S	TOS	211	TO 5	60	5.0	5.0	5.000A	50.000W	150J	20.000B	10MA	50V	70	1.000A	
2SC518	N	S	TOS	605	TO 3	60	5.0	5.0	5.000A	50.000W	150J	20.000B	10MA	50V	70	1.000A	
2SC520A	N	S	TOS	605	TO 3	100	5.0	5.0	5.000A	50.000W	150J	20.000B	10MA	50V	40	5.000A	
2SC521A	N	S	TOS	605	TO 3	70	5.0	5.0	5.000A	50.000W	150J	20.000B	10MA	50V	80	1.000A	
2SC526	N	S	MAT	211	TO 5	165	5.0	5.0	5.000A	50.000W	150J	20.000B	10MA	50V	80	1.000A	
2SC527	N	S	MAT	211	TO 5	165	5.0	5.0	5.000A	50.000W	150J	20.000B	10MA	50V	80	1.000A	
2SC528	N	S	HIT	50	50A	20	3.0	5.0	1.000A	.300W	175J	200.000G	1UA	35V	50	1.000A	
2SC535	N	S	HIT	50	50B	30	5.0	5.0	1.000A	.300W	175J	200.000G	1UA	35V	50	1.000A	
2SC536	N	S	HIT	43	43B	40	20	4.0	1.00A	.150W	125J	180.000G	1UA	15V	80	.001A	
2SC537	N	S	SAN	211	TO 18	45	5.0	5.0	1.00A	.150W	125J	180.000G	1UA	15V	80	.001A	
2SC538	N	S	MAT	211	TO 18	45	5.0	5.0	1.00A	.150W	125J	180.000G	1UA	15V	80	.001A	
2SC538A	N	S	MAT	211	TO 18	45	5.0	5.0	1.00A	.150W	125J	180.000G	1UA	15V	80	.001A	
2SC539	N	S	MAT	211	TO 18	45	5.0	5.0	1.00A	.150W	125J	180.000G	1UA	15V	80	.001A	
2SC544	N	S	SAN	43	43B	40	4.0	4.0	0.30A	.150W	125J	350.000G	1UA	35V	80	.001A	
2SC545	N	S	SAN	43	43B	40	4.0	4.0	0.30A	.150W	125J	350.000G	1UA	35V	80	.001A	
2SC546	N	S	SAN	43	43B	40	4.0	4.0	0.30A	.150W	125J	350.000G	1UA	35V	80	.001A	
2SC562	N	S	MAT	218	TO 18	40	4.0	4.0	0.30A	.150W	125J	350.000G	1UA	35V	80	.001A	
2SC563	N	S	MAT	218	TO 18	40	4.0	4.0	0.30A	.150W	125J	350.000G	1UA	35V	80	.001A	
2SC581	N	S	MAT	217	TO 72	30	5.0	5.0	0.25A	.145W	175J	550.000G	10UA	40V	52	1.000A	
2SC582	N	S	MAT	605	605C	300	3.0	5.0	0.30A	.140W	175J	550.000G	10UA	40V	76	1.000A	
2SC583	N	S	MAT	217	TO 72	30	3.0	5.0	0.25A	.140W	175J	550.000G	10UA	40V	76	1.000A	
2SC585	N	S	MAT	540	TO 60	65	4.0	3.000A	20.000W	175J	1000.000G	12UA	12V	33	2.00A		
2SC586	N	S	MAT	605	TO 3	150	6.0	5.000A	50.000W	175J	1000.000G	12UA	12V	33	5.000A		
2SC587	N	S	MAT	211	TO 18	45	5.0	5.0	0.30A	.300W	175J	50.000G	10UA	40V	300	.003A	
2SC587A	N	S	MAT	211	TO 18	45	5.0	5.0	0.30A	.300W	175J	50.000G	10UA	40V	300	.003A	
2SC589	N	S	MAT	211	TO 72	50	5.0	5.0	0.30A	.165W	175J	150.000G	1UA	100	.001A		
2SC593	N	S	MAT	211	TO 72	50	5.0	5.0	0.30A	.165W	175J	150.000G	1UA	100	.001A		
2SC597	N	S	MAT	211	TO 72	50	5.0	5.0	0.30A	.165W	175J	150.000G	1UA	100	.001A		
2SC598	N	S	MAT	211	TO 72	50	5.0	5.0	0.30A	.165W	175J	150.000G	1UA	100	.001A		
2SC600	N	S	MAT	540	TO 60	65	4.0	1.000A	6.000W	175J	300.000G	12UA	30V	30	1.00A		
2SC601	N	S	MAT	540	TO 60	65	4.0	1.000A	6.000W	175J	300.000G	12UA	30V	30	1.00A		
2SC608	N	S	MAT	211	211A	40	5.0	1.00A	1.000W	175J	250.000G	12UA	30V	30	2.00A		
2SC609	N	S	HIT	630	630A	75	4.0	1.000A	1.000W	175J	500.000G	100NA	10V	80	.010A		
2SC611	N	S	MAT	217	TO 72	20	4.0	1.00A	1.000W	175J	500.000G	5UA	40V	40	1.00A		
2SC612	N	S	MAT	217	TO 72	35	2.0	0.20A	.200W	150J	600.000G	5UA	40V	80	.002A		
2SC614	N	S	SAN	211	TO 39	80	60	4.0	1.500A	7.500W	85J	200.000G	100UA	40V	80	.002A	
2SC615	N	S	SAN	211	TO 39	80	60	4.0	1.500A	7.500W	85J	200.000G	100UA	40V	80	.002A	
2SC616	N	S	SAN	170	TO 8	30	20	4.0	1.50A	13.000W	175J	200.000G	100UA	10V	100	.250A	
2SC617	N	S	SAN	170	TO 8	30	20	4.0	1.50A	13.000W	175J						

Transistor Type No.	N P S	Manufacturer	Lead Ident	Out- line	Maximum (V)			Maximum		Max. T.(C)	Frequency Resp.(MHz)	Leakage		Gain	
					V _{CE}	V _{BE}	V _{ES}	I _B	Power			I _{ES} @ V _{ES}	h _{FE} @ I _B		
2T3042		SEE 2SB145.6													
2T3043		SEE 2SB146													
3TE110		SEE 2N4131													
3TE120		SEE 2N4130													
3TE245	-N S	ITT	543	To 60	70	70	4.0	1.000A	23.000W	200J	400.000G	500UA	65V	30	-500A
3TE350	-N S	ITT	632	To 37	70	40	4.0	500A	7.500W	200J	350.000G	100UA	70V	30	-500A
3TE440	-N S	ITT	960	960A	80	80	4.0	1.500A	25.000W	200J	350.000G	100UA	70V	26	-500A
3TE450	-N S	ITT	960	960A	80	80	4.0	500A	7.500W	200J	350.000G	100UA	70V	30	-500A
4C28	-N S	GEC	210	To 5	40	30	2.0	0.25A	.150W	125J	12.000B	2UA	30V	12	
4C29	-N S	GEC	210	To 5	40	30	2.0	0.25A	.150W	125J	12.000B	2UA	30V	12	
4C30	-N S	GEC	210	To 5	40	30	2.0	0.25A	.150W	125J	12.000B	2UA	30V	12	
4C31	-N S	GEC	210	To 5	40	30	2.0	0.25A	.150W	125J	12.000B	2UA	30V	12	
4C43	-N S	GEC	210	To 5	80	1.0		0.60A	6.00W	125J	12.000B	2UA	30V	80	
4D20	-N S	GEC	210	To 5	40	24	1.5	0.25A	.125W	150J		1UA	15V	32	
4D21	-N S	GEC	210	To 5	40	24	1.5	0.25A	.125W	150J		1UA	15V	88	
4D22	-N S	SEE 2N2349													
4D24	-N S	GEC	210	To 5	15	15	1.0	0.25A	.125W	125J		1UA	12V	32	
4D25	-N S	GEC	210	To 5	15	15	1.0	0.25A	.125W	125J		1UA	12V	88	
4D26	-N S	GEC	210	To 5	15	15	1.0	0.25A	.125W	125J		1UA	12V	180	
7A30	-N S	GEC	210	To 5	50	50	5.0	1.000W	150J	8.000B	8.000B	10UA	30V	24	
7A31	-N S	GEC	210	To 5	50	50	5.0	1.000W	150J	8.000B	8.000B	10UA	30V	60	
7A32	-N S	GEC	210	To 5	50	50	5.0	1.000W	150J	8.000B	8.000B	10UA	30V	130	
7B1	-N S	GEC	635	635B	80	60	10.0	15.000W	175J	12.000B	12.000B	50UA	80V	24	
7B2	-N S	GEC	635	635B	80	60	10.0	15.000W	175J	12.000B	12.000B	50UA	80V	60	
7C1	-N S	GEC	675	675A	80	60	10.0	15.000W	175J	12.000B	12.000B	50UA	80V	24	
7C2	-N S	GEC	675	675A	80	60	10.0	15.000W	175J	12.000B	12.000B	50UA	80V	24	
7C3	-N S	GEC	675	675A	120	100	10.0	15.000W	175J	12.000B	12.000B	50UA	120V	24	
7D1	-N S	GEC	676	676A	80	60	10.0	15.000W	175J	12.000B	12.000B	50UA	80V	24	
7D2	-N S	GEC	676	676A	80	60	10.0	15.000W	175J	12.000B	12.000B	50UA	80V	60	
7D3	-N S	GEC	676	676A	120	100	10.0	15.000W	175J	12.000B	12.000B	50UA	120V	24	
7E1	-N S	GEC	680	680A	80	60	10.0	15.000W	175J	12.000B	12.000B	50UA	20V	24	
7E2	-N S	GEC	680	680A	80	60	10.0	15.000W	175J	12.000B	12.000B	50UA	80V	60	
7E3	-N S	GEC	680	680A	120	100	10.0	15.000W	175J	12.000B	12.000B	50UA	120V	24	
7F1	-N S	GEC	530	530B	80	60	10.0	7.000W	175J	12.000B	12.000B	50UA	80V	24	
7F2	-N S	GEC	530	530B	80	60	10.0	15.000W	175J	12.000B	12.000B	50UA	80V	60	
7F3	-N S	GEC	530	530B	120	100	10.0	15.000W	175J	12.000B	12.000B	50UA	120V	24	
7F4	-N S	GEC	530	530B	120	100	10.0	7.000W	175A	20.000B	20.000B	50UA	120V	60	
7G1	-N S	GEC	530	530A	80	60	10.0	15.000W	175J	12.000B	12.000B	50UA	80V	24	
7G2	-N S	GEC	530	530A	80	60	10.0	15.000W	175J	12.000B	12.000B	50UA	80V	60	
7G3	-N S	GEC	530	530A	120	100	10.0	15.000W	175J	12.000B	12.000B	50UA	120V	24	
7G4	-N S	GEC	530	530A	120	100	10.0	15.000W	175A	20.000B	20.000B	50UA	120V	60	
10B551-2	-N S	GEC	785	785A	40	15	5.0	1.00W	125J	300.000G	50NA	15V	60	0.10A	
10B551-3	-N S	GEC	786	786A	40	15	5.0	1.00W	125J	300.000G	50NA	15V	60	0.10A	
10B552-2	-N S	GEC	786	786A	40	15	5.0	1.00W	125J	200.000G	500NA	15V	60	0.10A	
10B553-3	-N S	GEC	786	786A	40	15	5.0	1.00W	125J	200.000G	500NA	15V	60	0.10A	
10B555-2	-N S	GEC	785	785A	25	20R	3.0	1.00W	125J	200.000G	500NA	15V	40	0.10A	
10B555-3	-N S	GEC	786	786A	25	20R	3.0	1.00W	125J	200.000G	500NA	15V	40	0.10A	
10B556-2	-N S	GEC	785	785A	25	15	5.0	1.00W	125J	200.000G	500NA	15V	36	0.10A	
10B556-3	-N S	GEC	786	786A	25	15	5.0	1.00W	125J	200.000G	500NA	15V	36	0.10A	
10C573-2	-N S	GEC	785	785A	45	45		1.00W	125J	200.000G	200NA	30V	62	0.01A	
10C573-3	-N S	GEC	786	786A	45	45		1.00W	125J	200.000G	200NA	30V	62	0.01A	
10C574-2	-N S	GEC	785	785A	45	45		1.00W	125J	200.000G	200NA	30V	160	0.01A	
10C574-3	-N S	GEC	786	786A	45	45		1.00W	125J	200.000G	200NA	30V	160	0.01A	
11B551-2	-N S	GEC	785	785A	60	28	5.0	1.00W	125J	40.000G	500NA	30V	36	0.10A	
11B551-3	-N S	GEC	786	786A	60	28	5.0	1.00W	125J	40.000G	500NA	30V	36	0.10A	
11B552-2	-N S	GEC	785	785A	60	28	5.0	1.00W	125J	50.000G	500NA	30V	70	0.10A	
11B552-3	-N S	GEC	786	786A	60	28	5.0	1.00W	125J	50.000G	500NA	30V	70	0.10A	
11B554-2	-N S	GEC	785	785A	60	28	7.0	1.00W	125J	60.000G	25NA	40V	70	0.10A	
11B554-3	-N S	GEC	786	786A	60	28	7.0	1.00W	125J	60.000G	25NA	40V	70	0.10A	
11B555-2	-N S	GEC	785	785A	60	28	7.0	1.00W	125J	60.000G	25NA	40V	176	0.10A	
11B555-3	-N S	GEC	786	786A	60	28	7.0	1.00W	125J	60.000G	25NA	40V	176	0.10A	
11B556-2	-N S	GEC	785	785A	100	80	7.0	1.00W	125J	50.000G	25NA	40V	70	0.10A	
11B556-3	-N S	GEC	786	786A	100	80	7.0	1.00W	125J	50.000G	25NA	40V	70	0.10A	
11B560-2	-N S	GEC	785	785A	100	60	5.0	1.00W	125J	50.000G	500NA	30V	70	0.10A	
11B560-3	-N S	GEC	786	786A	100	60	5.0	1.00W	125J	50.000G	500NA	30V	70	0.10A	
11C1B1	-N S	GEC	635	635B	40	5.0		1.000A	5.000W	200J	50.000G	10NA	30V	176	150A
11C1F1	-N S	GEC	530	530B	60	40	5.0	1.000A	5.000W	200J	50.000G	10NA	30V	176	150A
11C3B1	-N S	GEC	635	635B	80	50	8.0	1.000A	5.000W	200J	50.000G	10NA	60V	70	150A
11C3F1	-N S	GEC	530	530B	80	50	7.0	1.000A	3.100W	200J	50.000G	10NA	60V	70	150A
11C5B1	-N S	GEC	635	635B	60	40	5.0	1.000A	5.000W	200J	50.000G	10NA	30V	36	150A
11C5F1	-N S	GEC	530	530B	60	40	5.0	1.000A	3.100W	200J	50.000G	10NA	30V	36	150A
11C7B1	-N S	GEC	635	635B	45	25	5.0	1.000A	5.000W	200J	50.000G	10NA	30V	40	150A
11C7F1	-N S	GEC	530	530B	45	25	5.0	1.000A	3.100W	200J	50.000G	10NA	30V	40	150A
11C10B1	-N S	GEC	635	635B	120	80	7.0	1.000A	5.000W	200J	50.000G	10NA	60V	70	150A
11C10F1	-N S	GEC	530	530B	120	80	7.0	1.000A	3.100W	200J	50.000G	10NA	60V	70	150A
11C11B1	-N S	GEC	211	To 46	60	40	5.0	1.000A	5.000W	200A	50.000G	10NA	30V	80	
11C11B20	-N S	GEC	211	To 46	60	40	5.0	1.000A	5.000W	200A	50.000G	10NA	30V	80	
11C11F1	-N S	GEC	530	530B	60	40	5.0	1.000A	3.100W	200J	50.000G	10NA	30V	70	150A
11C201B20	-N S	GEC	612	612A	60	40	5.0	1.000A	5.000W	200J	50.000G	10NA	30V	176	150A
11C201B20	-N S	GEC	612	612A	60	40	5.0	1.000A	5.000W	200J	50.000G	10NA	60V	70	150A
11C205B20	-N S	G													

Transistor Type No.	M / P / S	Manufacturer	Lead Ident	Out- line	Maximum (V)			Maximum		Max. T.(°C)	Frequency Resp.(MHz)	Leakage		Gain	
					V _{CE}	V _{ES}	V _{ES}	I _C	Power			I _{ES} @ V _{CE}	I _{ES} @ V _{CE}	h _{FE}	h _{FE}
16G2		SEE 2N3663													
16J1		SEE 2N3605													
16J2		SEE 2N3606													
16J3		SEE 2N3607													
16K1	-N S	GEC	45	TO 98	30	30	4.0	.025A	.200W	100J	315.000G	500NA	20V	60	.005A
16K2	-N S	GEC	45	TO 98	30	30	4.0	.025A	.200W	100J	315.000G	500NA	20V	60	.005A
16K3	-N S	GEC	45	TO 98	30	30	4.0	.025A	.200W	100J	315.000G	500NA	20V	60	.005A
16L2	-N S	GEC	45	TO 98	30	30	4.0	.100A	.200W	100J	86.000G	500NA	18V	30	
16L3	-N S	GEC	45	TO 98	30	30	4.0	.100A	.200W	100J	86.000G	500NA	18V	54	
16L4	-N S	GEC	45	TO 98	30	30	4.0	.100A	.200W	100J	112.000G	500NA	18V	90	
16L5	-N S	GEC	45	TO 98	30	30	4.0	.100A	.200W	100J	412.400G	500NA	18V	10	
16L22	-N S	GEC	45	TO 98	30	30	4.0	.100A	.200W	100J	80.000G	500NA	18V	30	
16L23	-N S	GEC	45	TO 98	30	30	4.0	.100A	.200W	100J	86.000G	500NA	18V	54	
16L24	-N S	GEC	45	TO 98	30	30	4.0	.100A	.200W	100J	112.000G	500NA	18V	90	
16L25	-N S	GEC	45	TO 98	30	30	4.0	.100A	.200W	100J	124.000G	500NA	18V	104	
16L42	-N S	GEC	45	TO 98	18	18	4.0	.100A	.200W	100J	80.000G	500NA	18V	30	
16L43		SEE 2N3854													
16L44		SEE 2N3855													
16L45		SEE 2N3856													
16L62	-N S	GEC	45	TO 98	30	30	4.0	.100A	.200W	100J	80.000G	500NA	18V	30	
16L63		SEE 2N3854A													
16L64		SEE 2N3855A													
16L65		SEE 2N3856A													
16K1		SEE 2N3877A													
16K2		SEE 2N3877													
7172	N S	SES	635	635B	80		5.0		15.000W	175J	30.000G	50UA	60V	52	1.000A
7272	N S	SES	635	635B	80		5.0		15.000W	175J	30.000G	50UA	60V	125	1.000A
7372	N S	SES	635	635B	80		5.0		15.000W	175J	15.000G	75UA	80V	52	.200A
7472	N S	SES	635	635B	80		5.0		15.000W	175J	15.000G	75UA	80V	125	.200A
8072	N S	SES	171	TO 8	50		4.0		2.000W	175J	150.000G	100NA	30V	14	.046A
8172	N S	SES	211	TO 5	50		4.0		1.000W	175J	150.000G	100NA	30V	14	.040A
8272	N S	SES	545	TO 60		50R	4.0	1.000A	9.000W	175J	250.000G	1UA	30V	15	5.00A
8272	N S	SES	545	TO 60		60R	4.0	2.000A	10.000W	175J	250.000G	3UA	30V	15	1.000A
9072	N S	SES	43	TO 98	100		4.0	.050A	.200W	100J		500NA	70V	30	.030A
9176	N S	SES	45	TO 98	18		5.0	.100A	.200W	125J	5.000G	100NA	18V	375	.001A
9276	N S	SES	45	TO 98	18		5.0	.100A	.200W	125J	5.000G	100NA	18V	225	.001A
9376	N S	SES	45	TO 98	18		5.0	.100A	.200W	125J	5.000G	100NA	18V	150	.001A
9872	N S	SES	43	TO 98	18	18	5.0	.200A	.200W	100J	200.000G	500NA	18V	350	.100A
10072	N S	SES	605	TO 3	120	80S			85.000W		30.000G	10MA	120V	50	2.000A
10872	N S	SES	605	TO 3	120	80	10.0	30.000A	175.000W	200J	10.000G	500UA	120V	35	10.000A
10972	N S	SES	605	TO 3	160	125	10.0	30.000A	175.000W	200J	10.000G	500UA	120V	35	10.000A
11172	N S	SES	210	TO 5			90S	4.0	.800W	175J		1UA	30V	60	.150A
121-2		SEE 2N216													
121-7		SEE 2N35													
121-9		SEE 2N112													
121-10		SEE 2N111													
121-11		SEE CK725													
121-12		SEE CK725													
121-14		SEE 2N112													
121-21		SEE 2N193													
121-22		SEE 2N194													
121-24		SEE 2N168A													
121-25		SEE 2N168A													
121-26		SEE 2N168													
121-27		SEE 2N190													
121-33		SEE 2N169A													
121-34		SEE 2N186A													
121-44		SEE 2N370													
121-45		SEE 2N139													
121-46		SEE 2N109													
121-47		SEE 2N270													
121-48		SEE 2N371													
121-49		SEE 2N372													
121-50		SEE 2N253													
121-51		SEE 2N254													
121-54		SEE 2N252													
121-60		SEE 2N213													
121-61		SEE 2N407													
121-62		SEE 2N411													
121-63		SEE 2N247													
121-64		SEE 2N407													
121-65		SEE 2N409													
121-66		SEE 2N409													
121-67		SEE 2N308													
121-70		SEE 2N515													
121-71		SEE 2N516													
121-73		SEE 2N409													
121-74		SEE 2N409													
121-75		SEE 2N139													
121-76		SEE 2N139													
121-78		SEE 2N544													
121-91		SEE 2N483													
121-92		SEE 2N485													
121-93		SEE 2N483													
121-94		SEE 2N482													
121-95		SEE 2N632													
121-96		SEE 2N632													
121-101		SEE 2N544													
121-102		SEE 2N409													
121-103		SEE 2N411													
121-104		SEE 2N409													
121-105		SEE 2N409													
121-107		SEE 2N407													
121-113		SEE 2N309													
121-128		SEE 2N1108													
121-134		SEE 2N1177													
121-135		SEE 2N1178													
121-136		SEE 2N1179													
121-138		SEE 2N1180													
121-139		SEE 2N1180													
121-145		SEE 2N1108													
121-146		SEE 2N1110													
121-147		SEE 2N1111													
121-148		SEE 2N407													
121-150		SEE 2N1631													
121-153		SEE 2N1108													
121-154		SEE 2N1110													
121-161		SEE 2N410													
121-162		SEE 2N410													
121-164		SEE 2N408													

Transistor Type No.	N P S	G S	Manufacturer	Lead Ident	Out- line	Maximum (V)			Maximum		Max. T.(°C)	Frequency Resp.(MHz)	Leakage $I_{sat} @ V_{ce}$	Gain $h_{FE} @ I_c$
						V_{ce}	V_{ce}	V_{ce}	I_c	Power				
121-179			SEE 2N1527											
121-180			SEE 2N1525											
121-181			SEE 2N1525											
121-184			SEE 2N1374											
121-185			SEE 2N1525											
121-205			SEE 2N1374											
121-225			SEE 2N407											
121-228			SEE 2N1742											
121-229			SEE 2N1745											
121-230			SEE 2N1745											
121-231			SEE 2N1865											
121-232			SEE 2N1865											
121-233			SEE 2N1747											
121-240			SEE 2N2614											
121-241			SEE 2N218											
121-242			SEE 2N993											
121-243			SEE 2N993											
121-244			SEE 2N993											
121-256			SEE 2N1632											
121-257			SEE 2N1526											
121-258			SEE 2N1524											
121-259			SEE 2N1524											
121-260			SEE 2N1524											
121-266			SEE 2N406											
121-267			SEE 2N408											
121-268			SEE 2N1742											
121-269			SEE 2N1745											
121-294			SEE 2N2654											
121-295			SEE 2N2654											
121-296			SEE 2N2654											
121-297			SEE 2N2671											
121-298			SEE 2N2671											
121-299			SEE 2N2671											
121-300			SEE 2N2429											
121-301			SEE 2N2428											
121-302			SEE 2N1302											
121-305			SEE 2N2429											
121-310			SEE 2N2428											
121-311			SEE 2N2706											
151-04	N	S	WHE	412	TO 82	65	40	25.0	6.000A	100.000W	150J	.500G	10MA 40V	16 1.500A
151-06	N	S	WHE	412	TO 82	85	60	25.0	6.000A	100.000W	150J	.500G	10MA 60V	16 1.500A
151-08	N	S	WHE	412	TO 82	105	80	25.0	6.000A	100.000W	150J	.500G	10MA 80V	16 1.500A
151-10	N	S	WHE	412	TO 82	125	100	25.0	6.000A	100.000W	150J	.500G	10MA 100V	16 1.500A
151-12	N	S	WHE	412	TO 82	145	120	25.0	6.000A	100.000W	150J	.500G	10MA 120V	16 1.500A
151-14	N	S	WHE	412	TO 82	165	140	25.0	6.000A	100.000W	150J	.500G	10MA 140V	16 1.500A
151-16	N	S	WHE	412	TO 82	185	160	25.0	6.000A	100.000W	150J	.500G	10MA 160V	16 1.500A
151-18	N	S	WHE	412	TO 82	205	180	25.0	6.000A	100.000W	150J	.500G	10MA 180V	16 1.500A
151-20	N	S	WHE	412	TO 82	225	200	25.0	6.000A	100.000W	150J	.500G	10MA 200V	16 1.500A
151-22	N	S	WHE	412	TO 82	245	220	25.0	6.000A	100.000W	150J	.500G	10MA 220V	16 1.500A
151-24	N	S	WHE	412	TO 82	265	240	25.0	6.000A	100.000W	150J	.500G	10MA 240V	16 1.500A
151-26	N	S	WHE	412	TO 82	285	260	25.0	6.000A	100.000W	150J	.500G	10MA 260V	16 1.500A
151-28	N	S	WHE	412	TO 82	305	280	25.0	6.000A	100.000W	150J	.500G	10MA 280V	16 1.500A
151-30	N	S	WHE	412	TO 82	325	300	25.0	6.000A	100.000W	150J	.500G	10MA 300V	16 1.500A
152-04	N	S	WHE	412	TO 82	65	40	25.0	6.000A	100.000W	150J	.500G	10MA 40V	27 1.500A
152-06	N	S	WHE	412	TO 82	85	60	25.0	6.000A	100.000W	150J	.500G	10MA 60V	27 1.500A
152-08	N	S	WHE	412	TO 82	105	80	25.0	6.000A	100.000W	150J	.500G	10MA 80V	27 1.500A
152-10	N	S	WHE	412	TO 82	125	100	25.0	6.000A	100.000W	150J	.500G	10MA 100V	27 1.500A
152-12	N	S	WHE	412	TO 82	145	120	25.0	6.000A	100.000W	150J	.500G	10MA 120V	27 1.500A
152-14	N	S	WHE	412	TO 82	165	140	25.0	6.000A	100.000W	150J	.500G	10MA 140V	27 1.500A
152-16	N	S	WHE	412	TO 82	185	160	25.0	6.000A	100.000W	150J	.500G	10MA 160V	27 1.500A
152-18	N	S	WHE	412	TO 82	205	180	25.0	6.000A	100.000W	150J	.500G	10MA 180V	27 1.500A
152-20	N	S	WHE	412	TO 82	225	200	25.0	6.000A	100.000W	150J	.500G	10MA 200V	27 1.500A
152-22	N	S	WHE	412	TO 82	245	220	25.0	6.000A	100.000W	150J	.500G	10MA 220V	27 1.500A
152-24	N	S	WHE	412	TO 82	265	240	25.0	6.000A	100.000W	150J	.500G	10MA 240V	27 1.500A
152-26	N	S	WHE	412	TO 82	285	260	25.0	6.000A	100.000W	150J	.500G	10MA 260V	27 1.500A
152-28	N	S	WHE	412	TO 82	305	280	25.0	6.000A	100.000W	150J	.500G	10MA 280V	27 1.500A
152-30	N	S	WHE	412	TO 82	325	300	25.0	6.000A	100.000W	150J	.500G	10MA 300V	27 1.500A
153-04	N	S	WHE	560	560A	65	40	15.0	7.500A	200.000W	175J	.500G	10MA 40V	23 1.500A
153-06	N	S	WHE	560	560A	85	60	15.0	7.500A	200.000W	175J	.500G	10MA 60V	23 1.500A
153-08	N	S	WHE	560	560A	105	80	15.0	7.500A	200.000W	175J	.500G	10MA 80V	23 1.500A
153-10	N	S	WHE	560	560A	125	100	15.0	7.500A	200.000W	175J	.500G	10MA 100V	23 1.500A
153-12	N	S	WHE	560	560A	145	120	15.0	7.500A	200.000W	175J	.500G	10MA 120V	23 1.500A
153-14	N	S	WHE	560	560A	165	140	15.0	7.500A	200.000W	175J	.500G	10MA 140V	23 1.500A
153-16	N	S	WHE	560	560A	185	160	15.0	7.500A	200.000W	175J	.500G	10MA 160V	23 1.500A
153-18	N	S	WHE	560	560A	205	180	15.0	7.500A	200.000W	175J	.500G	10MA 180V	23 1.500A
153-20	N	S	WHE	560	560A	225	200	15.0	7.500A	200.000W	175J	.500G	10MA 200V	23 1.500A
153-22	N	S	WHE	560	560A	245	220	15.0	7.500A	200.000W	175J	.500G	10MA 220V	23 1.500A
153-24	N	S	WHE	560	560A	265	240	15.0	7.500A	200.000W	175J	.500G	10MA 240V	23 1.500A
153-26	N	S	WHE	560	560A	285	260	15.0	7.500A	200.000W	175J	.500G	10MA 260V	23 1.500A
153-28	N	S	WHE	560	560A	305	280	15.0	7.500A	200.000W	175J	.500G	10MA 280V	23 1.500A
153-30	N	S	WHE	560	560A	325	300	15.0	7.500A	200.000W	175J	.500G	10MA 300V	23 1.500A
154-04	N	S	WHE	560	560A	65	40	15.0	7.500A	200.000W	175J	.500G	10MA 40V	38 1.500A
154-06	N	S	WHE	560	560A	85	60	15.0	7.500A	200.000W	175J	.500G	10MA 60V	38 1.500A
154-08	N	S	WHE	560	560A	105	80	15.0	7.500A	200.000W	175J	.500G	10MA 80V	38 1.500A
154-10	N	S	WHE	560	560A	125	100	15.0	7.500A	200.000W	175J	.500G	10MA 100V	38 1.500A
154-12	N	S	WHE	560	560A	145	120	15.0	7.500A	200.000W	175J	.500G	10MA 120V	38 1.500A
154-14	N	S	WHE	560	560A	165	140	15.0	7.500A	200.000W	175J	.500G	10MA 140V	38 1.500A
154-16	N	S	WHE	560	560A	185	160	15.0	7.500A	200.000W	175J	.500G	10MA 160V	38 1.500A
154-18	N	S	WHE	560	560A	205	180	15.0	7.500A	200.000W	175J	.500G	10MA 180V	38 1.500A
154-20	N	S	WHE	560	560A	225	200	15.0	7.500A	200.000W	175J	.500G	10MA 200V	38 1.500A
154-22	N	S	WHE	560	560A	245	220	15.0	7.500A	200.000W	175J	.500G	10MA 220V	38 1.500A
154-24	N	S	WHE	560	560A	265	240	15.0	7.500A	200.000W	175J	.500G	10MA 240V	38 1.500A
154-26	N	S	WHE	560	560A	285	260	15.0	7.500A	200.000W	175J	.500G	10MA 260V	38 1.500A
154-28	N	S	WHE	560	560A	305	280	15.0	7.500A	200.000W	175J	.500G	10MA 280V	38 1.500A
154-30	N	S	WHE	560	560A	325	300	15.0	7.500A	200.000W	175J	.500G	10MA 300V	38 1.500A
156-043	N	S	WHE	605	TO 3	40	7.0	15.000A	115.000W	200J	1.000G		30 4.000A	
156-044	N	S	WHE	605	TO 3	40	7.0	15.000A	115.000W	200J	1.000G		30 4.000A	
156-083	N	S	WHE	605	TO 3	80	7.0	15.000A	115.000W	200J	1.000G		27 3.000A	
156-084	N	S	WHE	605	TO 3	80	7.0	15.000A	115.000W	200J	1.000G		30 4.000A	
156-104	N	S	WHE	605	TO 3	100	7.0	15.000A	115.000W	200J	1.000G		30 4.000A	
156-123	N	S	WHE	605	TO 3	120	7.0	15.000A	115.000W	200J	1.000G		27 3.000A	
156-124	N	S	WHE	605	TO 3	120	7.0	15.00						

Transistor Type No.	N P S	Manufacturer	Lead Ident	Out- line	Maximum (V)			Maximum		Max. T _c (°C)	Frequency Resp.(MHz)	Leakage I _z @ V _z	Gain h _{FE} @ I _c
					V _{CE}	V _{BE}	V _{ES}	I _c	Power				
163-14	N S	WHE	561	561F	155	140	15.0	20.000A	200.000W	175J	.500G	10MA 140V	23 5.000A
163-16	N S	WHE	561	561F	175	160	15.0	20.000A	200.000W	175J	.500G	10MA 160V	23 5.000A
163-18	N S	WHE	561	561F	195	180	15.0	20.000A	200.000W	175J	.500G	10MA 180V	23 5.000A
163-20	N S	WHE	561	561F	215	200	15.0	20.000A	200.000W	175J	.500G	10MA 200V	23 5.000A
163-22	N S	WHE	561	561F	235	220	15.0	20.000A	200.000W	175J	.500G	30MA 240V	23 5.000A
163-24	N S	WHE	561	561F	255	240	15.0	20.000A	200.000W	175J	.500G	30MA 260V	23 5.000A
163-26	N S	WHE	561	561F	275	260	15.0	20.000A	200.000W	175J	.500G	30MA 280V	23 5.000A
163-28	N S	WHE	561	561F	295	280	15.0	20.000A	200.000W	175J	.500G	30MA 300V	23 5.000A
163-30	N S	WHE	561	561F	315	300	15.0	20.000A	200.000W	175J	.500G	30MA 40V	38 5.000A
164-04	N S	WHE	561	561F	55	40	15.0	20.000A	200.000W	175J	.500G	30MA 60V	38 5.000A
164-06	N S	WHE	561	561F	95	80	15.0	20.000A	200.000W	175J	.500G	30MA 80V	38 5.000A
164-08	N S	WHE	561	561F	115	100	15.0	20.000A	200.000W	175J	.500G	30MA 100V	38 5.000A
164-10	N S	WHE	561	561F	135	120	15.0	20.000A	200.000W	175J	.500G	30MA 120V	38 5.000A
164-12	N S	WHE	561	561F	155	140	15.0	20.000A	200.000W	175J	.500G	30MA 140V	38 5.000A
164-14	N S	WHE	561	561F	175	160	15.0	20.000A	200.000W	175J	.500G	30MA 160V	38 5.000A
164-16	N S	WHE	561	561F	195	180	15.0	20.000A	200.000W	175J	.500G	30MA 180V	38 5.000A
164-18	N S	WHE	561	561F	215	200	15.0	20.000A	200.000W	175J	.500G	30MA 200V	38 5.000A
164-20	N S	WHE	561	561F	235	220	15.0	20.000A	200.000W	175J	.500G	30MA 220V	37 5.000A
164-22	N S	WHE	561	561F	255	240	15.0	20.000A	200.000W	175J	.500G	30MA 240V	37 5.000A
164-24	N S	WHE	561	561F	275	260	15.0	20.000A	200.000W	175J	.500G	30MA 260V	37 5.000A
164-26	N S	WHE	561	561F	295	280	15.0	20.000A	200.000W	175J	.500G	30MA 280V	37 5.000A
164-28	N S	WHE	561	561F	315	300	15.0	20.000A	200.000W	175J	.500G	30MA 300V	37 5.000A
164-30	N S	WHE	561	561F	335	320	15.0	20.000A	200.000W	175J	.500G		
176-04	-N	WHE	561	TO 63	47	40	7.5	20.000A	200.000W	200J	.030G		30 20.000A
176-06	-N	WHE	561	TO 63	67	60	7.5	20.000A	200.000W	200J	.030G		30 20.000A
176-08	-N	WHE	561	TO 63	87	80	7.5	20.000A	200.000W	200J	.030G		30 20.000A
176-10	-N	WHE	561	TO 63	107	100	7.5	20.000A	200.000W	200J	.030G		30 20.000A
176-12	-N	WHE	561	TO 63	127	120	7.5	20.000A	200.000W	200J	.030G		30 20.000A
176-14	-N	WHE	561	TO 63	147	140	7.5	20.000A	200.000W	200J	.030G		30 20.000A
176-16	-N	WHE	561	TO 63	167	160	7.5	20.000A	200.000W	200J	.030G		30 20.000A
18072	N S	SES	605	TO 3	60	60	10.0	6.000A	85.000W	200J	10.000G	10MA 60V	60 2.000A
18172	N S	SES	605	TO 3	100	90	10.0	6.000A	85.000W	200J	10.000G	1MA 100V	60 2.000A
18272	N S	SES	605	TO 3	200	140	10.0	6.000A	85.000W	200J	10.000G	1MA 250V	60 2.000A
18372	N S	SES	605	TO 3	400	200	10.0	6.000A	85.000W	200J	10.000G	1MA 300V	60 2.000A
18472	N S	SES	605	TO 3	500	250	10.0	6.000A	85.000W	200J	10.000G	1MA 400V	60 2.000A
18572	N S	SES	605	TO 3	500	250	10.0	6.000A	85.000W	200J	10.000G		
903		SEE											
904		SEE											
904A		SEE											
905		SEE											
910		SEE											
951		SEE											
952		SEE											
952		SEE											
1401-12	-N S	WHE	508	TO 93	130	120	10.0	250.000A	625.000W	200J	1.000G		15 99.000A
1401-14	-N S	WHE	508	TO 93	150	140	10.0	250.000A	625.000W	200J	1.000G		15 99.000A
1401-0415	-N S	WHE	508	TO 93	40	40	10.0	250.000A	625.000W	200J	.500G		15 99.000A
1401-0420	-N S	WHE	508	TO 93	50	40	10.0	250.000A	625.000W	200J	.500G		15 99.000A
1401-0425	-N S	WHE	508	TO 93	60	40	10.0	250.000A	625.000W	200J	.500G		15 99.000A
1401-0415	-N S	WHE	508	TO 93	60	10.0	250.000A	625.000W	200J	.500G		15 99.000A	
1401-0620	-N S	WHE	508	TO 93	70	60	10.0	250.000A	625.000W	200J	.500G		15 99.000A
1401-0625	-N S	WHE	508	TO 93	80	10.0	250.000A	625.000W	200J	.500G		15 99.000A	
1401-0815	-N S	WHE	508	TO 93	80	10.0	250.000A	625.000W	200J	.500G		15 99.000A	
1401-0820	-N S	WHE	508	TO 93	80	10.0	250.000A	625.000W	200J	.500G		15 99.000A	
1401-0825	-N S	WHE	508	TO 93	90	80	10.0	250.000A	625.000W	200J	.500G		15 99.000A
1401-1015	-N S	WHE	508	TO 93	100	100	10.0	250.000A	625.000W	200J	.500G		15 99.000A
1401-1020	-N S	WHE	508	TO 93	100	100	10.0	250.000A	625.000W	200J	.500G		15 99.000A
1401-1025	-N S	WHE	508	TO 93	110	100	10.0	250.000A	625.000W	200J	.500G		15 99.000A
1401-1215	-N S	WHE	508	TO 93	120	100	10.0	250.000A	625.000W	200J	.500G		15 99.000A
1441-0405	-N S	WHE	563	TO 114	40	40	10.0	150.000A	350.000W	200J	.500G		15 99.000A
1441-0407	-N S	WHE	563	TO 114	40	40	10.0	150.000A	350.000W	200J	.500G		15 99.000A
1441-0410	-N S	WHE	563	TO 114	40	40	10.0	150.000A	350.000W	200J	.500G		15 99.000A
1441-0605	-N S	WHE	563	TO 114	60	10.0	150.000A	350.000W	200J	.500G		15 99.000A	
1441-0607	-N S	WHE	563	TO 114	60	10.0	150.000A	350.000W	200J	.500G		15 99.000A	
1441-0610	-N S	WHE	563	TO 114	60	10.0	150.000A	350.000W	200J	.500G		15 99.000A	
1441-0805	-N S	WHE	563	TO 114	80	10.0	150.000A	350.000W	200J	.500G		15 99.000A	
1441-0807	-N S	WHE	563	TO 114	80	10.0	150.000A	350.000W	200J	.500G		15 99.000A	
1441-0810	-N S	WHE	563	TO 114	80	10.0	150.000A	350.000W	200J	.500G		15 99.000A	
1441-1005	-N S	WHE	563	TO 114	100	100	10.0	150.000A	350.000W	200J	.500G		15 99.000A
1441-1007	-N S	WHE	563	TO 114	100	100	10.0	150.000A	350.000W	200J	.500G		15 99.000A
1441-1010	-N S	WHE	563	TO 114	100	100	10.0	150.000A	350.000W	200J	.500G		15 99.000A
1441-1205	-N S	WHE	563	TO 114	120	100	10.0	150.000A	350.000W	200J	.500G		15 99.000A
1441-1207	-N S	WHE	563	TO 114	120	100	10.0	150.000A	350.000W	200J	.500G		15 99.000A
1441-1210	-N S	WHE	563	TO 114	120	100	10.0	150.000A	350.000W	200J	.500G		15 99.000A
1571-0420	-N S	WHE	605	TO 66	40	7.0	4.000A	29.000W	200J	1.000G		38 4.000A	
1571-0425	-N S	WHE	605	TO 66	40	7.0	4.000A	29.000W	200J	1.000G		30 3.000A	
1571-0620	-N S	WHE	605	TO 66	60	7.0	4.000A	29.000W	200J	1.000G		30 3.000A	
1571-0820	-N S	WHE	605	TO 66	80	7.0	4.000A	29.000W	200J	1.000G		30 3.000A	
1571-0825	-N S	WHE	605	TO 66	80	7.0	4.000A	29.000W	200J	1.000G		30 3.000A	
1571-1020	-N S	WHE	605	TO 66	100	7.0	4.000A	29.000W	200J	1.000G		38 4.000A	
1571-1025	-N S	WHE	605	TO 66	120	7.0	4.000A	29.000W	200J	1.000G		30 3.000A	
1571-1220	-N S	WHE	605	TO 66	120	7.0	4.000A	29.000W	200J	1.000G		38 4.000A	
1571-1225	-N S	WHE	605	TO 66	120	7.0	4.000A	29.000W	200J	1.000G		30 3.000A	
1571-1425	-N S	WHE	605	TO 66	140	7.0	4.000A	29.000W	200J	1.000G		38 4.000A	
1571-1620	-N S	WHE	605	TO 66	160	7.0	4.000A	29.000W	200J	1.000G		30 3.000A	
1571-1625	-N S	WHE	605	TO 66	160	7.0	4.000A	29.000W	200J	1.000G		38 4.000A	
1582-0508	-N S	WHE	605	TO 3	40	7.0	30.000A	150.000W	200J	1.000G		23 8.000A	
1582-0510	-N S	WHE	605	TO 3	50	7.0	30.000A	150.000W	200J	1.000G		23 10.000A	
1582-0608	-N S	WHE	605	TO 3	60	7.0	30.000A	150.000W	200J	1.000G		23 8.000A	
1582-0615	-N S	WHE	605	TO 3	80	7.0	30.000A	150.000W	200J	1.000G		23 15.000A	
1582-0808	-N S	WHE	605	TO 3	80	7.0	30.000A	150.000W	200J	1.000G		23 8.000A	
1582-0815	-N S	WHE	605	TO 3	80	7.0	30.000A	150.000W	200J	1.000G		23 15.000A	
1582-1008	-N S	WHE	605	TO 3	100	7.0	30.000A	150.000W	200J	1.000G		23 8.000A	
1582-1010	-N S	WHE	605	TO 3	100	7.0	30.000A	150.000W	200J	1.000G		23 10.000A	
1582-1015													

Transistor Type No.	N P S	G S	Manufacturer	Lead Ident	Out- line	Maximum (V)			Maximum		Max. T.(°C)	Frequency Resp.(MHz)	Leakage			Gain $\beta_{V_{CE}}$ @ I_C
						V_{CE}	V_{CE}	V_{BE}	I_C	Power			I_{B1}	I_{B2}	I_{B3}	
1776-1460	N	S	WHE	560	TO 63	140	7.0		75.000A	150.000W	200J	35.000G			23	60.000A
1776-1640	N	S	WHE	560	TO 63	160	7.0		75.000A	150.000W	200J	35.000G			23	40.000A
3907	P	G	SEE 2N404A													
40022	P	G	RCA	605	TO 3	32	32R	5.0	5.000A	12.500W	100J	.300G	1MA	30V	70	1.000A
40050	P	G	RCA	605	TO 3	40	40	5.0	5.000A	12.500W	100J	.500G	500UA	30V	90	
40051	P	G	RCA	605	TO 3	50	50R	5.0	5.000A	12.500W	100J	.500G	500UA	30V	90	
40053	N	S	SEE 2N3053													
40080	N	S	RCA	211	TO 5	30			.250A	.500W	200J	CBAMP	10UA	15V		
40081	N	S	RCA	211	TO 5	60X	2.0		.250A	2.000W	200J	CBAMP	10UA	15V		
40082	N	S	SEE RF POWER SECTION													
40084	N	S	RCA	211	TO 18	60	40	5.0	1.000A	1.800W	200J	100.000G	250NA	30V	112	.150A
40217	N	S	SEE 2N3261													
40218	N	S	SEE 2N3261													
40219	N	S	SEE 2N3261													
40220	N	S	SEE 2N3261													
40221	N	S	SEE 2N3261													
40222	N	S	SEE 2N3261													
40231	N	S	RCA	170	170J	18	18	5.0	.100A	.500W	175J	60.000G	10UA	12V	80	.002A
40232	N	S	RCA	170	170J	18	18	5.0	.100A	.500W	175J	60.000G	10UA	12V	75	.002A
40233	N	S	RCA	170	170J	18	18	5.0	.100A	.500W	175J	60.000G	10UA	12V	80	.002A
40234	N	S	RCA	170	170J	18	18	5.0	.100A	.500W	175J	60.000G	10UA	12V	80	.002A
40235	N	S	RCA	217	TO104	35	3.0		.050A	.180W	175J	1200.000G	1UA	35V	80	.001A
40236	N	S	RCA	217	TO104	35	3.0		.050A	.180W	175J	1200.000G	1UA	35V	80	.001A
40237	N	S	RCA	217	TO104	35	3.0		.050A	.180W	175J	1200.000G	1UA	35V	80	.001A
40238	N	S	RCA	217	TO104	35	3.0		.050A	.180W	175J	1200.000G	1UA	35V	80	.001A
40239	N	S	RCA	217	TO104	35	3.0		.050A	.180W	175J	1200.000G	1UA	35V	80	.001A
40240	N	S	RCA	217	TO104	35	3.0		.050A	.180W	175J	1200.000G	1UA	35V	80	.001A
40242	N	S	RCA	217	TO104	35	5.0		.050A	.180W	175J	400.000G	20NA	1V	80	.001A
40243	N	S	RCA	217	TO104	35	3.0		.050A	.180W	175J	400.000G	20NA	1V	80	.001A
40244	N	S	RCA	217	TO104	35	3.0		.050A	.180W	175J	400.000G	20NA	1V	65	.001A
40245	N	S	RCA	217	TO104	35	3.0		.050A	.180W	175J	400.000G	20NA	1V	20	.001A
40246	N	S	RCA	217	TO104	35	3.0		.050A	.180W	175J	400.000G	20NA	1V	55	.001A
40250	N	S	RCA	605	TO 66	50	40	5.0	4.000A	29.000W	200J	1.000G	1MA	30V	50	1.500A
40250V1	N	S	RCA	720	720A	40	5.0		4.000A	5.800W	200J	1.000G	1MA	30V	50	1.500A
40251	N	S	RCA	605	TO 3	50	40	5.0	15.000A	117.000W	200J	.500G	2MA	40V	30	8.000A
40253	N	S	RCA	120	TO 1	25	25	2.5	.500A	.125W	90J	1.000G	14UA	12V	76	.400A
40254	P	G	RCA	605	TO 3	32	32R	5.0	5.000A	12.500W	100J	.300G	3MA	30V	70	1.000A
40261	P	G	RCA	120	TO 1	50										
40262	P	G	RCA	120	TO 1	50										
40263	P	G	RCA	120	TO 1	20	18R	2.5		.080W	85J	40.000G	12UA	12V	80	
40264	N	S	RCA	622	622A	300	300X	3.0		4.000W	150J	25.000G	100UA	100V	70	
40268	N	S	RCA	211	TO 18	25	15S	1.0	.100A	.100W	100J	250.000G	10UA	12V	100	.001A
40269	N	S	RCA	211	TO 5	25	12.0		.100A	.150W	85J	4.000G	5UA	12V	100	.012A
40279	N	S	SEE RF POWER SECTION													
40280	N	S	SEE RF POWER SECTION													
40281	N	S	SEE RF POWER SECTION													
40282	N	S	SEE RF POWER SECTION													
40283	N	S	RCA	211	TO 46	60	30	5.0		400W	200J	250.000G	500NA	30V	10	.500A
40290	N	S	SEE RF POWER SECTION													
40291	N	S	SEE RF POWER SECTION													
40292	N	S	SEE RF POWER SECTION													
40294	N	S	RCA	217	TO 72	30	15	2.5	.040A	.200W	200J	1000.000G	10NA	15V	70	.003A
40295	N	S	RCA	217	TO 72	35	20	3.0	.040A	.200W	200J	700.000G	10NA	15V	80	.002A
40296	N	S	RCA	217	TO 72	30	15	2.5	.040A	.200W	200J	1000.000G	10NA	15V	68	.003A
40305	N	S	SEE RF POWER SECTION													
40306	N	S	SEE RF POWER SECTION													
40307	N	S	SEE RF POWER SECTION													
40309	N	S	RCA	210	TO 5	18	2.5		.700A	1.000W	200J	50.000G	250NA	15V	160	.050A
40310	N	S	RCA	605	TO 66	35	2.5		4.000A	29.000W	200J	.375G	10NA	15V	50	1.000A
40311	N	S	RCA	210	TO 5	30	2.5		.700A	1.000W	200J	50.000G	250NA	15V	160	.050A
40312	N	S	RCA	605	TO 66	50R	2.5		4.000A	29.000W	200J	3.75G	10NA	15V	50	1.000A
40313	N	S	RCA	605	TO 66	300R	2.5		2.000A	35.000W	200J	AUO	5MA	150V	100	.100A
40314	N	S	RCA	210	TO 5	40	2.5		.700A	1.000W	200J	50.000G	250NA	15V	160	.050A
40315	N	S	RCA	210	TO 5	35	2.5		.700A	1.000W	200J	50.000G	250NA	15V	160	.050A
40316	N	S	RCA	605	TO 66	40	5.0		4.000A	29.000W	200J	.375G	10UA	15V	50	1.000A
40317	N	S	RCA	605	TO 66	40	2.5		2.000A	35.000W	200J	100.000G	250NA	15V	90	.010A
40318	N	S	RCA	605	TO 66	300R	6.0		2.000A	35.000W	200J	AUO	5MA	150V	80	.020A
40319	N	S	RCA	210	TO 5	40	2.5		.700A	1.000W	200J	50.000G	250NA	15V	80	.050A
40320	N	S	RCA	210	TO 5	40	2.5		.700A	1.000W	200J	AUO	5MA	150V	90	.050A
40321	N	S	RCA	210	TO 5	300R	6.0		2.000A	35.000W	200J	AUO	100UA	150V	80	.020A
40322	N	S	RCA	605	TO 66	300R	6.0		2.000A	35.000W	200J	AUO	5MA	150V	80	.020A
40323	N	S	RCA	210	TO 5	18	2.5		.700A	1.000W	200J	50.000G	250NA	15V	160	.050A
40324	N	S	RCA	605	TO 66	35	2.5		4.000A	29.000W	200J	.375G	10UA	15V	50	1.000A
40325	N	S	RCA	605	TO 3	35	35	5.0	15.000A	117.000W	200J	AUO	250NA	15V	90	.010A
40326	N	S	RCA	210	TO 5	40	2.5		.700A	1.000W	200J	AUO	5MA	150V	80	.020A
40327	N	S	RCA	210	TO 5	300R	5.0		1.000A	1.000W	200J	AUO	100UA	150V	80	.010A
40328	N	S	RCA	605	TO 66	300R	6.0		2.000A	35.000W	200J	AUO	5UA	150V	40	1.000A
40329	N	S	RCA	120	TO 1	25	25R	2.5	.100A	.125W	100J	.750G	14UA	12V	90	.025A
40340	N	S	SEE RF POWER SECTION													
40341	N	S	SEE RF POWER SECTION													
40342	N	S	RCA	540	TO 60	65	65	4.0	3.000A	23.000W	200J		250NA	30V	20	.300A
40343	N	S	RCA	540	TO 60	65	65	4.0	3.000A	23.000W	200J		250NA	30V	20	.300A
40346	N	S	RCA	211	TO 5	200	175R		1.000A	1.000W	200J	10.000G	5UA	20V	50	.010A
40346V1	N	S														

Transistor Type No.	N P	G S	Manufacturer	Lead Ident	Out- line	Maximum (V)			Maximum		Max. T.(°C)	Frequency Resp.(MHz)	Leakage		Gain	
						V _{CE}	V _{BE}	V _{ES}	I _C	Power			I _{CEO}	V _{CE(sat)}	h _{FE}	h _{FE}
40375	N	S	RCA	720	720A	120	50	7.0	7.000A	5.800W	200J	4.000G	5MA	40V	100	.500A
40385	N	S	RCA	211	TO 5	450	350	7.0	1.000A	1.000W	200J	AUD	20UA	30V	80	.020A
40389	N	S	RCA	722	722A	300	40	5.0	1.000A	1.000W	200J	8.00G	250NA	30V	112	.150A
40390	N	S	RCA	722	722A	300	250	7.0	1.000A	3.500W	200J	8.666G	50UA	20V	80	.020A
40391	P	S	RCA	722	722A	60	40	7.0	1.000A	3.500W	200J	60.000G	250NA	60V	112	.150A
40392	P	S	RCA	635	635B	60	40	5.0	7.00A	7.00W	200J	.80G	635NA	30V	112	.150A
40394	P	S	RCA	635	635B	60	40	5.0	1.000A	7.00W	200J	60.000G	250NA	60V	112	.150A
40395	P	S	RCA	120	TO 1	20	18R	20.0	.050A	.120W	100J	10.000G	100NA	25V	246	.100A
40397	N	S	RCA	211	211L	25	7.5	2.0A	.400W	.175J	50.000G	100NA	25V	140	.100A	
40398	N	S	RCA	211	211L	18	7.0	2.0A	.400W	.175J	50.000G	500NA	12V	140	.100A	
40399	N	S	RCA	211	211L	18	7.0	2.0A	.400W	.175J	50.000G	500NA	12V	140	.100A	
40400	N	S	RCA	211	211L	18	7.0	2.0A	.400W	.175J	50.000G	500NA	12V	140	.100A	
40403	P	S	RCA	212	TO 5	30	20	2.0A	.200W	.85J	5.000B	6UA	20V	68	.010A	
40404	N	S	RCA	211	TO 52	40	16	5.0	.500A	.300W	175J	310.000G	25NA	20V	40	.050A
40405	N	S	RCA	211	TO 52	40	16	6.0	.500A	.300W	175J	300.000G	400NA	15V	40	.100A
40406	P	S	RCA	211	TO 5	50	4.0	7.0A	1.000W	200J	100.000G	10UA	40V	80	.010A	
40407	N	S	RCA	211	TO 5	50	4.0	7.0A	1.000W	200J	100.000G	10UA	40V	80	.010A	
40408	N	S	RCA	211	TO 5	90	4.0	7.0A	1.000W	200J	100.000G	10UA	80V	90	.010A	
40409	N	S	RCA	722	722A	90R	4.0	7.0A	3.000W	200J	100.000G	10UA	80V	112	.150A	
40410	N	S	RCA	605	TO 3	90R	4.0	30.000A	150.000W	200J	100.000G	10UA	80V	112	.150A	
40411	N	S	RCA	211	TO 5	250R	2.0	1.000A	1.000W	200J	10.000G	500UA	100V	60	4.000A	
40412	N	S	RCA	722	722A	250R	2.0	1.000A	4.000W	200J	10.000G	1MA	100V	80	.030A	
40412V1	N	S	RCA	211	TO 72	35	2.0	3.0	10.00A	5.000W	85J	100.000G	200UA	10V	35	.050A
40412V2	N	S	RCA	211	TO 72	35	2.0	3.0	10.00A	5.000W	85J	100.000G	200UA	10V	35	.050A
40413	N	S	RCA	217	TO 72	30	1.5	2.5	2.000A	2.000W	200J	700.000G	10UA	15V	80	.002A
40414	P	S	RCA	605	TO 3	75	5.0	5.000A	12.500W	100J	2.000G	1MA	40V	100	1.000A	
40421	N	S	RCA	605	TO 66	300	300X	2.0	1.50A	8.000W	150J	25.000G	100UA	30V	80	.050A
40422	N	S	RCA	720	720B	300	300X	2.0	1.50A	8.000W	150J	25.000G	100UA	30V	80	.050A
40423	N	S	RCA	605	TO 66	300	300X	2.0	1.50A	8.000W	150J	25.000G	100UA	30V	80	.050A
40424	N	S	RCA	605	TO 66	300	300X	2.0	1.50A	8.000W	150J	25.000G	100UA	30V	80	.050A
40425	N	S	RCA	720	720B	300	300X	2.0	1.50A	8.000W	150J	25.000G	100UA	30V	80	.050A
40426	N	S	RCA	605	TO 66	300	300X	2.0	1.50A	8.000W	150J	25.000G	100UA	30V	80	.050A
40427	P	S	RCA	720	720B	300	300X	2.0	1.50A	8.000W	150J	25.000G	100UA	30V	80	.050A
40439	P	G	RCA	605	TO 3	200	2.0	10.00A	5.000W	85J	HORAM	200UA	10V	20	.010A	
40440	N	S	RCA	605	TO 3	200	2.0	10.00A	5.000W	85J	HORAM	200UA	10V	20	.010A	
40444	N	S	RCA	605	TO 3	120	60	7.0	20.000A	140.000W	200J	60.000G	20MA	40V	68	2.000A
40446	N	S	RCA	211	211M	30	25	7.5	1.000W	1.000W	175J	175.000G	100NA	25V	150	.010A
40450	N	S	RCA	211	211M	40	40	8.0	.300A	1.000W	175J	50.000G	10NA	25V	200	.010A
40451	N	S	RCA	211	211M	40	40	8.0	2.00A	1.000W	175J	50.000G	100NA	25V	300	.010A
40452	N	S	RCA	211	211M	25	7.5	2.0A	1.000W	175J	50.000G	100NA	25V	300	.010A	
40453	N	S	RCA	211	211M	25	7.5	2.0A	1.000W	175J	50.000G	100NA	25V	300	.010A	
40454	N	S	RCA	211	211M	18	7.0	2.0A	1.000W	175J	50.000G	500NA	12V	300	.010A	
40455	N	S	RCA	211	211M	18	7.0	2.0A	1.000W	175J	50.000G	500NA	12V	300	.010A	
40456	N	S	RCA	211	211M	18	7.0	2.0A	1.000W	175J	50.000G	500NA	12V	300	.010A	
40458	N	S	RCA	211	211M	60	40	8.0	1.000A	5.000W	175J	150.000G	10NA	25V	150	.010A
40459	N	S	RCA	211	211M	60	40	8.0	1.000A	1.000W	175J	150.000G	10NA	25V	150	.010A
40462	P	S	RCA	605	TO 3	40	4.0	5.000A	12.500W	100J	.600G	500UA	30V	90	1.000A	
40464	N	S	RCA	605	TO 3	35	35	4.0	5.000A	40.000W	150J	2.000G	25UA	15V	60	.010A
40465	N	S	RCA	605	TO 3	40	4.0	4.0	5.000A	40.000W	150J	3.000G	100UA	40V	90	2.000A
40466	N	S	RCA	605	TO 3	50	50	4.0	5.000A	40.000W	150J	3.000G	100UA	50V	90	2.000A
40469	N	S	RCA	218	TO 104	45	3.0	.050A	.180W	.175J	800.000G	1UA	45V	80	.001A	
40470	N	S	RCA	218	TO 104	45	3.0	.050A	.180W	.175J	700.000G	1UA	45V	80	.001A	
40471	N	S	RCA	218	TO 104	45	3.0	.050A	.180W	.175J	700.000G	1UA	45V	80	.001A	
40472	N	S	RCA	218	TO 104	45	3.0	.050A	.180W	.175J	900.000G	1UA	45V	80	.001A	
40473	N	S	RCA	218	TO 104	45	3.0	.050A	.180W	.175J	900.000G	1UA	45V	100	.001A	
40474	N	S	RCA	218	TO 104	45	3.0	.050A	.180W	.175J	900.000G	1UA	45V	100	.001A	
40475	N	S	RCA	218	TO 104	45	3.0	.050A	.180W	.175J	900.000G	1UA	45V	96	.001A	
40476	N	S	RCA	218	TO 104	45	3.0	.050A	.180W	.175J	800.000G	1UA	45V	96	.001A	
40477	N	S	RCA	218	TO 104	45	3.0	.050A	.180W	.175J	800.000G	1UA	45V	96	.001A	
40478	N	S	RCA	218	TO 104	45	3.0	.050A	.180W	.175J	800.000G	1UA	45V	96	.001A	
40479	N	S	RCA	218	TO 104	45	3.0	.050A	.180W	.175J	800.000G	1UA	45V	96	.001A	
40480	N	S	RCA	218	TO 104	45	3.0	.050A	.180W	.175J	800.000G	1UA	45V	96	.001A	
40481	N	S	RCA	218	TO 104	45	3.0	.050A	.180W	.175J	800.000G	1UA	45V	96	.001A	
40482	N	S	RCA	218	TO 104	45	3.0	.050A	.180W	.175J	800.000G	1UA	45V	140	.001A	
40487	P	G	RCA	120	TO 1	50	34X	5	.010A	.080W	85J	860.000G	1UA	45V	48	.001A
40488	P	G	RCA	120	TO 1	12	12X	1.5	.010A	.080W	85J	40.000G	12UA	12V	150	.001A
40489	P	G	RCA	120	TO 1	50	34X	5	.010A	.080W	85J	30.000G	2UA	12V	80	.001A
40490	P	G	RCA	120	TO 1	20	18R	2.5	.020A	.120W	100J	10.000G	12UA	20V	300	.001A
40517	N	S	RCA	217	TO 72	300	300	2.0	1.50A	3.800W	150J	25.000G	100UA	30V	60	.050A
40518	N	S	RCA	217	TO 72	30	15	2.5	.040A	.200W	200J	1000.000G	10NA	15V	66	.003A
40519	N	S	RCA	211	TO 52	16	5.0	.500A	.300W	.175J	300.000G	25NA	20V	40	.050A	
40537	P	S	RCA	211	TO 5	55R	5.0	.700A	1.000W	200J	100.000G	10UA	45V	125	.050A	
40538	P	S	RCA	211	TO 5	55R	5.0	.700A	1.000W	200J	100.000G	10UA	45V	37	.500A	
40539	N	S	RCA	980	980A	50R	5.0	6.000A	83.000W	150J	800G	1MA	40V	38	3.000A	
40542	N	S	RCA	980	980A	50R	5.0	.700A	7.000W	200J	100.000G	10UA	40V	85	.050A	
40543	N	S	RCA	635	635B	60R	5.0	8.000A	83.000W	150J	800G	1MA	50V	38	3.000A	
40544	N	S	RCA	605	TO 66	250X	2.0	1.50A	8.000W	150J	25.000G	100UA	250V	88	.050A	
40546	N	S	RCA	605	TO 66	250X	2.0	1.50A	8.000W	150J	25.000G	100UA	250V	82	.050A	
40577	SEE	RF POWER SECTION														
40578	SEE	RF POWER SECTION														
40581	SEE	RF POWER SECTION														
40582	SEE	RF POWER SECTION														
40594	N	S	RCA	211	TO 5	95R	4.0	2.000A	1.200W	200J	50.000G	10UA	85V	158	.300A	
40595	N	S	RCA	211	TO 5	95R	4.0	2.000A	1.200W	200J	50.000G	10UA	85V	158	.300A	
40605	SEE	RF POWER SECTION														
40608	N	S	RCA	211	TO 39	40	40R	2.0	.400A	3.500W	200J	700.000G	100UA	20V	65	.050A
40611	N	S	RCA	211	TO 5	25	2.5	7.0A	1.000W	200J	50.000G	500NA	30V	112	.150A	
40612	P	G	RCA	605	TO 3	25R	5.0	5.000A	12.500W	100J	.300G</					

Transistor Type No.	N / G / P / S	Manufacturer	Lead Ident	Out- line	Maximum (V)			Maximum		Max. T.(°C)	Frequency Resp.(MHz)	Leakage		Gain	
					V _{CE}	V _{CE}	V _{CE}	I _C	Power			I _{CE0} @ V _{CE}	V _{CE}	h _{FE} @ I _C	
40637	N S	RCA	211	TO 52			30S 5.0	.100A	.300W	175J	100.000G				
40665	SEE	RF POWER SECTION													
40666	SEE	RF POWER SECTION													
95101	SEE	2N1526													
95102	SEE	2N1524													
95103	SEE	2N1524													
95107	SEE	2N1526													
95108	SEE	2N1745													
95109	SEE	2N501													
95110	SEE	2N501													
95111	SEE	2N1865													
95112	SEE	2N2711													
95113	SEE	2N2712													
95114	SEE	2N193													
95115	SEE	2N211													
95116	SEE	2N769													
95117	SEE	2N769													
95201	SEE	2N406													
95202	SEE	2N649													
95203	SEE	2N408													
95204	SEE	2N270													
95208	SEE	2N2374													
95209	SEE	2N2376													
95212	SEE	2N321													
95214	SEE	2N406													
99101	SEE	2SA84													
99102	SEE	2SA83													
99103	SEE	2SA15													
99104	SEE	2SA15													
99201	SEE	2SB75													
99203	SEE	2SB77													
99204	SEE	2SB89													
A104	-N S	AMP	211	TO 18	20		4.0	.030A	.300W		30.000G	100NA	100		
A106	-N S	AMP	211	TO 18	20		4.0	.030A	.300W		30.000G	100NA	90		
A108	-N S	AMP	211	TO 18	20		4.0	.030A	.300W		30.000G	100NA	180		
A110	-N S	AMP	211	TO 18	20		4.0	.030A	.300W		30.000G	100NA	360		
A111	-N S	AMP	211	TO 18	30		4.0	.030A	.300W		30.000G	100NA	180		
A115	-N S	AMP	211	TO 18	30		4.0	.030A	.300W		30.000G	110NA	50		
A116	-N S	AMP	211	TO 18	30		4.0	.030A	.300W		30.000G	100NA	110		
A130	-N S	AMP	211	TO 5	90		4.0	.030A	.300W		20.000G	500NA			
A141	-N S	AMP	43	43A	20			.050A	.030W		150.000G		130	.001A	
A142	-N S	AMP	43	43A	20			.050A	.030W		150.000G		220	.001A	
A143	-N S	AMP	43	43A	20			.050A	.030W		150.000G		380	.001A	
A151	-N S	AMP	133	133A	20			.050A	.030W		150.000G		130	.001A	
A152	-N S	AMP	133	133A	20			.050A	.030W		150.000G		220	.001A	
A153	-N S	AMP	210	TO 18	45		5.0	.100A	.300W		300.000G		300	.002A	
A157B	-N S	AMP	210	TO 18	45		5.0	.100A	.300W		300.000G		600	.002A	
A157C	-N S	AMP	210	TO 18	45		5.0	.100A	.300W		300.000G		600	.002A	
A158B	-N S	AMP	210	TO 18	20		5.0	.100A	.300W		300.000G		300	.002A	
A158C	-N S	AMP	210	TO 18	20		5.0	.100A	.300W		300.000G		400	.002A	
A159B	-N S	AMP	210	TO 18	20		5.0	.100A	.300W		300.000G		600	.002A	
A159C	-N S	AMP	210	TO 18	20		5.0	.100A	.300W		300.000G		140	.002A	
A177	P S	AMP	210	TO 18	50			.200A	.300W		130.000G		180	.002A	
A178A	P S	AMP	210	TO 18		25	5.0	.100A	.300W		130.000G		180	.002A	
A178B	P S	AMP	210	TO 18		25	5.0	.100A	.300W		130.000G		180	.002A	
A179A	P S	AMP	210	TO 18		25	5.0	.100A	.300W		130.000G		290	.002A	
A201	N S	AMP	540	TO 60	36			1.500A	11.600W		400.000G		3		
A202	N S	AMP	540	TO 60	36			3.000A	23.200W		400.000G		3		
A210	N S	AMP	210	TO 39	40			.200A	.700W		1200.000G		38	.150A	
A211	N S	AMP	210	TO 39	40			.200A	.700W		800.000G		38	.150A	
A306	-N S	AMP	210	TO 18	25	20	5.0		.360W	200J	100.000G	10NA	15V	140	
A307	-N S	AMP	210	TO 18	25	20	5.0		.360W	200J	100.000G	10NA	15V	350	
A310	-N S	AMP	211	TO 5	80		3.0		.300W		60.000G	500NA		20	
A311	-N S	AMP	211	TO 5	80		3.0		.300W		60.000G	500NA		20	
A323	-N S	AMP	211	TO 18	60		6.0	.030A	.300W	175J	30.000G	10NA	45V	270	.010A
A324	-N S	AMP	211	TO 18	60		6.0	.030A	.300W	175J	30.000G	10NA	45V	450	.010A
A344	-N S	AMP	210	TO 18	20	15	5.0	.200A	.300W	175J	350.000G	100NA	20V	32	.100A
A345	-N S	AMP	210	TO 18	20	15	5.0	.200A	.300W	175J	350.000G	100NA	20V	26	.100A
A346	-N S	AMP	210	TO 18	20	15	5.0	.200A	.300W	175J	350.000G	100NA	20V	38	.100A
A321	N S	AMP	211	TO 18	30		5.0	.030A	.300W		30.000G	100NA	30V	80	.001A
A322	N S	AMP	211	TO 18	30		5.0	.030A	.300W		30.000G	100NA	30V	300	.001A
A415	N S	AMP	218	TO 72	50	10		.030A	.165W		200.000G		10		
A417	N S	AMP	218	TO 72	20	5.0		.030A	.145W		250.000G		22		
A418	N S	AMP	218	TO 72	20	5.0		.030A	.145W		200.000G		22		
A419	N S	AMP	218	TO 72	20	5.0		.030A	.145W		200.000G		90		
A420	N S	AMP	218	TO 72	20	5.0		.030A	.145W		200.000G		112		
A430	N S	AMP	217	TO 72	10	2.5		.050A	.250W		1600.000G		8		
A467	N S	AMP	218	TO 72	40			.030A	.150W		235.000G		80		
A473	N S	AMP	218	TO 72	40			.035A	.230W		550.000G		100		
A482	N S	AMP	218	TO 72	10			.015A	.130W		675.000G				
A483	N S	AMP	218	TO 72	10			.015A	.130W		600.000G				
A484	N S	AMP	218	TO 72				.020A	.130W		550.000G				
A485	N S	AMP	217	TO 72	30	2.5		.030A	.200W	200J	1000.000G	10NA	15V	63	.002A
A490	N S	AMP	217	TO 72	30	2.5		.030A	.200W	200J	1000.000G	10NA	15V	70	.015A
A492	N S	AMP	217	TO 72	30	2.5		.030A	.200W	200J	800.000G	10NA	15V	25	.002A
A496	N S	AMP	984	984A				.025A	.250W		400.000G				
A497	N S	AMP	984	984A				.025A	.250W		550.000G				
A667-GRN	-N S	GEC	45	TO 98	18	18	5.0	.100A	.200W	100J		500NA	18V	350	
A667-ORG	-N S	GEC	45	TO 98	18	18	5.0	.100A	.200W	100J		500NA	18V	136	
A667-YEL	-N S	GEC	45	TO 98	18	18	5.0	.100A	.200W	100J		500NA	18V	76	
A668-GRN	-N S	GEC	45	TO 98	18	18	5.0	.100A	.200W	100J		500NA	18V	224	
A668-ORG	-N S	GEC	45	TO 98	18	18	5.0	.100A	.200W	100J		500NA	18V	350	
A668-YEL	-N S	GEC	45	TO 98	18	18	5.0	.100A	.200W	100J		500NA	18V	136	
A669-GRN	-N S	GEC	45	TO 98	18	18	5.0	.100A	.200W	100J		500NA	18V	224	
A669-YEL	-N S	GEC	45	TO 98	18	18	5.0	.100A	.200W	100J		500NA	18V	350	
A74	N S	AMP	985	985A											

Transistor Type No.	N P S	C P S	Manufacturer	Lead Ident	Out- line	Maximum (V)			Maximum		Max. T.(°C)	Frequency Resp.(MHz)	Leakage I_{BO} @ V_{CE}	Gain h_{FE} @ I_C			
						V_{CE}	V_{BE}	V_{ES}	I_C	Power							
AF201	P	G	SIH	218	218E	25	3	3	0.1A	.225W	90J	1000.000G	10UA	12V	85	.003A	
AF202	P	G	SIH	218	218E	32	3	3	0.30A	.225W	90J	1000.000G	10UA	12V	85	.003A	
AF239	P	G	SIH	217	217E	20	15	3	0.10A	.060W	100J	600.000G	10UA	20V	40	.002A	
AF239S	P	G	MOT,SIH	217	TO 72	20S	3	3	0.10A	.060W	90J	780.000G	8UA	20V	50	.002A	
AF240	P	G	SIH	217	TO 72	20S	3	3	0.10A	.060W	90J	780.000G	8UA	20V	50	.002A	
AF279	P	G	SIH	217	TO 72	20S	3	3	0.10A	.060W	90J	780.000G	8UA	20V	50	.002A	
AF280	P	G	SIH	906	906A	20S	3	3	0.10A	.060W	90J	550.000G	15UA	20V	25	.002A	
AFY11	P	G	SIH	211	TO 39	30	15	1.0	0.70A	.560W	90J	350.000G	18UA	15V	60	.010A	
AFY12	P	G	TFK,SIH	217	TO 72	25	18	5.0	0.10A	.060W	90J	230.000G	7000A	2UA	6V	4D	.200A
AFY14	P	G	TFK	211	TO 39	30	15	1.0	0.70A	.560W	90J	350.000G	18UA	15V	60	.010A	
AFY15	P	G	SIH	217	TO 72	25	18	5.0	0.10A	.060W	90J	230.000G	7000A	2UA	6V	4D	.200A
AFY16	P	G	TFK,SIH	217	TO 72	30	20	8.0	0.08A	.060W	90J	500.000G	7000A	20V	50	.005A	
AFY18	P	G	SIH	211	TO 39	30	15	1.0	0.70A	.560W	90J	350.000G	18UA	15V	60	.010A	
AFY19	P	G	SIH	210	TO 5	34	34	3	0.20A	1.520W	90J	600.000G	10UA	20V	40	.002A	
AFY37	P	G	SIH	217	TO 72	32	3	3	0.30A	.225W	90J	500.000G	10UA	12V	85	.003A	
AFY39	P	G	SIH	217	TO 72	32	3	3	0.30A	.225W	90J	500.000G	10UA	12V	85	.003A	
AFY42	P	G	SIH	217	TO 72	30	25	3	0.10A	.112W	90J	700.000G	30UA	20V	50	.002A	
AFZ10	P	G	TFK	55	55F	40	30	7	1.00A	.150W	75J	50.000G					
AFZ12	P	G	RAO	217	TO 72	20	20	5	0.10A	.083W	90J	180.000B					
ALZ10	P	N	SIH	698	698A	50	28	6	5.00A	.500W	75J	40.000G	2UA	6V	40	.010A	
AMF101	P	N	AMF	731	TO 53	30	30S	5	4.00A	85.000W	200J	1.000B	2MA	15V	30		
AMF102	P	N	AMF	731	TO 53	60	60S	5	4.00A	85.000W	200J	1.000B	1MA	15V	30		
AMF103	P	N	AMF	731	TO 53	100	100S	5	4.00A	85.000W	200J	1.000B	1MA	15V	30		
AMF104	P	N	AMF	605	TO 3	30	30S	5	4.00A	75.000W	200J	1.000B	2MA	15V	30		
AMF105	P	N	AMF	605	TO 3	60	60S	5	4.00A	75.000W	200J	1.000B	1MA	15V	30		
AMF106	P	N	AMF	605	TO 3	100	100S	5	4.00A	75.000W	200J	1.000B	1MA	15V	30		
AMF107	P	N	AMF	561	TO 61	30	30S	5	4.00A	85.000W	200J	1.500B	2MA	15V	34		
AMF108	P	N	AMF	561	TO 61	60	60S	5	4.00A	85.000W	200J	1.500B	1MA	15V	34		
AMF109	P	N	AMF	561	TO 61	100	100S	5	4.00A	85.000W	200J	1.500B	1MA	15V	34		
AMF110	P	N	AMF	561	TO 61	60	60S	5	4.00A	85.000W	200J	1.500B	1MA	15V	34		
AMF111	P	N	AMF	561	TO 61	60	60S	5	7.500A	85.000W	200J	1.500B	1MA	15V	34		
AMF112	P	N	AMF	731	TO 53	60	60S	5	7.500A	85.000W	200J	1.500B	1MA	15V	30		
AMF113	P	N	AMF	731	TO 53	60	60S	5	7.500A	85.000W	200J	1.500B	1MA	15V	30		
AMF114	P	N	AMF	561	TO 61	60	60S	5	7.500A	85.000W	200J	1.500B	1MA	15V	34		
AMF115	P	N	AMF	605	TO 3	60	60S	5	7.500A	75.000W	200J	1.000B	1MA	15V	30		
AMF116	P	N	AMF	605	TO 3	60	60S	5	7.500A	75.000W	200J	1.000B	1MA	15V	30		
AMF117	P	N	AMF	605	TO 3	55	55S	5	4.00A	75.000W	200J	1.000B	10MA	55V	30		
AMF117A	P	N	AMF	605	TO 3	55	55S	5	4.00A	75.000W	200J	1.000B	10MA	55V	30		
AMF118	P	N	AMF	605	TO 3	45	45S	5	4.00A	75.000W	200J	1.000B	10MA	45V	30		
AMF118A	P	N	AMF	605	TO 3	45	45S	5	4.00A	75.000W	200J	1.000B	10MA	45V	30		
AMF119	P	N	AMF	605	TO 3	35	35S	5	4.00A	75.000W	200J	1.000B	10MA	35V	30		
AMF119A	P	N	AMF	605	TO 3	35	35S	5	4.00A	75.000W	200J	1.000B	10MA	35V	30		
AMF120	P	N	AMF	605	TO 3	25	25S	5	4.00A	75.000W	200J	1.000B	10MA	25V	30		
AMF120A	P	N	AMF	605	TO 3	25	25S	5	4.00A	75.000W	200J	1.000B	10MA	25V	30		
AMF121	P	N	AMF	731	TO 53	55	55S	5	4.00A	85.000W	200J	1.000B	10MA	55V	30		
AMF121A	P	N	AMF	731	TO 53	55	55S	5	4.00A	85.000W	200J	1.000B	10MA	55V	30		
AMF122	P	N	AMF	731	TO 53	45	45S	5	4.00A	85.000W	200J	1.000B	10MA	45V	30		
AMF122A	P	N	AMF	731	TO 53	45	45S	5	4.00A	85.000W	200J	1.000B	10MA	45V	30		
AMF123	P	N	AMF	731	TO 53	35	35S	5	4.00A	85.000W	200J	1.000B	10MA	35V	30		
AMF123A	P	N	AMF	731	TO 53	35	35S	5	4.00A	85.000W	200J	1.000B	10MA	35V	30		
AMF124	P	N	AMF	731	TO 53	25	25S	5	4.00A	85.000W	200J	1.000B	10MA	25V	30		
AMF124A	P	N	AMF	731	TO 53	25	25S	5	4.00A	85.000W	200J	1.000B	10MA	25V	30		
AMF201	P	N	AMF	605	TO 3	30	30S	5	13.000A	85.000W	160J	1.000B	3MA	15V	20		
AMF201B	P	N	AMF	605	TO 3	80	80S	5	13.000A	85.000W	160J	1.000B	3MA	30V	20		
AMF201C	P	N	AMF	605	TO 3	100	100S	5	13.000A	85.000W	160J	1.000B	3MA	30V	20		
AMF201D	P	N	AMF	605	TO 3	100	100S	5	8.000A	80.000W	175J	1.500B	2MA	15V	20		
AMF210	P	N	AMF	605	TO 3	30	30S	5	8.000A	80.000W	175J	1.500B	2MA	30V	20		
AMF210A	P	N	AMF	605	TO 3	60	60S	5	8.000A	80.000W	175J	1.500B	2MA	30V	20		
AMF210B	P	N	AMF	605	TO 3	100	100S	5	8.000A	80.000W	175J	1.500B	2MA	30V	20		
AMF210C	P	N	AMF	605	TO 3	150	150S	5	4.00A	80.000W	175J	1.000B	2MA	30V	20		
AMF227A	P	N	AMF	412	TO 82	30	30S	5	7.500A	175.000W	150J	.020E	20MA	30V	20		
AMF227B	P	N	AMF	412	TO 82	60	60S	5	7.500A	175.000W	150J	.020E	20MA	60V	20		
AMF227C	P	N	AMF	412	TO 82	100	100S	5	7.500A	175.000W	150J	.020E	20MA	100V	20		
AMF227D	P	N	AMF	412	TO 82	150	150S	5	7.500A	175.000W	150J	.020E	20MA	150V	20		
AMF228	P	N	AMF	412	TO 82	30	30S	5	7.500A	175.000W	150J	.020E	20MA	30V	20		
AMF228B	P	N	AMF	412	TO 82	60	60S	5	7.500A	175.000W	150J	.020E	20MA	60V	20		
AMF228C	P	N	AMF	412	TO 82	100	100S	5	7.500A	175.000W	150J	.020E	20MA	100V	20		
AMF228D	P	N	AMF	412	TO 82	150	150S	5	7.500A	175.000W	150J	.020E	20MA	150V	20		
AMF229	P	N	AMF	412	TO 82	30	30S	5	4.00A	175.000W	150J	.020E	20MA	30V	20		
AMF229A	P	N	AMF	412	TO 82	60	60S	5	4.00A	175.000W	150J	.020E	20MA	60V	20		
AMF229B	P	N	AMF	412	TO 82	100	100S	5	4.00A	175.000W	150J	.020E	20MA	100V	20		
AMF229C	P	N	AMF	412	TO 82	150	150S	5	4.00A	175.000W	150J	.020E	20MA	150V	20		
ASY23	P	G	RAO	210	TO 5	80	60	20.0	3.00A	.180W	75J	7.00B	2UA	6V	66	.200A	
ASY24	P	G	TFK	210	TO 5	150	25	7	2.50A	.065W	85J	22.000G	3UA	5V	65	.200A	
ASY24B	P	G	TFK	210	TO 210C	35	20	6	2.50A	.065W	85J	22.000G	3UA	5V	65	.200A	
ASY26	P	G	RAO,SIH,TFK	210	TO 5	30	25	20.0	1.00A	.125W	75J	4.000B	2UA	5V	30	.100A	
ASY27	P	G	RAO,SIH,TFK	210	TO 5	25	20	20.0	1.00A	.125W	75J	6.000B	2UA	5V	30	.100A	
ASY28	P	G	RAO,TFK	210	TO 5	30	25	20.0	1.00A	.125W	75J	4.000B	2UA	5V	30	.100A	
ASY29	P	G	RAO,TFK	210	TO 5	25	20	20.0	1.00A	.125W	75J	6.000B	2UA	5V	30	.100A	
ASY30	P	G	SIH	210	TO 2100	50	25	7	2.50A	.200W	85J	22.000G	2UA	6V	66	.200A	
ASY48	P	G	SIH	120	TO 1	64	45	16.0	3.00A	.900W	90J	1.200G	18UA	64V	68	.100A	
ASY70	P	G	SIH	120	TO 1	32	30	16.0	3.00A	.900W	90J	1.500G	18UA	32V	68	.100A	
ASZ15	P	G	RAO	605	TO 3	80	60	40.0	8.00A	43.000W	90J	.250B					
ASZ16	P	G	RAO	605	TO 3	60	48	20.0	8.00A	43.000W	90J	.250B					
ASZ17	P	G	RAO	605	TO 3	60	48	20.0	8.00A	43.000W	90J	.250B					
ASZ18	P	G	RAO	605	TO 3	80	60	40.0	8.00A	43.000W	90J	.250B					
ASZ21	P	G	RAO	210	TO 18	20	15	2.5	0.30A	.100W	75A	300.000B					
AT10H</																	

Transistor Type No.	N P	G S	Manufacturer	Lead Ident	Out- line	Maximum (V)			Maximum I _c	Maximum Power	Max. T _j (°C)	Frequency Resp.(MHz)	Leakage		Gain	
						V _{CE}	V _{ES}	V _{ES}					I _{CE0} @ V _{CE}	I _{CE0} @ V _{CE}	f _β @ I _c	f _β @ I _c
B1013			SEE 2N2282													
B1013A			SEE 2N2283													
B1274			SEE 2N2291													
B1274A			SEE 2N2292													
B1274B			SEE 2N2293													
B3456	N	S	SEE 2N4225	561	TO 61	100	60	6.0	10.000A	25.000W	200J	200.000G	25UA	15V	60	5.000A
B3458	N	S	SEE 2N4226	561	TO 5	100	60	6.0	5.000A	7.500W	200J	200.000G	25UA	15V	60	5.000A
B3459	N	S		561	TO 61	80	40	8.0	10.000A	25.000W	200J	200.000G	5UA	30V	80	1.000A
B3459A	N	S		561	TO 61	100	60	8.0	10.000A	25.000W	200J	200.000G	5UA	30V	80	1.000A
B3460			SEE 2N4225													
B3461			SEE 2N4226													
B3465	N	S		210	TO 5	100	60	6.0	3.000A	5.000W	175J	200.000G	100NA	30V	80	1.000A
B3466	N	S		540	540B	100	60	6.0	3.000A	5.000W	175J	200.000G	100NA	30V	80	1.000A
B3531	N	S		211	TO 5	80	40	8.0	5.000A	4.000W	200J	30.000G	1UA	60V	36	1.000A
B3532	N	S		211	TO 5	100	80	8.0	5.000A	4.000W	200J	30.000G	1UA	60V	36	1.000A
B3533	N	S		211	TO 5	80	40	8.0	5.000A	4.000W	200J	30.000G	1UA	60V	36	1.000A
B3534	N	S		211	TO 5	80	40	8.0	5.000A	4.000W	200J	30.000G	1UA	60V	36	1.000A
B3535	N	S		211	TO 5	100	80	8.0	5.000A	4.000W	200J	30.000G	1UA	60V	36	1.000A
B3536	N	S		211	TO 5	100	80	8.0	5.000A	4.000W	200J	30.000G	1UA	60V	36	1.000A
B3537	N	S		211	TO 5	100	80	8.0	5.000A	4.000W	200J	30.000G	1UA	60V	36	1.000A
B3538	N	S		541	541B	60	40	5.0	6.00A	10.000W	200J	40.000G	2UA	60V	50	150A
B3539	N	S		541	541B	120	70	5.0	6.00A	10.000W	200J	50.000G	1UA	30V	50	150A
B3540	N	S		541	541B	60	40	5.0	6.00A	10.000W	200J	50.000G	1UA	30V	36	150A
B3541	N	S		541	541B	60	40	5.0	6.00A	10.000W	200J	50.000G	1UA	30V	70	150A
B3542	N	S		541	541B	60	40	5.0	6.00A	10.000W	200J	50.000G	1UA	30V	36	150A
B3543	N	S		541	541B	80	60	5.0	6.00A	10.000W	200J	50.000G	1UA	30V	36	150A
B3544	N	S		541	541B	80	60	5.0	6.00A	10.000W	200J	50.000G	1UA	30V	36	150A
B3545	N	S		541	541B	80	60	5.0	6.00A	10.000W	200J	50.000G	1UA	30V	36	150A
B3546	N	S		541	541B	120	80	5.0	6.00A	10.000W	200J	50.000G	1UA	30V	160	150A
B3547	N	S		561	TO 59	60	40	8.0	5.000A	30.000W	200J	50.000G	2UA	60V	36	150A
B3548	N	S		561	TO 59	80	60	8.0	5.000A	30.000W	200J	50.000G	1UA	80V	36	1.000A
B3549	N	S		561	TO 59	100	80	8.0	5.000A	30.000W	200J	50.000G	1UA	100V	36	1.000A
B3550	N	S		561	TO 59	60	40	8.0	5.000A	30.000W	200J	50.000G	1UA	60V	70	1.000A
B3551	N	S		561	TO 59	100	80	8.0	5.000A	30.000W	200J	50.000G	1UA	80V	70	1.000A
B3552	N	S		561	TO 59	100	80	8.0	5.000A	30.000W	200J	50.000G	1UA	100V	70	1.000A
B3553	N	S		561	TO 59	60	40	8.0	5.000A	30.000W	200J	50.000G	1UA	60V	70	1.000A
B3554	N	S		561	TO 59	60	40	8.0	5.000A	30.000W	200J	50.000G	1UA	60V	160	1.000A
B3555	N	S		561	TO 59	80	60	8.0	5.000A	30.000W	200J	50.000G	1UA	80V	160	1.000A
B3556	N	S		561	TO 59	100	80	8.0	5.000A	30.000W	200J	50.000G	1UA	100V	160	1.000A
B3557	N	S		561	TO 59	60	40	8.0	5.000A	30.000W	200J	50.000G	1UA	60V	70	1.000A
B3558	N	S		561	TO 59	120	80	8.0	5.000A	20.000W	200J	20.000G	100NA	60V	70	1.000A
B3559	N	S		561	TO 59	150	100	8.0	5.000A	20.000W	200J	20.000G	100NA	60V	70	1.000A
B3560	N	S		561	TO 59	80	60	8.0	5.000A	30.000W	200J	30.000G	100NA	30V	36	1.000A
B3561	N	S		561	TO 59	100	80	8.0	5.000A	30.000W	200J	30.000G	100NA	60V	36	1.000A
B3562	N	S		561	TO 59	60	40	8.0	5.000A	30.000W	200J	40.000G	100NA	30V	70	1.000A
B3563	N	S		561	TO 59	60	40	8.0	5.000A	30.000W	200J	40.000G	100NA	60V	70	1.000A
B3564	N	S		561	TO 59	100	80	8.0	5.000A	30.000W	200J	40.000G	100NA	60V	70	1.000A
B3565	N	S		561	TO 59	60	40	8.0	5.000A	30.000W	200J	40.000G	100NA	60V	70	1.000A
B3566	N	S		561	TO 59	80	60	8.0	5.000A	30.000W	200J	50.000G	100NA	30V	176	1.000A
B3567	N	S		561	TO 59	100	80	8.0	5.000A	30.000W	200J	50.000G	100NA	60V	176	1.000A
B3568	N	S		541	541B	120	80	5.0	6.00A	10.000W	200J	50.000G	2UA	60V	70	150A
B3569	N	S		541	541B	80	40	5.0	6.00A	10.000W	200J	50.000G	2UA	60V	160	150A
B3570	N	S		541	541B	100	80	8.0	5.000A	10.000W	200J	30.000G	1UA	60V	36	1.000A
B3571	N	S		541	541B	80	40	8.0	5.000A	10.000W	200J	30.000G	1UA	60V	70	1.000A
B3572	N	S		541	541B	100	80	8.0	5.000A	10.000W	200J	30.000G	1UA	60V	70	1.000A
B3573	N	S		541	541B	100	80	8.0	5.000A	10.000W	200J	30.000G	1UA	60V	70	1.000A
B3574	N	S		541	541B	100	80	8.0	5.000A	10.000W	200J	30.000G	1UA	60V	70	1.000A
B3575	N	S		541	541B	100	80	8.0	5.000A	10.000W	200J	30.000G	1UA	60V	160	1.000A
B3576	N	S		541	541B	60	40	5.0	5.000A	10.000W	200J	30.000G	1UA	60V	160	1.000A
B3577	N	S		561	TO 59	100	50	5.0	5.000A	40.000W	200J	30.000G	1UA	60V	20	1.000A
B3578	N	S		561	TO 59	80	40	8.0	5.000A	40.000W	200J	30.000G	1UA	60V	36	1.000A
B3579	N	S		561	TO 59	100	80	8.0	5.000A	40.000W	200J	30.000G	1UA	60V	36	1.000A
B3580	N	S		561	TO 59	80	40	8.0	5.000A	40.000W	200J	30.000G	1UA	60V	36	1.000A
B3581	N	S		561	TO 59	100	80	8.0	5.000A	40.000W	200J	30.000G	1UA	60V	70	1.000A
B3582	N	S		561	TO 59	60	40	8.0	5.000A	40.000W	200J	30.000G	1UA	60V	70	1.000A
B3583	N	S		561	TO 59	100	80	8.0	5.000A	40.000W	200J	30.000G	1UA	60V	160	1.000A
B3584	N	S		561	TO 59	60	40	8.0	5.000A	40.000W	200J	30.000G	1UA	60V	160	1.000A
B3585	N	S		561	TO 61	60	40	8.0	5.000A	30.000W	200J	30.000G	1UA	60V	36	1.000A
B3586	N	S		561	TO 61	100	80	8.0	5.000A	30.000W	200J	30.000G	1UA	60V	36	1.000A
B3587	N	S		561	TO 61	60	40	8.0	5.000A	30.000W	200J	30.000G	1UA	60V	36	1.000A
B3588	N	S		561	TO 61	100	80	8.0	5.000A	30.000W	200J	30.000G	1UA	60V	36	1.000A
B3589	N	S		561	TO 61	60	40	8.0	5.000A	30.000W	200J	30.000G	1UA	60V	70	1.000A
B3590	N	S		561	TO 61	100	80	8.0	5.000A	30.000W	200J	30.000G	1UA	60V	70	1.000A
B3591	N	S		561	TO 61	60	40	8.0	5.000A	30.000W	200J	30.000G	1UA	60V	70	1.000A
B3592	N	S		561	TO 61	80	60	8.0	5.000A	30.000W	200J	30.000G	1UA	60V	160	1.000A
B3593	N	S		211	TO 5	80	40	8.0	5.000A	5.000W	200J	30.000G	1UA	60V	70	5.000A
B3594	N	S		211	TO 5	100	80	8.0	5.000A	5.000W	200J	30.000G	1UA	60V	70	5.000A
B3595	N	S		211	TO 5	80	40	8.0	5.000A	5.000W	200J	15.000G	1UA	60V	36	5.000A
B3596	N	S		211	TO 5	100	80	8.0	5.000A	5.000W	200J	15.000G	1UA	60V	36	5.000A
B3597	N	S		211	TO 5	60	40	5.0	10.000A	5.000W	200J	15.000G	1UA	30V	36	5.000A
B3598	N	S		211	TO 5	80	40	5.0	10.000A	5.000W	200J	15.000G	1UA	60V	36	5.000A
B3599	N	S		211	TO 5	100	80	5.0	10.000A	5.000W	200J	15.000G	1UA	60V	36	5.000A
B3600	N	S		211	TO 5	60	40	5.0	10.000A	5.000W	200J	15.000G	1UA	60V	36	5.000A
B3601	N	S		211	TO 5	80	60	5.0	10.000A	5.000W	200J	15.000G	1UA	60V	70	5.000A
B3602	N	S		211	TO 5	100	80	5.0	10.000A	5.000W	200J	15.000G	1UA	60V	70	5.000A
B3603	N	S		211	TO 5	60	40	5.0	10.000A	5.000W	200J	15.000G	1UA	60V	70	5.000A

Transistor Type No.	N P	G S	Manufacturer	Lead Ident	Out- line	Maximum (V)			Maximum Power		Max. T.(°C)	Frequency (MHz)	Leakage		Gain	
						V _{BO}	V _{CS}	V _{ES}	P _r	P _o			I _{BO}	I _{CS}	I _{ES}	h _{FE}
B3629	N	S	BEN	541	541B	80	60	8.0	5.000A	10.000W	200J	20.000G	100NA	60V	70	1.000A
B3630	N	S	BEN	541	541B	100	80	8.0	5.000A	10.000W	200J	20.000G	100NA	60V	70	1.000A
B3631	N	S	BEN	560	TO 59	80	60	8.0	5.000A	30.000W	200J	30.000G	100NA	60V	36	1.000A
B3632	N	S	BEN	560	TO 59	80	60	8.0	5.000A	30.000W	200J	50.000G	100NA	60V	70	1.000A
B3633	N	S	BEN	560	TO 59	100	80	8.0	5.000A	30.000W	200J	30.000G	100NA	60V	36	1.000A
B3634	N	S	BEN	560	TO 59	100	80	8.0	5.000A	30.000W	200J	50.000G	100NA	60V	70	1.000A
B3746	N	S	BEN	218	TO 18	20	0	0	8.00A	0.000W	200J	50.000G	10MA	20V	40	.010A
B3747	N	S	BEN	541	541B	25	25	8.00A	0.000A	0.000W	200J	10MA	25V	40	.010A	
B3748	N	S	BEN	541	541B	25	25	8.00A	0.000A	0.000W	200J	10MA	25V	40	.010A	
B3749	N	S	BEN	541	541B	50	50	5.000A	0.000A	0.000W	200J	10MA	50V	40	.010A	
B3750	N	S	BEN	920	920A	35	1.2	3.000A	25.000W	150J	2.300G	2MA	14V	90	.500A	
B5001	N	S	BEN	610	610A	35	1.2	3.000A	45.000W	200J	2.300G	2MA	14V	90	.500A	
B5002	N	S	BEN	920	920A	35	1.2	3.000A	45.000W	200J	2.300G	2MA	14V	52	.500A	
B5020	N	S	BEN	920	920A	35	1.2	3.000A	45.000W	200J	2.300G	2MA	14V	52	.500A	
B5021	N	S	BEN	610	610A	60	1.2	3.000A	45.000W	200J	2.300G	2MA	14V	52	.500A	
B5022	N	S	BEN	920	920A	35	1.2	3.000A	45.000W	200J	2.300G	2MA	14V	52	.500A	
B5030	N	S	BEN	610	610A	60	1.2	3.000A	45.000W	200J	2.300G	2MA	14V	52	.500A	
B5031	N	S	BEN	920	920A	35	1.2	3.000A	45.000W	150J	2.300G	2MA	14V	50	.500A	
B5032	N	S	BEN	610	610A	35	1.2	3.000A	45.000W	200J	2.300G	2MA	14V	90	.500A	
B5040	N	S	BEN	920	920A	35	1.2	3.000A	25.000W	150J	2.300G	2MA	14V	50	.500A	
B5041	N	S	BEN	610	610A	60	1.2	3.000A	45.000W	200J	2.300G	2MA	14V	90	.500A	
B5042	N	S	BEN	920	920A	35	1.2	3.000A	45.000W	200J	2.300G	2MA	14V	200	.500A	
B5050	N	S	BEN	610	610A	60	1.2	3.000A	45.000W	200J	2.300G	2MA	14V	200	.500A	
B5051	N	S	BEN	920	920A	35	1.2	3.000A	45.000W	200J	2.300G	2MA	14V	200	.500A	
B5052	N	S	BEN	610	610A	60	1.2	3.000A	45.000W	200J	2.300G	2MA	14V	200	.500A	
B5106	N	S	BEN	920	920A	60	60	3.000A	45.000W	2.000G	2.000G	2MA	14V	99	.500A	
B5120	N	S	BEN	920	920A	60	60	3.000A	45.000W	2.000G	2.000G	2MA	14V	90	.500A	
B5130	N	S	BEN	920	920A	60	60	3.000A	45.000W	2.000G	2.000G	2MA	14V	143	.500A	
B5140	N	S	BEN	920	920A	60	60	3.000A	45.000W	2.000G	2.000G	2MA	14V	210	.500A	
B5150	N	S	BEN	920	920A	60	60	3.000A	45.000W	2.000G	2.000G	2MA	14V	143	.500A	
B10142	-P	G	BEN	605	TO 3	350		10.000A	30.000W	110J	.008E	200UA	2V	40	6.000A	
B10142A	-P	G	BEN	605	TO 3	290		10.000A	30.000W	110J	.008E	200UA	2V	40	6.000A	
B10142B	-P	G	BEN	605	TO 3	225		10.000A	30.000W	110J	.008E	200UA	2V	40	6.000A	
B10174	-P	G	BEN	605	TO 3	60		10.000A	40.000W	110J	.008E	2MA	60V	150	.400A	
B10475	-P	G	BEN	605	TO 3	60		10.000A	40.000W	110J	.008E	2MA	100V	150	.400A	
B10912	-P	G	BEN	605	TO 3	35	10	3.000A	30.000W	100J	.008E	2MA	40V	102	1.000A	
B10913	-P	G	BEN	605	TO 3	40	30	7.000A	45.000W	100J	.300G	2MA	40V	102	1.000A	
B102000	P	P	G	605	TO 3	50	40	7.000A	45.000W	100J	.300G	2MA	40V	102	1.000A	
B102001	P	P	G	605	TO 3	60	50	7.000A	45.000W	100J	.300G	2MA	40V	102	1.000A	
B102002	P	P	G	605	TO 3	50	40	7.000A	45.000W	100J	.300G	2MA	40V	102	1.000A	
B102003	P	P	G	605	TO 3	70	60	7.000A	45.000W	100J	.300G	2MA	50V	90	3.000A	
B103000	P	P	G	605	TO 3	70	60	10.000A	45.000W	100J	.300G	2MA	50V	90	3.000A	
B103001	P	P	G	605	TO 3	60	40	10.000A	45.000W	100J	.300G	2MA	50V	90	3.000A	
B103002	P	P	G	605	TO 3	70	50	10.000A	45.000W	100J	.300G	2MA	50V	90	3.000A	
B103003	P	P	G	605	TO 3	80	60	10.000A	45.000W	100J	.300G	2MA	50V	90	3.000A	
B103004	P	P	G	605	TO 3	90	70	10.000A	45.000W	100J	.300G	2MA	50V	90	3.000A	
B113000-BRN	P	P	G	605	TO 3	110	70	2.0	25.000A	70.000W	110J	.500G	100MA	60V	90	2.000A
B113000-ORG	P	P	G	605	TO 3	110	70	2.0	25.000A	70.000W	110J	.500G	100MA	60V	224	2.000A
B113001-BRN	P	P	G	605	TO 3	130	80	2.0	25.000A	70.000W	110J	.500G	100MA	80V	150	2.000A
B113001-ORG	P	P	G	605	TO 3	130	80	2.0	25.000A	70.000W	110J	.500G	100MA	80V	224	2.000A
B113002-BRN	P	P	G	605	TO 3	160	90	2.0	25.000A	70.000W	110J	.500G	100MA	100V	150	2.000A
B113002-ORG	P	P	G	605	TO 3	160	90	2.0	25.000A	70.000W	110J	.500G	100MA	100V	224	2.000A
B113003-BRN	P	P	G	605	TO 3	160	90	2.0	25.000A	70.000W	110J	.500G	10MA	80V	76	10.000A
B113003-ORG	P	P	G	605	TO 3	160	90	2.0	25.000A	70.000W	110J	.500G	10MA	90V	76	10.000A
B113004-BRN	P	P	G	605	TO 3	170	100	2.0	25.000A	70.000W	110J	.500G	10MA	100V	50	10.000A
B113004-ORG	P	P	G	605	TO 3	170	100	2.0	25.000A	70.000W	110J	.500G	10MA	100V	76	10.000A
B113005-BRN	P	P	G	211	TO 5	50	40	5.0	5.000A	5.000W	175J	HS SW	1MA	50V	80	1.000A
B113005-ORG	P	P	G	211	TO 5	50	40	5.0	5.000A	5.000W	175J	HS SW	1MA	50V	90	1.000A
B143001	N	S	BEN	211	TO 5	70	60	5.0	5.000A	5.000W	175J	HS SW	1MA	70V	80	1.000A
B143002	N	S	BEN	211	TO 5	70	60	5.0	5.000A	5.000W	175J	HS SW	1MA	70V	80	1.000A
B143003	N	S	BEN	211	TO 5	70	60	5.0	5.000A	5.000W	175J	HS SW	1MA	70V	90	1.000A
B143004	N	S	BEN	211	TO 5	90	80	5.0	5.000A	5.000W	175J	HS SW	1MA	70V	150	1.000A
B143005	N	S	BEN	211	TO 5	90	80	5.0	5.000A	5.000W	175J	HS SW	1MA	80V	90	1.000A
B143006	N	S	BEN	211	TO 5	90	80	5.0	5.000A	5.000W	175J	HS SW	1MA	90V	90	1.000A
B143007	N	S	BEN	211	TO 5	90	80	5.0	5.000A	5.000W	175J	HS SW	1MA	90V	150	1.000A
B143008	N	S	BEN	211	TO 5	50	40	5.0	5.000A	5.000W	175J	200.000G	1MA	50V		
B143009	N	S	BEN	211	TO 5	50	40	5.0	5.000A	5.000W	175J	200.000G	1MA	50V		
B143010	N	S	BEN	211	TO 5	70	60	5.0	5.000A	5.000W	175J	200.000G	1MA	70V		
B143011	N	S	BEN	211	TO 5	70	60	5.0	5.000A	5.000W	175J	200.000G	1MA	70V		
B143012	N	S	BEN	211	TO 5	70	60	5.0	5.000A	5.000W	175J	200.000G	1MA	90V		
B143013	N	S	BEN	211	TO 5	90	80	5.0	5.000A	5.000W	175J	200.000G	1MA	90V		
B143014	N	S	BEN	211	TO 5	90	80	5.0	5.000A	5.000W	175J	200.000G	1MA	90V		
B143015	N	S	BEN	541	541B	50	40	5.0	5.000A	5.000W	175J	HS SW	1MA	50V	90	1.000A
B143016	N	S	BEN	541	541B	50	40	5.0	5.000A	5.000W	175J	HS SW	1MA	50V	150	1.000A
B143017	N	S	BEN	541	541B	50	40	5.0	5.000A	5.000W	175J	HS SW	1MA	70V	80	1.000A
B143018	N	S	BEN	541	541B	70	60	5.0	5.000A	5.000W	175J	HS SW	1MA	70V	90	1.000A
B143019	N	S	BEN	541	541B	70	60	5.0	5.000A	5.000W	175J	HS SW	1MA	150V	150	1.000A
B143020	N	S	BEN	541	541B	70	60	5.0	5.000A	5.000W	175J	HS SW	1MA	90V	90	1.000A
B143021	N	S	BEN	541	541B	90	80	5.0	5.000A	5.000W	175J	HS SW	1MA	90V	150	1.000A
B143022	N	S	BEN	541	541B	90	80	5.0	5.000A	5.000W	175J	HS SW	1MA	90V	150	1.000A
B143023	N	S	BEN	541	541B	90	80	5.0	5.000A	5.000W	175J	200.000G	1MA	50V		
B143024	N	S	BEN	541	541B	90	80	5.0	5.000A	5.000W	175J	200.000G	1MA	70V		
B143025	N	S	BEN	541	541B	90	80	5.0	5.000A	5.000W	175J	200.000G	1MA	70V		
B143026	N	S	BEN	541	541B	90	80	5.0	5.000A	5.000W	175J	200.000G	1MA	90V		
B143027	N	S	BEN	541	541B	90	80	5.0	5.000A	5.000W	175J	200.000G	1MA	90V		
B143028	N	S	BEN	541	541B	90	80	5.0	5.000A	5.000W	175J	200.000G	1MA	90V		
B143																

Transistor Type No.	M G / P S	Manufacturer	Lead Ident	Out line	Maximum (V)			Maximum		Max. T (°C)	Frequency Res (MHz)	Leakage I _{ces} @ V _{ce}	Gain h _{FE} @ I _C
					V _{CE}	V _{BE}	V _{ES}	I _C	Power				
B145008	N S BEN		560	TO 61	90	80	5.0	10.000A	25.000W	175J			
B145009	N S BEN		560	TO 61	50	40	5.0	10.000A	25.000W	175J	200.000G	1MA 90V	150 1.000A
B145010	N S BEN		560	TO 61	50	40	5.0	10.000A	25.000W	175J		1MA 50V	
B145011	N S BEN		560	TO 61	70	60	5.0	10.000A	25.000W	175J	200.000G	1MA 50V	
B145012	N S BEN		560	TO 61	70	60	5.0	10.000A	25.000W	175J	200.000G	1MA 70V	
B145013	N S BEN		561	TO 61	90	80	5.0	10.000A	25.000W	175J	200.000G	1MA 70V	
B145014	N S BEN		561	TO 61	50	40	5.0	10.000A	25.000W	175J	200.000G	1MA 90V	
B146000	N S BEN		561	TO 61	90	80	5.0	10.000A	25.000W	175J	200.000G	1MA 90V	
B146001	N S BEN		561	TO 61	50	40	5.0	10.000A	25.000W	175J	HS SW	1MA 50V	80 1.000A
B146002	N S BEN		561	TO 61	50	40	5.0	10.000A	25.000W	175J	HS SW	1MA 50V	90 1.000A
B146003	N S BEN		561	TO 61	70	60	5.0	10.000A	25.000W	175J	HS SW	1MA 50V	150 1.000A
B146004	N S BEN		561	TO 61	70	60	5.0	10.000A	25.000W	175J	HS SW	1MA 90V	80 1.000A
B146005	N S BEN		561	TO 61	50	40	5.0	10.000A	25.000W	175J	HS SW	1MA 70V	90 1.000A
B146006	N S BEN		561	TO 61	70	60	5.0	10.000A	25.000W	175J	HS SW	1MA 70V	150 1.000A
B146007	N S BEN		561	TO 61	90	80	5.0	10.000A	25.000W	175J	HS SW	1MA 90V	80 1.000A
B146008	N S BEN		561	TO 61	90	80	5.0	10.000A	25.000W	175J	HS SW	1MA 90V	90 1.000A
B146009	N S BEN		561	TO 61	50	40	5.0	10.000A	25.000W	175J	HS SW	1MA 90V	150 1.000A
B146010	N S BEN		561	TO 61	50	40	5.0	10.000A	25.000W	175J	200.000G	1MA 50V	
B146011	N S BEN		561	TO 61	50	40	5.0	10.000A	25.000W	175J	200.000G	1MA 50V	
B146012	N S BEN		561	TO 61	70	60	5.0	10.000A	25.000W	175J	200.000G	1MA 70V	
B146013	N S BEN		561	TO 61	90	80	5.0	10.000A	25.000W	175J	200.000G	1MA 70V	
B146014	N S BEN		561	TO 61	90	80	5.0	10.000A	25.000W	175J	200.000G	1MA 90V	
B148000	N S BEN		561	TO 61	90	80	5.0	10.000A	25.000W	175J	200.000G	1MA 90V	
B148001	N S BEN		561	TO 61	100	80	7.0	20.000A	100.000W		60.000G	10UA 50V	30 10.000A
B148002	N S BEN		561	TO 61	120	100	7.0	20.000A	100.000W		60.000G	10UA 50V	30 10.000A
B148003	N S BEN		561	TO 61	100	80	7.0	15.000A	100.000W		60.000G	10UA 50V	23 15.000A
B148004	N S BEN		561	TO 61	120	100	7.0	15.000A	100.000W		60.000G	10UA 50V	23 15.000A
B148005	N S BEN	E ZN5412	561	TO 61	80	60	7.0	20.000A	100.000W		60.000G	10UA 50V	30 10.000A
B149000	N S BEN		540	TO 60	50	40	5.0	10.000A	25.000W	175J	200.000G	1MA 50V	
B149001	N S BEN		540	TO 60	50	40	5.0	10.000A	25.000W	175J	200.000G	1MA 50V	
B149002	N S BEN		540	TO 60	70	60	5.0	10.000A	25.000W	175J	200.000G	1MA 50V	
B149003	N S BEN		540	TO 60	70	60	5.0	10.000A	25.000W	175J	200.000G	1MA 70V	
B149004	N S BEN		540	TO 60	90	80	5.0	10.000A	25.000W	175J	200.000G	1MA 70V	
B149005	N S BEN		540	TO 60	90	80	5.0	10.000A	25.000W	175J	200.000G	1MA 90V	
B155000	N S BEN		560	TO 61	90	80	5.0	10.000A	25.000W	175J	200.000G	1MA 90V	
B155001	N S BEN		560	TO 61	120S	7.0	20.000A	60.000W	175J	60.000G	10UA 50V	80 2.000A	
B155002	N S BEN		560	TO 61	100S	7.0	15.000A	60.000W	175J	60.000G	10UA 50V	80 2.000A	
B155003	N S BEN		560	TO 61	80S	7.0	15.000A	60.000W	175J	60.000G	10UA 50V	80 2.000A	
B155004	N S BEN		560	TO 61	80S	7.0	15.000A	60.000W	175J	60.000G	10UA 50V	80 2.000A	
B155005	N S BEN		560	TO 61	80S	7.0	15.000A	60.000W	175J	60.000G	10UA 50V	80 2.000A	
B170000-BLK	N S BEN		605	TO 3	50	40	5.0	6.000A	60.000W	200J	1.000G	100A 40V	30 .500A
B170000-BRN	N S BEN		605	TO 3	50	40	5.0	6.000A	60.000W	200J	1.000G	100A 40V	30 .500A
B170000-ORG	N S BEN		605	TO 3	50	40	5.0	6.000A	60.000W	200J	1.000G	100A 40V	30 .500A
B170000-RED	N S BEN		605	TO 3	50	40	5.0	6.000A	60.000W	200J	1.000G	100A 40V	30 .500A
B170000-YEL	N S BEN		605	TO 3	50	40	5.0	6.000A	60.000W	200J	1.000G	100A 40V	30 .500A
B170001-BLK	N S BEN		605	TO 3	50	40	5.0	10.000A	90.000W	200J	1.000G	100A 40V	100 .500A
B170001-BRN	N S BEN		605	TO 3	50	40	5.0	10.000A	90.000W	200J	1.000G	100A 40V	100 .500A
B170001-ORG	N S BEN		605	TO 3	50	40	5.0	10.000A	90.000W	200J	1.000G	100A 40V	100 .500A
B170001-RED	N S BEN		605	TO 3	50	40	5.0	10.000A	90.000W	200J	1.000G	100A 40V	100 .500A
B170001-YEL	N S BEN		605	TO 3	50	40	5.0	10.000A	90.000W	200J	1.000G	100A 40V	100 .500A
B170002-BLK	N S BEN		605	TO 3	50	40	5.0	15.000A	120.000W	200J	1.000G	100A 40V	100 .500A
B170002-BRN	N S BEN		605	TO 3	50	40	5.0	15.000A	120.000W	200J	1.000G	100A 40V	100 .500A
B170002-ORG	N S BEN		605	TO 3	50	40	5.0	15.000A	120.000W	200J	1.000G	100A 40V	100 .500A
B170002-RED	N S BEN		605	TO 3	50	40	5.0	15.000A	120.000W	200J	1.000G	100A 40V	100 .500A
B170002-YEL	N S BEN		605	TO 3	50	40	5.0	15.000A	120.000W	200J	1.000G	100A 40V	100 .500A
B170003-BLK	N S BEN		605	TO 3	80	70	5.0	6.000A	60.000W	200J	1.000G	100A 40V	100 .500A
B170003-BRN	N S BEN		605	TO 3	80	70	5.0	6.000A	60.000W	200J	1.000G	100A 40V	100 .500A
B170003-ORG	N S BEN		605	TO 3	80	70	5.0	6.000A	60.000W	200J	1.000G	100A 40V	100 .500A
B170003-RED	N S BEN		605	TO 3	80	70	5.0	6.000A	60.000W	200J	1.000G	100A 40V	100 .500A
B170003-YEL	N S BEN		605	TO 3	80	70	5.0	6.000A	60.000W	200J	1.000G	100A 40V	100 .500A
B170004-BLK	N S BEN		605	TO 3	80	70	5.0	10.000A	90.000W	200J	1.000G	100A 40V	100 .500A
B170004-BRN	N S BEN		605	TO 3	80	70	5.0	10.000A	90.000W	200J	1.000G	100A 40V	100 .500A
B170004-ORG	N S BEN		605	TO 3	80	70	5.0	10.000A	90.000W	200J	1.000G	100A 40V	100 .500A
B170004-RED	N S BEN		605	TO 3	80	70	5.0	10.000A	90.000W	200J	1.000G	100A 40V	100 .500A
B170004-YEL	N S BEN		605	TO 3	80	70	5.0	10.000A	90.000W	200J	1.000G	100A 40V	100 .500A
B170005-BLK	N S BEN		605	TO 3	80	70	5.0	15.000A	120.000W	200J	1.000G	100A 40V	100 .500A
B170005-BRN	N S BEN		605	TO 3	80	70	5.0	15.000A	120.000W	200J	1.000G	100A 40V	100 .500A
B170005-ORG	N S BEN		605	TO 3	80	70	5.0	15.000A	120.000W	200J	1.000G	100A 40V	100 .500A
B170005-RED	N S BEN		605	TO 3	80	70	5.0	15.000A	120.000W	200J	1.000G	100A 40V	100 .500A
B170005-YEL	N S BEN		605	TO 3	80	70	5.0	15.000A	120.000W	200J	1.000G	100A 40V	100 .500A
B170006-BLK	N S BEN		605	TO 3	100	100	5.0	6.000A	60.000W	200J	1.000G	100A 40V	30 .500A
B170006-BRN	N S BEN		605	TO 3	100	100	5.0	6.000A	60.000W	200J	1.000G	100A 40V	30 .500A
B170006-ORG	N S BEN		605	TO 3	100	100	5.0	6.000A	60.000W	200J	1.000G	100A 40V	30 .500A
B170006-RED	N S BEN		605	TO 3	100	100	5.0	6.000A	60.000W	200J	1.000G	100A 40V	30 .500A
B170006-YEL	N S BEN		605	TO 3	100	100	5.0	6.000A	60.000W	200J	1.000G	100A 40V	30 .500A
B170007-BLK	N S BEN		605	TO 3	100	100	5.0	10.000A	90.000W	200J	1.000G	100A 40V	30 .500A
B170007-BRN	N S BEN		605	TO 3	100	100	5.0	10.000A	90.000W	200J	1.000G	100A 40V	30 .500A
B170007-ORG	N S BEN		605	TO 3	100	100	5.0	10.000A	90.000W	200J	1.000G	100A 40V	30 .500A
B170007-RED	N S BEN		605	TO 3	100	100	5.0	10.000A	90.000W	200J	1.000G	100A 40V	30 .500A
B170007-YEL	N S BEN		605	TO 3	100	100	5.0	10.000A	90.000W	200J	1.000G	100A 40V	30 .500A
B170008-BLK	N S BEN		605	TO 3	100	100	5.0	15.000A	120.000W	200J	1.000G	100A 40V	30 .500A
B170008-BRN	N S BEN		605	TO 3	100	100	5.0	15.000A	120.000W	200J	1.000G	100A 40V	30 .500A
B170008-ORG	N S BEN		605	TO 3	100	100	5.0	15.000A	120.000W	200J	1.000G	100A 40V	30 .500A
B170008-RED	N S BEN		605	TO 3	100	100	5.0	15.000A	120.000W	200J	1.000G	100A 40V	30 .500A
B170008-YEL	N S BEN		605	TO 3	100	100	5.0	15.000A	120.000W	200J	1.000G	100A 40V	30 .500A
B170009	N S BEN		605	TO 3	50	40	2.0	6.000A	60.000W	200J	1.000G	100A 40V	60 1.000A
B170010	N S BEN		605	TO 3	50	40	2.0	10.000A	90.000W	200J	1.000G	100A 40V	60 3.000A
B170011	N S BEN		605	TO 3	80	70	2.0	6.000A	60.000W	200J	1.000G	100A 40V	24 5.000A
B170012	N S BEN		605	TO 3	80	70	2.0	10.000A	90.000W	200J	1.000G	100A 40V	60 1.000A
B170013	N S BEN		605	TO 3	80	70	2.0	15.000A	120.000W	200J	1.000G	100A 40V	24 5.000A
B170014	N S BEN		605	TO 3	100	100	2.						

Transistor Type No.	N P	G S	Manufacturer	Lead Ident	Out line	Maximum (V)			Maximum I _c	Power	T (°C)	Frequency Resp (MHz)	Leakage I _{ceo} @ V _{ce}	Gain h _{fe} @ I _c
B176006	N	S	BEN	605	To 3	400	325	5.0	5.000A	50.000W	175		250UA 125V	30 1.500A
B176007	N	S	BEN	605	To 3	400	325	5.0	5.000A	50.000W	175		250UA 125V	20 2.500A
B176008	N	S	BEN	605	To 3	550	325	5.0	5.000A	50.000W	175		250UA 125V	50 1.00A
B176009	N	S	BEN	605	To 3	550	325	5.0	5.000A	50.000W	175		250UA 125V	40 500A
B176010	N	S	BEN	605	To 3	550	325	5.0	5.000A	50.000W	175		250UA 125V	30 1.500A
B176011	N	S	BEN	605	To 3	550	325	5.0	5.000A	50.000W	175		250UA 125V	20 2.500A
B176012	N	S	BEN	605	To 3	700	325	5.0	5.000A	50.000W	175		250UA 125V	50 1.00A
B176013	N	S	BEN	605	To 3	700	325	5.0	5.000A	50.000W	175		250UA 125V	40 500A
B176014	N	S	BEN	605	To 3	700	325	5.0	5.000A	50.000W	175		250UA 125V	30 1.500A
B176015	N	S	BEN	605	To 3	700	325	5.0	5.000A	50.000W	175		250UA 125V	20 2.500A
B176024	N	S	BEN	605	To 3	400	325	5.0	5.000A	50.000W	175		250UA 125V	30 1.500A
B176025	N	S	BEN	605	To 3	400	325	5.0	5.000A	50.000W	175		250UA 125V	20 2.500A
B176026	N	S	BEN	605	To 3	550	325	5.0	5.000A	50.000W	175		250UA 125V	30 1.500A
B176027	N	S	BEN	605	To 3	700	325	5.0	5.000A	50.000W	175		250UA 125V	20 2.500A
B176028	N	S	BEN	605	To 3	550	325	5.0	5.000A	50.000W	175		250UA 125V	30 1.500A
B176029	N	S	BEN	605	To 3	700	325	5.0	5.000A	50.000W	175		250UA 125V	20 2.500A
B176030	N	S	BEN	605	To 3	700	325	5.0	5.000A	50.000W	175		250UA 125V	30 1.500A
B177000	N	S	BEN	605	To 3	800	500	5.0	5.000A	125.000W	200		5MA 100V	30 10.000A
BC107	N	S	IMG	211	To 18	45	45	5.0	1.00A	300W	175	0.020E	1NA 20V	25C .002A
BC107A	N	S	IMG	211	To 18	50	45	5.0	1.00A	300W	175	250.000G	15NA 30V	18V .002A
BC107B	N	S	IMG	211	To 18	50	45	5.0	1.00A	300W	175	250.000G	15NA 30V	36V .002A
BC108	N	S	IMG	211	To 18	30	20	5.0	1.00A	300W	175	250.000G	15NA 30V	18V .002A
BC108A	N	S	IMG	211	To 18	30	20	5.0	1.00A	300W	175	250.000G	15NA 30V	36V .002A
BC108B	N	S	IMG	211	To 18	30	20	5.0	1.00A	300W	175	250.000G	15NA 30V	67V .002A
BC108C	N	S	IMG	211	To 18	30	20	5.0	1.00A	300W	175	250.000G	15NA 30V	18V .002A
BC109	N	S	IMG	211	To 18	30	20	5.0	1.00A	300W	175	250.000G	15NA 30V	67V .002A
BC109B	N	S	IMG	211	To 18	30	20	5.0	1.00A	300W	175	250.000G	15NA 30V	36V .002A
BC109C	N	S	IMG	211	To 18	30	20	5.0	1.00A	300W	175	250.000G	15NA 30V	18V .002A
BC110	N	S	IMG	210	To 18	80	80	8.0	1.00A	300W	175	100.000G	100NA 80V	3C .002A
BC121	N	S	IMG	47	47A	5	5	5.0	0.75A	250W	150	50.000G	10NA 15V	30V .001A
BC122	N	S	IMG	47	47A	30	20	5.0	0.75A	250W	150	50.000G	10NA 25V	20V .001A
BC123	N	S	IMG	47	47A	45	30	5.0	0.75A	250W	150	50.000G	10NA 25V	20V .001A
BC129	N	S	IMG	210	To 18	45	45	5.0	1.00A	175W	150	300.000G	1NA 20V	25C .002A
BC130	N	S	IMG	210	To 18	20	20	5.0	1.00A	175W	150	300.000G	1NA 20V	25C .002A
BC131	N	S	IMG	210	To 18	20	20	5.0	1.00A	175W	150	300.000G	1NA 20V	25C .002A
BC140	N	S	IMG	210	To 18	80	40	7.0	1.00A	750W	175	50.000G	100NA 60V	10V .150A
BC140-06	N	S	IMG	211	To 39	80	40	7.0	1.00A	750W	175	50.000G	100NA 40V	6V .100A
BC140-10	N	S	IMG	211	To 39	80	40	7.0	1.00A	750W	175	50.000G	100NA 40V	10V .100A
BC140-16	N	S	IMG	211	To 39	80	40	7.0	1.00A	750W	175	50.000G	100NA 40V	16V .100A
BC141	N	S	IMG	210	To 39	100	60	7.0	1.00A	750W	175	50.000G	100NA 60V	6V .100A
BC141-06	N	S	IMG	211	To 39	100	60	7.0	1.00A	750W	175	50.000G	100NA 60V	10V .100A
BC141-10	N	S	IMG	211	To 39	100	60	7.0	1.00A	750W	175	50.000G	100NA 60V	15V .100A
BC141-16	N	S	IMG	211	To 39	100	60	7.0	1.00A	750W	175	50.000G	100NA 60V	16V .100A
BC147	N	S	IMG	985	985A	50S	6.0	1.00A	220W	125	250.000G	15UA 30V	16V .002A	
BC148	N	S	IMG	985	985A	30S	5.0	1.00A	220W	125	250.000G	15UA 30V	20V .002A	
BC149	N	S	IMG	985	985A	30S	5.0	1.00A	220W	125	300.000G	15UA 30V	46V .002A	
BC157	N	S	IMG	985	985A	50S	5.0	1.00A	220W	125	130.000G	100NA 20V	14V .002A	
BC158	N	S	IMG	985	985A	30S	5.0	1.00A	220W	125	130.000G	100NA 20V	20V .002A	
BC159	N	S	IMG	985	985A	25S	5.0	1.00A	220W	125	130.000G	100NA 20V	20V .002A	
BC160-06	N	S	IMG	211	To 39	40	40	5.0	1.00A	750W	175	50.000G	100NA 40V	6V .100A
BC160-10	N	S	IMG	211	To 39	40	40	5.0	1.00A	750W	175	50.000G	100NA 40V	10V .100A
BC160-16	N	S	IMG	211	To 39	40	40	5.0	1.00A	750W	175	50.000G	100NA 40V	16V .100A
BC161-06	N	S	IMG	211	To 39	60	60	5.0	1.00A	750W	175	50.000G	100NA 60V	6V .100A
BC161-10	N	S	IMG	211	To 39	60	60	5.0	1.00A	750W	175	50.000G	100NA 60V	10V .100A
BC161-16	N	S	IMG	211	To 39	60	60	5.0	1.00A	750W	175	50.000G	100NA 60V	16V .100A
BC169	N	S	IMG	43	To 92	30S	6.0	1.00A	220W	125	250.000G	15UA 50V	25V .002A	
BC169B	N	S	IMG	43	To 92	30S	5.0	1.00A	220W	125	250.000G	15UA 50V	35V .002A	
BC169C	N	S	IMG	43	To 92	30S	5.0	1.00A	220W	125	300.000G	15UA 50V	45V .002A	
BC170A	N	S	IMG	40	To 92	20	20	5.0	1.00A	300W	125	100.000G	100NA 15V	60V .001A
BC170B	N	S	IMG	40	To 92	20	20	5.0	1.00A	300W	125	100.000G	100NA 15V	60V .001A
BC170C	N	S	IMG	40	To 92	20	20	5.0	1.00A	300W	125	100.000G	100NA 15V	60V .001A
BC171A	N	S	IMG	40	To 92	50	45	5.0	1.00A	300W	125	250.000G	15NA 50V	22V .002A
BC171B	N	S	IMG	40	To 92	50	45	5.0	1.00A	300W	125	250.000G	15NA 50V	22V .002A
BC172A	N	S	IMG	40	To 92	30	20	5.0	1.00A	300W	125	250.000G	15NA 30V	22V .002A
BC172B	N	S	IMG	40	To 92	30	20	5.0	1.00A	300W	125	250.000G	15NA 30V	22V .002A
BC172C	N	S	IMG	40	To 92	30	20	5.0	1.00A	300W	125	250.000G	15NA 30V	22V .002A
BC173B	N	S	IMG	40	To 92	30	20	5.0	1.00A	300W	125	250.000G	15NA 30V	22V .002A
BC173C	N	S	IMG	40	To 92	30	20	5.0	1.00A	300W	125	250.000G	15NA 30V	22V .002A
BC174A	N	S	IMG	40	To 92	64	50	1.00A	300W	125	200.000G	15NA 60V	22V .020A	
BC174B	N	S	IMG	40	To 92	70	64	5.0	1.00A	300W	125	200.000G	15NA 60V	22V .020A
BC177	N	S	IMG	210	To 18	50S	5.0	1.00A	300W	175	130.000G	100NA 20V	10V .002A	
BC178	N	S	IMG	210	To 18	20	20	5.0	1.00A	300W	175	130.000G	100NA 20V	20V .002A
BC179	N	S	IMG	211	To 18	25	25	5.0	500A	400W	200	100.000G	100NA 20V	12V .050A
BC192	N	S	IMG	47	47A	5	5	5.0	0.75A	250W	150	80.000G	100NA 2V	17V .001A
BC202	N	S	IMG	47	47A	30	20	5.0	0.75A	250W	150	80.000G	100NA 15V	11V .001A
BC203	N	S	IMG	47	47A	45	30	5.0	0.75A	250W	150	80.000G	100NA 25V	11V .001A
BC250A	N	S	IMG	40	To 92	20	20	5.0	1.00A	300W	125	180.000G	100NA 15V	44V .001A
BC250B	N	S	IMG	40	To 92	20	20	5.0	1.00A	300W	125	180.000G	100NA 15V	44V .001A
BC250C	N	S	IMG	40	To 92	20	20	5.0	1.00A	300W	125	180.000G	100NA 15V	44V .001A
BC251A	N	S	IMG	40	To 92	45	45	5.0	1.00A	300W	125	200.000G	50NA 45V	40V .020A
BC251B	N	S	IMG	40	To 92	45	45	5.0	1.00A	300W	125	200.000G	50NA 45V	40V .020A
BC251C	N	S	IMG	40	To 92	45	45	5.0	1.00A	300W	125	200.000G	50NA 45V	40V .020A
BC252A	N	S	IMG	40	To 92	20	20	5.0	1.00A	300W	125	200.000G	50NA 20V	40V .020A
BC252B	N	S	IMG	40	To 92	20	20	5.0	1.00A	300W	125	200.000G	50NA 20V	40V .020A
BC252C	N	S	IMG	40	To 92	20	20	5.0	1.00A	300W	125	200.000G	50NA 20V	40V .020A
BC253A	N	S	IMG	40	To 92	20	20	5.0	1.00A	300W	125	200.000G	50NA 20V	6V .001A
BC253B	N	S	IMG	40	To 92	20	20	5.0	1.00A	300W	125	200.000G	50NA 20V	6V .001A
BC253C	N	S	IMG	40	To 92	20	20	5.0	1.00A	300W	125	200.000G	50NA 20V	6V .001A
BC256A	N	S	IMG	40	To 92	64	64	5.0	1.00A	300W	125	200.000G	50NA 64V	20V .020A
BC256B	N	S	IMG	40	To 92	64	64	5.0	1.00A	300W	125	200.000G	50NA 64V	20V .020A
BC257	N	S	IMG	43	To 92	30S	5.0	1.00A	220W	125	130.000G	100NA 20V	14V .002A	
BC258	N	S												

Transistor Type No.	N P S	E S	Manufacturer	Lead Ident	Out- line	Maximum (V)			Maximum		Max. T. ^o C	Frequency Resp.(MHz)	Leakage		Gain	
						V _{CE}	V _{BE}	V _{ES}	I _C	Power			I _{CEO}	V _{CE}	I _{CE}	h _{FE}
BC340-10	N	S	IMG	211	TO 39	40	40	5.0	.500A	.800W	200J		100NA	40V	103	.050A
BC340-16	N	S	IMG	211	TO 39	40	40	5.0	.500A	.800W	200J		100NA	40V	162	.050A
BC341-06	N	S	IMG	211	TO 39	60	60	5.0	.500A	.800W	200J		100NA	60V	65	.050A
BC341-10	N	S	IMG	211	TO 39	60	60	5.0	.500A	.800W	200J		100NA	60V	103	.050A
BC360-06	N	S	IMG	211	TO 39	40	40	5.0	.500A	.800W	200J		100NA	40V	65	.050A
BC360-10	N	S	IMG	211	TO 39	40	40	5.0	.500A	.800W	200J		100NA	40V	103	.050A
BC361-06	N	S	IMG	211	TO 39	60	60	5.0	.500A	.800W	200J		100NA	40V	162	.050A
BC361-10	N	S	IMG	211	TO 39	60	60	5.0	.500A	.800W	200J		100NA	40V	103	.050A
BC1274			SEE 2N2294													
BC1274A			SEE 2N2295													
BC1274B			SEE 2N2296													
BCY10	P	S	RAD,AMP	60	60A	32	32	12.0	.250A	.300W	150J	1.500B	100NA	6V	24	.030A
BCY11	P	S	RAD,AMP	60	60A	60	60	12.0	.500A	.300W	150J	1.500B	100NA	6V	24	.030A
BCY12	P	S	RAD,AMP	60	60A	32	32	12.0	.500A	.300W	150J	2.000B	100NA	6V	40	.030A
BCY30	P	S	RAD,AMP	210	TO 5	64	64	45.0	.100A	.250W	150J	.250B	100NA	6V	25	.001A
BCY31	P	S	RAD,AMP	210	TO 5	32	32	16.0	.100A	.250W	150J	.250B	100NA	6V	40	.001A
BCY33	P	S	RAD,AMP	210	TO 5	32	32	16.0	.100A	.250W	150J	.600B	100NA	6V	40	.001A
BCY34	P	S	RAD,AMP	210	TO 18	32	32	16.0	.200A	1.000W	200J	300.000G	100A	32V	300	.032A
BCY58	N	S	SIH	211	TO 18	32	32	5.0	.100A	.300W	175J	300.000G	10NA	32V	225	.020A
BCY58A	N	S	IMG	211	TO 18	32	32	5.0	.100A	.300W	175J	300.000G	10NA	32V	280	.020A
BCY58B	N	S	IMG	211	TO 18	32	32	5.0	.100A	.300W	175J	300.000G	10NA	32V	350	.020A
BCY58C	N	S	IMG	211	TO 18	32	32	5.0	.100A	.300W	175J	300.000G	10NA	32V	400	.020A
BCY58D	N	S	IMG	211	TO 18	32	32	5.0	.100A	.300W	175J	300.000G	10NA	32V	300	.020A
BCY59	N	S	SIH	210	TO 18	45	45	7.0	.200A	1.000W	200J	300.000G	10A	45V	300	.045A
BCY59A	N	S	IMG	211	TO 18	45	45	5.0	.100A	.300W	175J	300.000G	10NA	45V	225	.020A
BCY59B	N	S	IMG	211	TO 18	45	45	5.0	.100A	.300W	175J	300.000G	10NA	45V	280	.020A
BCY59C	N	S	IMG	211	TO 18	45	45	5.0	.100A	.300W	175J	300.000G	10NA	45V	350	.020A
BCY59D	N	S	IMG	211	TO 18	45	45	5.0	.100A	.300W	175J	300.000G	10NA	45V	540	.020A
BCY65	N	S	SIH	210	TO 18	45	60	7.0	.200A	1.000W	200J	300.000G	10A	60V	300	.060A
BCY66	N	S	SIH	210	TO 18	45	45	7.0	.200A	1.000W	200J	300.000G	10A	45V	290	.045A
BCY78	P	S	SIH	210	TO 18	45	5.0	7.0	.200A	.300W	175J	200.000G	10A	45V	250	.002A
BCZ10	P	S	RAD,AMP	60	60A	25	25	20.0	.050A	.250W	150J	1.000B	100NA	10V	20	.001A
BCZ11	P	S	RAD,AMP	60	60A	25	25	20.0	.050A	.250W	150J	3.000B	100NA	10V	35	.001A
BCZ12	P	S	RAD,AMP	60	60A	60	60	30.0	.050A	.250W	150J	1.000B	100NA	10V	15	.001A
BCZ13	P	S	RAD	105	105B	20	20		.010A	.080W	125J				20	
BCZ14	P	S	RAD	105	105B	20	20		.010A	.080W	125J				20	
BD106A	N	S	IMG	605	605A	36	36	5.0	2.500A	11.500W	175J	100.000G	500NA	32V	88	500A
BD106B	N	S	IMG	605	605A	36	36	5.0	2.500A	11.500W	175J	100.000G	500NA	32V	175	500A
BD107A	N	S	IMG	605	605A	64	64	5.0	2.500A	11.500W	175J	100.000G	500NA	60V	88	500A
BD107B	N	S	IMG	605	605A	64	64	5.0	2.500A	11.500W	175J	100.000G	500NA	60V	175	500A
BD109	N	S	SIH	605	605A	60	40	5.0	1.000A	5.000W	200J	30.000G	100NA	40V	105	1.000A
BD130	N	S	SIH	605	TD 3	100	60	7.0	15.000A	100.000W	200J	.700G	500NA	100V	40	4.000A
BDY10	N	S	RAD	605	TO 3	50	50		4.000A	150.000W	175J	.500B			24	
BDY11	N	S	RAD	605	TO 3	80	80		4.000A	150.000W	175J	.500B			24	
BDY12	N	S	SIH	605	605A	80S	5.0		4.000A	26.000W	175J	30.000G	100NA	40V	105	1.000A
BDY13	N	S	SIH	605	605A	80S	5.0		2.000A	26.000W	175J	30.000G	100NA	60V	115	1.000A
BDY15A	N	S	IMG	605	605A	36	36	5.0	2.500A	11.500W	175J	100.000G	100NA	32V	88	500A
BDY15B	N	S	IMG	605	605A	36	36	5.0	2.500A	11.500W	175J	100.000G	100NA	32V	175	500A
BDY15C	N	S	IMG	605	605A	36	36	5.0	2.500A	11.500W	175J	100.000G	100NA	32V	350	500A
BDY16A	N	S	IMG	605	605A	64	64	5.0	2.500A	11.500W	175J	100.000G	100NA	60V	88	500A
BDY16B	N	S	IMG	605	605A	64	64	5.0	2.500A	11.500W	175J	100.000G	100NA	60V	175	500A
BDY23A	N	S	SES	605	TO 3	60	60	10.0	6.000A	85.000W	200J	10.000G	1MA	60V	30	2.000A
BDY23B	N	S	SES	605	TO 3	60	60	10.0	6.000A	85.000W	200J	10.000G	1MA	60V	60	2.000A
BDY23C	N	S	SES	605	TO 3	100	90	10.0	6.000A	85.000W	200J	10.000G	1MA	60V	120	2.000A
BDY24A	N	S	SES	605	TO 3	100	90	10.0	6.000A	85.000W	200J	10.000G	1MA	90V	60	2.000A
BDY24B	N	S	SES	605	TO 3	100	90	10.0	6.000A	85.000W	200J	10.000G	1MA	90V	120	2.000A
BDY24C	N	S	SES	605	TO 3	200	140	10.0	6.000A	85.000W	200J	10.000G	1MA	120V	30	2.000A
BDY24D	N	S	SES	605	TO 3	200	140	10.0	6.000A	85.000W	200J	10.000G	1MA	120V	60	2.000A
BDY25A	N	S	SES	605	TO 3	300	180	10.0	6.000A	85.000W	200J	10.000G	1MA	180V	30	2.000A
BDY25B	N	S	SES	605	TO 3	300	180	10.0	6.000A	85.000W	200J	10.000G	1MA	180V	60	2.000A
BDY25C	N	S	SES	605	TO 3	400	200	10.0	6.000A	85.000W	200J	10.000G	1MA	200V	30	2.000A
BDY25D	N	S	SES	605	TO 3	400	200	10.0	6.000A	85.000W	200J	10.000G	1MA	200V	60	2.000A
BDY26A	N	S	SES	605	TO 3	500	250	10.0	6.000A	85.000W	200J	10.000G	1MA	250V	30	2.000A
BDY26B	N	S	SES	605	TO 3	500	250	10.0	6.000A	85.000W	200J	10.000G	1MA	250V	60	2.000A
BDY26C	N	S	SES	605	TO 3	500	250	10.0	6.000A	85.000W	200J	10.000G	1MA	250V	120	2.000A
BDY27A	N	S	SES	605	TO 3	150	150S	5.0	.040A	2.500W	175J	150.000G	100NA	140V	30	.010A
BDY27B	N	S	SES	211	TO 39	200S	5.0		.080A	3.000W	175J	120.000G	200NA	100V	30	.060A
BDY27C	N	S	SES	210	TO 18	150	145R	5.0	.040A	2.600W	175J	80.000G	100NA	100V	30	.010A
BDY28A	N	S	TFK	211	TO 39	50	30	4.0	.030A	.145W	175J	230.000G	500NA	10V	80	.001A
BDY28B	N	S	TFK, SIH	211	TO 39	140	140	5.0	.100A	1.270W	175J	80.000G	10NA	60V	38	.030A
BDY28C	N	S	TFK, SIH	211	TO 39	250	250R	5.0	.100A	5.000W	175J	110.000G	50NA	200V	38	.030A
BF110	N	S	IMG	211	TO 39	160R	5.0		.100A	5.000W	175J	110.000G	50NA	100V	38	.030A
BF111	N	S	TFK, SIH	230	230A	30			.025A	.330W	125J	100.000G				
BF112	N	S	IMG	230	230A	30			.030A	.330W	125J	35.000G				
BF113	N	S	IMG	230	230A	30			.030A	.330W	125J	100.000G				
BF114	N	S	TFK, SES, SIH	230	230A	30			.025A	.330W	125J	35.000G				
BF115	N	S	TFK, SIH	218	TD 72	40	30	4.0	.025A	.130W	175J	330.000G			57	.004A
BF116	N	S	SIH	218	TD 72	50	30	4.0	.025A	.260W	175J	550.000G	300NA	20V	100	.007A
BF117	N	S	SIH	211	TO 39	100S	5.0		.040A	.600W	175J	120.000G			88	.007A
BF118	N	S	SIH	211	TO 39	160S	5.0		.050A	1.700W	175J	120.000G			30	.015A
BF119	N	S	SIH	211	TO 39	160S	5.0		.050A	1.700W	175J	120.000G			30	.020A
BF179A	N	S	SIH	211	TO 39	220S	5.0		.050A	1.700W	175J	120.000G			30	.020A
BF179B	N	S	SIH	218	TD 72	30	20	5.0	.050A	1.700W	175J	120.000G			30	.020A
BF179C	N	S	SIH	218	TD 72	30	20	5.0	.030A	.145W	175J	220.000G			115	.001A
BF185	N	S	SIH	218	TD 72	30	20	5.0	.030A	.220W	125J	260.000G			67	.001A
BF194	N	S	SIH	985	985A	30	20	5.0	.030A	.220W	125J	200.000G			67	.001A
BF195	N	S	SIH	218	TD 72</											

Transistor Type No.	M P	G S	Manufacturer	Lead Type	Out- line	Maximum (V)			Maximum		Max. T _c (°C)	Frequency Resp.(MHz)	Leakage I _{cs} @ V _{cs}	Gain h _{fe} @ I _c	
						V _{cs}	V _{ce}	V _{es}	I _c	Power					
BFY45	N	S	SIH	210	TO 39	140S	5.0	.030A	2.500W	200J	130.000G	100NA 140V	60	.010A	
BFY46	N	S	SIH	210	TO 39	75	30	7.0	.500A	2.600W	200J	70.000G	10NA 60V	175	.150A
BFY50	N	S	IMG	211	TO 39	80	35	6.0	1.000A	2.800W	200J	100.000G	50NA 60V	30	.150A
BFY51	N	S	IMG	211	TO 39	60	30	6.0	1.000A	2.800W	200J	110.000G	50NA 40V	45	.150A
BFY52	N	S	IMG	211	TO 39	40	20	6.0	1.000A	2.800W	200J	120.000G	50NA 30V	45	.150A
BFY65	N	S	IMG	210	TO 5	100	90R	7.0	.050A	.565W	175J	50.000G	50NA 75V	30	.002A
BFY66			SEE 2N918												
BFY69A	N	S	TFK	8	BA	25	18	5.0	.060W	.060W	150J	20.000G	50NA 18V	50	.010A
BFY69B	N	S	TFK	8	BA	25	18	5.0	.060W	.060W	150J	20.000G	50NA 18V	50	.010A
BFY80	N	S	TFK	210	TO 18	100	90R	7.0	.050A	.260W	175J	50.000G	50NA 75V	30	.002A
BR100A	N	S	SEE 2N5527												
BR100B	N	S	BEN	541	541B	60	40	3.0	5.000A	7.500W	200J	500.000G	100UA 30V	100	3.000A
BR100C	N	S	SEE 2N5528												
BR100D	N	S	BEN	540	TO 60	60	40	3.0	10.000A	35.000W	200J	500.000G	100UA 30V	100	3.000A
BR100E	N	S	SEE 2N5529												
BR100F	N	S	SEE 2N5530												
BR101A	N	S	SEE 2N5531												
BR101B	N	S	BEN	541	541B	90	70	3.0	5.000A	7.500W	200J	500.000G	100UA 30V	68	3.000A
BR101C	N	S	SEE 2N5532												
BR101D	N	S	BEN	540	TO 60	90	70	3.0	10.000A	35.000W	200J	500.000G	100UA 30V	68	3.000A
BR101E	N	S	SEE 2N5533												
BR101F	N	S	SEE 2N5534												
BR200A	N	S	SEE 2N5535												
BR200B	N	S	SEE 2N5536												
BR201A	N	S	SEE 2N5537												
BR201B	N	S	SEE 2N5538												
BR300A	N	S	BEN	561	TO 61	60	50		25.000A	50.000W				90	10.000A
BR300B	N	S	BEN	560	TO 61	60	50		25.000A	50.000W				90	10.000A
BR301A	N	S	BEN	561	TO 61	90	75		25.000A	50.000W				90	10.000A
BR301B	N	S	BEN	560	TO 61	90	75		25.000A	50.000W				90	10.000A
BR400A	N	S	BEN	561	TO 61	60	50		25.000A	50.000W				90	5.000A
BR400B	N	S	BEN	560	TO 61	60	50		25.000A	50.000W				90	5.000A
BR401A	N	S	BEN	561	TO 61	90	75		25.000A	50.000W				90	5.000A
BR401B	N	S	BEN	560	TO 61	90	75		25.000A	50.000W				90	5.000A
BSC-1015	N	S	BEN	412	TO 82	30		10.0	.750A	15.000W	150J	.020E		20	
BSC-1015A	N	S	BEN	412	TO 82	60		10.0	.750A	15.000W	150J	.020E		20	
BSC-1015B	N	S	BEN	412	TO 82	100		10.0	.750A	15.000W	150J	.020E		20	
BSC-1016	N	S	BEN	412	TO 82	30		10.0	.750A	15.000W	150J	.020E		20	
BSC-1016A	N	S	BEN	412	TO 82	60		10.0	.750A	15.000W	150J	.020E		20	
BSC-1016B	N	S	BEN	412	TO 82	100		10.0	.750A	15.000W	150J	.020E		20	
BSW72	P	S	IMG	211	TO 18	40	25	5.0	5.00A	4.00W	200J	200.000G	100NA 30V	70	.150A
BSW73	P	S	IMG	211	TO 18	40	25	5.0	5.00A	4.00W	200J	200.000G	100NA 30V	175	.150A
BSW74	P	S	IMG	211	TO 18	75	40	5.0	5.00A	4.00W	200J	200.000G	10NA 50V	70	.150A
BSW75	P	S	IMG	211	TO 18	75	40	5.0	5.00A	4.00W	200J	200.000G	10NA 50V	175	.150A
BSW82	N	S	IMG	211	TO 18	40	25	5.0	5.00A	5.00W	175J	250.000G	10NA 30V	70	.100A
BSW83	N	S	IMG	211	TO 18	40	25	5.0	5.00A	5.00W	175J	250.000G	100NA 30V	175	.100A
BSW84	N	S	IMG	211	TO 18	75	40	5.0	5.00A	5.00W	175J	250.000G	10NA 50V	70	.100A
BSW85	N	S	IMG	211	TO 18	75	40	5.0	5.00A	5.00W	175J	250.000G	10NA 50V	175	.100A
BSX22	N	S	IMG	211	TO 39	40	32	5.0	1.500A	6.000W	175J	100.000G	1UA 10V	53	.500A
BSX23	N	S	IMG	211	TO 39	90	65	5.0	1.500A	6.000W	175J	100.000G	1UA 30V	53	.500A
BSX25	N	S	TFK	210	TO 18	40	25	5.0	1.500A	3.20W	200J	50.000G	50NA 30V	30	.100A
BSX38	N	S	TFK	210	TO 18	35	30	5.0	200A	.175W	150J	200.000G	50NA 25V	65	.010A
BSX40	P	S	IMG	211	TO 39	30	30	5.0	5.00A	.800W	200J	100.000G	25NA 25V	70	.150A
BSX41	P	S	IMG	211	TO 39	30	30	5.0	5.00A	.800W	200J	150.000G	25NA 25V	175	.150A
BSX43	N	S	SIH	211	TO 39	40	25	7.0	1.000A	5.000W	200J	60.000G	10NA 60V	70	.150A
BSX46	N	S	SIH	211	TO 39	30	30	5.0	5.00A	.800W	200J	100.000G	25NA 25V	175	.150A
BSX48	N	S	SIH	210	TO 18	50	25	5.0	.600A	1.000W	200J	400.000G	120NA 50V	42	.100A
BSX49	N	S	SIH	210	TO 18	60	40	5.0	.600A	1.000W	200J	400.000G	70NA 50V	42	.100A
BSX62	N	S	SIH	211	TO 39	60S	5.0		2.000A	4.400W	200J	30.000G	100NA 40V	105	1.000A
BSX63	N	S	SIH	211	TO 39	80S	5.0		2.000A	4.400W	200J	30.000G	100NA 40V	65	1.000A
BSY10	N	S	RAO	210	TO 5	60	60		.050A	.300W	175J	60.000B		90	
BSY11	N	S	RAO	210	TO 5	60	60		.050A	.300W	175J	50.000B		120	
BSY17	N	S	SIH	210	TO 18	20	12	5.0	.200A	1.000W	200J	280.000G	1UA 20V	35	.010A
BSY18	N	S	SIH	210	TO 18	20	12	5.0	.200A	1.000W	200J	280.000G	1UA 20V	70	.010A
BSY19			SEE 2N708												
BSY21			SEE 2N914												
BSY34	N	S	SIH	210	TO 39	60	40	5.0	.600A	2.600W	200J	250.000G	70NA 50V	42	.100A
BSY44			SEE 2N1613												
BSY45			SEE 2N1893												
BSY46			SEE 2N2193												
BSY51	N	S	IMG	211	TO 39	60	25	5.0	.500A	.800W	200J	100.000G	100NA 30V	70	.150A
BSY52	N	S	IMG	211	TO 39	60	25	5.0	.500A	.800W	200J	100.000G	100NA 30V	175	.150A
BSY53	N	S	IMG	211	TO 39	75	30	7.0	.750A	.800W	200J	100.000G	10NA 60V	70	.150A
BSY54	N	S	IMG	211	TO 39	75	30	7.0	.750A	.800W	200J	100.000G	10NA 60V	175	.150A
BSY55	N	S	IMG	211	TO 39	120	80	7.0	.500A	.800W	200J	100.000G	10NA 90V	70	.150A
BSY56	N	S	IMG	211	TO 39	120	80	7.0	.500A	.800W	200J	100.000G	10NA 90V	175	.150A
BSY58	N	S	SIH	210	TO 39	50	25	5.0	.600A	2.600W	200J	250.000G	120NA 50V	42	.100A
BSY61	N	S	SIH	43	TO 92	25	15	5.0	2.00A	2.00W	125J	200.000G	500NA 15V	105	.010A
BSY62	N	S	SIH	210	TO 18	25	15	5.0	.200A	1.000W	200J	200.000G	500NA 15V	95	.010A
BSY63	N	S	SIH	210	TO 18	40	15	5.0	.200A	1.000W	200J	300.000G	25NA 20V	60	.010A
BSY70			SEE 2N706												
BSY71			SEE 2N1711												
BSY72	N	S	IMG	211	TO 18	25	18	5.0	.100A	.300W	175J	170.000G	100NA 20V	142	.001A
BSY73	N	S	IMG	211	TO 18	25	18	5.0	.100A	.300W	175J	145.000G	100NA 20V	60	.001A
BSY74	N	S	IMG	211	TO 18	25	18	5.0	.100A	.300W	175J	170.000G	100NA 20V	142	.001A
BSY75	N	S	IMG	211	TO 18	40	32	5.0	.100A	.300W	175J	145.000G	50NA 32V	60	.001A
BSY76	N	S	IMG	211	TO 18	40	32	5.0	.100A	.300W	175J	170.000G	50NA 32V	142	.001A
BSY77	N	S	IMG	211	TO 18	80	64	5.0	.100A	.300W	175J	145.000G	50NA 65V	60	.001A
BSY78	N	S	IMG	211	TO 18	80	64	5.0	.100A	.300W	175J	170.000G	50NA 65V	142	.001A
BSY79	N	S	IMG	211	TO 18	120		5.0	.030A	.300W	175J	50.000G	50NA 90V	45	.001A
BSY80	N	S	IMG	211	TO 18	25	18	5.0	.100A	.300W	175J	210.000G	100NA 20V	300	.001A
BSY81	N	S	IMG	211	TO 39	40	18	5.0	1.000A	5.000W	200J	100.000G	100NA 30V	70	.150A
BSY82	N	S	IMG	211	TO 39	40	18	5.0	1.000A	5.000W	200J	120.000G	100NA 30V	175	.150A
BSY83	N	S	IMG	211	TO 39	80	35	7.0	1.000A	5.000W	200J	100.000G	10NA 60V	70	.150A
BSY84	N	S	IMG	211	TO 39	80	35	7.0	1.000A	5.000W	200J	120.000G	10NA 60V	175	.150A
BSY85	N	S	IMG	211	TO 39	120	64	7.0	1.000A	5.000W	200J	110.000G	10NA 30V	70	.150A
BSY86	N	S	IMG	211	TO 39	12									

Transistor Type No.	M P S	G /	S	Manufacturer	Lead Ident	Out- line	Maximum (V)			Maximum		Max. T.(°C)	Frequency Resp.(MHz)	Leakage I _{sat} @ V _{CE}	Gain h _{FE} @ I _C		
							V _{CE}	V _{CE(sat)}	V _{BE}	I _C	Power						
CDT1311	-P	G	CLE		605	TO 3	60	40	30.0	5.000A	45.000W	95J	.003E	2MA	30V	80	
CDT1312	-P	G	CLE		605	TO 3	80	50	30.0	5.000A	45.000W	95J	.003E	2MA	40V	80	
CDT1313	-P	G	CLE		605	TO 3	100	60	30.0	5.000A	45.000W	95J	.003E	2MA	50V	80	
CDT1319	-P	G	CLE		605	TO 3	40	25	30.0	5.000A	45.000W	95J	.003E	2MA	20V	40	
COT1320	-P	G	CLE		605	TO 3	60	40	30.0	5.000A	45.000W	95J	.003E	2MA	30V	40	
COT1321	-P	G	CLE		605	TO 3	80	50	30.0	5.000A	45.000W	95J	.003E	2MA	40V	40	
COT1322	-P	G	CLE		605	TO 3	100	60	30.0	5.000A	45.000W	95J	.003E	2MA	50V	40	
CK4	-P	G	RAY		110	110A	25	24	12.0	1.00A	.080W	85J	40.000B	5UA	12V	60	
CK4A	-P	G	RAY		110	110B	25	24	12.0	1.00A	.080W	85J	40.000B	5UA	12V	60	
CK13	-P	G	RAY		110	110A	18	18		2.00A	.150W	85J	3.000B	2UA	12V	25	
CK14	-P	G	RAY		110	110A	15	15	12.0	2.00A	.150W	85J	5.000B	2UA	12V	60	
CK16	-P	G	RAY		110	110A	12	12		2.00A	.150W	85J	10.000B	2UA	12V	80	
CK17	-P	G	RAY		110	110A	10	10		2.00A	.150W	85J	20.000B	2UA	12V	140	
CK22	-P	G	RAY		110	110A	35	20	12.0	1.00A	.080W	85J	1.200B	6UA	20V	90	
CK22A	-P	G	RAY		110	110B	35	20	12.0	1.00A	.080W	85J	1.200B	6UA	20V	90	
CK22B	-P	G	RAY		295	295A	35	20	12.0	1.00A	.080W	85J	1.200B	6UA	20V	90	
CK22C	-P	G	RAY		315	315A	35	20	12.0	1.00A	.080W	85J	1.200B	6UA	20V	90	
CK25	-P	G	RAY		110	110A	20	20		4.00A	.150W	85J	4.000B	4UA	2V	30	
CK26	-P	G	RAY		110	110A	18	18		4.00A	.150W	85J	6.000B	4UA	2V	40	
CK27	-P	G	RAY		110	110A	15	15		4.00A	.150W	85J	11.000B	4UA	2V	55	
CK28	-P	G	RAY		110	110A	30	12	20.0	4.00A	.080W	85J	10.000B	4UA	2V	80	
CK28A	-P	G	RAY		110	110B	30	12	20.0	4.00A	.080W	85J	10.000B	4UA	2V	80	
CK64	-P	G	RAY		110	110A	45	29	12.0	4.00A	.080W	85J	8.000B	5UA	20V	24	
CK65	-P	G	RAY		110	110A	45	30	12.0	4.00A	.080W	85J	1.000B	5UA	20V	44	
CK65A	-P	G	RAY		110	110B	45	30	12.0	4.00A	.080W	85J	1.000B	5UA	20V	44	
CK66	-P	G	RAY		110	110A	35	20	12.0	4.00A	.080W	85J	1.000B	5UA	20V	44	
CK66A	-P	G	RAY		110	110B	35	20	12.0	4.00A	.080W	85J	1.000B	5UA	20V	44	
CK67	-P	G	RAY		110	110A	35	15	12.0	4.00A	.080W	85J	1.500B	5UA	20V	180	
CK256	-P	G	RAY		100	100B	30	15	30.0	3.000A	20.000W	85J	.004E	1MA	30V	50	
CK258	-P	G	RAY		100	100B	60	30	60.0	3.000A	20.000W	85J	.004E	1MA	60V	42	
CK311	-P	G	RAY		426	TO 13	80	80R	60.0	3.000A	20.000W	85J	.004E	5MA	80V	42	
CK312	-P	G	RAY		426	TO 13	100	100R	60.0	3.000A	20.000W	85J	.004E	5MA	120V	42	
CK313	-P	G	RAY		426	TO 13	120	120R	60.0	3.000A	20.000W	85J	.004E	5MA	120V	42	
CK314	-P	G	RAY		426	TO 13	150	150R	60.0	3.000A	20.000W	85J	.004E	5MA	150V	42	
CK315	-P	G	RAY		426	TO 13	200	200R	60.0	3.000A	20.000W	85J	.004E	5MA	200V	42	
CK398	-N	S	RAY		210	TO 5	120	120S	6.0	.050A	.250W	175J	10.000B	500NA	30V	40	
CK419	-N	S	RAY		210	TO 5	50	40	5.0	.050A	.250W	160J	10.000B	100NA	30V	18	
CK420	-N	S	RAY		210	TO 5	50	50	50.0	.050A	.250W	160J	10.000B	100NA	30V	300	
CK421	-N	S	RAY		210	TO 5	50	50	50.0	.050A	.250W	160J	10.000B	100NA	30V	360	
CK422	-N	S	RAY		210	TO 5	50	55	5.0	.050A	.250W	160J	10.000B	100NA	30V	25	
CK474	-N	S	RAY		210	TO 5	50	40	5.0	.050A	.250W	160J	10.000B	1UA	30V	15	
CK475	-N	S	RAY		210	TO 5	50	35	5.0	.050A	.250W	160J	10.000B	1UA	30V	60	
CK476	-N	S	RAY		210	TO 5	50	30	5.0	.050A	.250W	160J	10.000B	1UA	30V	25	
CK477	-N	S	RAY		210	TO 5	50	30	5.0	.050A	.250W	160J	10.000B	1UA	30V	25	
CK721	-P	G	RAY		5	5C	15	15		.010A	.180W	85J	.800B	6UA	20V	22	
CK722	-P	G	RAY		5	5C	24	12		.010A	.200W	75A	1.200B	6UA	20V	50	
CK725	-P	G	RAY		5	5C	24	12		.010A	.200W	75A	1.200B	6UA	20V	50	
CK727	-P	G	RAY		5	5C	6			.010A	.080W	70A	.800B	12UA	2V	50	
CK751	-P	G	RAY		5	5C	20	9		1.00A	.240W	85J	1.200B	6UA	20V	40	
CK754	-P	G	RAY		5	5C	10	10		1.00A	.100W	85J	1.200B	5UA	20V	300	
CK758			SEE 2N111														
CK760			SEE 2N112														
CK761			SEE 2N113														
CK762			SEE 2N114														
CK766			SEE 2N211														
CK768	-P	G	RAY		10	10A	15	15		.100A	.150W	85J	2.500B	1UA	12V	20	
CK790	-P	S	RAY		10	10A	45		22.0	.050A	.200W	135A	2.00B	200NA	20V	15	
CK791	-P	S	RAY		10	10A	30		22.0	.050A	.200W	135A	2.00B	200NA	20V	24	
CK793	-P	S	RAY		10	10A	30		22.0	.050A	.200W	135A	2.00B	200NA	20V	20	
CK870	-P	G	RAY		5	5A	5	20	22.0	1.50A	130W	85J	5.00B	6UA	20V	20	
CK871	-P	G	RAY		5	5A	15	15		1.50A	130W	85J	6.00B	6UA	20V	20	
CK882	-P	G	RAY		10	10A	24	24		1.00A	.150W	85J	1.000B	6UA	20V	90	
CK888	-P	G	RAY		10	10A	12	12		1.00A	.150W	85J	1.400B	6UA	20V	140	
CK942			SEE 2N1623														
CTP1111	-P	G	CLE		605	TO 3	80	60S	45.0		45.000W	95J	.004E	5MA	80V	45	
CTP1117	-P	G	CLE		605	TO 3	40		10.0		40.000W	90J	.300B	2MA	40V	100	
CTP1133	-P	G	CLE		605	TO 3	40	40S	6.0		40.000W	90J	.015E	4MA	40V	60	
CTP1135	-P	G	CLE		605	TO 3	40	40S	20.0		40.000W	90J	1.000G	4MA	40V	80	
CTP1136	-P	G	CLE		605	TO 3	60	60S	20.0		40.000W	90J	1.000G	4MA	60V	80	
CTP1500	-P	G	CLE		607	TO 41	100	65	30.0	15.000A	75.000W	95J	.003E	500UA	2V	50	
CTP1503	-P	G	CLE		605	TO 3	80	55	30.0	15.000A	75.000W	95J	.003E	500UA	2V	50	
CTP1504	-P	G	CLE		605	TO 3	60	40	30.0	15.000A	75.000W	95J	.003E	500UA	2V	50	
CTP1508	-P	G	CLE		605	TO 3	40	25	30.0	15.000A	75.000W	95J	.003E	500UA	2V	50	
CTP1544	-P	G	CLE		605	TO 3	60	30	30.0	25.000A	75.000W	95J	.002E	4MA	60V	76	
CTP1545	-P	G	CLE		605	TO 3	80	40	30.0	25.000A	75.000W	95J	.002E	4MA	80V	76	
CTP1552	-P	G	CLE		605	TO 3	40	20	30.0	25.000A	75.000W	95J	.002E	4MA	40V	76	
CTP1553	-P	G	CLE		605	TO 3	100	50	30.0	25.000A	75.000W	95J	.002E	4MA	100V	76	
CTP3500	-P	G	CLE		607	TO 41	100	65	30.0	15.000A	75.000W	95J	.003E	500UA	2V	50	
CTP3503	-P	G	CLE		607	TO 41	80	55	30.0	15.000A	75.000W	95J	.003E	500UA	2V	50	
CTP3504	-P	G	CLE		607	TO 41	60	40	30.0	15.000A	75.000W	95J	.003E	500UA	2V	50	
CTP3508	-P	G	CLE		607	TO 41	40	25	30.0	15.000A	75.000W	95J	.003E	500UA	2V	50	
CTP3544	-P	G	CLE		607	TO 41	60	30	30.0	25.000A	75.000W	95J	.002E	4MA	60V	76	
CTP3545	-P	G	CLE		607	TO 41	80	40	30.0	25.000A	75.000W	95J	.002E	4MA	80V	76	
CTP3552	-P	G	CLE		607	TO 41	40	20	30.0	25.000A	75.000W	95J	.002E	4MA	40V	76	
CTP3553	-P	G	CLE		607	TO 41	100	50	30.0	25.000A	75.000W	95J	.002E	4MA	100V	76	
06C	N	S	GEC		561	TO 63	150	80	15.0	30.000A	150.000W	175J	1.5SSW	10NA	150V	40	30.000A
016G6	N	S	GEC		45	TO 98	30	12	3.0	.025A	.200W	100J	500.000G	500NA	30V	30	.005A
016K4	N	S	GEC		45	TO 98	30	30	4.0	.025A	.200W	100J	580.000G	500NA	20V	110	.005A
D24A3391	-N	S	GEC		927	927A	25	25	5.0	1.00A	.200W	100J	120.000G	100NA	25V	376	.002A
D24A3391A	-N	S	GEC		927	927A	25	25	5.0	1.00A	.200W	100J	120.000G	100NA	25V	376	.002A
D24A3392	-N	S	GEC		927	927A	25	25	5.0	1.00A	.200W	100J	140.000G	100NA	25V	226	.002A
D24																	

Transistor Type No.	N C P	S	Manufacturer	Lead Ident	Out- line	Maximum (V)			Maximum		Max. T.(°C)	Frequency Resp.(MHz)	Leakage I _{sat} @ V _{CE}	Gain h _{FE} @ I _C
						V _{CE}	V _{ES}	V _{EB}	I _C	Power				
D27C3			SEE D42C2											
D27C4			SEE D42C1											
D27D1			SEE D43C5											
D27D2			SEE D43C4											
D27D3			SEE D43C2											
D27D4			SEE D43C1											
D28A05	N	S	GEC	52	52A	35	25	5.0	500A	1.000W	150J	10.000G	100NA 35V	136 @ 0.02A
D28A06	N	S	GEC	52	52A	35	25	5.0	500A	1.000W	150J	10.000G	100NA 35V	314 @ 0.02A
D28A12	N	S	GEC	52	52A	50	50	5.0	500A	1.000W	150J	10.000G	100NA 50V	134 @ 0.02A
D28A13	N	S	GEC	52	52A	50	50	5.0	500A	1.000W	150J	10.000G	100NA 50V	314 @ 0.02A
D28E	N	S	SEE D40D											
D28E	N	S	SEE D40N											
D29A04	N	S	GEC SPR	45	T0 98	35	25	4.0	500A	.330W	125J	140.000G	100NA 35V	7 @ 0.050A
D29A05	N	S	GEC SPR	45	T0 98	35	25	4.0	500A	.330W	125J	140.000G	100NA 35V	176 @ 0.050A
D29A06	N	S	GEC SPR	45	T0 98	35	25	4.0	500A	.330W	125J	140.000G	100NA 35V	376 @ 0.050A
D29A07	N	S	GEC	45	T0 98	50	40	4.0	500A	.330W	125J	140.000G	100NA 50V	79 @ 0.050A
D29A08	N	S	GEC	45	T0 98	50	40	4.0	500A	.330W	125J	140.000G	100NA 50V	376 @ 0.050A
D29A09	N	S	GEC	45	T0 98	50	40	4.0	500A	.330W	125J	140.000G	100NA 50V	376 @ 0.050A
D29A10	N	S	GEC	45	T0 98	60	60	5.0	500A	.330W	125J	140.000G	50NA 60V	70 @ 0.050A
D29A11	N	S	GEC	45	T0 98	60	60	5.0	500A	.330W	125J	140.000G	50NA 60V	176 @ 0.050A
D29A12	N	S	GEC	45	T0 98	35	25	4.0	500A	.330W	125J	140.000G	100NA 35V	96 @ 0.02A
D29E01	P	P	GEC	45	T0 98	35	25	4.0	500A	.330W	125J	140.000G	100NA 35V	165 @ 0.02A
D29E01J1	P	P	GEC	45	45B	35	25	5.0	.750A	.700W	135J	100.000G	100NA 25V	105 @ 0.02A
D29E02	P	P	GEC	45	T0 98	35	25	5.0	.750A	.500W	135J	135.000G	100NA 25V	262 @ 0.02A
D29E02J1	P	P	GEC	45	45B	35	25	5.0	.750A	.700W	135J	135.000G	100NA 25V	262 @ 0.02A
D29E04	P	P	GEC	45	T0 98	50	40	5.0	.750A	.500W	135J	100.000G	100NA 25V	90 @ 0.02A
D29E04J1	P	P	GEC	45	45B	50	40	5.0	.750A	.500W	135J	100.000G	100NA 25V	150 @ 0.02A
D29E05	P	P	GEC	45	T0 98	50	40	5.0	.750A	.500W	135J	125.000G	100NA 25V	150 @ 0.02A
D29E05J1	P	P	GEC	45	45B	50	40	5.0	.750A	.700W	135J	120.000G	100NA 25V	150 @ 0.02A
D29E06	P	P	GEC	45	T0 98	50	40	5.0	.750A	.500W	135J	135.000G	100NA 25V	235 @ 0.02A
D29E06J1	P	P	GEC	45	45B	50	40	5.0	.750A	.700W	135J	135.000G	100NA 25V	235 @ 0.02A
D29E07	P	P	GEC	45	T0 98	50	40	5.0	.750A	.500W	135J	150.000G	100NA 25V	375 @ 0.02A
D29E07J1	P	P	GEC	45	45B	50	40	5.0	.750A	.700W	135J	150.000G	100NA 25V	375 @ 0.02A
D29E08	P	P	GEC	45	T0 98	70	60	5.0	.750A	.500W	135J	80.000G	100NA 25V	60 @ 0.02A
D29E08J1	P	P	GEC	45	45B	70	60	5.0	.750A	.500W	135J	80.000G	100NA 25V	90 @ 0.02A
D29E09	P	P	GEC	45	T0 98	70	60	5.0	.750A	.500W	135J	100.000G	100NA 25V	90 @ 0.02A
D29E09J1	P	P	GEC	45	45B	70	60	5.0	.750A	.700W	135J	100.000G	100NA 25V	90 @ 0.02A
D29E10	P	P	GEC	45	T0 98	70	60	5.0	.750A	.500W	135J	120.000G	100NA 25V	150 @ 0.02A
D29E10J1	P	P	GEC	45	45B	70	60	5.0	.750A	.700W	135J	120.000G	100NA 25V	150 @ 0.02A
D30A1	P	S	GEC	132	132A	18	18	4.0	.090W	100J			25NA 18V	52 @ 0.10A
D30A2	P	S	GEC	132	132A	18	18	4.0	.090W	100J			25NA 18V	104 @ 0.10A
D30A3	P	S	GEC	132	132A	18	18	4.0	.090W	100J			25NA 18V	200 @ 0.10A
D31B			SEE D41D											
D33D21	N	S	GEC	45	T0 98	35	25	5.0	.750A	.500W	135J	100.000G	100NA 25V	105 @ 0.02A
D33D21J1	N	S	GEC	45	45B	35	25	5.0	.750A	.500W	135J	100.000G	100NA 25V	.05 @ 0.02A
D33D22	N	S	GEC	45	T0 98	35	25	5.0	.750A	.500W	135J	135.000G	100NA 25V	262 @ 0.02A
D33D22J1	N	S	GEC	45	45B	35	25	5.0	.750A	.700W	135J	135.000G	100NA 25V	262 @ 0.02A
D33D24	N	S	GEC	45	T0 98	50	40K		.750A	.500W	135J	100.000G	100NA 25V	90 @ 0.02A
D33D24J1	N	S	GEC	45	45B	50	40K		.750A	.700W	135J	100.000G	100NA 25V	90 @ 0.02A
D33D25	N	S	GEC	45	T0 98	50	40K		.750A	.500W	135J	120.000G	100NA 25V	150 @ 0.02A
D33D25J1	N	S	GEC	45	45B	50	40	5.0	.750A	.700W	135J	120.000G	100NA 25V	150 @ 0.02A
D33D26	N	S	GEC	45	T0 98	50	40K		.750A	.500W	135J	135.000G	100NA 25V	225 @ 0.02A
D33D26J1	N	S	GEC	45	45B	50	40	5.0	.750A	.700W	135J	135.000G	100NA 25V	225 @ 0.02A
D33D27	N	S	GEC	45	T0 98	50	40K		.750A	.500W	135J	150.000G	100NA 25V	375 @ 0.02A
D33D27J1	N	S	GEC	45	45B	50	40	5.0	.750A	.700W	135J	150.000G	100NA 25V	375 @ 0.02A
D33D28	N	S	GEC	45	T0 98	70	60	5.0	.750A	.500W	135J	80.000G	100NA 25V	60 @ 0.02A
D33D28J1	N	S	GEC	45	45B	70	60	5.0	.750A	.700W	135J	80.000G	100NA 25V	60 @ 0.02A
D33D29	N	S	GEC	45	T0 98	70	60	5.0	.750A	.500W	135J	100.000G	100NA 25V	90 @ 0.02A
D33D29J1	N	S	GEC	45	45B	70	60	5.0	.750A	.700W	135J	100.000G	100NA 25V	90 @ 0.02A
D33D30	N	S	GEC	45	T0 98	70	70	5.0	.750A	.500W	135J	120.000G	100NA 25V	150 @ 0.02A
D33D30J1	N	S	GEC	45	45B	70	60	5.0	.750A	.700W	135J	120.000G	100NA 25V	150 @ 0.02A
D40D1	N	S	GEC	52	52A	45S	5.0		1.000A	6.000W	150C	200.000G	100NA 45V	88 @ 1.00A
D40D2	N	S	GEC	52	52A	45S	5.0		1.000A	6.000W	150C	200.000G	100NA 45V	210 @ 1.00A
D40D3	N	S	GEC	52	52A	45S	5.0		1.000A	6.000W	150C	200.000G	100NA 45V	440 @ 1.00A
D40D4	N	S	GEC	52	52A	60S	5.0		1.000A	6.000W	150C	200.000G	100NA 60V	88 @ 1.00A
D40D5	N	S	GEC	52	52A	60S	5.0		1.000A	6.000W	150C	200.000G	100NA 60V	210 @ 1.00A
D40D7	N	S	GEC	52	52A	75S	5.0		1.000A	6.000W	150C	200.000G	100NA 75V	210 @ 1.00A
D40D8	N	S	GEC	52	52A	75S	5.0		1.000A	6.000W	150C	200.000G	100NA 75V	88 @ 1.00A
D40N1	N	S	GEC	52	52A	250R	5.0		1.00A	6.250W	150C	50.000G	10UA 250V	60 @ 0.020A
D40N3	N	S	GEC	52	52A	300R	5.0		1.00A	6.250W	150C	50.000G	10UA 300V	60 @ 0.020A
D41D1	P	S	GEC	52	52A	45S	5.0		1.000A	6.000W	150C	150.000G	100NA 45V	88 @ 1.00A
D41D2	P	S	GEC	52	52A	45S	5.0		1.000A	6.000W	150C	150.000G	100NA 45V	195 @ 1.00A
D41D4	P	S	GEC	52	52A	60S	5.0		1.000A	6.000W	150C	150.000G	100NA 60V	88 @ 1.00A
D41D5	P	S	GEC	52	52A	60S	5.0		1.000A	6.000W	150C	150.000G	100NA 60V	210 @ 1.00A
D41D7	P	S	GEC	52	52A	75S	5.0		1.000A	6.000W	150C	150.000G	100NA 75V	88 @ 1.00A
D41D8	P	S	GEC	52	52A	75S	5.0		1.000A	6.000W	150C	150.000G	100NA 75V	210 @ 1.00A
D42C1	N	S	GEC	52	52A	45S	5.0		3.000A	12.500W	150J	50.000G	10UA 45V	70 @ 2.00A
D42C2	N	S	GEC	52	52A	45S	5.0		3.000A	12.500W	150J	50.000G	10UA 45V	70 @ 2.00A
D42C3	N	S	GEC	52	52A	45S	5.0		3.000A	12.500W	150J	50.000G	10UA 45V	70 @ 2.00A
D42C4	N	S	GEC	52	52A	60S	5.0		3.000A	12.500W	150J	50.000G	10UA 60V	38 @ 2.00A
D42C5	N	S	GEC	52	52A	60S	5.0		3.000A	12.500W	150J	50.000G	10UA 60V	70 @ 2.00A
D42C6	N	S	GEC	52	52A	75S	5.0		3.000A	12.500W	150J	50.000G	10UA 75V	38 @ 2.00A
D42C7	N	S	GEC	52	52A	75S	5.0							

Transistor Type No.	H / P /	G /	S	Manufacturer	Lead Ident	Out- line	Maximum (V)			Maximum I _c	Maximum Power	Max. T. _c (°C)	Frequency Resp.(MHz)	Leakage I _{c, sat} @ V _{CE}	Gain h _{FE} @ I _c	
							V _{CE}	V _{CE}	V _{CE}							
DTG110A	P	G	DEL		605	TO 3	110X	2.8	25.000A			8.50G	20MA 110V	125	1.000A	
DTG110B	P	G	DEL		605	TO 3	90X	2.0	25.000A			8.50G	20MA 90V	140	1.000A	
DTG600	P	G	DEL		605	TO 3	75	5.0	1.0	25.000A		8.50G	20MA 75V	75	5.000A	
DTG601	P	G	DEL		605	TO 3	75	6.0	1.0	25.000A		8.50G	20MA 75V	75	5.000A	
DTG602	P	G	DEL		605	TO 3	90	7.0	1.0	25.000A		8.50G	20MA 90V	75	5.000A	
DTG603	P	G	DEL		605	TO 3	90	8.0	1.0	25.000A		8.50G	20MA 90V	75	5.000A	
DTG603M	P	G	OEL		605	TO 3	90X	4.4	15.000A			8.50G	20MA 90V	112	5.000A	
DTG1010	P	G	DEL		605	TO 3	325X	1.0	15.000A			2.50G	10MA 325V			
DTG1110	P	G	DEL		605	TO 3	200X	1.0	15.000A			4.50G	15MA 200V			
DTG1200	P	G	DEL		605	TO 3	120	1.0	15.000A			3.50G	10MA 120V	34	8.000A	
DTG2000	P	G	DEL		605	TO 3	400	60X	1.0	25.000A		3.50G	10MA 60V	37	8.000A	
DTG2100	P	G	DEL		605	TO 3	80X	1.0	25.000A			3.50G	10MA 80V	37	8.000A	
DTG2200	P	G	DEL		605	TO 3	100X	1.0	25.000A			3.50G	10MA 100V	37	8.000A	
DTG2300	P	G	DEL		605	TO 3	120X	1.0	25.000A			3.50G	10MA 120V	37	8.000A	
DTG2400	P	G	DEL		605	TO 3	140X	1.0	25.000A			3.50G	10MA 140V	37	8.000A	
DTG2400M	P	G	DEL		605	TO 3	140X	1.5	25.000A			3.50G	10MA 140V	55	10.000A	
DTS103	N	S	DEL		605	TO 3	80X	5.0	2.000A	125.000W	150J	4.000G	500UA 80V	34	5.000A	
DTS104	N	S	OEL		605	TO 3	80X	5.0	15.000A	125.000W	150J	4.000G	500UA 80V	80	5.000A	
DTS105	N	S	DEL		605	TO 3	100X	5.0	15.000A	125.000W	150J	4.000G	500UA 100V	34	5.000A	
DTS106	N	S	DEL		605	TO 3	110X	5.0	15.000A	125.000W	150J	4.000G	500UA 110V	34	5.000A	
DTS107	N	S	DEL		605	TO 3	120X	5.0	15.000A	125.000W	150J	4.000G	500UA 120V	34	5.000A	
DTS401	N	S	DEL		605	TO 3	400	5.0	5.000A			4.000G	500UA 400V	45	5.000A	
DTS402	N	S	OEL		605	TO 3	400	5.0	5.000A			4.000G	500UA 400V			
DTS410	N	S	BEN		605	TO 3	200	200	5.0	3.500A	80.000W	150J	4.000G	250UA 200V	52	1.000A
DTS411	N	S	DEL		605	TO 3	300	300	5.0	3.500A	100.000W	150J	5.000G	500UA 300V	52	1.000A
DTS412	N	S	DEL		605	TO 3	400	400	5.0	3.500A	100.000W	150J	5.000G	500UA 400V	40	1.000A
DTS423	N	S	DEL	BEN	605	TO 3	400	400	5.0	3.500A	100.000W	150J	3.000G	250UA 400V	50	1.000A
DTS423M	N	S	DEL		605	TO 3	400	400	5.0	3.500A	100.000W	150J	3.000G	250UA 400V	50	1.000A
OTS424	N	S	DEL		605	TO 3	500	5.0	3.500A			4.000G	250UA 500V	52	1.000A	
DTS425	N	S	DEL		605	TO 3	500	5.0	3.500A			4.000G	250UA 500V	52	1.000A	
DTS430	N	S	DEL		605	TO 3	400	400	5.0	5.000A		150J	4.000G	3MA 400V	26	2.500A
DTS431	N	S	DEL		605	TO 3	400	400	5.0	5.000A		150J	4.000G	3MA 400V	26	2.500A
DTS431M	N	S	DEL		605	TO 3	400	5.0	5.000A			4.000G	3MA 400V	24	2.500A	
ECG100	P	G	SVL		210	TO 5	25	20R	20.0	.300A	.150W		5.000B		40	
ECG101	P	G	SVL		210	TO 5	25	20R	20.0	.300A	.150W		5.000B		40	
ECG102	M	P	SVL		210	TO 5	30	16R	20.0	.250A	.150W		2.000B		30	
ECG103	P	G	SVL		210	TO 5	30	16R	20.0	.250A	.150W		2.000B		30	
ECG104	P	G	SVL		605	TO 3	50	35R	20.0	5.000A	90.000W		.010B		90	
ECG105	P	G	SVL		405	TO 36	50	35R	20.0	15.000A	100.000W		.010B		90	
ECG106	P	G	SVL		210	TO 18	35	15	1.0	.075A	.250W		500.000G		30	
ECG107	P	N	SVL		43	TO 92	35	15	1.0	.075A	.250W		110.000G		30	
ECG108	N	S	SVL		170	170F	35	15	5	.075A	.250W		800.000G		15	
ECG121	P	G	SVL		605	TO 3	65	45R	15.0	5.000A	90.000W		.022B		80	
ECG123	N	S	SVL		211	TO 5	40	20	5.0	.500A	.500W		50.000G		180	
ECG124	N	S	SVL		210	TO 6	30	30R	2.0	.400A	10.000W		10.000G		140	
ECG126	N	P	SVL		105	TO 24	25	25	2.0	200A	.200W		250.000G		80	
ECG127	P	G	SVL		605	TO 3	350	350S	2.0	10.000A	56.000W		1.000G		23	
ECG128	N	S	SVL		210	TO 5	110	80	7.0	1.000A	1.000W		120.000G		90	
ECG129	P	N	SVL		210	TO 5	110	80	7.0	1.000A	1.000W		120.000G		90	
ECG130	N	S	SVL		210	TO 5	110	80	7.0	1.000A	1.000W		120.000G		90	
ECG131	N	P	SVL		605	TO 66	32	20	10.0	3.000A	6.000W		1.000G		110	
ECG152	N	S	SVL		53	53A	60	60	5.0	3.000A	40.000W		3.000G		60	
ECG153	N	S	SVL		53	53A	60	60	5.0	3.000A	40.000W		3.000G		60	
ECG154	N	S	SVL		211	TO 39	300	300	7.0	7.000A	7.000W		40.000G		100	
ECG155	N	G	SVL		605	TO 66	32	20	10.0	3.000A	6.000W		1.000G		110	
EN10	N	S	SEM		210	TO 18	25	15	4.0	.100A	.100W		100.000G		350	
EN30	N	S	SEM		210	TO 18	20	20	4.0	.300A	.300W		300.000G		350	
EN40	N	S	SEM		41	TO 92	30	20	4.0	.300A	.300W		300.000G		350	
EN697	N	S	FSC		173	TO105	25	15	3.0	.200W	125J	50.000G	1UA 30V	70	.150A	
EN706	N	S	FSC		173	TO106	25	15	3.0	.200W	125J	300.000G	1MA 15V	60	.010A	
EN708	N	S	FSC		173	TO106	40	15	5.0	.200W	125J	300.000G	50NA 20V	60	.010A	
EN718A	N	S	FSC		173	TO106	75	40	7.0	.220W	125J	60.000G	50NA 60V	70	.150A	
EN722	N	S	SEE	2N4354	173	TO106	100	60	7.0	.200W	125J	50.000G	100NA 75V	70	.150A	
EN750	N	S	FSC		173	TO106	100	60	7.0	.200W	125J	60.000G	100NA 75V	175	.150A	
EN871	N	S	FSC		173	TO106	60	15	5.0	.200W	125J	300.000G	100NA 20V	60	.010A	
EN914	N	S	FSC		173	TO106	40	15	5.0	.200W	125J	250.000G	50NA 60V	100	.010A	
EN915	N	S	FSC		173	TO106	70	50	5.0	.200W	125J	300.000G	50NA 30V	100	.010A	
EN916	N	S	FSC		173	TO106	45	25	5.0	.200W	125J	600.000G	50NA 15V	40	.003A	
EN918	N	S	FSC		173	TO106	30	15	10.0	.050A	.200W	125J	300.000G	50NA 45V	175	.001A
EN930	N	S	FSC		173	TO106	45	45	5.0	.030A	.200W	125J	30.000G	50NA 45V	175	.001A
EN956	N	S	FSC		173	TO106	75	40	7.0	.220W	125J	60.000G	50NA 60V	175	.150A	
EN1132	N	S	SEE	2N4354	173	TO105	75	40	7.0	.300W	125J	60.000G	50NA 60V	100	.150A	
EN1613	N	S	FSC		173	TO105	75	40	7.0	.300W	125J	60.000G	50NA 60V	100	.150A	
EN1711	N	S	FSC		173	TO105	60	30	5.0	.800A	.350W	250.000G	50NA 50V	175	.150A	
EN2219	N	S	FSC		173	TO106	60	30	5.0	.800A	.200W	250.000G	50NA 50V	175	.150A	
EN2222	N	S	FSC		173	TO106	60	30	5.0	.800A	.200W	250.000G	50NA 50V	175	.150A	
EN2484	N	S	FSC		173	TO106	60	60	6.0	.050A	.200W	125J	30.000G	50NA 45V	225	.001A
EN2894A	P	S	FSC		173	TO106	12	12	4.5	.600A	.200W	125J	800.000G	50NA 10V	55	.100A
EN2905	P	S	FSC		173	TO106	60	40	5.0	.600A	.200W	125J	150.000G	50NA 50V	175	.150A
EN2907	P	S	FSC		173	TO106	60	40	5.0	.600A	.200W	125J	150.000G	50NA 50V	175	.150A
EN3009	N	S	FSC		173	TO106	40	15	4.0	.200W	125J	350.000G	500NA 20V	60	.030A	
EN3013	N	S	FSC		173	TO106	40	15	5.0	.200W	125J	350.000G	300NA 20V	60	.030A	
EN3014	N	S	FSC		173	TO106	20	20	5.0	.200W	125J	350.000G	300NA 20V	60	.030A	
EN3250	N	S	FSC		173	TO106	40	40	5.0	.100A	.200W	125J	250.000G	10NA 45V	88	.010A
EN3502	P	S	FSC		173	TO105	45	45	5.0	.600A	.300W	125J	150.000G	10NA 30V	175	.150A
EN3504	P	S	FSC		173	TO106	45	45	5.0	.600A	.200W	125J	150.000G	10NA 30V	175	.150A
EN3962	P	S	FSC		173	TO106	60	60	6.0	.060A	.200W	125J	40.000G	50NA 50V	260	.050A
EP25	P	S	SEM		210	TO 18	25	15	4.0	.100A	.100W		100.000G		350	
EP25	P	S	SEM		210	TO 18	30	20	4.0	.300A	.300W		300.000G		350	
EP35	P	S	SEM		41	TO 92	30	20	4.0	.300A	.300W		300.000G		350	
ES310	P	G	EBA		105	105A	30	15		.010A	.054W	65J	.300B	6UA 10V	12	
ES3111	P	G	EBA		105	105A	30	15		.010A	.054W	65J	.400B	6UA 10V	18	

Transistor Type No.	N P S	C S	Manufacturer	Lead Ident	Out- line	Maximum (V)			Maximum		Max. T.(°C)	Frequency Resp.(MHz)	Leakage		Gain		
						V _{ce}	V _{ce}	V _{ce}	I _c	Power			I _c @ V _{ce}	V _{ce}	N _{FB} @ I _c		
FK2484	-N	S	FSC	925	925A	60	60	6.0	.050A	.175W	200J	60.000G	10NA	45V	290		
FK2894	-N	S	FSC	925	925A	12	12	4.0		.175W	200J	350.000G	10UA	6V	76	.030A	
FK3014	-N	S	FSC	925	925A	40	20	5.0		.175W	200J	300.000G	300NA	20V	60	.030A	
FK3299	-N	S	FSC	925	925A	60	30	5.0		.175W	200J	200.000G	10NA	50V	75	.150A	
FK3300	-N	S	FSC	925	925A	60	30	2.0		.175W	200J	200.000G	10NA	50V	220	.150A	
FK3502	-N	S	FSC	925	925A	45	45	5.0		.175W	200J	150.000G	10NA	30V	150	.150A	
FK3503	-P	S	FSC	925	925A	60	60	5.0	.500A	.175W	200J	150.000G	10NA	50V	150	.150A	
FM870	-N	S	FSC	211	TO 46	100	60	7.0		.375W	200A	50.000G	10NA	75V	80		
FM871	-N	S	FSC	211	TO 46	100	60	7.0		.375W	200A	60.000G	10NA	75V	160		
FT194			SEE 2N3963														
FT19M			SEE 2N3963														
FT34A	-N	S	FSC	561	TO 59	150	80	6.0		15.000W	200J	800.000G	10UA	75V	85	2.000A	
FT34B	-N	S	FSC	561	TO 59	120	60	6.0		15.000W	200J	800.000G	10UA	60V	210	2.000A	
FT34C	-N	S	FSC	211	TO 5	150	80	6.0		.800W	200J	800.000G	10UA	75V	85	2.000A	
FT34D	-N	S	FSC	211	TO 5	120	60	6.0		.800W	200J	800.000G	10UA	60V	210	2.000A	
FT40			SEE 2N4251														
FT45			SEE 2N4134														
FT207A			SEE 2N4115														
FT207B			SEE 2N4116														
FT400A	-P	S	FSC	560	TO 59	80	80	5.0		30.000W	200J	120.000G	50UA	40V	180	2.000A	
FT400B	-P	S	FSC	560	TO 59	80	80	5.0		30.000W	200J	60.000G	50UA	40V	70	2.000A	
FT709	-N	S	FSC	211	TO 18	25	10	5.0		.300W	200A	600.000G	50NA	5V	70		
FT1341	-N	S	FSC	211	TO 18	25	10	5.0		.360W	200J	300.000G	100NA	30V	60		
FT1702			SEE 2N4208														
FT1746	P	S	FSC	211	TO 18	35	30	4.0		.360W	200J	100.000G	5NA	15V	40		
FT7202A	-N	S	FSC	560	TO 59	120	80	8.0		30.000W	200J	70.000G	50UA	40V	70	2.000A	
FT7202B	-N	S	FSC	560	TO 59	100	60	8.0		30.000W	200J	70.000G	50UA	30V	70	2.000A	
FV914	-N	S	FSC	911	TO 51	40	5.0		.050A	.175W	200J	300.000G	25NA	20V	55	.010A	
FV918	-N	S	FSC	911	TO 51	30	3.0		.100A	.175W	200J	600.000G	10NA	15V	50	.003A	
FV2369A	-N	S	FSC	911	TO 51	40	4.5		.050A	.175W	200J	500.000G	30UA	20V	85	.010A	
FV2484	-N	S	FSC	911	TO 51	60	6.0			.175W	200J	60.000G	10NA	45V	290		
FV2894	-N	S	FSC	911	TO 51	12	4.0			.175W	200J	350.000G	10UA	6V	76	.030A	
FV3014	-N	S	FSC	911	TO 51	40	5.0			.175W	200J	300.000G	300NA	20V	60	.030A	
FV3299	-N	S	FSC	911	TO 51	60	5.0			.175W	200J	200.000G	10NA	50V	75	.150A	
FV3300	-N	S	FSC	911	TO 51	60	5.0			.175W	200J	200.000G	10NA	50V	75	.150A	
FV3502	-N	S	FSC	911	TO 51	60	5.0		.500A	.175W	200J	150.000G	30UA	20V	85	.030A	
FV3503	-P	S	FSC	911	TO 51	60	5.0		.500A	.175W	200J	150.000G	10NA	50V	150	.150A	
FX709	-N	S	FSC	926	TO 120	15	6	4.0		.210W	175J	600.000G	50NA	5V	70	.010A	
FX914	N	S	FSC	926	TO 120	40	15	5.0		.270W	175J	300.000G	25NA	20V	55	.010A	
FX918	N	S	FSC	926	TO 120	30	15	3.0		.050A	.240W	175J	600.000G	10NA	15V	50	.003A
FX2368	N	S	FSC	926	TO 120	40	15	4.5		.100A	.240W	175J	400.000G	400NA	20V	50	.010A
FX2369A	N	S	FSC	926	TO 120	40	15	4.5		.100A	.240W	175J	500.000G	400NA	20V	66	.010A
FX2483	N	S	FSC	926	TO 120	60	60	6.0		.050A	.270W	175J	60.000G	10NA	45V	230	.001A
FX2484	N	S	FSC	926	TO 120	60	60	6.0		.050A	.270W	175J	60.000G	10NA	45V	450	.001A
FX3013	N	S	FSC	926	TO 120	40	15	5.0		.260W	175J	300.000G	300NA	20V	80	.030A	
FX3014	N	S	FSC	926	TO 120	40	20	5.0		.260W	175J	350.000G	300NA	20V	60	.030A	
FX3299	N	S	FSC	926	TO 120	60	30	5.0		.270W	175J	200.000G	10NA	50V	75	.150A	
FX3300	N	S	FSC	926	TO 120	60	30	5.0		.270W	175J	250.000G	10NA	50V	220	.150A	
FX3502	P	S	FSC	926	TO 120	45	45	5.0	.500A	.270W	175J	150.000G	10NA	30V	150	.150A	
FX3503	P	S	FSC	926	TO 120	60	60	5.0	.500A	.270W	175J	250.000G	10NA	50V	150	.150A	
FX3724	N	S	FSC	926	TO 120	50	30	6.0	1.000A	.306W	175J	240.000G	2UA	40V	90	.100A	
FX3725	N	S	FSC	926	TO 120	80	50	6.0	1.000A	.306W	175J	240.000G	2UA	60V	90	.100A	
FX3962	N	S	FSC	926	TO 120	60	60	6.0		.270W	175J	40.000G	10NA	50V	260	.001A	
FX3963	P	S	FSC	926	TO 120	80	80	6.0		.270W	175J	40.000G	10NA	70V	330	.001A	
FX3964	P	S	FSC	926	TO 120	6	45	6.0		.270W	175J	40.000G	10NA	40V	260	.001A	
FX3965	P	S	FSC	926	TO 120	60	60	6.0	.100A	.270W	175J	40.000G	10NA	50V	330	.001A	
FX4034	P	S	FSC	926	TO 120	40	40	5.0	.100A	.240W	175J	400.000G	15NA	30V	150	.010A	
FX4046	N	S	FSC	926	TO 120	50	30	6.0	.500A	.306W	175J	240.000G	2UA	40V	90	.100A	
FX4047	N	S	FSC	926	TO 120	80	50	6.0	.500A	.306W	175J	240.000G	2UA	60V	90	.100A	
FX4207	N	S	FSC	926	TO 120	6	6	4.5	.050A	.240W	175J	650.000G	10NA	30V	100	.010A	
FX4960	N	S	FSC	926	TO 120	60	60	6.5		.306W	175J	200.000G	10NA	50V	180	.150A	
GE-1	P	G	GEC	210	TO 5	12			.100A	.150W		RF AMP					
GE-2	P	G	GEC	210	TO 5	20			.200A	.200W		AUD					
GE-3	P	G	GEC	605	TO 3	50			3.000A	25.000W		AUD					
GE-4	P	G	GEC	405	TO 36	50			12.000A	50.000W		AUD					
GE-5	N	G	GEC	210	TO 5	12			.100A	.150W		RF AMP					
GE-6	N	G	GEC	10	10H	15			.020A	.065W		RF AMP					
GE-7	N	G	GEC	10	10H	15			.020A	.065W		IF AMP					
GE-8	N	G	GEC	210	TO 5	20			.200A	.150W		AUD					
GE-9	P	G	GEC	217	217F	12			.006A	.080W		FM IF					
GE-10	N	S	GEC	45	TO 98	25			.100A	.200W		RF AMP					
GE-11	N	S	GEC	45	TO 98	30			.025A	.200W		UHf AMP					
GE-12	N	S	GEC	605	TO 66	300			.300A	10.000W		AUD					
GE-13MP			M.P. GE-3														
GE-14	N	S	GEC	605	TO 3	100			15.000A	115.000W		AUD					
GE-15MP			M.P. GE-14														
GE-16	P	G	GEC	605	TO 3	60			10.000A	90.000W		AUD					
GE-17	N	S	GEC	210	TO 170F	80			.100A	.500W		UHf AMP					
GE-18	N	S	GEC	210	TO 5	80			.500A	.800W		AUD					
GE-19	N	S	GEC	605	TO 3	50			4.000A	90.000W		AUD					
GE-20	N	S	GEC	210	TO 18	25			.500A	.500W		50.000G					
GE-21	N	S	GEC	210	TO 5	25			.500A	.500W		50.000G					
GE-22	P	S	GEC	170	170F	25			.500A	.500W		100.000G					
GE-23	N	S	GEC	605	TO 66	40			2.000A	15.000W		AUD					
GE-24MP			M.P. GE-23														
GE-25	P	G	GEC	605	TO 3	325			10.000A	50.000W		HR AMP					
GE-26	P	G	GEC	605	TO 66	60			2.000A	20.000W		10.000G			100		
GET706	N	S	GEC	168	168B	40	15	5.0	.200A	.360W	125J	200.000G	50NA	20V	30	.010A	
GET708	N	S	GEC	168	168B	40	15	5.0	.200A	.360W	125J	300.000G	50NA	20V	60	.010A	
GET914	N	S	GEC	168	168B	40	15	5.0	.200A	.360W	125J	300.000G	50NA	20V	60	.010A	
GET929	N	S	GEC	168	168B	40	15	5.0	.100A	.360W	125J	90.000G	10NA	50V	80	.001A	
GET930	N	S	GEC	168	168B	70	50	5.0	.200A	.360W	125J	90.000G	50NA	50V	175	.001A	
GET2221	N	S	GEC	168	168B	60	30	5.0	.400A	.360W	125J	250.000G	10NA	50V	70	.150A	
GET2222	N	S	GEC	168	168B	60	30	5.0	.400A	.360W	125J	250.000G	10NA	50V	175	.150A	
GET2369	N	S	GEC	168	168B	40	15	5.0	.200A	.360W	125J	350.000G	10NA	20V	70	.010A	
GET30																	

Transistor Type No.	N P	G S	Manufacturer	Lead (Ident)	Out- line	Maximum (V)			Maximum		Max. T. _c (°C)	Frequency Resp.(MHz)	Leakage		Gain	
						V _{CE}	V _{BE}	V _{ES}	I _c	Power			I _{CEO} @ V _{CE}	I _{ES}	h _{FE} @ I _c	
GI-2924	N	S	GIC	173	TO106	25	25	5.0		200W	125J			225	.002A	
GI-2925	N	S	GIC	173	TO106	25	25	5.0		200W	125J			253	.002A	
GI-2926	N	S	GIC	173	TO106	18	18	5.0		200W	125J			153	.002A	
GI-3391	N	S	GIC	173	TO106	25	25	5.0		200W	125J			375	.002A	
GI-3392	N	S	GIC	173	TO106	25	25	5.0		200W	125J			375	.002A	
GI-3393A	N	S	GIC	173	TO106	25	25	5.0	100A	200W	125J		100NA	25V	225	.002A
GI-3392	N	S	GIC	173	TO106	25	25	5.0	100A	200W	125J		100NA	25V	135	.002A
GI-3393	N	S	GIC	173	TO106	25	25	5.0	100A	200W	125J		100NA	25V	83	.002A
GI-3394	N	S	GIC	173	TO106	25	25	5.0	100A	200W	125J		100NA	25V	275	.002A
GI-3395	N	S	GIC	173	TO106	25	25	5.0	100A	200W	125J		100NA	25V	275	.002A
GI-3396	N	S	GIC	173	TO106	25	25	5.0	100A	200W	125J		100NA	25V	215	.002A
GI-3397	N	S	GIC	173	TO106	25	25	5.0	100A	200W	125J		100NA	25V	180	.002A
GI-3398	N	S	GIC	173	TO106	25	25	5.0	100A	200W	125J		100NA	25V	255	.002A
GI-3402	N	S	GIC	173	TO106	25	25	5.0	500A	200W	125J		100NA	25V	131	.002A
GI-3403	N	S	GIC	173	TO106	25	25	5.0	500A	200W	125J		100NA	25V	315	.002A
GI-3404	N	S	GIC	173	TO106	50	50	5.0	500A	200W	125J		100NA	50V	131	.002A
GI-3405	N	S	GIC	173	TO106	50	50	5.0	500A	200W	125J		100NA	50V	315	.002A
GI-3414	N	S	GIC	173	TO106	25	25	5.0	500A	300W	125J	AUG	100NA	25V	131	.002A
GI-3415	N	S	GIC	173	TO106	25	25	5.0	500A	300W	125J	AUG	100NA	25V	315	.002A
GI-3416	N	S	GIC	173	TO106	50	50	5.0	500A	360W	125J	AUG	100NA	25V	131	.002A
GI-3417	N	S	GIC	173	TO106	50	50	5.0	500A	360W	125J	AUG	100NA	25V	315	.002A
GI-3566	N	S	GIC	173	TO106	50	50	5.0	200A	300W	125J	40.000G	50NA	20V	300	.010A
GI-3605	N	S	GIC	173	TO106	18	14	2.0		300W	125J	300.000G	500NA	18V	45	.010A
GI-3606	N	S	GIC	173	TO106	18	14	5.0		200W	125J	300.000G	500NA	18V	45	.010A
GI-3607	N	S	GIC	173	TO106	25	25	4.0		300W	125J	100.000G	35NA	15V	45	.050A
GI-3638	P	S	GIC	173	TO106	25	25	5.0		300W	125J	150.000G	35NA	15V	150	.050A
GI-3638A	P	S	GIC	173	TO106	60	30	5.0	500A	350W	125J	250.000G	50NA	50V	68	.150A
GI-3642	N	S	GIC	173	TO106	60	45	5.0	500A	300W	125J	250.000G	50NA	50V	70	.150A
GI-3643	N	S	GIC	173	TO106	60	30	5.0	500A	350W	125J	250.000G	50NA	50V	175	.150A
GI-3644	N	S	GIC	173	TO106	45	45	5.0	500A	300W	125J	200.000G	35NA	30V	175	.150A
GI-3702	P	S	GIC	173	TO106	25	25	5.0	200A	300W	125J	100.000G	100NA	20V	135	.050A
GI-3703	N	S	GIC	173	TO106	50	30	5.0	200A	300W	125J	100.000G	100NA	20V	68	.010A
GI-3704	N	S	GIC	173	TO106	50	30	5.0	800A	360W	125J	100.000G	100NA	20V	175	.050A
GI-3705	N	S	GIC	173	TO106	50	30	5.0	800A	360W	125J	100.000G	100NA	20V	88	.050A
GI-3706	N	S	GIC	173	TO106	40	20	6.0	800A	360W	125J	100.000G	100NA	20V	180	.050A
GI-3707	N	S	GIC	173	TO106	30	30	6.0	030A	250W	125J	AUG	100NA	20V	200	.001A
GI-3708	N	S	GIC	173	TO106	30	30	6.0	030A	250W	125J	AUG	100NA	20V	210	.001A
GI-3709	N	S	GIC	173	TO106	30	30	6.0	030A	250W	125J	AUG	100NA	20V	86	.001A
GI-3710	N	S	GIC	173	TO106	30	30	6.0	030A	250W	125J	AUG	100NA	20V	172	.001A
GI-3711	N	S	GIC	173	TO106	30	30	6.0	030A	250W	125J	AUG	100NA	20V	330	.001A
GI-3721	N	S	GIC	173	TO106	18	18	5.0	100A	200W	125J	100.000G	500NA	18V	225	.002A
GI-3793	N	S	GIC	173	TO106	40	20	5.0	500A	250W	125J	100.000G	50NA	50V	50	.010A
GI-3794	N	S	GIC	173	TO106	40	20	5.0	500A	250W	125J	100.000G	500NA	15V	250	.010A
GI-3900	N	S	GIC	173	TO106	18	18	5.0	100A	200W	125J	AUG	100NA	18V	375	.002A
GI-3900A	N	S	GIC	173	TO106	18	18	5.0	100A	200W	125J	AUG	100NA	18V	375	.002A
GT34HV			SEE 2N1408													
GT40	-P	G	AEI	55	55C	15	15	12.0	.250A	.100W	75J	2.000B	15UA	15V	30	
GT41	-P	G	AEI	55	55C	15	15R	12.0	.250A	.100W	75J	3.000B	15UA	15V	30	
GT42	-P	G	AEI	55	55C	15	15R	12.0	.250A	.100W	75J	5.000B	15UA	15V	60	
GT43	-P	G	AEI	55	55C	25	25	12.0	.250A	.100W	75J	7.000B	15UA	15V	100	
GT44	-P	G	AEI	55	55C	25	25	12.0	.250A	.100W	75J	2.000B	15UA	15V	30	
GT45	-P	G	AEI	55	55C	25	25R	12.0	.250A	.100W	75J	3.000B	15UA	15V	30	
GT46	-P	G	AEI	55	55C	25	25R	12.0	.250A	.100W	75J	5.000B	15UA	15V	60	
GT47	-P	G	AEI	55	55C	25	25R	12.0	.250A	.100W	75J	7.000B	15UA	15V	100	
GT81	-P	G	GTIC	170	TO 9	25	25R	10.0	.150W	100J	AUG	100A	10V	70		
GT1200			SEE 2N1310													
GT1658			SEE 2N1605													
H5			SEE 2N538A													
H6			SEE 2N539A													
H7			SEE 2N540A													
H12			SEE 2N1157													
H12A			SEE 2N157A													
HA7520	P	S	HUG	903	903A	35	35	35.0	1.000W				100NA	35V	10	.001A
HA7521	P	S	HUG	903	903A	60	60	60.0	1.000W				100NA	60V	10	.001A
HA7522	P	S	HUG	903	903A	35	15	15.0	1.000W				100NA	35V	22	.001A
HA7523	P	S	HUG	903	903A	35	35	35.0	1.000W				100NA	35V	22	.001A
HA7524	P	S	HUG	903	903A	60	60	60.0	1.000W				100NA	60V	22	.001A
HA7525	P	S	HUG	903	903A	110	110	110.0	1.000W				100NA	110V	22	.001A
HA7526	P	S	HUG	903	903A	15	15	15.0	1.000W				100NA	15V	44	.001A
HA7527	P	S	HUG	903	903A	35	35	35.0	1.000W				100NA	35V	44	.001A
HA7528	P	S	HUG	903	903A	60	60	60.0	1.000W				100NA	60V	44	.001A
HA7529	P	S	HUG	903	903A	90	90	90.0	1.000W				100NA	90V	22	.001A
HA7530	P	S	HUG	210	TO 5	35	35	35.0	.400W				100NA	35V	10	.001A
HA7531	P	S	HUG	210	TO 5	60	60	60.0	.400W				100NA	60V	10	.001A
HA7532	P	S	HUG	210	TO 5	15	15	15.0	.400W				100NA	15V	220	.001A
HA7533	P	S	HUG	210	TO 5	35	35	35.0	.400W				100NA	35V	22	.001A
HA7534	P	S	HUG	210	TO 5	60	60	60.0	.400W				100NA	60V	22	.001A
HA7535	P	S	HUG	210	TO 5	110	110	110.0	.400W				100NA	110V	22	.001A
HA7536	P	S	HUG	210	TO 5	35	35	35.0	.400W				100NA	35V	44	.001A
HA7537	P	S	HUG	210	TO 5	35	35	35.0	.400W				100NA	35V	44	.001A
HA7538	P	S	HUG	210	TO 5	60	60	60.0	.400W				100NA	60V	44	.001A
HA7539	P	S	HUG	210	TO 5	90	90	90.0	.400W				100NA	90V	22	.001A
HA7597	P	S	HUG	903	903A	40	20	20.0	.400W				100NA	50V	14	.001A
HA7598	P	S	HUG	903	903A	35	20	20.0	.400W				100NA	50V	29	.001A
HA7599	P	S	HUG	903	903A	30	20	20.0	.400W				100NA	50V	58	.001A
HEP1	P	S	MOT	210	TO 18	12	12S	2.0	.100A	.150W	100J	100.000G		50		
HEP2	P	S	MOT	210	TO 5	22	22S	.6	.100A	.300W	100J	1000.000G		75		
HEP3	P	S	MOT	210	TO 72	20	20S	.5	.050A	.100W	100J	250.000G		85		
HEP50	N	S	MOT	210	TO 18	25	15	4.0	.400A	.400W	175J	250.000G		85		
HEP51	P	S	MOT	210	TO 5	30	25	4.0	.600A	.600W	175J	350.000G		80		
HEP52	P	S	MOT	210	TO 18	30	30	4.0	.200A	.400W	175J	200.000G		95		
HEP53	N	S	MOT	210	TO 5	35	30	4.0	.600A	.600W	175J	200.000G		85		
HEP54	N	S	MOT	41	TO 92	30	20	5.0	.200A	.310W	135J	300.000G		350		
HEP55	N	S	MOT	42	TO 92	30	20	5.0	.3100A	.310W	135J	750.000G		350		

Transistor Type No.	N P S	G S	Manufacturer	Lead Ident	Out- line	Maximum (V)			Maximum		T.C. Temp.	Frequency Resp.(MHz)	Leakage I _{sat} @ V _{ce}	Gain h _{FE} @ I _c
						V _{ce}	V _{ce}	V _{ce}	I _c	Power				
HEP243	N	S	MOT	211	TO 5	60	40	6.0	3.000A	6.000W	200J	8.000G	60	
HEP244	N	S	MOT	48	48A	300	300	3.0	500A	25.000W	150J	15.000G	30	
HEP245	N	S	MOT	48	48A	60	40	5.0	3.000A	30.000W	150J	8.000G	60	
HEP246	N	S	MOT	48	48A	60	40	5.0	3.000A	30.000W	150J	8.000G	60	
HEP247	N	S	MOT	605	TO 3	70	50	7.0	10.000A	150.000W	200J	5.000G	50	
HEP248	N	S	MOT	605	TO 3	70	50	7.0	10.000A	150.000W	200J	5.000G	50	
HEP250	N	S	MOT	210	TO 5	20	20S	2.5	200A	200W	85J	1.500G	65	
HEP251	N	S	MOT	210	TO 5	20	20S	2.0	200A	200W	85J	2.500G	150	
HEP252	N	S	MOT	210	TO 5	20	20S	2.0	200A	200W	85J	1.500G	65	
HEP253	N	S	MOT	212	TO 5	20	20S	4.0	400A	22.5W	100J	2.000G	40	
HEP254	N	S	MOT	605	TO 3	60	35S	20.0	7.000A	77.000W	110J	.600G	70	
HEP623	N	S	MOT	605	TO 3	60	35S	20.0	7.000A	77.000W	110J	.600G	120	
HEP624	N	S	MOT	605	TO 3	60	35S	20.0	7.000A	77.000W	110J	.600G	40	
HEP625	N	S	MOT	605	TO 3	100	75S	50.0	10.000A	90.000W	110J	1.000G	60	
HEP626	N	S	MOT	605	TO 3	80	50S	2.0	20.000A	85.000W	110J	1.000G	40	
HEP627	N	S	MOT	605	TO 3	80	80S	5.0	10.000A	85.000W	110J	.700G	40	
HEP628	N	S	MOT	605	TO 3	60	35S	20.0	7.000A	77.000W	110J	.600G	45	
HEP629	N	S	MOT	210	TO 5	55	40S	30.0	400A	200W	100J	1.000G	110	
HEP630	N	S	MOT	210	TO 5	55	40S	30.0	400A	200W	100J	1.000G	50	
HEP631	N	S	MOT	210	TO 5	40	25S	25.0	200A	200W	100J	1.500G	45	
HEP632	N	S	MOT	210	TO 5	40	25S	25.0	200A	200W	100J	2.000G	80	
HEP633	N	S	MOT	210	TO 5	40	25S	25.0	200A	200W	100J	2.500G	160	
HEP634	N	S	MOT	210	TO 5	40	25S	25.0	200A	200W	100J	3.000G	350	
HEP635	N	S	MOT	210	TO 5	30	25S	5.0	100A	150W	100J	100.000G	85	
HEP636	N	S	MOT	210	TO 18	35	35S	3.0	100A	150W	100J	600.000G	120	
HEP637	N	S	MOT	217	TO 72	20	15S	.3	.010A	.150W	100J	800.000G	120	
HEP638	N	S	MOT	210	TO 5	30	20S	.5	.050A	.060W	100J	100.000G	60	
HEP639	N	S	MOT	120	TO 1	18	18S	.5	.050A	.055W	100J	100.000G	70	
HEP640	N	S	MOT	120	TO 1	18	18S	.5	.050A	.055W	100J	100.000G	130	
HEP641	N	S	MOT	210	TO 5	25	15S	10.0	300A	.150W	85J	150.000G	70	
HEP700	N	S	MOT	48	48A	40	40	5.0	5.000A	40.000W	150J	8.000G	70	
HEP701	N	S	MOT	48	48A	40	40	5.0	3.000A	40.000W	150J	8.000G	80	
HEP702	N	S	MOT	605	TO 66	70	60	5.0	5.000A	25.000W	150J	6.000G	85	
HEP703	N	S	MOT	605	TO 3	100	60	7.0	15.000A	115.000W	200J	1.000G	90	
HEP704	N	S	MOT	605	TO 3	40	40	5.0	5.000A	87.500W	200J	4.000G	25	
HEP705	N	S	MOT	211	TO 5	35	32S	5.0	100A	6.000W	175J	10.000G	25	
HEP706	N	S	MOT	605	TO 3	400	32S	5.0	10.000A	115.000W	300J	2.500G	65	
HEP707	N	S	MOT	210	TO 18	60	60	5.0	600A	1.800W	175J	275.000G	85	
HEP708	N	S	MOT	217	TO 72	30	15	3.0	.050A	.300W	175J	600.000G	120	
HEP709	N	S	MOT	211	TO 5	95	80	4.5	100A	3.000W	200J	200.000G	25	
HEP710	N	S	MOT	210	TO 5	180	20S	5.0	.050A	1.000W	175J	150.000G	35	
HEP711	N	S	MOT	211	TO 5	100	100	5.0	200A	1.000W	175J	150.000G	35	
HEP712	N	S	MOT	49	49A	150	150	5.0	1.000A	1.000W	175J	100.000G	120	
HEP713	N	S	MOT	41	TO 92	50	40	4.0	200A	.310W	135J	200.000G	120	
HEP714	N	S	MOT	41	TO 92	40	40	5.0	600A	.310W	135J	300.000G	110	
HEP715	N	S	MOT	41	TO 92	25	25	4.0	100A	.310W	135J	600.000G	350	
HEP716	N	S	MOT	41	TO 92	30	20	4.0	100A	.310W	135J	600.000G	80	
HEP717	N	S	MOT	41	TO 92	30	30	4.0	100A	.310W	135J	700.000G	130	
HEP718	N	S	MOT	41	TO 92	30	30	3.0	100A	.310W	135J	800.000G	40	
HEP719	N	S	MOT	41	TO 92	30	30	3.0	100A	.310W	135J	800.000G	350	
HEP720	N	S	MOT	41	TO 92	25	25	4.0	100A	.310W	135J	200.000G	60	
HEP721	N	S	MOT	41	TO 92	25	25	4.0	100A	.310W	135J	200.000G	90	
HEP722	N	S	MOT	41	TO 92	25	25	4.0	100A	.310W	135J	200.000G	160	
HEP723	N	S	MOT	41	TO 92	25	25	4.0	100A	.310W	135J	200.000G	250	
HEP724	N	S	MOT	41	TO 92	25	25	4.0	100A	.310W	135J	200.000G	350	
HEP725	N	S	MOT	41	TO 92	25	25	4.0	100A	.310W	135J	200.000G	50	
HEP726	N	S	MOT	41	TO 92	25	25	4.0	100A	.310W	135J	200.000G	180	
HEP727	N	S	MOT	41	TO 92	25	25	4.0	100A	.310W	135J	200.000G	100	
HEP728	N	S	MOT	41	TO 92	25	25	4.0	100A	.310W	135J	200.000G	600	
HEP729	N	S	MOT	41	TO 92	25	25	4.0	100A	.310W	135J	200.000G	130	
HEP730	N	S	MOT	41	TO 92	20	20	4.0	.025A	.310W	135J	30.000G	45	
HEP731	N	S	MOT	41	TO 92	20	20	4.0	.025A	.310W	135J	100.000G	95	
HEP732	N	S	MOT	41	TO 92	40	20	4.0	.025A	.310W	135J	200.000G	75	
HEP733	N	S	MOT	41	TO 92	40	20	4.0	.025A	.310W	135J	200.000G	300	
HEP734	N	S	MOT	41	TO 92	55	50	6.0	.600A	.310W	135J	150.000G	140	
HEP735	N	S	MOT	41	TO 92	30	25	6.0	100A	.310W	135J	100.000G	600	
HEP736	N	S	MOT	41	TO 92	45	40	7.0	100A	.310W	135J	100.000G	250	
HEP737	N	S	MOT	41	TO 92	45	40	7.0	100A	.310W	135J	100.000G	80	
HEP738	N	S	MOT	210	TO 5	15	10	5.0	200A	100W	100J	3.000G	40	
HEP739	N	S	MOT	210	TO 5	15	10	5.0	200A	100W	100J	3.000G	100	
HF3H	N	S	SEM	210	TO 5	15	15	10.0	200A	100W	100J	6.000G	50	
HF3M	N	S	SEM	210	TO 5	18	15	10.0	200A	100W	100J	12.000G	100	
HF6H	N	S	SEM	210	TO 5	20	20	10.0	200A	250W	200J	20.000G	150	
HF6M	N	S	SEM	210	TO 5	20	20	10.0	200A	250W	200J	20.000G	80	
HF12H	N	S	SEM	210	TO 5	20	20	10.0	200A	250W	200J	20.000G	50	
HF12M	N	S	SEM	210	TO 5	20	20	10.0	200A	250W	200J	20.000G	150	
HF20H	N	S	SEM	210	TO 5	20	20	10.0	200A	250W	200J	20.000G	80	
HF20M	N	S	SEM	210	TO 5	20	20	10.0	200A	250W	200J	20.000G	50	
HF35	N	S	SEM	120	TO 58	20	20	2.0	100A	.150W	100J	100.000G	80	
HF50	N	S	SEM	120	TO 58	25	20	2.0	100A	.150W	100J	100.000G	80	
HF75	N	S	SEM	120	TO 58	25	20	2.0	100A	.150W	100J	100.000G	150	
HJ220	N	S	SEE 2SA12											
HJ230	N	S	SEE 2SA15											
HJ56	N	S	SEE 2SA13											
HJ57	N	S	SEE 2SA16											
HJ60	N	S	SEE 2SA17											
HJ70	N	S	SEE 2SA80											
HJ71	N	S	SEE 2SA81											
HJ72	N	S	SEE 2SA82											
HJ73	N	S	SEE 2SA83											
HJ74	N	S	SEE 2SA84											
HJ75	N	S	SEE 2SA85											
HN100	N	S	HUG	605	TO 3	100	50	5.0	5.000A	150.000W	200J	1.000G	20	
HN150	N	S	SEM	605	TO 3	150	120	7.0	15.000A	150.000W	200J	1.000G	20	
HO300	N	S	SEM	605	TO 3	300	250	2.0	10.000A	100.000W	200J	5.000G	20	
HST1050	N	S	HUG	605	TO 3	250	200	8.0	80.000W	80.000W	200J	50A 10W	23 1.000A	
HST1051	N	S	HUG	605	TO 3	400	325	8.0	80.000W	80.000W	200J	50A 10W	23 1.000A	
HST1052	N	S	HUG	605	TO 3	500	400	8.0	80.000W	80.000W	200J	50A 10W	23 1.000A	
HST1053	N	S	HUG	605	TO 3	600	400	8.0	80.000W	80.000W	200J	50A 10W	23 1.000A	
HST1054	N	S	HUG	605	TO 3	700	400	8.0	80.000W	80.000W	200J	50A 10W	23 1.000A	
HST1055	N	S	HUG	605	TO 3	250	200	8.0	80.000W	80.000W	200J	10A 15W	22 1.000A	
HST1056	N	S	HUG	605	TO 3	400	325	8.0	80.000W	80.000W	200J	10A 15W	22 1.000A	
HST1057	N	S	HUG	605	TO 3	500	400	8.0	80.000W	80.000W	200J	10A 15W	22 1.000A	
HST1058	N	S	HUG	605	TO 3	600	400	8.0	80.000W	80.000W	200J	10A 15W	22 1.000A	
HST1059	N	S	HUG	605	TO 3	700	400	8.0	80.000W	80.000W	200J	10A 15W	22 1.000A	
HST1060	N	S	HUG	605	TO 3	250	200	8.0	80.000W	80.000W	200J	10A 1		

Transistor Type No.	N / P / S	Manufacturer	Lead Ident	Out-line	Maximum (V) V _{CE} V _{ES} V _{ES}	Maximum I _C	Max. Power	Max. T.(°C)	Frequency Resp.(MHz)	Leakage I _{BES} @ V _{CE}	Gain h _{FE} @ I _C
HST1150	N S	HUG	605	TO 66	250 200 8.0		40.000W			1UA 150V	15 1.000A
HST1151	N S	HUG	605	TO 66	400 325 8.0		40.000W			1UA 150V	15 1.000A
HST1152	N S	HUG	605	TO 66	500 400 8.0		40.000W			1UA 150V	15 1.000A
HST1153	N S	HUG	605	TO 66	600 400 8.0		40.000W			1UA 150V	15 1.000A
HST1154	N S	HUG	605	TO 66	250 200 8.0		40.000W			1UA 150V	22 1.000A
HST1155	N S	HUG	605	TO 66	400 325 8.0		40.000W			1UA 150V	22 1.000A
HST1156	N S	HUG	605	TO 66	500 400 8.0		40.000W			1UA 150V	22 1.000A
HST1157	N S	HUG	605	TO 66	600 400 8.0		40.000W			1UA 150V	22 1.000A
HST1158	N S	HUG	605	TO 66	700 400 8.0		40.000W			1UA 150V	22 1.000A
HST1159	N S	HUG	605	TO 66	250 200 8.0		40.000W			5UA 100V	23 1.000A
HST1160	N S	HUG	605	TO 66	400 325 8.0		40.000W			5UA 100V	23 1.000A
HST1161	N S	HUG	605	TO 66	500 400 8.0		40.000W			5UA 100V	23 1.000A
HST1162	N S	HUG	605	TO 66	600 400 8.0		40.000W			5UA 100V	23 1.000A
HST1163	N S	HUG	605	TO 66	700 400 8.0		40.000W			5UA 100V	23 1.000A
HST1164	N S	HUG	561	TO 61	250 200 8.0		40.000W			5UA 100V	23 1.000A
HST1250	N S	HUG	561	TO 61	400 325 8.0		80.000W			5UA 100V	23 1.000A
HST1251	N S	HUG	561	TO 61	500 400 8.0		80.000W			5UA 100V	23 1.000A
HST1252	N S	HUG	561	TO 61	600 400 8.0		80.000W			5UA 100V	23 1.000A
HST1253	N S	HUG	561	TO 61	700 400 8.0		80.000W			5UA 100V	23 1.000A
HST1254	N S	HUG	561	TO 61	250 200 8.0		80.000W			5UA 100V	23 1.000A
HST1255	N S	HUG	561	TO 61	400 325 8.0		80.000W			5UA 100V	23 1.000A
HST1256	N S	HUG	561	TO 61	500 400 8.0		80.000W			5UA 100V	23 1.000A
HST1257	N S	HUG	561	TO 61	600 400 8.0		80.000W			5UA 100V	23 1.000A
HST1258	N S	HUG	561	TO 61	700 400 8.0		80.000W			5UA 100V	23 1.000A
HST1259	N S	HUG	561	TO 61	250 200 8.0		80.000W			5UA 100V	23 1.000A
HST1260	N S	HUG	561	TO 61	400 325 8.0		80.000W			5UA 100V	23 1.000A
HST1261	N S	HUG	561	TO 61	500 400 8.0		80.000W			5UA 100V	23 1.000A
HST1262	N S	HUG	561	TO 61	600 400 8.0		80.000W			5UA 100V	23 1.000A
HST1263	N S	HUG	561	TO 61	700 400 8.0		80.000W			5UA 100V	23 1.000A
HST1264	N S	HUG	561	TO 61	250 200 8.0		80.000W			5UA 100V	23 1.000A
HST2101	P G	HUG	390	390A	10 5		100.000W				60 99.000A
HST2110	P G	HUG	390	390A	10 5		100.000W				60 99.000A
HST2111	P G	HUG	390	390A	10 5		100.000W				60 99.000A
HST2112	P G	HUG	390	390B	10 5		100.000W				60 99.000A
HST2150	P G	HUG	390	390B	10 5		100.000W				60 99.000A
HST2151	P G	HUG	390	390B	10 5		100.000W				60 99.000A
HST2152	P G	HUG	390	390B	10 5		100.000W				60 99.000A
HST4451	N S	HUG	211	TO 5	80 40 8.0		4.000W		70.000G	1UA 60V	35 5.000A
HST4452	N S	HUG	211	TO 5	100 80 8.0		4.000W		70.000G	1UA 60V	35 5.000A
HST4453	N S	HUG	211	TO 5	80 40 8.0		4.000W		70.000G	1UA 60V	70 5.000A
HST4454	N S	HUG	211	TO 5	100 80 8.0		4.000W		70.000G	1UA 60V	70 5.000A
HST4455	N S	HUG	211	TO 5	80 40 8.0		4.000W		70.000G	1UA 60V	150 5.000A
HST4456	N S	HUG	211	TO 5	100 80 8.0		4.000W		70.000G	1UA 60V	150 5.000A
HST4483	N S	HUG	211	TO 5	60 40 8.0		4.000W		70.000G	1UA 60V	35 5.000A
HST4451	N S	HUG	490	490A	100 80 8.0		20.000W		70.000G	1UA 60V	70 5.000A
HST4452	N S	HUG	490	490A	100 80 8.0		20.000W		70.000G	1UA 60V	70 5.000A
HST4453	N S	HUG	490	490A	100 80 8.0		20.000W		70.000G	1UA 60V	70 5.000A
HST4454	N S	HUG	490	490A	100 80 8.0		20.000W		70.000G	1UA 60V	70 5.000A
HST4455	N S	HUG	490	490A	100 80 8.0		20.000W		70.000G	1UA 60V	150 5.000A
HST4456	N S	HUG	490	490A	100 80 8.0		20.000W		70.000G	1UA 60V	150 5.000A
HST4583	N S	HUG	490	490A	60 40 5.0		20.000W		70.000G	1UA 60V	35 5.000A
HST5001	N S	HUG	211	TO 46	60 40 8.0		4.000W		85.000G	100NA 30V	88 5.00A
HST5002	N S	HUG	211	TO 46	80 60 8.0		4.000W		85.000G	100NA 30V	88 5.00A
HST5003	N S	HUG	211	TO 46	100 80 8.0		4.000W		85.000G	100NA 30V	88 5.00A
HST5004	N S	HUG	211	TO 46	140 100 8.0		4.000W		85.000G	100NA 30V	88 5.00A
HST5005	N S	HUG	211	TO 46	180 120 8.0		4.000W		85.000G	100NA 30V	88 5.00A
HST5006	N S	HUG	211	TO 46	60 40 8.0		4.000W		85.000G	100NA 30V	45 5.00A
HST5007	N S	HUG	211	TO 46	80 60 8.0		4.000W		85.000G	100NA 30V	45 5.00A
HST5008	N S	HUG	211	TO 46	100 80 8.0		4.000W		85.000G	100NA 30V	45 5.00A
HST5009	N S	HUG	211	TO 46	140 100 8.0		4.000W		85.000G	100NA 30V	45 5.00A
HST5010	N S	HUG	211	TO 46	180 120 8.0		4.000W		85.000G	100NA 30V	45 5.00A
HST5011	N S	HUG	211	TO 46	60 40 8.0		4.000W		85.000G	100NA 30V	180 5.00A
HST5012	N S	HUG	211	TO 46	80 60 8.0		4.000W		85.000G	100NA 30V	180 5.00A
HST5013	N S	HUG	211	TO 46	100 80 8.0		4.000W		85.000G	100NA 30V	180 5.00A
HST5014	N S	HUG	211	TO 46	140 100 8.0		4.000W		85.000G	100NA 30V	180 5.00A
HST5015	N S	HUG	211	TO 46	180 120 8.0		4.000W		85.000G	100NA 30V	180 5.00A
HST5051	N S	HUG	211	TO 46	175 150 8.0		4.000W		85.000G	100NA 60V	88 5.00A
HST5052	N S	HUG	211	TO 46	200 175 8.0		4.000W		85.000G	100NA 60V	88 5.00A
HST5053	N S	HUG	211	TO 46	225 200 8.0		4.000W		85.000G	100NA 60V	88 5.00A
HST5054	N S	HUG	211	TO 46	175 150 8.0		4.000W		85.000G	100NA 60V	45 5.00A
HST5055	N S	HUG	211	TO 46	200 175 8.0		4.000W		85.000G	100NA 60V	45 5.00A
HST5056	N S	HUG	211	TO 46	225 200 8.0		4.000W		85.000G	100NA 60V	45 5.00A
HST5501	N S	HUG	211	TO 5	60 40 8.0		4.000W		85.000G	100NA 30V	88 5.00A
HST5502	N S	HUG	211	TO 5	80 60 8.0		4.000W		85.000G	100NA 30V	88 5.00A
HST5503	N S	HUG	211	TO 5	100 80 8.0		4.000W		85.000G	100NA 30V	88 5.00A
HST5504	N S	HUG	211	TO 5	140 100 8.0		4.000W		85.000G	100NA 30V	88 5.00A
HST5505	N S	HUG	211	TO 5	180 120 8.0		4.000W		85.000G	100NA 30V	88 5.00A
HST5506	N S	HUG	211	TO 5	60 40 8.0		4.000W		85.000G	100NA 60V	45 5.00A
HST5507	N S	HUG	211	TO 5	80 60 8.0		4.000W		85.000G	100NA 60V	45 5.00A
HST5508	N S	HUG	211	TO 5	100 80 8.0		4.000W		85.000G	100NA 60V	45 5.00A
HST5509	N S	HUG	211	TO 5	140 100 8.0		4.000W		85.000G	100NA 60V	45 5.00A
HST5510	N S	HUG	211	TO 5	180 120 8.0		4.000W		85.000G	100NA 60V	45 5.00A
HST5511	N S	HUG	211	TO 5	60 40 8.0		4.000W		85.000G	100NA 30V	180 5.00A
HST5512	N S	HUG	211	TO 5	80 60 8.0		4.000W		85.000G	100NA 30V	180 5.00A
HST5513	N S	HUG	211	TO 5	100 80 8.0		4.000W		85.000G	100NA 30V	180 5.00A
HST5514	N S	HUG	211	TO 5	140 100 8.0		4.000W		85.000G	100NA 30V	180 5.00A
HST5515	N S	HUG	211	TO 5	180 120 8.0		4.000W		85.000G	100NA 30V	180 5.00A
HST5551	N S	HUG	211	TO 5	175 150 8.0		4.000W		85.000G	100NA 60V	88 5.00A
HST5552	N S	HUG	211	TO 5	200 175 8.0		4.000W		85.000G	100NA 60V	88 5.00A
HST5553	N S	HUG	211	TO 5	225 200 8.0		4.000W		85.000G	100NA 60V	88 5.00A
HST5554	N S	HUG	211	TO 5	175 150 8.0		4.000W		85.000G	100NA 60V	45 5.00A
HST5555	N S	HUG	211	TO 5	200 175 8.0		4.000W		85.000G	100NA 60V	45 5.00A
HST5556	N S	HUG	211	TO 5	225 200 8.0		4.000W		85.000G	100NA 60V	45 5.00A
HST5901	N S	HUG	605	TO 66	60 40 8.0		16.600W		85.000G	100NA 60V	88 5.00A
HST5902	N S	HUG	605	TO 66	80 60 8.0		16.600W		85.000G	100NA 60V	88 5.00A
HST5903	N S	HUG	605	TO 66	100 80 8.0		16.600W		85.000G	100NA 60V	88 5.00A
HST5904	N S	HUG	605	TO 66	140 100 8.0		16.600W		85.000G	100NA 60V	88 5.00A
HST5905	N S	HUG	605	TO 66	180 120 8.0		16.600W		85.000G	100NA 60V	88 5.00A
HST5906	N S	HUG	605	TO 66	60 40 8.0		16.600W		85.000G	100NA 60V	45 5.00A
HST5907	N S	HUG	605	TO 66	80 60 8.0		16.600W		85.000G	100NA 60V	45 5.00A
HST5908	N S	HUG	605	TO 66	100 80 8.0		16.600W		85.000G	100NA 60V	45 5.00A
HST5909	N S	HUG	605	TO 66	140 100 8.0		16.600W		85.000G	100NA 60V	45 5.00A
HST5910	N S	HUG	605	TO 66	180 120 8.0		16.600W		85.000G	100NA 60V	45 5.00A
HST5911	N S	HUG	605	TO 66	60 40 8.0		16.600W		85.000G	100NA 60V	180 5.00A
HST5912	N S	HUG	605	TO 66	80 60 8.0		16.600W		85.000G	100NA 60V	180 5.00A
HST5913	N S	HUG	605	TO 66	100 80 8.0		16.600W		85.000G	100NA 60V	180 5.00A
HST5914	N S	HUG	605	TO 66	140 100 8.0		16.600W		85.000G	100NA 60V	180 5.00A
HST5915	N S	HUG	605	TO 66	180 120 8.						

Transistor Type No.	N P S	G S	Manufacturer	Lead Ident	Out- line	Maximum (V)			Maximum		Max. T.(°C)	Frequency Resp.(MHz)	Leakage		Gain h _{FE} @ I _C
						V _{CE}	V _{BE}	V _{ES}	I _C	Power			I _{CE0}	I _{CE1}	
HST5952	N	S	HUG	605	TO 66	200	175	8.0	16.600W		85.000G	100NA	60V	88	5.000A
HST5953	N	S	HUG	605	TO 66	225	200	8.0	16.600W		85.000G	100NA	60V	88	5.000A
HST5954	N	S	HUG	605	TO 66	175	150	8.0	16.600W		85.000G	100NA	60V	45	5.000A
HST5955	N	S	HUG	605	TO 66	200	175	8.0	16.600W		85.000G	100NA	60V	45	5.000A
HST5956	N	S	HUG	605	TO 66	225	200	8.0	16.600W		85.000G	100NA	60V	45	5.000A
HST6001	N	S	HUG	561	TO 62	100	50	5.0	40.000W		70.000G	1UA	60V	15	5.000A
HST6011	N	S	HUG	561	TO 62	80	40	8.0	40.000W		70.000G	1UA	60V	35	5.000A
HST6012	N	S	HUG	561	TO 62	100	80	8.0	40.000W		70.000G	1UA	60V	35	5.000A
HST6013	N	S	HUG	561	TO 62	100	80	8.0	40.000W		70.000G	1UA	60V	70	5.000A
HST6014	N	S	HUG	561	TO 62	100	80	8.0	40.000W		70.000G	1UA	60V	70	5.000A
HST6015	N	S	HUG	561	TO 62	80	40	8.0	40.000W		70.000G	1UA	60V	150	5.000A
HST6016	N	S	HUG	561	TO 62	100	80	8.0	40.000W		70.000G	1UA	60V	150	5.000A
HST6031	N	S	HUG	561	TO 62	60	40	5.0	30.000W		70.000G	1UA	60V	35	5.000A
HST6308	N	S	HUG	561	TO111	60	40	8.0	30.000W		70.000G	1UA	60V	35	5.000A
HST6309	N	S	HUG	561	TO111	80	60	8.0	30.000W		70.000G	1UA	60V	35	5.000A
HST6310	N	S	HUG	561	TO111	100	80	8.0	30.000W		70.000G	1UA	60V	35	5.000A
HST6311	N	S	HUG	561	TO111	60	40	8.0	30.000W		70.000G	1UA	60V	70	5.000A
HST6312	N	S	HUG	561	TO111	80	60	8.0	30.000W		70.000G	1UA	60V	70	5.000A
HST6313	N	S	HUG	561	TO111	100	80	8.0	30.000W		70.000G	1UA	60V	70	5.000A
HST6314	N	S	HUG	561	TO111	60	40	8.0	30.000W		70.000G	1UA	60V	150	5.000A
HST6315	N	S	HUG	561	TO111	80	60	8.0	30.000W		70.000G	1UA	60V	150	5.000A
HST6316	N	S	HUG	561	TO111	100	80	8.0	30.000W		70.000G	1UA	60V	150	5.000A
HST6408	N	S	HUG	560	TO111	60	40	8.0	30.000W		70.000G	1UA	60V	35	5.000A
HST6409	N	S	HUG	560	TO111	100	80	8.0	30.000W		70.000G	1UA	60V	35	5.000A
HST6410	N	S	HUG	560	TO111	100	80	8.0	30.000W		70.000G	1UA	60V	35	5.000A
HST6411	N	S	HUG	560	TO111	80	40	8.0	30.000W		70.000G	1UA	60V	70	5.000A
HST6412	N	S	HUG	560	TO111	100	80	8.0	30.000W		70.000G	1UA	60V	70	5.000A
HST6413	N	S	HUG	560	TO111	80	60	8.0	30.000W		70.000G	1UA	60V	70	5.000A
HST6414	N	S	HUG	560	TO111	60	40	8.0	30.000W		70.000G	1UA	60V	150	5.000A
HST6415	N	S	HUG	560	TO111	80	60	8.0	30.000W		70.000G	1UA	60V	150	5.000A
HST6416	N	S	HUG	560	TO111	100	80	8.0	30.000W		70.000G	1UA	60V	150	5.000A
HST6801	N	S	HUG	605	TO 66	145	125	8.0	20.000W		70.000G	1UA	60V	35	5.000A
HST6902	N	S	HUG	605	TO 66	170	150	8.0	20.000W		70.000G	1UA	60V	35	5.000A
HST6903	N	S	HUG	605	TO 66	195	175	8.0	20.000W		70.000G	1UA	60V	35	5.000A
HST6904	N	S	HUG	605	TO 66	225	200	8.0	20.000W		70.000G	1UA	60V	35	5.000A
HST6905	N	S	HUG	605	TO 66	145	125	8.0	20.000W		70.000G	1UA	60V	70	5.000A
HST6906	N	S	HUG	605	TO 66	170	150	8.0	20.000W		70.000G	1UA	60V	70	5.000A
HST6907	N	S	HUG	605	TO 66	195	175	8.0	20.000W		70.000G	1UA	60V	70	5.000A
HST6908	N	S	HUG	605	TO 66	220	200	8.0	20.000W		70.000G	1UA	60V	70	5.000A
HST7011	N	S	HUG	561	TO 61	80	40	5.0	50.000W		60.000G	1UA	60V	35	5.000A
HST7012	N	S	HUG	561	TO 61	100	80	5.0	50.000W		60.000G	1UA	60V	35	5.000A
HST7013	N	S	HUG	561	TO 61	60	40	5.0	50.000W		60.000G	1UA	60V	35	5.000A
HST7014	N	S	HUG	561	TO 61	100	80	5.0	50.000W		60.000G	1UA	60V	35	5.000A
HST7015	N	S	HUG	561	TO 61	80	60	5.0	50.000W		60.000G	1UA	60V	70	5.000A
HST7016	N	S	HUG	561	TO 61	100	80	5.0	50.000W		60.000G	1UA	60V	70	5.000A
HST7017	N	S	HUG	561	TO 61	60	40	5.0	50.000W		60.000G	1UA	60V	150	5.000A
HST7018	N	S	HUG	561	TO 61	80	60	5.0	50.000W		60.000G	1UA	60V	150	5.000A
HST7019	N	S	HUG	561	TO 61	100	80	5.0	50.000W		60.000G	1UA	60V	150	5.000A
HST7140	N	S	HUG	561	TO 61	125	100	8.0	50.000W		60.000G	100NA	100V	70	5.000A
HST7141	N	S	HUG	561	TO 61	200	150	8.0	50.000W		60.000G	100NA	100V	70	5.000A
HST7150	N	S	HUG	561	TO 61	140	120	8.0	50.000W		60.000G	500NA	60V	35	5.000A
HST7151	N	S	HUG	561	TO 61	170	150	8.0	50.000W		60.000G	500NA	100V	35	5.000A
HST7152	N	S	HUG	561	TO 61	220	200	8.0	50.000W		60.000G	500NA	100V	35	5.000A
HST7154	N	S	HUG	561	TO 61	120	100	8.0	50.000W		60.000G	500NA	100V	35	5.000A
HST7155	N	S	HUG	561	TO 61	170	150	8.0	50.000W		60.000G	500NA	100V	70	5.000A
HST7156	N	S	HUG	561	TO 61	220	200	8.0	50.000W		60.000G	500NA	100V	70	5.000A
HST7201	N	S	HUG	605	TO 3	225	200	8.0	65.000W		50.000G	1UA	100V	35	5.000A
HST7202	N	S	HUG	605	TO 3	250	225	8.0	65.000W		50.000G	1UA	100V	35	5.000A
HST7203	N	S	HUG	605	TO 3	275	250	8.0	65.000W		50.000G	1UA	100V	35	5.000A
HST7204	N	S	HUG	605	TO 3	325	300	8.0	65.000W		50.000G	1UA	100V	35	5.000A
HST7205	N	S	HUG	605	TO 3	350	325	8.0	65.000W		50.000G	1UA	100V	35	5.000A
HST7206	N	S	HUG	605	TO 3	150	150	8.0	65.000W		50.000G	10UA	100V	22	5.000A
HST7207	N	S	HUG	605	TO 3	250	250	8.0	65.000W		50.000G	10UA	100V	22	5.000A
HST7208	N	S	HUG	605	TO 3	250	250	8.0	65.000W		50.000G	10UA	100V	22	5.000A
HST7209	N	S	HUG	605	TO 3	300	300	8.0	65.000W		50.000G	10UA	100V	22	5.000A
HST7401	N	S	HUG	211	TO 5	60	40	5.0	5.000W		50.000G	1UA	30V	70	5.000A
HST7402	N	S	HUG	211	TO 5	80	60	5.0	5.000W		50.000G	1UA	60V	70	5.000A
HST7403	N	S	HUG	211	TO 5	100	80	5.0	5.000W		50.000G	1UA	60V	70	5.000A
HST7411	N	S	HUG	211	TO 5	60	40	5.0	5.000W		50.000G	1UA	30V	35	5.000A
HST7412	N	S	HUG	211	TO 5	80	60	5.0	5.000W		50.000G	1UA	60V	35	5.000A
HST7413	N	S	HUG	211	TO 5	100	80	5.0	5.000W		50.000G	1UA	60V	35	5.000A
HST7414	N	S	HUG	211	TO 5	60	40	5.0	5.000W		50.000G	1UA	30V	70	5.000A
HST7415	N	S	HUG	211	TO 5	80	60	5.0	5.000W		50.000G	1UA	60V	70	5.000A
HST7416	N	S	HUG	211	TO 5	100	80	5.0	5.000W		50.000G	1UA	60V	70	5.000A
HST7417	N	S	HUG	211	TO 5	60	40	5.0	5.000W		50.000G	1UA	30V	150	5.000A
HST7418	N	S	HUG	211	TO 5	80	60	5.0	5.000W		50.000G	1UA	60V	150	5.000A
HST7419	N	S	HUG	211	TO 5	100	80	5.0	5.000W		50.000G	1UA	60V	150	5.000A
HST7601	N	S	HUG	607	TO 41	60	40	8.0	65.000W		60.000G	500NA	30V	70	5.000A
HST7602	N	S	HUG	607	TO 41	80	60	8.0	65.000W		60.000G	500NA	30V	70	5.000A
HST7603	N	S	HUG	607	TO 41	100	80	8.0	65.000W		60.000G	500NA	60V	70	5.000A
HST7604	N	S	HUG	607	TO 41	140	120	8.0	65.000W		60.000G	500NA	100V	70	5.000A
HST7605	N	S	HUG	607	TO 41	170	150	8.0	65.000W		60.000G	500NA	100V	70	5.000A
HST7606	N	S	HUG	607	TO 41	220	200	8.0	65.000W		60.000G	500NA	100V	70	5.000A
HST7607	N	S	HUG	607	TO 41	60	40	8.0	65.000W		60.000G	500NA	30V	35	5.000A
HST7608	N	S	HUG	607	TO 41	80	60	8.0	65.000W		60.000G	500NA	60V	35	5.000A
HST7609	N	S	HUG	607	TO 41	100	80	8.0	65.000W		60.000G	500NA	60V	35	5.000A
HST7610	N	S	HUG	607	TO 41	140	120	8.0	65.000W		60.000G	500NA	60V	35	5.000A
HST7611	N	S	HUG	607	TO 41	170	150	8.0	65.000W		60.000G	500NA	100V	35	5.000A
HST7612	N	S	HUG	607	TO 41	220	200	8.0	65.000W		60.000G	500NA	100V	35	5.000A
HST7801	N	S	HUG	561	TO 61	125	100	8.0	50.000W		50.000G	1UA	100V	35	5.000A
HST7802	N	S	HUG	561	TO 61	250	225	8.0	50.000W		50.000G	1UA	100V	35	5.000

Transistor Type No.	N P S	G S	Manufacturer	Lead Ident	Out- line	Maximum (V)			Maximum I _c	Power	Max. T (°C)	Frequency Resp.(MHz)	Leakage I _{CEO} @ V _{CE}	Gain h _{FE} @ I _c	
						V _{CE}	V _{ES}	V _{ES}							
HST8012	N	S	HUG	561	T0 63	80	60	8.0	100.000W		35.000G	10UA 60V	35	5.000A	
HST8013	N	S	HUG	561	T0 63	100	80	8.0	100.000W		35.000G	10UA 60V	35	5.000A	
HST8015	N	S	HUG	561	T0 63	80	60	8.0	100.000W		35.000G	10UA 60V	70	5.000A	
HST8016	N	S	HUG	561	T0 63	100	80	8.0	100.000W		35.000G	10UA 60V	70	5.000A	
HST8045	N	S	HUG	561	T0 63	45	25	5.0	100.000W		35.000G	10UA 25V	60	5.000A	
HST8070	N	S	HUG	561	T0 63	80	60	8.0	100.000W		35.000G	10UA 60V	150	5.000A	
HST8071	N	S	HUG	561	T0 63	100	80	8.0	100.000W		35.000G	10UA 60V	150	5.000A	
HST8105	N	S	HUG	913	913A	80	60	8.0	65.000W		35.000G	100UA 60V	70	5.000A	
HST8106	N	S	HUG	913	913A	100	80	8.0	65.000W		35.000G	100UA 60V	70	5.000A	
HST8110	N	S	HUG	913	913A	80	60	8.0	65.000W		35.000G	10UA 60V	150	5.000A	
HST8111	N	S	HUG	913	913A	100	80	8.0	65.000W		35.000G	10UA 60V	150	5.000A	
HST8112	N	S	HUG	913	913A	80	60	8.0	65.000W		35.000G	10UA 60V	35	5.000A	
HST8113	N	S	HUG	913	913A	100	80	8.0	65.000W		35.000G	10UA 60V	35	5.000A	
HST8114	N	S	HUG	913	913A	40	25	8.0	65.000W		35.000G	10UA 60V	60	5.000A	
HST8115	N	S	HUG	913	913A	80	60	8.0	65.000W		35.000G	10UA 60V	70	5.000A	
HST8116	N	S	HUG	913	913A	100	80	8.0	65.000W		35.000G	10UA 60V	70	5.000A	
HST8301	N	S	HUG	561	T0 63	80	60	8.0	100.000W		35.000G	10UA 60V	70	5.000A	
HST8302	N	S	HUG	561	T0 63	100	80	8.0	100.000W		35.000G	10UA 60V	70	5.000A	
HST8303	N	S	HUG	561	T0 63	80	60	8.0	100.000W		35.000G	10UA 60V	150	5.000A	
HST8304	N	S	HUG	561	T0 63	100	80	8.0	100.000W		35.000G	10UA 60V	150	5.000A	
HST8601	N	S	HUG	403	T0 68	80	60	8.0	166.000W		15.000G	10UA 60V	15	5.000A	
HST8602	N	S	HUG	403	T0 68	100	80	8.0	166.000W		15.000G	10UA 60V	15	5.000A	
HST8603	N	S	HUG	403	T0 68	120	100	8.0	166.000W		15.000G	10UA 60V	15	5.000A	
HST8604	N	S	HUG	403	T0 68	140	120	8.0	166.000W		15.000G	10UA 60V	15	5.000A	
HST8651	N	S	HUG	403	T0 68	200	200	8.0	166.000W		15.000G	10UA 100V	20	4.000A	
HST8652	N	S	HUG	403	T0 68	225	225	8.0	166.000W		15.000G	10UA 100V	20	5.000A	
HST8653	N	S	HUG	403	T0 68	250	250	8.0	166.000W		15.000G	10UA 100V	20	5.000A	
HST8654	N	S	HUG	403	T0 68	275	275	8.0	166.000W		15.000G	10UA 100V	20	5.000A	
HST8655	N	S	HUG	403	T0 68	300	300	8.0	166.000W		15.000G	10UA 100V	20	5.000A	
HST8801	N	S	HUG	561	T0 63	200	200	8.0	100.000W		30.000G	1UA 60V	30	4.000A	
HST8802	N	S	HUG	561	T0 63	225	225	8.0	100.000W		30.000G	1UA 60V	30	4.000A	
HST8803	N	S	HUG	561	T0 63	250	250	8.0	100.000W		30.000G	1UA 60V	30	4.000A	
HST8804	N	S	HUG	561	T0 63	275	275	8.0	100.000W		30.000G	1UA 60V	30	4.000A	
HST8805	N	S	HUG	561	T0 63	300	300	8.0	100.000W		30.000G	1UA 60V	30	4.000A	
HST8920	N	S	HUG	563	T0114	80	60	8.0	200.000W		15.000G	10UA 60V	15	4.000A	
HST8921	N	S	HUG	563	T0114	100	80	8.0	200.000W		15.000G	10UA 60V	15	4.000A	
HST8922	N	S	HUG	563	T0114	120	100	8.0	200.000W		15.000G	10UA 60V	15	4.000A	
HST8923	N	S	HUG	563	T0114	140	120	8.0	200.000W		15.000G	10UA 60V	15	4.000A	
HST8951	N	S	HUG	563	T0114	200	200	8.0	166.000W		15.000G	10UA 100V	20	4.000A	
HST8952	N	S	HUG	563	T0114	225	225	8.0	166.000W		15.000G	10UA 100V	20	4.000A	
HST8953	N	S	HUG	563	T0114	250	250	8.0	166.000W		15.000G	10UA 100V	20	4.000A	
HST8954	N	S	HUG	563	T0114	275	275	8.0	166.000W		15.000G	10UA 100V	20	4.000A	
HST8955	N	S	HUG	563	T0114	300	300	8.0	166.000W		15.000G	10UA 100V	20	4.000A	
HST9001	N	S	HUG	211	T0 5	50	30	5.0	4.000W		70.000G	1UA 25V	30	4.000A	
HST9002	N	S	HUG	211	T0 5	70	50	5.0	4.000W		70.000G	1UA 25V	30	4.000A	
HST9003	N	S	HUG	211	T0 5	90	70	5.0	4.000W		70.000G	1UA 25V	30	4.000A	
HST9004	N	S	HUG	211	T0 5	110	90	5.0	4.000W		70.000G	1UA 25V	30	4.000A	
HST9005	N	S	HUG	211	T0 5	130	100	5.0	4.000W		70.000G	1UA 25V	30	4.000A	
HST9006	N	S	HUG	211	T0 5	150	120	5.0	4.000W		70.000G	1UA 25V	30	4.000A	
HST9007	N	S	HUG	211	T0 5	170	140	5.0	4.000W		70.000G	1UA 25V	30	4.000A	
HST9008	N	S	HUG	211	T0 5	190	160	5.0	4.000W		70.000G	1UA 25V	30	4.000A	
HST9009	N	S	HUG	211	T0 5	210	180	5.0	4.000W		70.000G	1UA 25V	30	4.000A	
HST9010	N	S	HUG	211	T0 5	230	200	5.0	4.000W		70.000G	1UA 25V	30	4.000A	
HST9011	N	S	HUG	211	T0 5	250	220	5.0	4.000W		70.000G	1UA 25V	30	4.000A	
HST9012	N	S	HUG	211	T0 5	270	240	5.0	4.000W		70.000G	1UA 25V	30	4.000A	
HST9201	N	S	HUG	605	T0 3	45	12.0		115.000W		70.000G	700NA 30V	38	4.000A	
HST9202	N	S	HUG	605	T0 3	100	80	12.0	115.000W		70.000G	700NA 30V	38	4.000A	
HST9203	N	S	HUG	605	T0 3	120	100	12.0	115.000W		70.000G	700NA 30V	38	4.000A	
HST9204	N	S	HUG	605	T0 3	140	120	12.0	115.000W		70.000G	700NA 30V	38	4.000A	
HST9205	N	S	HUG	605	T0 3	160	140	12.0	115.000W		70.000G	700NA 30V	32	4.000A	
HST9206	N	S	HUG	605	T0 3	180	160	12.0	115.000W		70.000G	700NA 30V	32	4.000A	
HST9207	N	S	HUG	605	T0 3	200	180	12.0	115.000W		70.000G	700NA 30V	32	4.000A	
HST9208	N	S	HUG	605	T0 3	120	100	12.0	115.000W		70.000G	700NA 30V	32	4.000A	
HST9209	N	S	HUG	605	T0 3	140	120	12.0	115.000W		70.000G	700NA 30V	32	4.000A	
HST9210	N	S	HUG	605	T0 3	160	140	12.0	115.000W		70.000G	700NA 30V	32	4.000A	
HST9801	N	S	HUG	605	T0 3	40	30	5.0	83.000W		70.000G	5UA 20V	23	0.000A	
HST9802	N	S	HUG	605	T0 3	60	40	12.0	83.000W		70.000G	1UA 40V	35	4.000A	
HST9803	N	S	HUG	605	T0 3	80	60	12.0	83.000W		70.000G	1UA 60V	35	4.000A	
HST9804	N	S	HUG	605	T0 3	100	80	12.0	83.000W		70.000G	1UA 80V	35	4.000A	
HST9901	N	S	HUG	561	T0 61	100	100	12.0	61.000W		70.000G	1UA 100V	35	4.000A	
HST9902	N	S	HUG	561	T0 61	120	120	12.0	61.000W		70.000G	1UA 100V	35	4.000A	
HST9903	N	S	HUG	561	T0 61	140	140	12.0	61.000W		70.000G	1UA 100V	35	4.000A	
HST9904	N	S	HUG	561	T0 61	160	160	12.0	61.000W		70.000G	1UA 100V	35	4.000A	
JR5	P	G	SEM	120	TD 58	50	20	1.0	.200A		1.000G		70		
JR10	P	G	SEM	120	TD 58	20	1.0		.100A		.100G		50		
JR15	P	G	SEM	120	TD 58	35	25	20.0	.200A	.250W		5.00G	150		
JR30	P	G	SEM	120	TD 58	20	2.0		.100A	.100W		70.000G	100		
JR30X	P	G	SEM	120	TD 58	20	2.0		.100A	.100W		130.000G	150		
JR100	P	G	SEM	210	TD 18	12	1.0		.100A	.100W		150.000G	70		
JR200	P	G	SEM	210	TD 18	15	1.5	2.0	.100A	.100W		250.000G	100		
L10A	N	S	SEJ	607	607A	50	50	4.0	10.000A	200.000W	150J	5.000B	30		
L10B	N	S	SEJ	607	607A	100	100	4.0	10.000A	200.000W	150J	5.000B	30		
L10C	N	S	SEJ	607	607A	200	200	4.0	10.000A	200.000W	150J	5.000B	30		
L10D	N	S	SEJ	607	607A	300	300	4.0	10.000A	200.000W	150J	5.000B	30		
L20A	N	S	SEJ	607	607A	50	50	4.0	20.000A	200.000W	150J	5.000B	30		
L20B	N	S	SEJ	607	607A	100	100	4.0	20.000A	200.000W	150J	5.000B	30		
L20C	N	S	SEJ	607	607A	200	200	4.0	20.000A	200.000W	150J	5.000B	30		
L20D	N	S	SEJ	607	607A	300	300	4.0	20.000A	200.000W	150J	5.000B	30		
L30A	N	S	SEJ	607	607A	50	50	4.0	30.000A	200.000W	150J	5.000B	30		
L30B	N	S	SEJ	607	607A	100	100	4.0	30.000A	200.000W	150J	5.000B	30		
L30C	N	S	SEJ	607	607A	200	200	4.0	30.000A	200.000W	150J	5.000B	30		
L30D	N	S	SEJ	607	607A	300	300	4.0	30.000A	200.000W	150J	5.000B	30		
LDA400	N	S	AMP	890	890A	35	5.0	D	.030A	.360W	150J	250.000G	10NA 10V	70	.001A
LDA401	N	S	AMP	890	890A	35	5.0	D	.030A	.360W	150J	250.000G	10NA 10V	175	.001A
LDA402	N	S	AMP	890	890A	35									

Transistor Type No.	N P S	G F S	Manufacturer	Lead Ident	Out- line	Maximum (V)			Maximum		Max. T. ^(C)	Frequency Resp.(MHz)	Leakage		Gain		
						V _{CE}	V _{ES}	V _{EB}	V _C	Power			I _{CEO}	V _{CE}	I _{CE}	I _{CE}	I _C
LOS206	N	S	AMP	890	890A	20			.030A	.360W	150A	250.000G		150	45		
LOS208	N	S	AMP	890	890A	20			.300A	.360W	150A	5.000B		30	30		
M5A	N	S	SEI	605	T	3	50	4.0	5.000A	100.000W	150J	5.000B		30	30		
M5B	N	S	SEI	605	T	3	100	4.0	5.000A	100.000W	150J	5.000B		30	30		
M5C	N	S	SEI	605	T	3	200	4.0	5.000A	100.000W	150J	5.000B		30	30		
M5O	N	S	SEI	605	T	3	300	4.0	5.000A	100.000W	150J	5.000B		30	30		
M10A	N	S	SEI	605	T	3	50	4.0	10.000A	100.000W	150J	5.000B		30	30		
M10B	N	S	SEI	605	T	3	100	4.0	10.000A	100.000W	150J	5.000B		30	30		
M10C	N	S	SEI	605	T	3	200	4.0	10.000A	100.000W	150J	5.000B		30	30		
M100	N	S	SEI	605	T	3	300	4.0	10.000A	100.000W	150J	5.000B		30	30		
M80738	P	G	TOS	120	T	1	18	12.0	1.00A	.150W	85J	10.000B	100A	18V			
M8073C	P	G	TOS	120	T	1	18	12.0	1.00A	.150W	85J	4.000B	100A	18V	48	.024A	
M9010	N	S	TOS	45	98	20			.050A	.200W	125J	1200.000G	500NA	20V			
MA100	P	G	MOT	210	T	5	60	60S	15.0	.500A	.200W	100J	1.000B	1000A	60V	60	.010A
MA200	P	G	MOT	210	T	5	105	105	10.0	.200A	.150W	100J	1.000B	500A	105V	40	.005A
MA201	P	G	MOT	210	T	5	105	105	20.0	.200A	.150W	100J	1.000B	500A	105V	80	.005A
MA202	P	G	MOT	210	T	5	105	105	20.0	.200A	.150W	100J	1.000B	500A	105V	80	.005A
MA203	P	G	MOT	210	T	5	105	105	20.0	.200A	.150W	100J	1.000B	500A	105V	80	.005A
MA204	P	G	MOT	210	T	5	90	90	20.0	.200A	.150W	100J	1.000B	500A	90V	40	.005A
MA205	P	G	MOT	210	T	5	75	75	20.0	.200A	.150W	100J	1.000B	500A	75V	40	.005A
MA206	P	G	MOT	210	T	5	60	60	10.0	.700A	.150W	100J	9.000B	500A	60V	40	.005A
MA881	P	G	MOT	210	T	5	60	60S	15.0	.500A	.200W	100J	7.50B	1000A	60V	48	.001A
MA882	P	G	MOT	210	T	5	60	60S	15.0	.500A	.200W	100J	1.000B	1000A	60V	80	.001A
MA883	P	G	MOT	210	T	5	60	60S	15.0	.500A	.200W	100J	1.250B	1000A	60V	160	.001A
MA884	P	G	MOT	210	T	5	60	60S	15.0	.500A	.200W	100J	1.750B	1000A	60V	290	.001A
MA885	P	G	MOT	210	T	5	50	50S	15.0	.500A	.200W	100J	.500B	1000A	50V	26	.001A
MA886	P	G	MOT	210	T	5	50	50S	15.0	.500A	.200W	100J	7.50B	1000A	50V	48	.001A
MA887	P	G	MOT	210	T	5	50	50S	15.0	.500A	.200W	100J	1.000B	1000A	50V	80	.001A
MA888	P	G	MOT	210	T	5	50	50S	15.0	.500A	.200W	100J	1.250B	1000A	50V	160	.001A
MA889	P	G	MOT	210	T	5	50	50S	15.0	.500A	.200W	100J	1.750B	1000A	50V	290	.001A
MA909	P	G	MOT	210	T	5	75	35.0	.200A	.150W	100J		500A	75V	40	.005A	
MA910	P	G	MOT	210	T	5	90	90	40.0	.200A	.150W	100J		500A	90V	40	.005A
MA1702	P	G	MOT	210	T	5	45	30R	30.0	.500A	.200W	100J	7.000B	100A	30V	40	.100A
MA1703	P	G	MOT	210	T	5	25	25	25.0	.500A	.200W	100J	3.000B	150A	25V	190	.100A
MA1704	P	G	MOT	210	T	5	25	25R	25.0	.500A	.200W	100J	5.000B	150A	25V	250	.100A
MA1705	P	G	MOT	210	T	5	25	25R	25.0	.500A	.200W	100J	6.000B	150A	25V	400	.100A
MA1706	P	G	MOT	210	T	5	15	15R	4.5	.500A	.200W	100J	3.000B	150A	15V	190	.100A
MA1707	P	G	MOT	210	T	5	15	15R	4.5	.500A	.200W	100J	5.000B	150A	15V	400	.100A
MA1708	P	G	MOT	210	T	5	15	15R	4.5	.500A	.200W	100J	5.000B	150A	15V	190	.100A
NCS2135	N	S	MOT	935	935A	75	60	6.0	.050A	.150W	125J	100.000G	10NA	50V	180	.001A	
NCS2136	N	S	MOT	935	935A	75	60	6.0	.050A	.150W	125J	100.000G	10NA	50V	430	.001A	
NCS2137	N	S	MOT	935	935A	60	60	5.0	.050A	.150W	125J	100.000G	20NA	50V	180	.001A	
NCS2138	N	S	MOT	935	935A	60	60	5.0	.050A	.150W	125J	100.000G	20NA	50V	440	.001A	
ME120	N	S	AMP	211	T	12	18	45	5.0	.025A	.300W	100.000G	100NA	50	50	.001A	
ME213	N	S	AMP	211	T	18	45	5.0		.300W	100.000G	100NA	50	50	.001A		
ME213A	N	S	AMP	211	T	18	45	5.0		.300W	100.000G	100NA	50	50	.001A		
ME900	N	S	AMP	210	T	18	40	20	5.0		.60W	200J	100.000G	10NA	20V	140	
ME900A	N	S	AMP	210	T	18	40	20	5.0		.60W	200J	100.000G	10NA	20V	240	
ME901	N	S	AMP	210	T	18	40	20	5.0		.360W	200J	100.000G	10NA	20V	350	
ME901A	N	S	AMP	210	T	18	40	20	5.0		.360W	200J	100.000G	10NA	20V	350	
MF3304	P	S	MOT	217	T	72	18	12	5.0		.300W	200J	700.000G	10NA	2V	60	.010A
MHT1802	P	G	MHR	405	T	36	80	60	30.0	65.000A	170.000W	110J	1.50G	5MA	60V	70	
MHT1803	P	G	MHR	405	T	36	80	60	30.0	65.000A	170.000W	110J	1.50G	5MA	60V	70	
MHT1807	P	G	MHR	405	T	36	45	30	20.0	65.000A	170.000W	110J	.050G	5MA	40V	70	
MHT1808-1810	P	G	SEE SOT1808-1810														
MHT1902	P	G	MHR	172	T	172E	80	40	30.0	65.000A	140.000W	110J	.150G	5MA	80V	70	
MHT1903	P	G	MHR	172	T	172E	60	45	30.0	65.000A	140.000W	110J	.150G	5MA	60V	70	
MHT1904	P	G	MHR	172	T	172E	40	30	20.0	65.000A	140.000W	110J	.150G	5MA	40V	70	
MHT1908-1910	P	G	SEE SOT1908-1910														
MHT2002	P	G	MHR	571	T	571A	80	60	3.0	65.000A	140.000W	110J	.150G	5MA	80V	70	
MHT2003	P	G	MHR	571	T	571A	60	45	3.0	65.000A	140.000W	110J	.150G	5MA	60V	70	
MHT2004	P	G	MHR	571	T	571A	40	30	2.0	65.000A	140.000W	110J	.150G	5MA	40V	70	
MHT2008-2010	P	G	SEE SOT2008-2010														
MHT2101	P	G	SOL	390	T	390A	10	5		150.000A	100.000W	100J	450.000G			80	1.000A
MHT2110	P	G	SOL	390	T	390A	10	5		150.000A	100.000W	100J	450.000G			80	1.000A
MHT2111	P	G	SOL	390	T	390A	10	5		175.000A	100.000W	100J	450.000G			80	1.000A
MHT2112	P	G	SOL	390	T	390A	10	5		200.000A	100.000W	100J	450.000G			80	1.000A
MHT2150	P	G	SOL	390	T	390B	10	5		150.000A	100.000W	100J	450.000G			80	1.000A
MHT2151	P	G	SOL	390	T	390B	10	5		175.000A	100.000W	100J	450.000G			80	1.000A
MHT2152	P	G	SOL	390	T	390B	10	5		200.000A	100.000W	100J	450.000G			80	1.000A
MHT2205	P	G	SOL	176	T	176E	10	5	5.0	50.000A	140.000W	110J	.450G	5MA	10V	120	25.000A
MHT2305	P	G	SOL	403	T	68	10	5	5.0	65.000A	170.000W	110J	.450G	5MA	10V	120	25.000A
MHT4401	N	S	MHR	211	T	5	60	60	5.0		.800W	200J	40.000G	1UA	30V	60	
MHT4402	N	S	MHR	211	T	5	120	100	5.0		.800W	200J	40.000G	1UA	60V	60	
MHT4411	N	S	MHR	211	T	5	60	40	5.0	.600A	.800W	200J	50.000G	1UA	30V	40	
MHT4412	N	S	MHR	211	T	5	60	40	5.0	.600A	.800W	200J	50.000G	1UA	30V	80	
MHT4413	N	S	MHR	211	T												

Transistor Type No.	N P S	Manufacturer	Lead Ident	Out- line	Maximum (V)			Maximum		Max. T.(°C)	Frequency Resp.(MHz)	Leakage		Gain h _{FE} @ I _C
					V _{CE}	V _{BE}	V _{ES}	I _C	Power			I _{CEO} @ V _{CE}	I _{CEX}	
MHT 5001-5015		SEE SDT5001-5015												
MHT 5051-5056		SEE SDT5051-5056												
MHT 5501-5515		SEE SDT5501-5515												
MHT 5551-5556		SEE SDT5551-5556												
MHT 5901-5915		SEE SDT5901-5915												
MHT 5951-5956		SEE SDT5951-5956												
MHT 6001-6031		SEE SDT6001-6031												
MHT 6308-6316		SEE SDT6308-6316												
MHT 6408-6416		SEE SDT6408-6416												
MHT 7011-7019		SEE SDT7011-7019												
MHT 7201-7209		SEE SDT7201-7209												
MHT 7401-7419		SEE SDT7401-7419												
MHT7511	N-S		171	TO 8	60	40	5.0	20.000W	200J	40.000G	1UA	60V	36 5.000A	
MHT7512	N-S		171	TO 8	100	40	5.0	20.000W	200J	40.000G	1UA	60V	36 5.000A	
MHT7513	N-S		171	TO 8	100	40	5.0	20.000W	200J	40.000G	1UA	60V	36 5.000A	
MHT7514	N-S		171	TO 8	60	40	5.0	20.000W	200J	50.000G	1UA	60V	24 5.000A	
MHT7515	N-S		171	TO 8	80	60	5.0	20.000W	200J	50.000G	1UA	60V	70 5.000A	
MHT7516	N-S		171	TO 8	80	40	5.0	20.000W	200J	60.000G	1UA	60V	176 5.000A	
MHT7517	N-S		171	TO 8	80	40	5.0	20.000W	200J	60.000G	1UA	60V	176 5.000A	
MHT7518	N-S		171	TO 8	80	60	5.0	20.000W	200J	60.000G	1UA	60V	176 5.000A	
MHT7519	N-S		171	TO 8	100	80	5.0	20.000W	200J	60.000G	1UA	60V	176 5.000A	
MHT 7601-7612		SEE SDT7601-7612												
MHT 7801-7809		SEE SDT7801-7809												
MHT 7901-7910		SEE SDT7901-7910												
MHT 8002-8071		SEE SDT8002-8071												
MHT 8301-8304		SEE SDT8301-8304												
MHT 9001-9012		SEE SDT9001-9012												
MJ400	N S	MOT	605	TO 66	350	325	5.0	.250A	6.670W	175J	15.000G	1MA 325V	110 .050A	
MJ413	N S	MOT	605	TO 3	400	400	5.0	10.000A	125.000W	150J	6.000G	250UA 400V	40 .500A	
MJ420	N S	MOT	211	TO 5	275	250	6.0	.100A	.800W	175J	30.000G	100UA 275V	90 .030A	
MJ421	N S	MOT	605	TO 3	350	325	5.0	10.000A	125.000W	150J	30.000G	100UA 350V	90 .030A	
MJ423	N S	MOT	605	TO 3	400	400	5.0	10.000A	125.000W	150J	5.000G	250UA 400V	52 1.000A	
MJ431	N S	MOT	605	TO 3	400	400	5.0	10.000A	125.000W	150J	4.000G	3MA 400V	24 2.500A	
MJ432	N S	MOT	605	TO 3	400	400	5.0	10.000A	125.000W	150J	2.500G	24 2.500A		
MJ440	N S	MOT	605	TO 3	400	400	5.0	10.000A	125.000W	150J	3.000G	63 2.500A		
MJ450	N S	MOT	210	TO 5	40	40	4.0	150.000W	200J	2.000G	70 2.000A	70 2.000A		
MJ480	N S	MOT	605	TO 3	40	40	4.0	87.500W	200J	4.000G	80 1.000A	80 1.000A		
MJ481	N S	MOT	605	TO 3	40	40	4.0	87.500W	200J	4.000G	80 1.000A	80 1.000A		
MJ490	N S	MOT	605	TO 3	40	40	4.0	87.500W	200J	4.000G	80 1.000A	80 1.000A		
MJ491	N S	MOT	605	TO 3	40	40	4.0	87.500W	200J	4.000G	80 1.000A	80 1.000A		
MJ500	N S	MOT	561	TO 59	60	60	5.0	7.000A	60.000W	200J	30.000G	10UA 60V	70 2.000A	
MJ501	N S	MOT	561	TO 59	80	80	5.0	7.000A	60.000W	200J	30.000G	10UA 80V	70 2.000A	
MJ802	N S	MOT	605	TO 3	100	90	4.0	7.500A	200.000W	200J	2.000G	1MA 100V	50 7.500A	
MJ2249	N S	MOT	605	TO 66	80	80	6.0	2.000A	20.000W	175J	30.000G	100UA 80V	87 .030A	
MJ2250	N S	MOT	605	TO 66	80	80	6.0	2.000A	20.000W	175J	30.000G	100UA 80V	87 .030A	
MJ2251	N S	MOT	605	TO 66	225	6.0	5.00A	10.000W	150J	10.000G	100UA 225V	76 .050A		
MJ2252	N S	MOT	605	TO 66	300	6.0	5.00A	10.000W	150J	10.000G	100UA 300V	76 .050A		
MJ2253	N S	MOT	605	TO 66	70	60	7.0	4.000A	25.000W	200J	3.000G	1MA 70V	46 .250A	
MJ2254	N S	MOT	605	TO 66	90	80	7.0	4.000A	25.000W	200J	3.000G	1MA 90V	46 .250A	
MJ2267	N S	MOT	605	TO 3	40	40	7.0	10.000A	150.000W	200J	3.000G	1MA 40V	32 3.000A	
MJ2268	N S	MOT	605	TO 3	55	55	7.0	10.000A	150.000W	200J	3.000G	1MA 60V	32 3.000A	
MJ3029	N S	MOT	605	TO 3	500R	5.0	3.500A	125.000W	150J	AUD	1MA 500V	6 3.000A		
MJ3030	N S	MOT	605	TO 3	700X	5.0	3.500A	125.000W	150J	AUD	2MA 700V	45 .400A		
MJ3101	N S	MOT	605	TO 66	50	40	6.0	2.000A	20.000W	175J	30.000G	100UA 50V	87 .030A	
MJ3201	N S	MOT	605	TO 66	225	225	3.0	.100A	15.000W	175J	15.000G	100UA 225V	80 .050A	
MJ3202	N S	MOT	605	TO 66	300	300	3.0	.100A	15.000W	175J	15.000G	100UA 300V	80 .050A	
MJ3701	N S	MOT	605	TO 66	50	40	5.0	4.000A	25.000W	200J	3.000G	1MA 50V	46 .250A	
MJ3772	N S	MOT	605	TO 3	50	40	5.0	30.000A	150.000W	200J	2.000G	2MA 50V	30 15.000A	
MJ4502	N S	MOT	605	TO 3	100	90	4.0	30.000A	200.000W	200J	2.000G	5MA 100V	30 10.000A	
MJ6700	N S	MOT	560	TO 59	60	60	5.0	7.000A	60.000W	200J	30.000G	10UA 60V	70 2.000A	
MJ6701	N S	MOT	560	TO 59	80	80	5.0	7.000A	60.000W	200J	30.000G	10UA 80V	70 2.000A	
MJ7000	N S	MOT	561	TO 63	100	100	6.0	30.000A	150.000W	200J	20.000G	100UA 100V	45 20.000A	
MJ7200	N S	MOT	563	TO 114	100	80	6.0	60.000A	300.000W	200J	20.000G	100UA 100V	45 20.000A	
MJ7201	N S	MOT	563	TO 114	120	100	6.0	60.000A	300.000W	200J	20.000G	100UA 120V	45 20.000A	
MJ8100	N S	MOT	210	TO 39	60	80	5.0	5.000A	10.000W	200J	30.000G	10UA 60V	70 2.000A	
MJ8101	N S	MOT	210	TO 39	60	80	5.0	5.000A	10.000W	200J	30.000G	10UA 80V	70 2.000A	
MJE105	N S	MOT	48	48B	50	50	4.0	5.000A	65.000W	150J	AUD	100UA 50V	50 2.000A	
MJE205	N S	MOT	48	48B	50	50	4.0	5.000A	65.000W	150J	AUD	100UA 50V	50 2.000A	
MJE340	N S	MOT	48	48A	30	30	3.0	500A	20.800W	150J	AUD	100UA 300V	90 .050A	
MJE370	N S	MOT	48	48A	30	30	4.0	3.000A	25.000W	150J	AUD	100UA 30V	38 1.000A	
MJE371	N S	MOT	48	48A	40	40	4.0	3.000A	40.000W	150J	AUD	100UA 40V	60 1.000A	
MJE520	N S	MOT	48	48A	30	30	4.0	3.000A	25.000W	150J	AUD	100UA 30V	60 1.000A	
MJE521	N S	MOT	48	48A	40	40	4.0	3.000A	40.000W	150J	AUD	100UA 40V	60 1.000A	
MJE2801	N S	MOT	48	48B	60	60	4.0	10.000A	90.000W	150J	AUD	100UA 60V	50 3.000A	
MJE2901	N S	MOT	48	48B	60	60	4.0	10.000A	90.000W	150J	AUD	100UA 60V	50 3.000A	
MJE2955	N S	MOT	48	48B	70	60	5.0	10.000A	90.000W	150J	2.000G	1MA 70V	38 4.000A	
MJE3055	N S	MOT	48	48B	70	60	5.0	10.000A	90.000W	150J	2.000G	1MA 70V	37 4.000A	
MM380	P G	MOT	211	TO 18	25	10	.3	.100A	.250W	100J	400.000G	10UA 10V	50 .003A	
MM709	P G	MOT	217	TO 52	15	8	4.0	.100A	.400W	200J	300.000G	15NA 5V	45 .010A	
MM1139	P G	MOT	217	TO 72	30	15	.3	.200A	1.25W	100J	400.000G	8UA 20V	24 .002A	
MM1500	N S	MOT	120	120H	30	15	4.0	.200A	3.500W	200J	1500.000G	100NA 20V		
MM1501	N S	MOT	120	120H	30	15	4.0	.200A	3.500W	200J	1000.000G	100NA 20V		
MM1549		SEE RF POWER SECTION												
MM1550		SEE RF POWER SECTION												
MM1551		SEE RF POWER SECTION												
MM1557		SEE RF POWER SECTION												
MM1558		SEE RF POWER SECTION												
MM1559		SEE RF POWER SECTION												
MM1601		SEE 2N5589												
MM1602		SEE 2N5590												

Transistor Type No.	N P S	Manufacturer	Lead Ident	Out- line	Maximum (V)			Maximum		Max. T.(°C)	Frequency Resp.(MHz)	Leakage		Gain h _{FE} @ I _C
					V _{CE}	V _{ES}	V _{EB}	I _C	Power			I _{CEO}	I _{ES}	
MM1603	S	SEE RF POWER SECTION												
MM1748	N	MOT	211	To 52	15	6	4.0	.100A	.300W	200J	600.000G	50NA 5V	50 .010A	
MM1941	N	MOT	210	To 18	30	30S	3.0	.200A	.300W	175J	600.000G	100NA 15V	50 .010A	
MM1943	N	MOT	210	To 18	40	40S	3.0	.200A	.300W	175J	500.000G	100NA 15V	50 .010A	
MM2258	N	MOT	211	To 5	120	120	5.0	.500A	1.000W	200J	150.000G	50NA 75V	100 .010A	
MM2259	N	MOT	211	To 5	175	175	5.0	.300A	1.000W	200J	150.000G	50NA 75V	100 .010A	
MM2260	N	MOT	211	To 5	175	175	5.0	.300A	1.000W	200J	150.000G	50NA 75V	100 .010A	
MM2264	N	MOT	211	To 5	175	175	5.0	1.500A	1.100W	200J	50.000G	500NA 25V	140 .010A	
MM2483	N	MOT	211	To 18	60	60	6.0	.050A	.360W	200J	600.000G	10NA 45V	70 .001A	
MM2484	N	MOT	211	To 18	60	60	6.0	.050A	.360W	200J	600.000G	10NA 45V	225 .001A	
MM2894	N	MOT	211	To 18	15	12	4.5	.360W	.360W	200J	400.000G	10NA 45V	70 .001A	
MM3000	N	MOT	210	To 39	100	5.0		400A	1.000W	200J	150.000G	1UA 50V	30 .010A	
MM3001	N	MOT	210	To 39	150	5.0		400A	1.000W	200J	150.000G	1UA 75V	30 .010A	
MM3002	N	MOT	210	To 39	200	5.0		400A	1.000W	200J	150.000G	5UA 100V	30 .010A	
MM3003	N	MOT	210	To 39	250	5.0		400A	1.000W	200J	150.000G	5UA 100V	30 .010A	
MM3008	N	MOT	210	To 39	120	6.0		400A	1.000W	200J	50.000G	100NA 180V	60 .010A	
MM3009	N	MOT	210	To 39	180	6.0		400A	1.000W	200J	12.000G	100NA 120V	60 .010A	
MM3724	N	MOT	211	To 5	40	30	6.0	1.500A	1.000W	200J	200.000G	500NA 40V	62 .500A	
MM3725	N	MOT	211	To 5	50	6.0		1.500A	1.000W	200J	200.000G	500NA 40V	62 .500A	
MM3726	P	MOT	211	To 5	60	50	5.0	1.500A	1.000W	200J	200.000G	100NA 40V	60 .500A	
MM3903	N	MOT	210	To 52	60	40	6.0	.200A	.360W	200J	300.000G	50NA 30V	175 .010A	
MM3904	N	MOT	210	To 52	60	40	6.0	.200A	.360W	200J	300.000G	50NA 30V	88 .010A	
MM3905	N	MOT	210	To 52	40	40	5.0	.200A	.360W	200J	200.000G	50NA 30V	88 .010A	
MM3906	P	MOT	210	To 52	40	40	5.0	.200A	.360W	200J	250.000G	50NA 30V	175 .010A	
MM4000	P	MOT	211	To 39	100	100	4.0	.100A	.600W	200J	1.000G	1UA 50V	30 .010A	
MM4001	P	MOT	211	To 39	150	150	4.0	.500A	1.000W	200J	1.000G	1UA 100V	30 .010A	
MM4002	P	MOT	211	To 39	250	250	4.0	.500A	1.000W	200J	1.000G	5UA 100V	30 .010A	
MM4003	P	MOT	211	To 39	250	250	4.0	.500A	1.000W	200J	1.000G	10NA 30V	260 .001A	
MM4048	P	MOT	210	To 46	30	30	30.0	.500A	.500W	200J	12.000G	1MA 15V	23 .010A	
MM4052	P	MOT	210	To 46	30	30	30.0	.500A	.500W	200J	12.000G	5NA 10V	68 .010A	
MM4261H	P	MOT	217	To 72	15	15	4.5	.030A	.20W	200J	1500.000G			
MM4429		SEE RF POWER SECTION												
MM4430		SEE RF POWER SECTION												
MM5000	P	MOT	217	To 72	30	15	.3	.010A	.150W	100J	800.000G		60 .003A	
MM5001	P	MOT	217	To 72	30	15	.3	.010A	.150W	100J	800.000G		60 .003A	
MM5002	P	MOT	210	To 39	40	30	3.5	.400A	3.500W	200J	1000.000G	20UA 28V	45 .050A	
MM8000	N	MOT	210	To 39	40	30	3.5	.400A	3.500W	200J	1000.000G	20UA 28V	45 .050A	
MM8001	N	MOT	210	To 39	40	30	3.5	.400A	3.500W	200J	1000.000G	20UA 28V	45 .050A	
MM8002	N	MOT	210	To 39	40	30	3.5	.400A	3.500W	200J	1000.000G	20UA 28V	45 .050A	
MM8003	N	MOT	962	962C	40	30	3.5	.400A	5.000W	200J	1000.000G	10NA 6V	38 .001A	
MM8006	N	MOT	217	To 72	15	10	3.0	.020A	.200W	200J	1000.000G	10NA 6V	38 .001A	
MM8007	N	MOT	217	To 72	15	10	3.0	.020A	.200W	200J	1000.000G	10NA 6V	38 .001A	
MM8008	N	MOT	120	T0107	35	30	3.0	.100A	3.500W	200J	1100.000G	100UA 20V		
MM8009	N	MOT	210	To 39	55	50	3.0	.400A	3.500W	200J	1000.000G	100UA 15V		
MM8010	N	MOT	120	T0107	35	30	3.0	.100A	3.500W	200J	1100.000G	100UA 20V		
MM8011	N	MOT	120	T0107	35	30	3.0	.100A	3.500W	200J	1100.000G	100UA 20V		
MM1918	N	MOT	916	916A	30	15	3.0	.050A	.225W	135J	600.000G	10NA 15V	30 .003A	
MM1930	N	MOT	916	916A	60	45	6.0	.050A	.225W	135J	600.000G	10NA 45V	225 .001A	
MM12222	N	MOT	916	916A	60	30	5.0	.200A	.225W	135J	200.000G	50NA 50V	175 .150A	
MM12369	N	MOT	916	916A	60	60	6.0	.050A	.225W	135J	500.000G	100NA 20V	70 .010A	
MM12484	N	MOT	916	916A	60	30	5.0	.040A	.225W	135J	1000.000G	50NA 15V	45 .030A	
MM12857	N	MOT	916	916A	60	40	5.0	.040A	.225W	135J	200.000G	50NA 15V	175 .150A	
MM12907	N	MOT	916	916A	60	40	5.0	.040A	.225W	135J	200.000G	50NA 15V	175 .150A	
MM13014	N	MOT	916	916A	60	40	5.0	.040A	.225W	135J	200.000G	50NA 15V	175 .150A	
MM13546	P	MOT	916	916A	15	12	4.5	.25A	.225W	135J	350.000G	100NA 20V	100 .030A	
MM13798	P	MOT	916	916A	60	60	6.0	.050A	.225W	135J	40.000G	50NA 50V	260 .001A	
MM13799	P	MOT	916	916A	60	60	6.0	.050A	.225W	135J	40.000G	50NA 50V	525 .001A	
MM13903	N	MOT	916	916A	60	40	6.0	.200A	.225W	135J	250.000G	50NA 40V	175 .010A	
MM13904	N	MOT	916	916A	60	40	6.0	.200A	.225W	135J	300.000G	50NA 40V	175 .010A	
MM13905	N	MOT	916	916A	60	40	6.0	.200A	.225W	135J	200.000G	50NA 40V	175 .010A	
MM13906	N	MOT	916	916A	40	40	5.0	.200A	.225W	135J	250.000G	50NA 30V	88 .010A	
MM13960A	N	MOT	916	916A	15	8	3.0	.225W	135J	1600.000G	50NA 10V	80 .010A		
MM21		SEE 2N375												
MM24		SEE 2N350												
MM25		SEE 2N351												
MM26		SEE 2N376												
MM28		SEE 2N555												
MM48		SEE 2N669												
MM49		SEE 2N618												
MM61A		SEE 2N627												
MM62A		SEE 2N628												
MM63A		SEE 2N629												
MM64A		SEE 2N630												
MP110	P	MOT	605	To 3			65X	7.000A	106.000W	110J	.320G	2MA 40V	136 1.000A	
MP110B-BLU	P	MOT	605	To 3	90	40	2.0	25.000A	106.000W	110J	.500G	20MA 90V	225 1.000A	
MP110B-GRN	P	MOT	605	To 3	90	40	2.0	25.000A	106.000W	110J	.500G	20MA 90V	150 1.000A	
MP110B-REO	P	MOT	605	To 3	90	40	2.0	25.000A	106.000W	110J	.500G	20MA 90V	95 1.000A	
MP500	P	MOT	405	To 36	45	30	25.0	60.000A	170.000W	110J	.002E	4MA 45V	46 15.000A	
MP500A	P	MOT	405	To 36	45	30	25.0	60.000A	170.000W	110J	.002E	4MA 45V	46 15.000A	
MP501	P	MOT	405	To 36	60	45	30.0	60.000A	170.000W	110J	.002E	4MA 60V	46 15.000A	
MP501A	P	MOT	405	To 36	60	45	30.0	60.000A	170.000W	110J	.002E	4MA 60V	46 15.000A	
MP502	P	MOT	405	To 36	75	60	40.0	60.000A	170.000W	110J	.002E	4MA 75V	46 15.000A	
MP502A	P	MOT	405	To 36	75	60	40.0	60.000A	170.000W	110J	.002E	4MA 75V	46 15.000A	
MP504	P	MOT	405	To 36	45	30	25.0	60.000A	170.000W	110J	.002E	4MA 45V	46 15.000A	
MP504A	P	MOT	405	To 36	45	30	25.0	60.000A	170.000W	110J	.002E	4MA 45V	46 15.000A	
MP505	P	MOT	405	To 36	60	45	30.0	60.000A	170.000W	110J	.002E	4MA 60V	62 15.000A	
MP505A	P	MOT	405	To 36	60	45	30.0	60.000A	170.000W	110J	.002E	4MA 60V	62 15.000A	
MP506	P	MOT	405	To 36	75	60	40.0	60.000A	170.000W	110J	.002E	4MA 75V	62 15.000A	
MP506A	P	MOT	405	To 36	75	60	40.0</							

Transistor Type No.	N P S	R P G	S MOT	Manufacturer	Lead Ident	Out- line	Maximum (V)			Maximum		Max. T.(°C)	Frequency Resp.(MHz)	Leakage		Gain
							V _{ce}	V _{ce}	V _{ce}	I _c	Power			I _{ce} @ V _{ce}	h _{FE} @ I _c	
MP1543	P	G	MOT		607	To 41	120	60	12.0	5.000A	90.000W	100J	.150G	2MA	80V	75
MP1544A	P	G	MOT		607	To 41	40	20	20.0	5.000A	90.000W	100J	.040E	2MA	25V	100 3.000A
MP1545A	P	G	MOT		607	To 41	60	30	30.0	5.000A	90.000W	100J	.040E	2MA	40V	100 3.000A
MP1546A	P	G	MOT		607	To 41	80	40	40.0	5.000A	90.000W	100J	.040E	2MA	40V	100 3.000A
MP1547A	P	G	MOT		607	To 41	100	50	50.0	5.000A	90.000W	100J	.040E	2MA	50V	100 3.000A
MP1534A	P	G	MOT		607	To 41	40	20	20.0	5.000A	106.000W	110J	.040E	2MA	25V	52 3.000A
MP1535	P	G	MOT		607	To 41	60	30	30.0	5.000A	90.000W	100J	.040E	2MA	40V	52 3.000A
MP1535A	P	G	MOT		607	To 41	80	40	40.0	5.000A	90.000W	100J	.040E	2MA	40V	52 3.000A
MP1536	P	G	MOT		607	To 41	80	40	40.0	5.000A	106.000W	110J	.040E	2MA	40V	52 3.000A
MP1536A	P	G	MOT		607	To 41	80	40	40.0	5.000A	106.000W	110J	.040E	2MA	55V	52 3.000A
MP1537	P	G	MOT		607	To 41	100	50	50.0	5.000A	90.000W	100J	.040E	2MA	65V	52 3.000A
MP1537A	P	G	MOT		607	To 41	100	50	50.0	5.000A	106.000W	110J	.040E	2MA	65V	52 3.000A
MP1538	P	G	MOT		607	To 41	120	60	60.0	5.000A	90.000W	100J	.040E	2MA	80V	52 3.000A
MP1539A	P	G	MOT		607	To 41	40	20	20.0	5.000A	90.000W	100J	.040E	2MA	80V	52 3.000A
MP1540A	P	G	MOT		607	To 41	60	30	30.0	5.000A	90.000W	100J	.040E	2MA	25V	74 3.000A
MP1541A	P	G	MOT		607	To 41	80	40	40.0	5.000A	90.000W	100J	.040E	2MA	55V	74 3.000A
MP1542A	P	G	MOT		607	To 41	100	50	50.0	5.000A	90.000W	100J	.040E	2MA	65V	74 3.000A
MP1548	P	G	MOT		607	To 41	80	40	40.0	5.000A	90.000W	100J	.040E	2MA	65V	74 3.000A
MP1549	P	G	MOT		607	To 41	40	20	20.0	5.000A	90.000W	100J	.040E	2MA	80V	110 3.000A
MP1549A	P	G	MOT		607	To 41	40	20	20.0	15.000A	90.000W	100J	.010E	3MA	25V	20 10.000A
MP1550	P	G	MOT		607	To 41	60	30	30.0	15.000A	90.000W	100J	.010E	3MA	40V	20 10.000A
MP1550A	P	G	MOT		607	To 41	60	30	30.0	15.000A	90.000W	100J	.010E	3MA	40V	20 10.000A
MP1551	P	G	MOT		607	To 41	80	40	40.0	15.000A	90.000W	100J	.010E	3MA	55V	20 10.000A
MP1551A	P	G	MOT		607	To 41	80	40	40.0	15.000A	90.000W	100J	.010E	3MA	55V	20 10.000A
MP1552	P	G	MOT		607	To 41	100	50	50.0	15.000A	90.000W	100J	.010E	3MA	65V	20 10.000A
MP1552A	P	G	MOT		607	To 41	100	50	50.0	15.000A	90.000W	100J	.010E	3MA	65V	20 10.000A
MP1553	P	G	MOT		607	To 41	40	20	20.0	15.000A	90.000W	100J	.006E	3MA	25V	44 10.000A
MP1553A	P	G	MOT		607	To 41	40	20	20.0	15.000A	90.000W	100J	.006E	3MA	25V	44 10.000A
MP1554	P	G	MOT		607	To 41	60	30	30.0	15.000A	90.000W	100J	.006E	3MA	40V	44 10.000A
MP1554A	P	G	MOT		607	To 41	60	30	30.0	15.000A	90.000W	100J	.006E	3MA	40V	44 10.000A
MP1555	P	G	MOT		607	To 41	80	40	40.0	15.000A	90.000W	100J	.006E	3MA	55V	44 10.000A
MP1555A	P	G	MOT		607	To 41	80	40	40.0	15.000A	90.000W	100J	.006E	3MA	55V	44 10.000A
MP1556	P	G	MOT		607	To 41	100	50	50.0	15.000A	90.000W	100J	.006E	3MA	65V	44 10.000A
MP1556A	P	G	MOT		607	To 41	100	50	50.0	15.000A	90.000W	100J	.006E	3MA	65V	44 10.000A
MP1557	P	G	MOT		607	To 41	40	20	20.0	15.000A	90.000W	100J	.006E	3MA	25V	74 10.000A
MP1557A	P	G	MOT		607	To 41	40	20	20.0	15.000A	90.000W	100J	.006E	3MA	25V	74 10.000A
MP1558	P	G	MOT		607	To 41	60	30	30.0	15.000A	90.000W	100J	.005E	3MA	40V	70 10.000A
MP1558A	P	G	MOT		607	To 41	60	30	30.0	15.000A	90.000W	100J	.005E	3MA	40V	70 10.000A
MP1559	P	G	MOT		607	To 41	80	40	40.0	15.000A	90.000W	100J	.005E	3MA	55V	70 10.000A
MP1559A	P	G	MOT		607	To 41	80	40	40.0	15.000A	90.000W	100J	.005E	3MA	55V	70 10.000A
MP1560	P	G	MOT		607	To 41	100	50	50.0	15.000A	90.000W	100J	.005E	3MA	65V	70 10.000A
MP1560A	P	G	MOT		607	To 41	100	50	50.0	15.000A	90.000W	100J	.005E	3MA	65V	70 10.000A
MP1612	P	G	MOT		605	To 3	100	50	50.0	25.000A	85.000W	200J	.005E	5MA	100V	50 10.000A
MP1612A	P	G	MOT		605	To 3	140	75	2.5	20.000A	85.000W	110J	HOR AMP	10MA	120V	50 10.000A
MP1612B	P	G	MOT		605	To 3	160	100	2.5	20.000A	85.000W	110J	HOR AMP	10MA	120V	50 10.000A
MP1613	P	G	MOT		605	To 3	100	50	50.0	7.000A	85.000W	110C	HOR AMP	5MA	100V	120 .050A
MP2000A	P	G	MOT		605	To 3	40	20	20.0	25.000A	106.000W	110J	.210G	10MA	60V	37 8.000A
MP2060	P	G	MOT		605	To 3	75	50	20.0	7.000A	85.000W	110C	.300G	1MA	25V	80 3.000A
MP2061	P	G	MOT		605	To 3	75	50	20.0	7.000A	85.000W	110C	.300G	1MA	40V	80 3.000A
MP2062	P	G	MOT		605	To 3	60	20	20.0	7.000A	85.000W	110C	.300G	1MA	60V	80 3.000A
MP2063	P	G	MOT		605	To 3	30	20	20.0	25.000A	106.000W	110C	.210G	10MA	60V	37 8.000A
MP2100A	P	G	MOT		607	To 41	45	30	25.0	70.000W	110J	.020E	50UA	2V	22 2.000A	
MP2137A	P	G	MOT		607	To 41	60	45	30.0	70.000W	110J	.020E	50UA	2V	22 2.000A	
MP2138A	P	G	MOT		607	To 41	75	60	40.0	70.000W	110J	.020E	50UA	2V	22 2.000A	
MP2139A	P	G	MOT		607	To 41	90	65	40.0	70.000W	110J	.020E	50UA	2V	22 2.000A	
MP2140A	P	G	MOT		607	To 41	30	20	15.0	70.000W	110J	.020E	50UA	2V	33 2.000A	
MP2141A	P	G	MOT		607	To 41	45	30	25.0	70.000W	110J	.020E	50UA	2V	33 2.000A	
MP2142A	P	G	MOT		607	To 41	60	45	30.0	70.000W	110J	.020E	50UA	2V	33 2.000A	
MP2143A	P	G	MOT		607	To 41	75	60	40.0	70.000W	110J	.020E	50UA	2V	33 2.000A	
MP2144A	P	G	MOT		607	To 41	90	65	40.0	70.000W	110J	.020E	50UA	2V	33 2.000A	
MP2145A	P	G	MOT		607	To 41	30	20	15.0	70.000W	110J	.020E	50UA	2V	33 2.000A	
MP2146A	P	G	MOT		607	To 41	45	30	25.0	70.000W	110J	.020E	50UA	2V	33 2.000A	
MP2200A	P	G	MOT		605	To 3	80	20	2.5	25.000A	106.000W	110J	.210G	10MA	60V	37 8.000A
MP2300A	P	G	MOT		605	To 3	120	20	2.5	25.000A	106.000W	110J	.210G	10MA	120V	37 8.000A
MP2400A	P	G	MOT		605	To 3	100	20	2.5	25.000A	106.000W	110J	.210G	10MA	140V	37 8.000A
MP2526	P	G	MOT		607	To 41	80	60	5.0	10.000A	56.000W	110J	.1000G	5MA	200V	65 2.250A
MP2527	P	G	MOT		607	To 41	120	60	5.0	10.000A	56.000W	110J	.1000G	5MA	320V	65 6.000A
MP2528	P	G	MOT		607	To 41	160	160	5.0	10.000A	85.000W	110J	.101E	3MA	120V	36 3.000A
MP2832	P	G	MOT		607	To 41	80	50	2.0	20.000A	85.000W	110J	.350G	10MA	80V	75 .000A
MP2833	P	G	MOT		607	To 41	120	75	2.0	20.000A	85.000W	110J	10.000G	10MA	120V	75 .000A
MP2834	P	G	MOT		607	To 41	140	100	2.0	20.000A	85.000W	110J	10.000G	10MA	120V	75 .000A
MP3611	P	G	MOT		607	To 41	40	25	20.0	7.000A	85.000W	110J	.300G	5MA	40V	50 3.000A
MP3612	P	G	MOT		607	To 41	60	35	30.0	7.000A	85.000W	110J	.300G	5MA	60V	50 3.000A
MP3613	P	G	MOT		607	To 41	80	45	40.0	7.000A	85.000W	110J	.300G	5MA	80V	50 3.000A
MP3614	P	G	MOT		607	To 41	100	60	50.0	7.000A	85.000W	110J	.300G	5MA	100V	50 3.000A
MP3615	P	G	MOT		607	To 41	120	75	50.0	7.000A	85.000W	110J	.300G	5MA	120V	50 3.000A
MP3616	P	G	MOT		607	To 41	40	25	20.0	7.000A	85.000W	110J	.300G	5MA	40V	80 3.000A
MP3617	P	G	MOT		607	To 41	60	35	30.0	7.000A	85.000W	110J	.300G	5MA	60V	80 3.000A
MP3618	P	G	MOT		607	To 41	80	50	40.0	7.000A	85.000W	110J	.300G	5MA	80V	60 3.000A
MP3730	P	G	MOT		605	To 3	200	200	2.0	10.000A	56.000W	110J	1.000G	5MA	200V	65 2.250A
MP3731	P	G	MOT		605	To 3	320	320	2.0	10.000A	56.000W	110J	1.000G	5MA	320V	65 6.000A
MP5435	P	G	MOT		605	To 41	80	60	2.5	60.000A	120.000W	110J	.350G	10MA	140V	35 25.000A
MP5436	P	G	MOT		605	To 41	110	90	2.5	60.000A	120.000W	110J	.350G	10MA	140V	35 25.000A
MP5437	P	G	MOT		605	To 41	140	120	2.5							

Transistor Type No.	N P	G S	Manufacturer	Lead Ident	Out- line	Maximum (V)			Maximum Power		Max. T _c (°C)	Frequency Resp.(MHz)	Leakage		Gain	
						V _{CE}	V _{BE}	V _{ES}	I _c	P			I _{CEO}	V _{CE}	h _{FE} @ I _c	
MPS3393	N	S	MOT	41	T0 92	25	25	5.0	100A	310W	135J	AUD	100NA	18V	190	.002A
MPS3394	N	S	MOT	41	T0 92	25	25	5.0	100A	310W	135J	AUD	100NA	18V	130	.002A
MPS3395	N	S	MOT	41	T0 92	25	25	5.0	100A	310W	135J	AUD	100NA	18V	350	.002A
MPS3563	N	S	MOT	41	T0 92	30	12	2.0		310W	135J	600.000G	50NA	15V	0	.080A
MPS3638	N	S	MOT	41	T0 92	25	25	4.0	500A	310W	135J	150.000G	35NA	15V	60	.050A
MPS3638A	P	S	MOT	41	T0 92	6	6	4.0	080A	200W	125J	500.000G	10NA	3V	60	.050A
MPS3639	N	S	MOT	41	T0 92	12	12	4.0	080A	310W	135J	500.000G	10NA	6V	60	.010A
MPS3646	N	S	MOT	41	T0 92	40	15	5.0	200A	310W	135J	200.000G	500NA	20V	60	.030A
MPS3693	N	S	MOT	41	T0 92	45	45	4.0		310W	135J	200.000G	50NA	35V	80	.010A
MPS3694	N	S	MOT	41	T0 92	40	25	5.0	200A	310W	135J	100.000G	100NA	20V	130	.050A
MPS3702	N	S	MOT	41	T0 92	50	30	5.0	200A	310W	135J	100.000G	100NA	20V	68	.050A
MPS3703	N	S	MOT	41	T0 92	50	30	5.0	200A	310W	135J	100.000G	100NA	20V	180	.050A
MPS3704	N	S	MOT	41	T0 92	50	30	5.0	600A	310W	135J	100.000G	100NA	20V	88	.050A
MPS3705	N	S	MOT	41	T0 92	40	20	5.0	600A	310W	135J	100.000G	100NA	20V	180	.050A
MPS3706	N	S	MOT	41	T0 92	30	30	6.0	030A	310W	135J	AUD	100NA	20V	210	.001A
MPS3708	N	S	MOT	41	T0 92	30	30	6.0	030A	310W	135J	AUD	100NA	20V	86	.001A
MPS3709	N	S	MOT	41	T0 92	30	30	6.0	030A	310W	135J	AUD	100NA	20V	172	.001A
MPS3710	N	S	MOT	41	T0 92	30	30	6.0	030A	310W	135J	200.000G	100NA	20V	345	.01A
MPS3826	N	S	MOT	41	T0 92	60	45	4.0	030A	310W	135J	200.000G	100NA	30V	200	.010A
MPS3827	N	S	MOT	41	T0 92	65	25	5.0	100A	210W	135J	120.000G	100NA	25V	225	.010A
MPS5172	N	S	MOT	41	T0 92	30	20	3.0	100A	310W	135J	700.000G	50NA	15V	50	.002A
MPS5607	N	S	MOT	41	T0 92	30	20	3.0	100A	310W	135J	200.000G	50NA	15V	50	.002A
MPS5611	N	S	MOT	41	T0 92	40	30	4.0	100A	310W	135J	250.000G	50NA	30V	130	.002A
MPS5612	N	S	MOT	41	T0 92	40	30	4.0	100A	310W	135J	390.000G	50NA	30V	270	.002A
MPS5613	N	S	MOT	41	T0 92	40	25	4.0	100A	310W	135J	390.000G	50NA	30V	370	.002A
MPS5614	N	S	MOT	41	T0 92	40	25	4.0	100A	310W	135J	390.000G	50NA	30V	75	.002A
MPS5615	N	S	MOT	41	T0 92	40	25	4.0	100A	310W	135J	200.000G	50NA	30V	135	.002A
MPS5617	N	S	MOT	41	T0 92	40	25	4.0	100A	310W	135J	340.000G	50NA	30V	225	.002A
MPS5618	N	S	MOT	41	T0 92	40	25	4.0	100A	310W	135J	480.000G	50NA	30V	375	.002A
MPS5619	N	S	MOT	41	T0 92	25	25	4.0	100A	310W	135J	480.000G	50NA	30V	300	.002A
MPS5620	N	S	MOT	41	T0 92	40	25	4.0	100A	310W	135J	420.000G	50NA	20V	450	.002A
MPS5621	N	S	MOT	41	T0 92	40	25	4.0	100A	310W	135J	420.000G	50NA	20V	450	.002A
MPS5622	N	S	MOT	41	T0 92	25	25	4.0	100A	310W	135J	390.000G	50NA	40V	100	.100A
MPS5630	N	S	MOT	41	T0 92	60	40	5.0	600A	310W	135J	390.000G	50NA	40V	100	.100A
MPS5631	N	S	MOT	41	T0 92	60	40	5.0	600A	310W	135J	390.000G	100NA	30V	45	.100A
MPS5632	N	S	MOT	41	T0 92	50	40	4.0	600A	310W	135J	260.000G	50NA	30V	85	.100A
MPS5633	N	S	MOT	41	T0 92	40	40	4.0	600A	310W	135J	260.000G	50NA	30V	100	.100A
MPS5634	N	S	MOT	41	T0 92	30	30	4.0	600A	310W	135J	260.000G	100NA	25V	38	.002A
MPS5635	N	S	MOT	42	T0 92	30	20	3.0	100A	310W	135J	700.000G	100NA	25V	38	.002A
MPS5640	N	S	MOT	42	T0 92	35	25	3.0	100A	310W	135J	750.000G	100NA	25V	38	.004A
MPS5642	N	S	MOT	42	T0 92	60	45	4.0	050A	310W	135J	600.000G	100NA	25V	30	.002A
MPS5643	N	S	MOT	42	T0 92	35	35	3.0	050A	310W	135J	650.000G	100NA	25V	38	.004A
MPS5644	N	S	MOT	42	T0 92	30	25	3.0	600A	500W	135J	60.000G	100NA	20V	100	.500A
MPS5645	N	S	MOT	41	T0 92	20	20	4.0	600A	500W	135J	60.000G	100NA	20V	100	.500A
MPS5646	N	S	MOT	41	T0 92	25	25	4.0	600A	500W	135J	60.000G	100NA	20V	100	.500A
MPS5647	N	S	MOT	41	T0 92	20	20	4.0	600A	500W	135J	200.000G	100NA	30V	80	.010A
MPS5648	N	S	MOT	41	T0 92	60	45	4.0	200A	310W	135J	200.000G	50NA	30V	38	.010A
MPS5649	N	S	MOT	42	T0 92	40	40	5.0	200A	310W	135J	375.000G	50NA	10V	70	.004A
MPS5656	N	S	MOT	42	T0 92	20	20	3.0	310W	135J	135J	375.000G	50NA	10V	70	.004A
MPS5658	N	S	MOT	42	T0 92	20	20	3.0	310W	135J	135J	300.000G	50NA	10V	70	.004A
MPS5658A	N	S	MOT	42	T0 92	20	20	3.0	310W	135J	135J	300.000G	50NA	10V	70	.004A
MPS5659	N	S	MOT	42	T0 92	20	20	3.0	310W	135J	135J	50.000G	100NA	20V	500	.001A
MPS5670	N	S	MOT	41	T0 92	20	20	3.0	310W	135J	135J	250.000G	100NA	20V	30	.002A
MPS5671	N	S	MOT	41	T0 92	100	80	4.0	250A	310W	135J	60.000G	100NA	50V	60	.010A
MPS5680	N	S	MOT	41	T0 92	60	50	4.0	250A	310W	135J	60.000G	100NA	50V	88	.010A
MPS5691	N	S	MOT	41	T0 92	50	50	4.0	500A	500W	135J	50.000G	100NA	80V	88	.100A
MPSA05	N	S	MOT	41	T0 92	50	50	4.0	050A	310W	135J	30.000G	100NA	25V	250	.001A
MPSA06	N	S	MOT	41	T0 92	50	50	4.0	050A	310W	135J	30.000G	100NA	25V	250	.001A
MPSA09	N	S	MOT	41	T0 92	40	40	4.0	100A	300W	135J	50.000G	100NA	30V	150	.005A
MPSA10-BLU	N	S	MOT	41	T0 92	40	40	4.0	100A	300W	135J	50.000G	100NA	30V	60	.005A
MPSA10-GRN	N	S	MOT	41	T0 92	40	40	4.0	100A	300W	135J	50.000G	100NA	30V	120	.005A
MPSA10-RED	N	S	MOT	41	T0 92	40	40	4.0	100A	300W	135J	50.000G	100NA	30V	120	.005A
MPSA10-WHT	N	S	MOT	41	T0 92	40	40	4.0	100A	300W	135J	50.000G	100NA	30V	225	.005A
MPSA10-YEL	N	S	MOT	41	T0 92	40	40	4.0	100A	300W	135J	125.000G	100NA	30V	195	.005A
MPSA20-BLU	N	S	MOT	41	T0 92	40	40	4.0	100A	300W	135J	125.000G	100NA	30V	150	.005A
MPSA20-GRN	N	S	MOT	41	T0 92	40	40	4.0	100A	300W	135J	125.000G	100NA	30V	60	.005A
MPSA20-REO	N	S	MOT	41	T0 92	40	40	4.0	100A	300W	135J	125.000G	100NA	30V	120	.005A
MPSA20-WHT	N	S	MOT	41	T0 92	40	40	4.0	100A	300W	135J	125.000G	100NA	30V	225	.005A
MPSA20-YEL	N	S	MOT	41	T0 92	40	40	4.0	100A	300W	135J	125.000G	100NA	30V	195	.005A
MPSA55	N	S	MOT	41	T0 92	50	50	4.0	500A	500W	135J	50.000G	100NA	80V	88	.100A
MPSA56	N	S	MOT	41	T0 92	80	80	4.0	100A	300W	135J	125.000G	100NA	30V	195	.005A
MPSA70-BLU	N	S	MOT	41	T0 92	40	40	4.0	100A	300W	135J	125.000G	100NA	50V	150	.005A
MPSA70-GRN	N	S	MOT	41	T0 92	40	40	4.0	100A	300W	135J	125.000G	100NA	50V	150	.005A
MPSA70-REO	N	S	MOT	41	T0 92	40	40	4.0	100A	300W	135J	125.000G	100NA	50V	120	.005A
MPSA70-WHT	N	S	MOT	41	T0 92	40	40	4.0	100A	300W	135J	125.000G	100NA	50V	225	.005A
MPSA70-YEL	N	S	MOT	41	T0 92	20	20	3.0	500W	135J	135J	375.000G	50NA	10V	70	.004A
MPSH02	N	S	MOT	41	T0 92	30	25	3.0	310W	135J	135J	650.000G	100NA	25V	90	.004A
MPSH11	N	S	MOT	41	T0 92	30	25	3.0	310W	135J	135J	400.000G	50NA	15V	38	.004A
MPSH20	N	S	MOT	41	T0 92	40	30	4.0	100A	310W	135J	300.000G	50NA	10V	70	.004A
MPSH30	N	S	MOT	41	T0 92	20	20	3.0	310W	135J	135J	300.000G	50NA	10V	35	.004A
MPSH31	N	S	MOT	41	T0 92	20	20	3.0	310W	135J	135J	300.000G	50NA	10V	35	.004A
MPSH32	N	S	MOT	41	T0 92	40	30	4.0	100A	300W	135J	300.000G	50NA	10V	88	.005A
MPSH37	N	S	MOT	41	T0 92	140	120	5.0	600A	1000W	135J	60.000G	100NA	15V	110	.010A
MPSL01	N	S	MOT	41	T0 92	6	6	4.5	080A	310W	135J	500.000G	10NA	3V	50	.010A
MPSL07	N	S	MOT	41	T0 92	12	12	4.5	080A	310W	135J	700.000G	10NA	6V	50	.010A
MPSL08	N	S	MOT	41	T0 92	100</										

Transistor Type No.	N P S	G S	Manufacturer	Lead Ident	Out- line	Maximum (V)			Maximum		Max. T.(°C)	Frequency Resp.(MHz)	Leakage		Gain
						V _{CE}	V _{BE}	V _{ES}	I _C	Power			I _{ES} @ V _{ES}	I _{ES} @ V _{ES}	
MP5U56	P	S	MOT	49	49A	80	80	4.0	1.000A	5.000W	135J	50.000G	100NA	60V	85 .250A
MP7A40	P	S	M.P. PT40												
MP7501	P	S	M.P. PT501												
MSA7505	P	S	SEE RF POWER SECTION												
MSA8505	P	S	SEE RF POWER SECTION												
MSA8506	P	S	SEE RF POWER SECTION												
MT1060	N	S	FSC	211	TO 46	30	14	4.0	.080A	.300W	175J	1000.000G	500NA	10V	40 .001A
MT1061	N	S	FSC	211	TO 46	30	14	4.0	.080A	.300W	175J	1300.000G	500NA	10V	70 .001A
MT1061A	N	S	FSC	217	TO 72	30	14	4.0	.080A	.250W	175J	1000.000G	500NA	10V	40 .001A
MT1061B	N	S	FSC	217	TO 72	30	14	4.0	.080A	.250W	175J	1300.000G	500NA	10V	70 .001A
N20	N	G	SEM	890	890B	30	14	4.0	.080A	.150W	175J	1300.000G	500NA	10V	70 .001A
NA30	N	G	SEM	210	TO 5	30	20	10.0	.200A	.200W		1.000G			50
NO400	N	S	SEM	605	TO 3	35	25	20.0	.200A	.250W		.500G			100
NKT121	P	G	NKT	210	TO 5	20	20S	6.0	10.000A	100.000W		5.000G			20
NKT122	P	G	NKT	210	TO 5	20	20S	6.0	.500A	.075W	75J	15.000B	5UA	10V	80
NKT123	P	G	NKT	210	TO 5	20	20S	6.0	.500A	.075W	75J	7.000B	5UA	10V	80
NKT124	P	G	NKT	210	TO 5	20	20S	6.0	.500A	.075W	75J	3.000B	5UA	10V	80
NKT125	P	G	NKT	210	TO 5	20	20S	6.0	.500A	.075W	75J	15.000B	5UA	10V	120
NKT126	P	G	NKT	210	TO 5	20	20S	6.0	.500A	.075W	75J	7.000B	5UA	10V	120
NKT127	P	G	NKT	210	TO 5	20	20S	6.0	.500A	.075W	75J	3.000B	5UA	10V	120
NKT128	P	G	NKT	210	TO 5	20	20S	6.0	.500A	.075W	75J	15.000B	5UA	10V	120
NKT129	P	G	NKT	210	TO 5	20	20S	6.0	.500A	.075W	75J	7.000B	5UA	10V	80
NKT211	P	G	NKT	120	TO 1	32	32R	10.0	.125A	.200W	90J	9.000B	10UA	10V	100
NKT213	P	G	NKT	120	TO 1	32	32R	10.0	.125A	.200W	90J	9.000B	10UA	10V	100
NKT214	P	G	NKT	120	TO 1	32	32R	10.0	.125A	.200W	90J	9.000B	10UA	10V	50
NKT215	P	G	NKT	120	TO 1	32	32R	10.0	.125A	.200W	90J	9.000B	10UA	10V	30
NKT217	P	G	NKT	120	TO 1	60	60R	10.0	.125A	.200W	90J	9.000B	10UA	10V	160
NKT218	P	G	NKT	120	TO 1	32	32R	10.0	.500A	.200W	90J	9.000B	10UA	10V	80
NKT221	P	G	NKT	211	TO 39	30	30S	10.0	.500A	.300W	85J	.750B	10UA	5V	100
NKT222	P	G	NKT	211	TO 39	30	30S	10.0	.125A	.180W	75J	.750B	10UA	5V	120
NKT223	P	G	NKT	211	TO 39	30	30S	10.0	.125A	.180W	75J	.750B	10UA	5V	120
NKT224	P	G	NKT	211	TO 39	30	30S	10.0	.125A	.180W	75J	.750B	10UA	5V	120
NKT225	P	G	NKT	211	TO 39	30	30S	10.0	.125A	.180W	75J	.750B	10UA	5V	30
NKT226	P	G	NKT	211	TO 39	30	30S	10.0	.125A	.180W	75J	.750B	10UA	5V	100
NKT227	P	G	NKT	211	TO 39	30	30S	10.0	.125A	.180W	75J	.750B	10UA	5V	60
NKT228	P	G	NKT	211	TO 39	30	30S	10.0	.125A	.180W	75J	.750B	10UA	5V	120
NKT231	P	G	NKT	211	TO 39	60	60S	10.0	.125A	.180W	75J	.750B	10UA	5V	60
NKT232	P	G	NKT	211	TO 39	15	15S	10.0	.500A	.300W	85J	.750B	25UA	15V	150
NKT301	P	G	NKT	211	TO 39	15	15S	10.0	.500A	.300W	85J	.750B	25UA	15V	50
NKT302	P	G	NKT	171	TO 8	60	40	15.0	2.000A	.750W	85C	5.000B	50UA	2V	100
NKT303	P	G	NKT	171	TO 8	30	20	15.0	2.000A	.750W	85C	5.000B	50UA	2V	130
NKT304	P	G	NKT	171	TO 8	30	20	15.0	2.000A	7.000W	85C	5.000B	50UA	2V	100
NKT401	P	G	NKT	605	TO 3	80	30	20.0	8.000A	.750W	85C	.010E	100UA	2V	50
NKT402	P	G	NKT	605	TO 3	80	30	20.0	8.000A	12.000W	85C	.010E	100UA	2V	100
NKT403	P	G	NKT	605	TO 3	80	30	20.0	8.000A	12.000W	85C	.010E	100UA	2V	100
NKT404	P	G	NKT	605	TO 3	80	30	20.0	8.000A	12.000W	85C	.010E	100UA	2V	100
NKT405	P	G	NKT	605	TO 3	60	20	20.0	8.000A	12.000W	85C	.010E	100UA	2V	120
NKT451	P	G	NKT	605	TO 3	60	45R	20.0	6.000A	12.000W	85C	.009E	100UA	2V	120
NKT452	P	G	NKT	605	TO 3	36	36R	10.0	2.000A	13.000W	85C	144.000B	100UA	2V	100
NKT453	P	G	NKT	605	TO 3	36	36R	10.0	2.000A	13.000W	85C	144.000B	100UA	2V	60
NKT713	N	G	SEM	120	TO 1	25	25R	15.0	.200A	.150W	80J	1.000B	100UA	25V	100
NKT773	N	G	SEM	210	TO 5	25	15R	5.0	.300A	.150W	85J	AUD	5UA	10V	50
NR10	N	G	SEM	210	TO 5	20	20	10.0	.100A	.200W		10.000G			70
NR700	N	G	SEM	210	TO 18	15	15	20.0	.100A	.100W		20.000G			150
NS381	-N	S	NSC	210	TO 18	25	20	3.0	.100A	.300W	200J	400.000G			40
NS475	-N	S	NSC	210	TO 46	30	30	6.0	.100A	.400W	200J	80.000B	200NA	30V	36
NS476	-N	S	NSC	210	TO 46	30	30	6.0	.100A	.400W	200J	80.000B	200NA	30V	70
NS477	-N	S	NSC	210	TO 46	30	30	6.0	.100A	.400W	200J	80.000B	200NA	30V	180
NS478	-N	S	NSC	210	TO 46	60	60	8.0	.100A	.400W	200J	8.000B	200NA	60V	36
NS479	-N	S	NSC	210	TO 46	60	60	8.0	.100A	.400W	200J	8.000B	200NA	60V	7
NS480	-N	S	NSC	210	TO 18	15	15	4.0	.400W	.400W	175J	80.000B	200NA	60V	180
NS731	-N	S	NSC	210	TO 18	15	15	4.0	.400W	.400W	175J	80.000B	200NA	60V	36
NS732	-N	S	NSC	210	TO 18	30	30	4.0	.400W	.400W	175J	80.000B	200NA	60V	36
NS733	-N	S	NSC	210	TO 18	30	30	4.0	.400W	.400W	175J	80.000B	200NA	60V	36
NS734	-N	S	NSC	210	TO 18	30	30	4.0	.400W	.400W	175J	80.000B	200NA	60V	36
NS792	-N	S	NSC	210	TO 5	60	60	5.0	1.000A	8.000W	200J	150.000G			80
NS793	-N	S	NSC	210	TO 5	60	60	5.0	1.000A	8.000W	200J	150.000G			80
OC16	-P	G	MUL, PHN	498	498A	32	16	10.0	3.000A	50.000W	75J	2.00B	1MA	14V	36
OC22	P	G	MUL, PHN, RAD	605	TO 3	47	32	15.0	1.000A	16.000W	75J	2.500B			100
OC23	P	G	MUL, PHN, RAD	605	TO 3	55	40	15.0	1.000A	16.000W	75J	2.500B			100
OC24	P	G	MUL, PHN, RAD	605	TO 3	47	40	15.0	1.000A	16.000W	75J	2.500B			100
OC26	P	G	SEE 2N1314												
OC27	P	G	PHN	605	TO 3	32	16	10.0	3.500A	54.000W	90J	.004E	20MA	14V	70
OC28	P	G	SEE 2N1666												
OC29	P	G	SEE 2N1667												
OC30	P	G	RAO	605	605A	32	32	10.0	1.400A	6.500W	75J	.150B			33
OC35	P	G	SEE 2N1668												
OC36	P	G	SEE 2N1669												
OC44	P	G	AMP, MUL, PHN	55	55A	15	5	12.0	.005A	.080W	75J	7.500B	10UA	15V	100
OC45	P	G	AMP, MUL, PHN	55	55A	15	5	12.0	.005A	.080W	75J	3.000B	10UA	15V	40
OC46	P	G	PHN, RAD	55	55A	20	15	15.0	.125A	.083W	75J	3.000B			100
OC47	P	G	RAO	105	105B	20	20	15.0	.125A	.083W	75J	4.500B			100
OC57	P	G	RAO	105	105B	7	7	7.0	.010A	.020W	55J	2.000B			35
OC58	P	G	RAO, AMP	105	105B	7	7	7.0	.010A	.020W	55J	2.000B			55
OC59	P	G	AMP, PHN, RAO	105	105B	7	7	7.0							

Transistor Type No.	K P	G S	Manufacturer	Lead Ident	Out- line	Maximum (V)			Maximum Power		T.(°C)	Frequency Resp.(MHz)	Leakage I _{sat} @ V _{CE}	Gain h _{FE} @ I _C	
						V _{CE}	V _{CE}	V _{CE}	I _C	Power					
OC603	P	G	TFK SEE AC122	55	55F	20	12	10.0		.125W	75J	1.000G	10UA	6V	50
OC604	-P	G	TFEE	55	55F	40	15	10.0	.500A	.175W	75J		6UA	6V	50
OC613	P	G	TFK SEE AF101	55	550	25	12	8		.030W	75J	28.000G	2UA	6V	120
OC614	P	G	TFK	55	550	12	8			.030W	75J	50.000G	3UA	6V	160
OC615	P	G	TFK	698	698A	40	30	10.0	3.000A	4.000W	75J	.009E	10UA	6V	34
OC603/50	P	G	TFK	698	698A	60	50	30.0	1.000A	4.000W	75J	.009E	10UA	6V	30
PA0750	P	G	AMP	605	605 T	70	25	15.0	3.000A	12.500W	75J	60.000G	600UA	6V	80
PAR12	P	G	SEM	621	TO 27	50	25	10.0	3.000A	50.000W	100J	2.00G	100NA	45V	180
PBC107A	N	S	SES	45	TO 98	45	45	5.0	1.00A	2.00W	100J	150.000G	100NA	45V	290
PBC107B	N	S	SES	45	TO 98	45	45	5.0	1.00A	2.00W	100J	150.000G	100NA	45V	290
PBC108A	N	S	SES	45	TO 98	20	20	5.0	1.00A	2.00W	100J	150.000G	100NA	20V	280
PBC108B	N	S	SES	45	TO 98	20	20	5.0	1.00A	2.00W	100J	150.000G	100NA	20V	520
PBC108C	N	S	SES	45	TO 98	20	20	5.0	1.00A	2.00W	100J	150.000G	100NA	20V	290
PBC109B	N	S	SES	45	TO 98	20	20	5.0	1.00A	2.00W	100J	150.000G	100NA	20V	520
PBC109C	N	S	SES	45	TO 98	20	20	5.0	1.00A	2.00W	100J	150.000G	100NA	20V	520
PEP9	N	S	AEI	211	TO 18	40	20	5.0	1.00A	3.00W	175J	200.000G	50NA	20V	70
PEP95	N	S	AEI	170	TO 106	45	45	4.0	1.50A	.360W	125J	200.000G	500NA	30V	80
PET1001	N	S	PHF	170	TO 106	45	45	4.0	1.50A	.360W	125J	200.000G	500NA	30V	200
PET1002	N	S	PHF	170	TO 106	90	60	7.0	1.50A	.360W	125J	60.000G	1UA	70V	160
PET1075	N	S	PHF	170	TO 106	35	20	4.0	1.50A	.360W	125J	200.000G	50NA	30V	160
PET1075A	N	S	PHF	170	TO 106	35	20	4.0	1.50A	.360W	125J	200.000G	50NA	30V	160
PET2001	N	S	PHF	170	TO 106	35	20	4.0	1.50A	.360W	125J	200.000G	50NA	30V	200
PET2002	N	S	PHF	170	TO 106	35	20	4.0	1.50A	.360W	125J	200.000G	50NA	30V	200
PET3001	N	S	PHF	170	TO 106	30	12	4.0	1.00A	.250W	125J	600.000G	1UA	20V	45
PET3002	N	S	PHF	170	TO 106	30	12	4.0	1.00A	.250W	125J	600.000G	1UA	20V	45
PET3704	N	S	PHF	170	TO 106	50	30	5.0	800A	.360W	125J	100.000G	100NA	20V	175
PET3705	N	S	PHF	170	TO 106	50	30	5.0	800A	.360W	125J	100.000G	100NA	20V	88
PET3706	N	S	PHF	170	TO 106	40	20	5.0	800A	.360W	125J	100.000G	100NA	20V	180
PET4001	N	S	PHF	170	TO 106	30	25	8.0	1.00A	.360W	125J	60.000G	10NA	25V	350
PET4002	N	S	PHF	170	TO 106	30	25	8.0	1.00A	.360W	125J	60.000G	10NA	25V	525
PF4003	N	S	PHF	170	TO 106	40	30	5.0	750A	.360W	125J	45.000G	50NA	15V	75
PET6002	N	S	PHF	170	TO 106	40	30	5.0	750A	.360W	125J	45.000G	50NA	15V	150A
PET8000	N	S	PHF	170	TO 106	50	35	8.0	800A	.360W	125J	40.000G	10NA	25V	262
PET8001	N	S	PHF	170	TO 106	50	35	8.0	800A	.360W	125J	40.000G	10NA	25V	375
PET8002	N	S	PHF	170	TO 106	50	35	8.0	800A	.360W	125J	40.000G	10NA	25V	262
PET8003	N	S	PHF	170	TO 106	50	35	8.0	800A	.360W	125J	40.000G	10NA	25V	375
PET8004	N	S	PHF	170	TO 106	50	35	8.0	800A	.360W	125J	40.000G	10NA	25V	262
PET8101	N	S	PHF	170	TO 106	18	12	4.0	1.00A	.250W	125J	800.000G	50NA	12V	37
PN66	N	S	SEM	605	TO 66	300	200	5.0	3.000A	90.000W		1.000G			30
PN350	N	S	SEM	605	TO 66	100	80	7.0	10.000A	150.000W		1.000G			3
PT2A	-P	G	CBS	146	146C	40	40	0.0	0.10A	.100W	55A	2.00B			4
PT2S	-P	G	CBS	146	146C	40	40	0.0	0.10A	.100W	55A	2.00B			4
PT6	P	G	SEM	605	TO 3	30	12	10.0	3.000A	90.000W		.200G			40
PT12	P	G	SEM	605	TO 3	30	12	12.0	3.000A	90.000W		.200G			60
PT25	P	G	SEM	605	TO 3	40	25	20.0	5.000A	90.000W		.200G			40
PT32	P	G	SEM	605	TO 66	45	25	12.0	2.000A	6.000W		.200G			60
PT40	P	G	SEM	605	TO 3	80	40	20.0	8.000A	90.000W		.200G			90
PT150	P	G	SEM	605	TO 3	100	60	20.0	7.000A	90.000W		.200G			50
PT201	P	G	SEM	605	TO 36	40	25	12.0	15.000A	150.000W		.200G			40
PT250	P	G	SEM	607	TO 41	100	50	20.0	25.000A	150.000W		.200G			40
PT501	P	G	SEM	405	TO 36	60	30	20.0	15.000A	150.000W		.200G			40
PT15	P	G	SEM	405	TO 36	100	60	40.0	30.000A	170.000W		.200G			50
PT530A			SEE 2N1709												
PT531			SEE 2N2783												
PT600	N	S	TRW	171	TO 8	60	45R	4.0		13.000W		150.000G	1MA	12V	26
PT612	N	S	TRW	170	TO 8	60	45R	4.0	.350A	13.000W	175J	180.000G	1MA	12V	52
PT613	N	S	TRW	170	TO 8	75	60R	5.0		2.000W		60.000G	500UA	28V	26
PT655	N	S	SEE 2N2782												
PT665A	N	S	TRW	561	TO 61	75	60R	4.0	.350A	20.000W		15.000G	10UA	28V	26
PT692	N	S	TRW	561	TO 61	100	90R	5.0	.350A	20.000W		15.000G	10UA	28V	26
PT703	N	S	TRW	211	TO 18	25	25R	5.0	.020A	.360W	175J	50.000G	5UA	15V	
PT720	N	S	TRW	211	TO 18	25	15	5.0	.200A	.360W	200J	250.000G	500NA	15V	80
PT886	N	S	TRW	211	TO 5	22	25R	5.0	.600W	.175J		300UA	10V		
PT887	N	S	TRW	211	TO 5	45	50R	5.0	.600W	.175J		300UA	10V		
PT888	N	S	TRW	211	TO 5	45	50R	5.0	.600W	.175J		300UA	10V		
PT896	N	S	TRW	211	TO 5	45	50R	5.0	1.600W			300UA	10V		
PT897	N	S	TRW	211	TO 5	45	50R	5.0	.600W	.175J		300UA	10V		
PT898	N	S	TRW	211	TO 5	45	50R	5.0	1.600W			300UA	10V		
PT1515	N	S	TRW	211	TO 5	80	80R	4.0	.110A	3.000W		500.000G	10UA	28V	40
PT1544	N	S	TRW	211	TO 5	50	50R	4.0	.800W		175J	100UA	15V		
PT1545	N	S	TRW	211	TO 5	50	50R	4.0	.800W		175J	100UA	15V		
PT1558	N	S	TRW	211	TO 5	80	45	5.0	.110A	.800W	200J	140.000G	50NA	28V	36
PT1937	N	S	TRW	414	TO 81	140	50	4.0	7.000A	100.000W	150J	40.000G	50MA	140V	30
PT1941	N	S	TRW	560	TO 61	140	130R	4.0	7.000A	90.000W	150J	40.000G	50MA	140V	30
PT1949	N	S	TRW	911	TO 11A	140	100R	5.0		50.000W			10MA	60V	18
PT1963	N	S	TRW	560	TO 61	140	100R	5.0		50.000W			10MA	60V	18
PT2523	N	S	TRW	211	TO 5	180	130	5.0		5.000W		50.000G	10NA	120V	40
PT2524	N	S	TRW	211	TO 5	200	160	5.0		5.000W		50.000G	10NA	120V	40
PT2525	N	S	TRW	211	TO 5	220	170	5.0		5.000W		50.000G	10NA	120V	40
PT2540	N	S	TRW	211	TO 5	60	32	4.0	.200A	13.000W	200J	200.000G	10UA	20V	30
PT2620	N	S	TRW	211	TO 5	100	60	4.0	.200A	13.000W		125.000G	100UA	28V	46
PT2620A	N	S	TRW	211	TO 5	85	45	4.0	.170A	10.000W		125.000G	100UA	28V	56
PT2630	N	S	TRW	211	TO 5	85	45	4.0	.170A	10.000W		125.000G	100UA	28V	56
PT2635	N														

Transistor Type No.	N P	G S	Manufacturer	Lead Ident	Out- line	Maximum (V)			Maximum		Max. T.(°C)	Frequency Resp.(MHz)	Leakage		Gain	
						V _{CE}	V _{ES}	V _{ES}	I _C	Power			I _{ES} @ V _{ES}	I _{ES} @ V _{ES}		
RT5204	-N	S	RAY	210	To 5	30	30S	5.0	.600W	150A	40.000G	1UA	15V	70		
RT5212	-N	S	RAY	210	To 5	30	60S	5.0	.600W	150A	40.000G	1UA	30V	70		
RT5230	-N	S	SEE 2N2309													
RT5401	-N	S	RAY	211	To 5	30	20	7.0	.750A	.700W	200J	100.000G	1UA	30V	100	
RT5403	-N	S	RAY	211	To 5	30	18	7.0	.750A	.700W	200J	100.000G	1UA	30V	100	
RT5407	-N	S	RAY	211	To 5	60	24	7.0	.750A	.700W	200J	90.000G	1UA	30V	100	
RT5404	-N	S	RAY	211	To 5	30	25	6.0	.750A	.700W	200J	90.000G	1UA	30V	100	
S15649	-N	S	FSC	170	170F	30	25	6.0	.200W	125J	20.000G	50NA	25V	350	.001A	
S15650	-N	S	FSC	170	170F	30	25	6.0	.200W	125J	20.000G	50NA	25V	350	.001A	
S15657	-N	S	FSC	170	170F	40	15	4.0	.200W	125J	400.000G	50NA	15V	70	.002A	
S15658	-N	S	FSC	170	170F	40	15	4.0	.200W	125J	400.000G	50NA	15V	70	.015A	
S15659	-N	S	FSC	211	To 5	40	20	4.0	.600W	200J	500.000G	50NA	20V	70	.050A	
S15660	-N	S	FSC	211	To 5	40	15	4.0	.600W	200J	400.000G	500UA	40V	60	.300A	
S18100	-P	S	FSC	909	To 50	60	60	4.0	1.000A	.600W	200J	130.000G	10NA	25V	70	.050A
S18200	-N	S	FSC	909	To 50	100	60	7.0	.400W	200J	60.000G	10NA	60V	100	.150A	
SA310	P	S	SPR	229	To 5	30	10		.050A	.150W	140J	10.000G	10NA	15V	30	
SA311	P	S	SPR	229	To 5	30	16		.050A	.150W	140J	10.000G	10NA	15V	30	
SA312	P	S	SPR	229	To 5	30	20		.050A	.150W	140J	18.000G	10NA	15V	30	
SA313	P	S	SPR	229	To 5	30	15		.050A	.150W	140J	17.000G	10NA	15V	30	
SA314	P	S	SPR	229	To 5	30	12		.050A	.150W	140J	18.000G	20NA	15V	30	
SA315	P	S	SPR	229	To 5	30	10		.050A	.150W	140J	10.000G	10NA	15V	30	
SA316	P	S	SPR	229	To 18	30	6		.050A	.150W	140J	8.000G	10NA	15V	30	
SA410	P	S	SPR	229	To 18	30	10		.050A	.150W	140J	7.000G	10NA	15V	30	
SA411	P	S	SPR	229	To 18	30	10		.050A	.150W	140J	8.000G	20NA	15V	30	
SA412	P	S	SPR	120	To 1	25	20		.050A	.150W	140J	7.000G	3NA	10V	20	
SA413	P	S	SPR	120	To 1	10	6		.050A	.150W	140J	8.000G	20NA	15V	30	
SA414	P	S	SPR	229	To 18	30	10		.050A	.150W	140J	7.000G	10NA	15V	30	
SA415	P	S	SPR	229	To 18	30	10		.050A	.150W	140J	7.000G	10NA	15V	30	
SA416	P	S	SPR	229	To 18	30	12		.050A	.150W	140J	8.000G	20NA	15V	30	
SA537	P	S	SPR	120	To 1	25	20		.050A	.150W	140J	7.000G	3NA	10V	20	
SA538	P	S	SPR	120	To 1	10	6		.050A	.150W	140J	8.000G	20NA	15V	30	
SA539	P	S	SPR	210	To 18	25	20		.050A	.150W	140J	100NA	5V	15	.005A	
SA540	P	S	SPR	210	To 18	10	6		.050A	.150W	140J	100NA	5V	15	.005A	
SB100	-P	G	PHL	105	To 24	5			.050A	.150W	140J	100NA	5V	15	.005A	
SB101			SEE 2N344						.005A	.020W	55J	60.000F	3UA	5V	20	
SB102			SEE 2N345													
SB103			SEE 2N346													
SB200	-P	G	PHL	105	To 24	5			.005A	.020W	55J	30.000F	3UA	5V	14	
SDT1001	-N	S	SOL	605	To 3	200	5.0		3.500A	100.000W	200J	5.000G	5MA	250V	20	1.000A
SDT1002	-N	S	SOL	605	To 3	250	5.0		3.500A	100.000W	200J	5.000G	5MA	250V	20	1.000A
SDT1003	-N	S	SOL	605	To 3	300	5.0		3.500A	100.000W	200J	5.000G	500UA	300V	40	1.000A
SDT1004	-N	S	SOL	605	To 3	350	5.0		3.500A	100.000W	200J	5.000G	500UA	300V	40	1.000A
SDT1005	-N	S	SOL	605	To 3	450	5.0		3.500A	100.000W	200J	5.000G	500UA	400V	40	1.000A
SDT1006	-N	S	SOL	605	To 3	500	5.0		3.500A	100.000W	200J	5.000G	500UA	400V	40	1.000A
SDT1011	-N	S	SOL	605	To 3	200	5.0		5.000A	100.000W	200J	5.000G	10MA	200V	20	3.000A
SDT1012	-N	S	SOL	605	To 3	250	5.0		5.000A	100.000W	200J	5.000G	10MA	250V	20	3.000A
SDT1013	-N	S	SOL	605	To 3	300	5.0		5.000A	100.000W	200J	5.000G	5MA	300V	38	3.000A
SDT1014	-N	S	SOL	605	To 3	350	5.0		5.000A	100.000W	200J	5.000G	5MA	300V	38	3.000A
SDT1015	-N	S	SOL	605	To 3	400	5.0		5.000A	100.000W	200J	5.000G	5MA	350V	38	3.000A
SDT1016	-N	S	SOL	605	To 3	450	5.0		5.000A	100.000W	200J	5.000G	5MA	400V	38	3.000A
SDT1017	-N	S	SOL	605	To 3	450	5.0		5.000A	100.000W	200J	5.000G	5MA	450V	38	3.000A
SDT1050	N	S	SOL	605	To 3	250	5.0		5.000A	100.000W	200J	5.000G	5MA	500V	38	3.000A
SDT1051	N	S	SOL	605	To 3	400	8.0		5.000A	80.000W	200J	50.000G	5MA	100V	23	1.000A
SDT1052	N	S	SOL	605	To 3	500	8.0		5.000A	80.000W	200J	50.000G	5MA	100V	23	1.000A
SDT1053	N	S	SOL	605	To 3	600	8.0		5.000A	80.000W	200J	50.000G	5MA	100V	23	1.000A
SDT1054	N	S	SOL	605	To 3	700	8.0		5.000A	80.000W	200J	50.000G	5MA	100V	23	1.000A
SDT1055	N	S	SOL	605	To 3	800	8.0		5.000A	80.000W	200J	50.000G	5MA	100V	23	1.000A
SDT1056	N	S	SOL	605	To 3	250	200	8.0	5.000A	80.000W	200J	50.000G	5MA	100V	23	1.000A
SDT1057	N	S	SOL	605	To 3	300	400	8.0	5.000A	80.000W	200J	50.000G	5MA	100V	23	1.000A
SDT1058	N	S	SOL	605	To 3	400	400	8.0	5.000A	80.000W	200J	50.000G	5MA	100V	23	1.000A
SDT1059	N	S	SOL	605	To 3	500	400	8.0	5.000A	80.000W	200J	50.000G	5MA	100V	23	1.000A
SDT1060	N	S	SOL	605	To 3	600	400	8.0	5.000A	80.000W	200J	50.000G	5MA	100V	23	1.000A
SDT1061	N	S	SOL	605	To 3	700	400	8.0	5.000A	80.000W	200J	50.000G	5MA	100V	23	1.000A
SDT1062	N	S	SOL	605	To 3	800	400	8.0	5.000A	80.000W	200J	50.000G	5MA	100V	23	1.000A
SDT1063	N	S	SOL	605	To 3	250	200	8.0	5.000A	80.000W	200J	50.000G	5MA	100V	23	1.000A
SDT1064	N	S	SOL	605	To 3	300	400	8.0	5.000A	80.000W	200J	50.000G	5MA	100V	23	1.000A
SDT1065	N	S	SOL	605	To 3	400	400	8.0	5.000A	80.000W	200J	50.000G	5MA	100V	23	1.000A
SDT1150	N	S	SOL	605	To 66	250	200	8.0	5.000A	40.000W	200J	50.000G	5MA	100V	23	1.000A
SDT1151	N	S	SOL	605	To 66	400	325	8.0	5.000A	40.000W	200J	50.000G	5MA	100V	23	1.000A
SDT1152	N	S	SOL	605	To 66	500	400	8.0	5.000A	40.000W	200J	50.000G	5MA	100V	23	1.000A
SDT1153	N	S	SOL	605	To 66	700	400	8.0	5.000A	40.000W	200J	50.000G	5MA	100V	23	1.000A
SDT1154	N	S	SOL	605	To 66	250	200	8.0	5.000A	40.000W	200J	50.000G	5MA	100V	23	1.000A
SDT1155	N	S	SOL	605	To 66	400	325	8.0	5.000A	40.000W	200J	50.000G	5MA	100V	23	1.000A
SDT1156	N	S	SOL	605	To 66	500	400	8.0	5.000A	40.000W	200J	50.000G	5MA	100V	23	1.000A
SDT1157	N	S	SOL	605	To 66	600	400	8.0	5.000A	40.000W	200J	50.000G	5MA	100V	23	1.000A
SDT1158	N	S	SOL	605	To 66	700	400	8.0	5.000A	40.000W	200J	50.000G	5MA	100V	23	1.000A
SDT1159	N	S	SOL	605	To 66	250	200	8.0	5.000A	40.000W	200J	50.000G	5MA	100V	23	1.000A
SDT1160	N	S	SOL	605	To 66	400	325	8.0	5.000A	40.000W	200J	50.000G	5MA	100V	23	1.000A
SDT11																

Transistor Type No.	N P S	C P S	Manufacturer	Lead Ident	Out. Pin	Maximum (V)			Maximum Power		Max. T.(°C)	Frequency Resp.(MHz)	Leakage		Gain h _{FE} @ I _C
						V _{CE}	V _{BE}	V _{ES}	I _C	P			I _{ES} @ V _{CE}	I _{CS} @ I _C	
SDT2008	P	P	G	SOL	571	571A	80	60	60.00A	140.00W	110J			22	50.00A
SDT2009	P	P	G	SOL	571	571A	60	45	60.00A	140.00W	110J			22	50.00A
SDT2010	P	P	G	SOL	571	571A	40	30	60.00A	140.00W	110J			22	50.00A
SDT2101	P	P	G	SOL	390	390A	10	5	200.00A	100.00W	100J			60	99.00A
SDT2110	P	P	G	SOL	390	390A	10	5	200.00A	100.00W	100J			60	99.00A
SDT2111	P	P	G	SOL	390	390A	10	5	200.00A	100.00W	100J			60	99.00A
SDT2112	P	P	G	SOL	390	390A	10	5	200.00A	100.00W	100J			60	99.00A
SDT2150	P	P	G	SOL	390	390B	10	5	200.00A	100.00W	100J			60	99.00A
SDT2151	P	P	G	SOL	390	390B	10	5	200.00A	100.00W	100J			60	99.00A
SDT2152	P	P	G	SOL	390	390B	10	5	200.00A	100.00W	100J			60	99.00A
SDT2205	P	P	G	SOL	176	176E	10	5	50.00A	120.00W	110J			60	50.00A
SDT2305	P	P	G	SOL	403	TO 68	10	5	50.00A	120.00W	110J			60	50.00A
SDT3101	P	P	S	SOL	560	TO 61	40	6.0	10.00A	50.00W	200J	40.00GG	10UA 40V	52	10.00A
SDT3102	P	P	S	SOL	560	TO 61	40	6.0	10.00A	50.00W	200J	40.00GG	10UA 60V	52	10.00A
SDT3103	P	P	S	SOL	560	TO 61	80X	6.0	10.00A	50.00W	200J	30.00GG	10UA 80V	52	10.00A
SDT3104	P	P	S	SOL	560	TO 61	100X	6.0	10.00A	50.00W	200J	30.00GG	10UA 100V	52	10.00A
SDT3105	P	P	S	SOL	560	TO 61	40	6.0	10.00A	50.00W	200J	40.00GG	10UA 40V	52	5.00A
SDT3106	P	P	S	SOL	560	TO 61	60	6.0	10.00A	50.00W	200J	40.00GG	10UA 60V	52	5.00A
SDT3107	P	P	S	SOL	560	TO 61	80X	6.0	10.00A	50.00W	200J	30.00GG	10UA 80V	52	5.00A
SDT3108	P	P	S	SOL	560	TO 61	100X	6.0	10.00A	50.00W	200J	30.00GG	10UA 100V	52	5.00A
SDT3109	P	P	S	SOL	560	TO 61	120	6.0	10.00A	50.00W	200J	40.00GG	10UA 120V	52	5.00A
SDT3125	P	P	S	SOL	568	TO111	40X	6.0	10.00A	30.00W	200J	30.00GG	10UA 40V	40	5.00A
SDT3126	P	P	S	SOL	568	TO111	60X	6.0	10.00A	30.00W	200J	30.00GG	10UA 60V	40	5.00A
SDT3127	P	P	S	SOL	568	TO111	80X	6.0	10.00A	30.00W	200J	30.00GG	10UA 80V	40	5.00A
SDT3128	P	P	S	SOL	568	TO111	100X	6.0	10.00A	30.00W	200J	30.00GG	10UA 100V	40	5.00A
SDT3129	P	P	S	SOL	568	TO111	120X	6.0	10.00A	30.00W	200J	30.00GG	10UA 120V	40	5.00A
SDT3201	N	N	N	SOL	560	TO 61	120X	6.0	10.00A	50.00W	200J	30.00GG	10UA 60V	52	10.00A
SDT3202	N	N	N	SOL	560	TO 61	60X	6.0	10.00A	50.00W	200J	30.00GG	10UA 40V	52	10.00A
SDT3203	N	N	N	SOL	560	TO 61	80X	6.0	10.00A	50.00W	200J	30.00GG	10UA 80V	52	10.00A
SDT3204	N	N	N	SOL	560	TO 61	100X	6.0	10.00A	50.00W	200J	30.00GG	10UA 100V	52	10.00A
SDT3205	N	N	N	SOL	560	TO 61	40X	6.0	10.00A	50.00W	200J	30.00GG	10UA 40V	52	5.00A
SDT3206	N	N	N	SOL	560	TO 61	60X	6.0	10.00A	50.00W	200J	30.00GG	10UA 60V	52	5.00A
SDT3207	N	N	N	SOL	560	TO 61	80X	6.0	10.00A	50.00W	200J	30.00GG	10UA 80V	52	5.00A
SDT3208	N	N	N	SOL	560	TO 61	100X	6.0	10.00A	50.00W	200J	30.00GG	10UA 100V	52	5.00A
SDT3209	N	N	N	SOL	560	TO 61	120X	6.0	10.00A	50.00W	200J	30.00GG	10UA 120V	52	5.00A
SDT3225	N	N	N	SOL	568	TO111	40X	6.0	10.00A	30.00W	200J	30.00GG	10UA 40V	40	5.00A
SDT3226	N	N	N	SOL	568	TO111	60X	6.0	10.00A	30.00W	200J	30.00GG	10UA 60V	40	5.00A
SDT3227	N	N	N	SOL	568	TO111	80X	6.0	10.00A	30.00W	200J	30.00GG	10UA 80V	40	5.00A
SDT3228	N	N	N	SOL	568	TO111	100X	6.0	10.00A	30.00W	200J	30.00GG	10UA 100V	40	5.00A
SDT3229	N	N	N	SOL	568	TO111	120X	6.0	10.00A	30.00W	200J	30.00GG	10UA 120V	40	5.00A
SDT3301	P	P	S	SOL	568	TO111	40X	6.0	5.00A	30.00W	200J	40.00GG	10UA 40V	70	2.00A
SDT3302	P	P	S	SOL	568	TO111	60X	6.0	5.00A	30.00W	200J	40.00GG	10UA 60V	70	2.00A
SDT3303	P	P	S	SOL	568	TO111	80X	6.0	5.00A	30.00W	200J	40.00GG	10UA 80V	70	2.00A
SDT3304	P	P	S	SOL	568	TO111	100X	6.0	5.00A	30.00W	200J	40.00GG	10UA 100V	70	2.00A
SDT3305	P	P	S	SOL	568	TO111	40X	6.0	5.00A	30.00W	200J	40.00GG	10UA 40V	35	2.00A
SDT3306	P	P	S	SOL	568	TO111	60X	6.0	5.00A	30.00W	200J	40.00GG	10UA 60V	35	2.00A
SDT3307	P	P	S	SOL	568	TO111	80X	6.0	5.00A	30.00W	200J	40.00GG	10UA 80V	35	2.00A
SDT3308	P	P	S	SOL	568	TO111	100X	6.0	5.00A	30.00W	200J	40.00GG	10UA 100V	35	2.00A
SDT3309	P	P	S	SOL	568	TO111	120X	6.0	5.00A	30.00W	200J	40.00GG	10UA 120V	35	2.00A
SDT3321	P	P	S	SOL	211	TO 5	40X	6.0	5.00A	4.00W	200J	40.00GG	10UA 40V	70	2.00A
SDT3322	P	P	S	SOL	211	TO 5	60X	6.0	5.00A	4.00W	200J	40.00GG	10UA 60V	70	2.00A
SDT3323	P	P	S	SOL	211	TO 5	80X	6.0	5.00A	4.00W	200J	40.00GG	10UA 80V	70	2.00A
SDT3324	P	P	S	SOL	211	TO 5	100X	6.0	5.00A	4.00W	200J	40.00GG	10UA 100V	70	2.00A
SDT3325	P	P	S	SOL	211	TO 5	40X	6.0	5.00A	4.00W	200J	40.00GG	10UA 40V	35	2.00A
SDT3326	P	P	S	SOL	211	TO 5	60X	6.0	5.00A	4.00W	200J	40.00GG	10UA 60V	35	2.00A
SDT3327	P	P	S	SOL	211	TO 5	80X	6.0	5.00A	4.00W	200J	40.00GG	10UA 80V	35	2.00A
SDT3328	P	P	S	SOL	211	TO 5	100X	6.0	5.00A	4.00W	200J	40.00GG	10UA 100V	35	2.00A
SDT3329	P	P	S	SOL	211	TO 5	120X	6.0	5.00A	4.00W	200J	40.00GG	10UA 120V	35	2.00A
SDT3401	N	N	N	SOL	568	TO111	40X	6.0	5.00A	30.00W	200J	40.00GG	10UA 40V	70	2.00A
SDT3402	N	N	N	SOL	568	TO111	60X	6.0	5.00A	30.00W	200J	40.00GG	10UA 60V	70	2.00A
SDT3403	N	N	N	SOL	568	TO111	80X	6.0	5.00A	30.00W	200J	40.00GG	10UA 80V	70	2.00A
SDT3404	N	N	N	SOL	568	TO111	100X	6.0	5.00A	30.00W	200J	40.00GG	10UA 100V	70	2.00A
SDT3405	N	N	N	SOL	568	TO111	40X	6.0	5.00A	30.00W	200J	40.00GG	10UA 40V	35	2.00A
SDT3406	N	N	N	SOL	568	TO111	60X	6.0	5.00A	30.00W	200J	40.00GG	10UA 60V	35	2.00A
SDT3407	N	N	N	SOL	568	TO111	80X	6.0	5.00A	30.00W	200J	40.00GG	10UA 80V	35	2.00A
SDT3408	N	N	N	SOL	568	TO111	100X	6.0	5.00A	30.00W	200J	40.00GG	10UA 100V	35	2.00A
SDT3409	N	N	N	SOL	568	TO111	120X	6.0	5.00A	30.00W	200J	40.00GG	10UA 120V	35	2.00A
SDT3421	N	N	N	SOL	211	TO 5	40X	6.0	5.00A	4.00W	200J	40.00GG	10UA 40V	70	2.00A
SDT3422	N	N	N	SOL	211	TO 5	60X	6.0	5.00A	4.00W	200J	40.00GG	10UA 60V	70	2.00A
SDT3423	N	N	N	SOL	211	TO 5	80X	6.0	5.00A	4.00W	200J	40.00GG	10UA 80V	70	2.00A
SDT3424	N	N	N	SOL	211	TO 5	100X	6.0	5.00A	4.00W	200J	40.00GG	10UA 100V	70	2.00A
SDT3425	N	N	N	SOL	211	TO 5	40X	6.0	5.00A	4.00W	200J	40.00GG	10UA 40V	35	2.00A
SDT3426	N	N	N	SOL	211	TO 5	60X	6.0	5.00A	4.00W	200J	40.00GG	10UA 60V	35	2.00A
SDT3427	N	N	N	SOL	211	TO 5	80X	6.0	5.00A	4.00W	200J	40.00GG	10UA 80V	35	2.00A
SDT3428	N	N	N	SOL	211	TO 5	100X	6.0	5.00A	4.00W	200J	40.00GG	10UA 100V	35	2.00A
SDT3429	N	N	N	SOL	211	TO 5	120X	6.0	5.00A	4.00W	200J	40.00GG	10UA 120V	35	2.00A
SDT3501	P	P	S	SOL	211	TO 5	40	40	2.00A	4.00W	200J	50.00GG	100NA 30V	45	5.00A
SDT3502	P	P	S	SOL	211	TO 5	60	60	2.00A	4.00W	200J	50.00GG	100NA 40V	45	5.00A
SDT3503	P	P	S	SOL	211	TO 5	80	80	2.00A	4.00W	200J	50.00GG	100NA 60V	45	5.00A
SDT3504	P	P	S	SOL	211	TO 5	100	100	2.00A	4.00W	200J	50.00GG	100NA 80V	45	5.00A
SDT3505	P	P	S	SOL	211	TO 5	40	40	2.00A	4.00W	200J	50.00GG	100NA 30V	88	5.00A
SDT3506	P	P	S	SOL	211	TO 5	60	60	2.00A	4.00W	200J	50.00GG	100NA 40V	88	5.00A
SDT3507	P	P	S	SOL	211	TO 5	80	80	2.00A	4.00W	200J	50.00GG	100NA 60V	88	5.00A
SDT3508	P	P	S	SOL	211	TO 5	100	100	2.00A	4.00W	200J	50.00GG	100NA 80V	88	5.00A
SDT3509	P	P	S	SOL	605	TO 66	40	40	2.00A	16.800W	200J	50.00GG	100NA 30V	45	5.00A
SDT3510	P	P	S	SOL	605	TO 66	60	60	2.00A	16.800W	200J	50.00GG	100NA 40V	45	5.00A
SDT3511	P	P	S	SOL	605	TO 66	80	80	2.00A	16.800W	200J	50.00GG	100NA 60V	45	5.00A
SDT3512	P	P													

Transistor Type No.	N P S	G S	Manufacturer	Lead idnt	Out- line	Maximum (V)			Maximum		Max. T _j (°C)	Frequency Resp.(MHz)	Leakage I _{sat} @ V _{ce}	Gain h _{FE} @ I _c		
						V _{ce}	V _{cs}	V _{es}	I _c	Power						
SDT4310	N	S	SOL	211	To 5	40	40	10.0	2.000A	5.000W	200J	4.000G	150UA	30V	70	1.000A
SDT4311	N	S	SOL	211	To 5	60	60	10.0	2.000A	5.000W	200J	4.000G	150UA	40V	70	1.000A
SDT4312	N	S	SOL	211	To 5	80	80	10.0	2.000A	5.000W	200J	4.000G	150UA	60V	70	1.000A
SDT4451	N	S	SOL	211	To 5	80	40	8.0	5.000A	1.250W	200J	70.000G	1UA	60V	35	1.000A
SDT4452	N	S	SOL	211	To 5	100	80	8.0	5.000A	1.250W	200J	70.000G	1UA	60V	35	1.000A
SDT4453	N	S	SOL	211	To 5	80	80	8.0	5.000A	1.250W	200J	70.000G	1UA	60V	70	1.000A
SDT4454	N	S	SOL	211	To 5	100	80	8.0	5.000A	1.250W	200J	70.000G	1UA	60V	70	1.000A
SDT4455	N	S	SOL	211	To 5	80	40	8.0	5.000A	1.250W	200J	70.000G	1UA	60V	150	1.000A
SDT4456	N	S	SOL	211	To 5	100	80	8.0	5.000A	1.250W	200J	70.000G	1UA	60V	150	1.000A
SDT4483	N	S	SOL	211	To 5	80	40	5.0	5.000A	1.250W	200J	70.000G	1UA	60V	35	1.000A
SDT4551	N	S	SOL	490	490A	100	80	8.0	5.000A	20.000W	200J	70.000G	1UA	60V	70	1.000A
SDT4552	N	S	SOL	490	490A	100	80	8.0	5.000A	20.000W	200J	70.000G	1UA	60V	70	1.000A
SDT4553	N	S	SOL	490	490A	80	40	8.0	5.000A	20.000W	200J	70.000G	1UA	60V	35	1.000A
SDT4554	N	S	SOL	490	490A	100	80	8.0	5.000A	20.000W	200J	70.000G	1UA	60V	70	1.000A
SDT4555	N	S	SOL	490	490A	100	80	8.0	5.000A	20.000W	200J	70.000G	1UA	60V	70	1.000A
SDT4556	N	S	SOL	490	490A	100	80	8.0	5.000A	20.000W	200J	70.000G	1UA	60V	150	1.000A
SDT4583	N	S	SOL	490	490A	80	40	5.0	5.000A	20.000W	200J	70.000G	1UA	60V	35	1.000A
SDT4901	N	S	SOL	211	To 5	225	200	8.0	5.000A	4.000W	200J	40.000G	1UA	100V	35	1.000A
SDT4902	N	S	SOL	211	To 5	250	225	8.0	5.000A	4.000W	200J	40.000G	1UA	100V	35	1.000A
SDT4903	N	S	SOL	211	To 5	300	275	8.0	5.000A	4.000W	200J	40.000G	1UA	100V	35	1.000A
SDT4904	N	S	SOL	605	To 5	325	300	8.0	5.000A	4.000W	200J	40.000G	1UA	100V	35	1.000A
SDT4905	N	S	SOL	605	To 66	225	200	8.0	5.000A	20.000W	200J	40.000G	1UA	100V	35	1.000A
SDT4921	N	S	SOL	605	To 66	225	225	8.0	5.000A	20.000W	200J	40.000G	1UA	100V	35	1.000A
SDT4922	N	S	SOL	605	To 66	275	250	8.0	5.000A	20.000W	200J	40.000G	1UA	100V	35	1.000A
SDT4923	N	S	SOL	605	To 66	300	275	8.0	5.000A	20.000W	200J	40.000G	1UA	100V	35	1.000A
SDT4924	N	S	SOL	605	To 66	325	300	8.0	5.000A	20.000W	200J	40.000G	1UA	100V	35	1.000A
SDT4925	N	S	SOL	211	To 46	80	60	8.0	2.000A	4.000W	200J	85.000G	100NA	30V	88	500A
SDT5001	N	S	SOL	211	To 46	100	80	8.0	2.000A	4.000W	200J	85.000G	100NA	30V	88	500A
SDT5002	N	S	SOL	211	To 46	140	100	8.0	2.000A	4.000W	200J	85.000G	100NA	30V	88	500A
SDT5003	N	S	SOL	211	To 46	180	120	8.0	2.000A	4.000W	200J	85.000G	100NA	30V	88	500A
SDT5004	N	S	SOL	211	To 46	80	60	8.0	2.000A	4.000W	200J	85.000G	100NA	30V	88	500A
SDT5005	N	S	SOL	211	To 46	100	80	8.0	2.000A	4.000W	200J	85.000G	100NA	30V	88	500A
SDT5006	N	S	SOL	211	To 46	140	100	8.0	2.000A	4.000W	200J	85.000G	100NA	30V	88	500A
SDT5007	N	S	SOL	211	To 46	180	120	8.0	2.000A	4.000W	200J	85.000G	100NA	30V	88	500A
SDT5008	N	S	SOL	211	To 46	80	60	8.0	2.000A	4.000W	200J	85.000G	100NA	30V	88	500A
SDT5009	N	S	SOL	211	To 46	100	80	8.0	2.000A	4.000W	200J	85.000G	100NA	30V	88	500A
SDT5010	N	S	SOL	211	To 46	140	100	8.0	2.000A	4.000W	200J	85.000G	100NA	30V	88	500A
SDT5011	N	S	SOL	211	To 46	180	120	8.0	2.000A	4.000W	200J	85.000G	100NA	30V	88	500A
SDT5012	N	S	SOL	211	To 46	80	60	8.0	2.000A	4.000W	200J	85.000G	100NA	30V	88	500A
SDT5013	N	S	SOL	211	To 46	100	80	8.0	2.000A	4.000W	200J	85.000G	100NA	30V	88	500A
SDT5014	N	S	SOL	211	To 46	140	100	8.0	2.000A	4.000W	200J	85.000G	100NA	30V	88	500A
SDT5015	N	S	SOL	211	To 46	180	120	8.0	2.000A	4.000W	200J	85.000G	100NA	30V	88	500A
SDT5052	N	S	SOL	211	To 46	75	150	8.0	2.000A	4.000W	200J	85.000G	100NA	60V	88	500A
SDT5053	N	S	SOL	211	To 46	200	175	8.0	2.000A	4.000W	200J	85.000G	100NA	60V	88	500A
SDT5054	N	S	SOL	211	To 46	225	200	8.0	2.000A	4.000W	200J	85.000G	100NA	60V	88	500A
SDT5055	N	S	SOL	211	To 46	175	150	8.0	2.000A	4.000W	200J	85.000G	100NA	60V	45	500A
SDT5056	N	S	SOL	211	To 46	225	200	8.0	2.000A	4.000W	200J	85.000G	100NA	60V	45	500A
SDT5501	N	S	SOL	211	To 5	60	40	8.0	2.000A	4.000W	200J	85.000G	100NA	30V	88	500A
SDT5502	N	S	SOL	211	To 5	80	60	8.0	2.000A	4.000W	200J	85.000G	100NA	30V	88	500A
SDT5503	N	S	SOL	211	To 5	100	80	8.0	2.000A	4.000W	200J	85.000G	100NA	30V	88	500A
SDT5504	N	S	SOL	211	To 5	140	100	8.0	2.000A	4.000W	200J	85.000G	100NA	30V	88	500A
SDT5505	N	S	SOL	211	To 5	180	140	8.0	2.000A	4.000W	200J	85.000G	100NA	30V	88	500A
SDT5506	N	S	SOL	211	To 5	60	40	8.0	2.000A	4.000W	200J	85.000G	100NA	30V	88	500A
SDT5507	N	S	SOL	211	To 5	80	60	8.0	2.000A	4.000W	200J	85.000G	100NA	30V	88	500A
SDT5508	N	S	SOL	211	To 5	100	80	8.0	2.000A	4.000W	200J	85.000G	100NA	30V	88	500A
SDT5509	N	S	SOL	211	To 5	140	100	8.0	2.000A	4.000W	200J	85.000G	100NA	30V	88	500A
SDT5510	N	S	SOL	211	To 5	180	140	8.0	2.000A	4.000W	200J	85.000G	100NA	30V	88	500A
SDT5511	N	S	SOL	211	To 5	60	40	8.0	2.000A	4.000W	200J	85.000G	100NA	30V	88	500A
SDT5512	N	S	SOL	211	To 5	80	60	8.0	2.000A	4.000W	200J	85.000G	100NA	30V	88	500A
SDT5513	N	S	SOL	211	To 5	100	80	8.0	2.000A	4.000W	200J	85.000G	100NA	30V	88	500A
SDT5514	N	S	SOL	211	To 5	140	100	8.0	2.000A	4.000W	200J	85.000G	100NA	30V	88	500A
SDT5515	N	S	SOL	211	To 5	180	140	8.0	2.000A	4.000W	200J	85.000G	100NA	30V	88	500A
SDT5551	N	S	SOL	211	To 5	175	150	8.0	2.000A	4.000W	200J	85.000G	100NA	60V	88	500A
SDT5552	N	S	SOL	211	To 5	200	175	8.0	2.000A	4.000W	200J	85.000G	100NA	60V	88	500A
SDT5553	N	S	SOL	211	To 5	225	200	8.0	2.000A	4.000W	200J	85.000G	100NA	60V	88	500A
SDT5554	N	S	SOL	211	To 5	175	150	8.0	2.000A	4.000W	200J	85.000G	100NA	60V	88	500A
SDT5555	N	S	SOL	211	To 5	200	175	8.0	2.000A	4.000W	200J	85.000G	100NA	60V	88	500A
SDT5556	N	S	SOL	211	To 5	225	200	8.0	2.000A	4.000W	200J	85.000G	100NA	60V	88	500A
SDT5901	N	S	SOL	605	To 3	225	40	8.0	2.000A	16.600W	200J	85.000G	100NA	60V	45	500A
SDT5902	N	S	SOL	605	To 3	80	60	8.0	2.000A	16.600W	200J	85.000G	100NA	30V	88	500A
SDT5903	N	S	SOL	605	To 3	100	80	8.0	2.000A	16.600W	200J	85.000G	100NA	30V	88	500A
SDT5904	N	S	SOL	605	To 3	140	100	8.0	2.000A	16.600W	200J	85.000G	100NA	30V	88	500A
SDT5905	N	S	SOL	605	To 3	180	120	8.0	2.000A	16.600W	200J	85.000G	100NA	30V	88	500A
SDT5906	N	S	SOL	605	To 3	60	40	8.0	2.000A	16.600W	200J	85.000G	100NA	30V	88	500A
SDT5907	N	S	SOL	605	To 3	80	60	8.0	2.000A	16.600W	200J	85.000G	100NA	30V	88	500A
SDT5908	N	S	SOL	605	To 3	100	80	8.0	2.000A	16.600W	200J	85.000G	100NA	30V	88	500A
SDT5909	N	S	SOL	605	To 3	140	100	8.0	2.000A	16.600W	200J	85.000G	100NA	30V	88	500A
SDT5910	N	S	SOL	605	To 3	180	120	8.0	2.000A	16.600W	200J	85.000G	100NA	30V	88	500A
SDT5911	N	S	SOL	605	To 3	60	40	8.0	2.000A	16.600W	200J	85.000G	100NA	30V	88	500A
SDT5912	N	S	SOL	605	To 3	80	60	8.0	2.000A	16.600W	200J	85.000G	100NA	30V	88	500A
SDT5913	N	S	SOL	605	To 3	100	80	8.0	2.000A	16.600W	200J	85.000G	100NA	30V	88	500A
SDT5914	N	S	SOL	605	To 3	140	100	8.0	2.000A	16.600W	200J	85.000G	100NA	30V	88	500A

Transistor Type No.	N P S	C S	Manufacturer	Lead Ident	Out- line	Maximum (V)			Maximum		Max. T.(°C)	Frequency Resp.(MHz)	Leakage		Gain	
						V _{CE}	V _{BE}	V _{ES}	I _C	Power			I _{CE}	I _{CB}	V _{CE}	h _{FE}
SDT6410	N	S	SOL	568	T0111	100	80	8.0	5.000A	30.000W	200J	70.000G	1UA	60V	35	1.000A
SDT6411	N	S	SOL	568	T0111	60	40	8.0	5.000A	30.000W	200J	70.000G	1UA	60V	70	1.000A
SOT6412	N	S	SOL	568	T0111	80	60	8.0	5.000A	30.000W	200J	70.000G	1UA	60V	70	1.000A
SOT6413	N	S	SOL	568	T0111	100	80	8.0	5.000A	30.000W	200J	70.000G	1UA	60V	50	1.000A
SOT6414	N	S	SOL	568	T0111	60	40	8.0	5.000A	30.000W	200J	70.000G	1UA	60V	150	1.000A
SDT6415	N	S	SOL	568	T0111	100	80	8.0	5.000A	30.000W	200J	70.000G	1UA	60V	150	1.000A
SOT6416	N	S	SOL	568	T0111	60	40	8.0	5.000A	30.000W	200J	70.000G	1UA	60V	150	1.000A
SOT6901	N	S	SOL	605	T0 66	145	125	8.0	5.000A	20.000W	200J	20.000G	1UA	60V	35	1.000A
SDT6902	N	S	SOL	605	T0 66	170	150	8.0	5.000A	20.000W	200J	20.000G	1UA	60V	35	1.000A
SOT6903	N	S	SOL	605	T0 66	190	175	8.0	5.000A	20.000W	200J	20.000G	1UA	60V	35	1.000A
SOT6904	N	S	SOL	605	T0 66	220	200	8.0	5.000A	20.000W	200J	20.000G	1UA	60V	35	1.000A
SOT6905	N	S	SOL	605	T0 66	145	125	8.0	5.000A	20.000W	200J	20.000G	1UA	60V	70	1.000A
SOT6906	N	S	SOL	605	T0 66	170	150	8.0	5.000A	20.000W	200J	20.000G	1UA	60V	70	1.000A
SOT6907	N	S	SOL	605	T0 66	195	175	8.0	5.000A	20.000W	200J	20.000G	1UA	60V	70	1.000A
SOT6908	N	S	SOL	605	T0 66	220	200	8.0	5.000A	20.000W	200J	20.000G	1UA	60V	70	1.000A
SOT6909	N	S	SOL	561	T0 61	60	40	5.0	10.000A	50.000W	200J	60.000G	1UA	60V	15	5.000A
SOT7011	N	S	SOL	561	T0 61	80	60	5.0	10.000A	50.000W	200J	60.000G	1UA	60V	35	5.000A
SOT7012	N	S	SOL	561	T0 61	100	80	5.0	10.000A	50.000W	200J	60.000G	1UA	60V	70	5.000A
SOT7013	N	S	SOL	561	T0 61	60	40	5.0	10.000A	50.000W	200J	60.000G	1UA	60V	70	5.000A
SOT7014	N	S	SOL	561	T0 61	80	60	5.0	10.000A	50.000W	200J	60.000G	1UA	60V	70	5.000A
SOT7015	N	S	SOL	561	T0 61	100	80	5.0	10.000A	50.000W	200J	60.000G	1UA	60V	70	5.000A
SOT7016	N	S	SOL	561	T0 61	60	40	5.0	10.000A	50.000W	200J	60.000G	1UA	60V	70	5.000A
SOT7017	N	S	SOL	561	T0 61	80	60	5.0	10.000A	50.000W	200J	60.000G	1UA	60V	70	5.000A
SOT7018	N	S	SOL	561	T0 61	100	80	5.0	10.000A	50.000W	200J	60.000G	1UA	60V	70	5.000A
SOT7019	N	S	SOL	561	T0 61	60	40	5.0	10.000A	50.000W	200J	60.000G	1UA	60V	150	5.000A
SOT7140	N	S	SOL	561	T0 61	120	100	5.0	10.000A	50.000W	200J	60.000G	1000A	100V	70	5.000A
SOT7141	N	S	SOL	561	T0 61	200	150	5.0	10.000A	50.000W	200J	50.000G	1000A	100V	70	5.000A
SOT7150	N	S	SOL	561	T0 61	140	120	5.0	10.000A	50.000W	200J	50.000G	5000A	100V	35	5.000A
SOT7151	N	S	SOL	561	T0 61	170	150	5.0	10.000A	50.000W	200J	50.000G	5000A	100V	35	5.000A
SOT7152	N	S	SOL	561	T0 61	190	175	5.0	10.000A	50.000W	200J	50.000G	5000A	100V	35	5.000A
SOT7153	N	S	SOL	561	T0 61	220	200	5.0	10.000A	50.000W	200J	50.000G	5000A	100V	35	5.000A
SOT7154	N	S	SOL	561	T0 61	140	100	5.0	10.000A	50.000W	200J	50.000G	5000A	100V	70	5.000A
SOT7155	N	S	SOL	561	T0 61	170	150	5.0	10.000A	50.000W	200J	50.000G	5000A	100V	70	5.000A
SOT7156	N	S	SOL	561	T0 61	220	200	5.0	10.000A	50.000W	200J	50.000G	5000A	100V	70	5.000A
SOT7202	N	S	SOL	605	T0 66	225	200	8.0	10.000A	65.000W	200J	50.000G	1UA	100V	35	5.000A
SOT7203	N	S	SOL	605	T0 66	275	250	8.0	10.000A	65.000W	200J	50.000G	1UA	100V	35	5.000A
SOT7204	N	S	SOL	605	T0 66	325	300	8.0	10.000A	65.000W	200J	50.000G	1UA	100V	35	5.000A
SOT7205	N	S	SOL	605	T0 66	370	325	8.0	10.000A	65.000W	200J	50.000G	1UA	100V	35	5.000A
SOT7206	N	S	SOL	605	T0 66	315	150	8.0	10.000A	65.000W	200J	50.000G	10UA	100V	15	5.000A
SOT7207	N	S	SOL	605	T0 66	320	200	8.0	10.000A	65.000W	200J	50.000G	10UA	100V	22	5.000A
SOT7208	N	S	SOL	605	T0 66	350	250	8.0	10.000A	65.000W	200J	50.000G	10UA	100V	22	5.000A
SOT7209	N	S	SOL	605	T0 66	300	300	8.0	10.000A	65.000W	200J	50.000G	10UA	100V	22	5.000A
SOT7401	N	S	SOL	561	T0 61	40	40	5.0	10.000A	5.000W	200J	15.000G	1UA	30V	70	5.000A
SOT7402	N	S	SOL	211	T0 5	80	60	5.0	10.000A	5.000W	200J	15.000G	1UA	60V	70	5.000A
SOT7403	N	S	SOL	211	T0 5	100	80	5.0	10.000A	5.000W	200J	15.000G	1UA	60V	70	5.000A
SOT7411	N	S	SOL	211	T0 5	60	40	5.0	10.000A	5.000W	200J	15.000G	1UA	60V	35	5.000A
SOT7412	N	S	SOL	211	T0 5	80	60	5.0	10.000A	5.000W	200J	15.000G	1UA	60V	35	5.000A
SOT7413	N	S	SOL	211	T0 5	100	80	5.0	10.000A	5.000W	200J	15.000G	1UA	60V	35	5.000A
SOT7414	N	S	SOL	211	T0 5	60	40	5.0	10.000A	5.000W	200J	15.000G	1UA	30V	70	5.000A
SOT7415	N	S	SOL	211	T0 5	80	60	5.0	10.000A	5.000W	200J	15.000G	1UA	60V	70	5.000A
SOT7416	N	S	SOL	211	T0 5	100	80	5.0	10.000A	5.000W	200J	15.000G	1UA	60V	70	5.000A
SOT7417	N	S	SOL	211	T0 5	40	40	5.0	10.000A	5.000W	200J	15.000G	1UA	30V	150	5.000A
SOT7418	N	S	SOL	211	T0 5	80	60	5.0	10.000A	5.000W	200J	15.000G	1UA	60V	150	5.000A
SOT7419	N	S	SOL	211	T0 5	100	80	5.0	10.000A	5.000W	200J	15.000G	1UA	60V	150	5.000A
SDT7601	N	S	SOL	605	T0 66	300	300	8.0	10.000A	65.000W	200J	60.000G	5000A	30V	70	5.000A
SDT7602	N	S	SOL	605	T0 66	350	325	8.0	10.000A	65.000W	200J	60.000G	5000A	30V	70	5.000A
SOT7603	N	S	SOL	605	T0 66	100	80	8.0	10.000A	65.000W	200J	60.000G	5000A	60V	70	5.000A
SOT7604	N	S	SOL	605	T0 66	140	120	8.0	10.000A	65.000W	200J	60.000G	5000A	60V	70	5.000A
SOT7605	N	S	SOL	605	T0 66	170	150	8.0	10.000A	65.000W	200J	60.000G	5000A	100V	70	5.000A
SOT7607	N	S	SOL	605	T0 66	60	40	8.0	10.000A	65.000W	200J	60.000G	5000A	30V	35	5.000A
SOT7608	N	S	SOL	605	T0 66	80	60	8.0	10.000A	65.000W	200J	60.000G	5000A	30V	35	5.000A
SOT7609	N	S	SOL	605	T0 66	100	80	8.0	10.000A	65.000W	200J	60.000G	5000A	60V	35	5.000A
SOT7610	N	S	SOL	605	T0 66	140	100	8.0	10.000A	65.000W	200J	60.000G	5000A	60V	35	5.000A
SOT7611	N	S	SOL	605	T0 66	170	150	8.0	10.000A	65.000W	200J	60.000G	5000A	100V	35	5.000A
SOT7612	N	S	SOL	605	T0 66	220	200	8.0	10.000A	65.000W	200J	60.000G	5000A	100V	35	5.000A
SOT7801	N	S	SOL	561	T0 61	225	200	8.0	10.000A	50.000W	200J	50.000G	1UA	100V	35	5.000A
SOT7802	N	S	SOL	561	T0 61	250	225	8.0	10.000A	50.000W	200J	50.000G	1UA	100V	35	5.000A
SOT7803	N	S	SOL	561	T0 61	275	250	8.0	10.000A	50.000W	200J	50.000G	1UA	100V	35	5.000A
SDT7804	N	S	SOL	561	T0 61	325	300	8.0	10.000A	50.000W	200J	50.000G	1UA	100V	35	5.000A
SDT7805	N	S	SOL	561	T0 61	375	300	8.0	10.000A	50.000W	200J	50.000G	1UA	100V	35	5.000A
SOT7806	N	S	SOL	561	T0 61	150	150	8.0	10.000A	50.000W	200J	50.000G	10UA	100V	15	5.000A
SOT7807	N	S	SOL	561	T0 61	200	200	8.0	10.000A	50.000W	200J	50.000G	10UA	100V	22	5.000A
SOT7808	N	S	SOL	561	T0 61	250	250	8.0	10.000A	50.000W	200J	50.000G	10UA	100V	22	5.000A
SDT7809	N	S	SOL	561	T0 61	300	300	8.0	10.000A	50.000W	200J	50.000G	10UA	100V	22	5.000A
SOT7901	N	S	SOL	605	T0 66	225	200	8.0	10.000A	25.000W	200J	50.000G	1UA	100V	35	5.000A
SDT7902	N	S	SOL	605	T0 66	275	250	8.0	10.000A	25.000W	200J	50.000G	1UA	100V	35	5.000A
SDT7903	N	S	SOL	605	T0 66	325	300	8.0	10.000A	25.000W	200J	50.000G	1UA	100V	35	5.000A
SDT7904	N	S	SOL	605	T0 66	375	300	8.0	10.000A	25.000W	200J	50.000G	1UA	100V	35	5.000A
SDT7905	N	S	SOL	605	T0 66	200	200	8.0	10.000A	25.000W	200J	50.000G	10UA	100V	22	5.000A
SDT7907	N	S	SOL	605	T0 66	250	250	8.0	10.000A	25.000W	200J	50.000G	10UA	100V	22	5.000A
SDT																

Transistor Type No.	N P	G S	Manufacturer	Lead Ident	Out- line	Maximum (V)			Maximum		Max. T.(°C)	Frequency Resp.(MHz)	Leakage I_{B0} @ V_{CB}	Gain h_{FE} @ I_C	
						V_{BE}	V_{CE}	V_{CB}	I_C	Power					
SF.T143	P	G	CSF	181	181A	45	20	25.0	5.00A	.350W	100J	.400B	20UA	45V	30
SF.T144	P	G	CSF	181	181A	45	20	25.0	5.00A	.350W	100J	.600B	20UA	45V	60
SF.T145	P	G	CSF	775	775A	45	20	25.0	5.00A	.550W	100J	.400E	20UA	45V	30
SF.T146	P	G	CSF	775	775A	45	20	25.0	5.00A	.550W	100J	.600E	20UA	45V	60
SF.T166	P	G	CSF	128	TO 44	15	5	5	.010A	.120W	85J	120.000G	15UA	15V	120
SF.T168	P	G	CSF	211	TO 5	120				.600W	200J	140.000G	200UA	60V	30
SF.T212	P	G	CSF	605	TO 3	30	15	5	3.000A	30.000W	85J	.700B	1MA	40V	80
SF.T213	P	G	CSF	605	TO 3	60	40	30.0	3.000A	45.000W	95J	.200B	1MA	60V	40
SF.T214	P	G	CSF	212	TO 5	30	24S	15.0	2.50A	.225W	100J	1.300B	15UA	30V	30
SF.T221	P	G	CSF	212	TO 5	30	24S	15.0	2.50A	.225W	100J	2.000B	15UA	30V	50
SF.T222	P	G	CSF	212	TO 5	30	24S	15.0	2.50A	.225W	100J	4.000B	15UA	30V	100
SF.T223	P	G	CSF	212	TO 5	30	24S	15.0	2.50A	.150W	100J	3.500G	10UA	40V	32
SF.T226	P	G	CSF	210	TO 5	30	24S	18.0	2.50A	.150W	100J	4.500G	10UA	30V	46
SF.T227	P	G	CSF	210	TO 5	24	20S	12.0	2.50A	.150W	100J	5.500G	10UA	24V	62
SF.T228	P	G	CSF	210	TO 5	18	15S	12.0	2.50A	.150W	100J	10.000G	10UA	18V	90
SF.T229	P	G	CSF	210	TO 5	18	15S	12.0	1.000A	.450W	85J	AUO	125UA	20V	60
SF.T232	P	G	CSF	211	TO 11	60	40	20.0	1.000A	.450W	85J	AUO	125UA	30V	60
SF.T233	P	G	CSF	211	TO 11	60	40	20.0	1.000A	.450W	85J	AUO	125UA	40V	60
SF.T234	P	G	CSF	210	TO 5	15	9.0		1.00A	.150W	100J	3.000B	2MA	2V	100
SF.T237	P	G	CSF	605	TO 3	40	30	20.0	6.000A	45.000W	95J	.200B	3MA	40V	40
SF.T238	P	G	CSF	605	TO 3	60	40	30.0	6.000A	45.000W	95J	.200B	3MA	60V	40
SF.T239	P	G	CSF	605	TO 3	80	60	40.0	6.000A	45.000W	95J	.200B	3MA	80V	40
SF.T240	P	G	CSF	212	TO 5	60	35S	25.0	5.00A	.225W	100J	2.000B	15UA	60V	40
SF.T243	P	G	CSF	605	TO 3	80	60	40.0	6.000A	45.000W	95J	.200B	1MA	80V	90
SF.T250	P	G	CSF	605	TO 3	80	60	40.0	3.000A	45.000W	95J	.200B	8MA	30V	60
SF.T264	P	G	CSF	405	TO 36	40	15	15.0	15.000A	70.000W	95J	.300B	8MA	40V	50
SF.T265	P	G	CSF	405	TO 36	40	15	15.0	15.000A	70.000W	95J	.300B	8MA	60V	50
SF.T266	P	G	CSF	405	TO 36	60	50	40.0	15.000A	70.000W	95J	.300B	8MA	60V	50
SF.T267	P	G	CSF	405	TO 36	60	60	60.0	15.000A	70.000W	95J	.300B	8MA	60V	50
SF.T288	P	G	CSF	210	TO 5	24	12.0		5.00A	.150W	100J	7.000B	10UA	24V	70
SF.T298	P	G	CSF	212	TO 1	18	15	12.0	.100A	.150W	100J	8.000G	10UA	30V	70
SF.T306	P	G	CSF	120	TO 1	18	15	12.0	.100A	.150W	100J	3.000B	10UA	15V	40
SF.T307	P	G	CSF	120	TO 1	18	15	12.0	.100A	.150W	100J	7.000B	10UA	15V	80
SF.T308	P	G	CSF	120	TO 1	18	15	12.0	.100A	.150W	100J	13.000B	10UA	15V	100
SF.T315	P	G	CSF	120	TO 1	18	15	12.0	.100A	.150W	100J	18.000G	10UA	12V	90
SF.T316	P	G	CSF	128	TO 44	20	5	5	.010A	.120W	85J	60.000G	15UA	15V	120
SF.T317	P	G	CSF	120	TO 1	20	5	5	.010A	.150W	100J	40.000G	15UA	15V	100
SF.T319	P	G	CSF	120	TO 1	20	5	5	.010A	.150W	100J	15.000G	15UA	15V	80
SF.T320	P	G	CSF	120	TO 1	20	5	5	.010A	.150W	100J	35.000G	15UA	15V	80
SF.T322	P	G	CSF	120	TO 1	24	20	12.0	.250A	.200W	100J	1.600B	15UA	24V	50
SF.T323	P	G	CSF	120	TO 1	24	20	12.0	.250A	.200W	100J	2.600B	15UA	24V	100
SF.T337	P	G	CSF	120	TO 1	15	15	9.0	.100A	.150W	85J	3.000B	3UA	3V	120
SF.T352	P	G	CSF	120	TO 1	24	20	2.0	.150A	.200W	100J	1.600B	15UA	24V	58
SF.T353	P	G	CSF	120	TO 1	24	20	2.0	.150A	.200W	100J	2.400B	15UA	24V	92
SF.T354	P	G	CSF	128	TO 44	20	5	5	.010A	.120W	85J	65.000G	15UA	15V	120
SF.T357	P	G	CSF	128	TO 44	20	5	5	.010A	.120W	85J	85.000G	15UA	15V	120
SF.T357P	P	G	CSF	128	TO 44	30	10	5	.010A	.120W	85J	60.000G	15UA	15V	120
SF.T358	P	G	CSF	128	TO 44	20	5	5	.010A	.120W	85J	110.000G	15UA	15V	120
SHA7520	P	S	SOL	903	903A	35	35	35.0	1.000W	160J	160J	.800B	100NA	10V	.001A
SHA7521	P	S	SOL	903	903A	60	60	60.0	1.000W	160J	160J	.800B	100NA	10V	.001A
SHA7522	P	S	SOL	903	903A	15	15	15.0	1.000W	160J	160J	.800B	100NA	22	.001A
SHA7523	P	S	SOL	903	903A	35	35	35.0	1.000W	160J	160J	.800B	100NA	22	.001A
SHA7524	P	S	SOL	903	903A	60	60	60.0	1.000W	160J	160J	.800B	100NA	22	.001A
SHA7525	P	S	SOL	903	903A	110	110	110.0	1.000W	160J	160J	.800B	100NA	44	.001A
SHA7526	P	S	SOL	903	903A	15	15	15.0	1.000W	160J	160J	.800B	100NA	44	.001A
SHA7527	P	S	SOL	903	903A	35	35	35.0	1.000W	160J	160J	.800B	100NA	44	.001A
SHA7528	P	S	SOL	903	903A	60	60	60.0	1.000W	160J	160J	.800B	100NA	44	.001A
SHA7529	P	S	SOL	903	903A	90	90	90.0	1.000W	160J	160J	.800B	100NA	22	.001A
SHA7530	P	S	SOL	211	TO 5	35	35	35.0	4.00W			.800B	100NA	10V	.001A
SHA7531	P	S	SOL	211	TO 5	60	60	60.0	4.00W			.800B	100NA	10V	.001A
SHA7532	P	S	SOL	211	TO 5	15	15	15.0	4.00W			.800B	100NA	22	.001A
SHA7533	P	S	SOL	211	TO 5	15	15	15.0	4.00W			.800B	100NA	22	.001A
SHA7534	P	S	SOL	211	TO 5	35	35	35.0	4.00W			.800B	100NA	22	.001A
SHA7535	P	S	SOL	211	TO 5	110	110	110.0	4.00W			.800B	100NA	44	.001A
SHA7536	P	S	SOL	211	TO 5	15	15	15.0	4.00W			.800B	100NA	44	.001A
SHA7537	P	S	SOL	211	TO 5	35	35	35.0	4.00W			.800B	100NA	44	.001A
SHA7538	P	S	SOL	211	TO 5	60	60	60.0	4.00W			.800B	100NA	44	.001A
SHA7539	P	S	SOL	211	TO 5	90	90	90.0	4.00W			.800B	100NA	22	.001A
SHA7597	P	S	SOL	903	903A	50	40	20.0	1.000W	160J	160J	.800B	100NA	14	.001A
SHA7598	P	S	SOL	903	903A	50	35	20.0	1.000W	160J	160J	.800B	100NA	29	.001A
SHA7599	P	S	SOL	903	903A	50	30	20.0	1.000W	160J	160J	.800B	100NA	58	.001A
SK3003	P	G	RCA	120	TO 1	9			5.00A	.150W		AUO			
SK3004	P	G	RCA	120	TO 1	15			5.00A	.150W		AUO			
SK3005	P	G	RCA	120	TO 1	12			0.05A	.250W		RF AMP			
SK3006	P	G	RCA	75	TO 45	15			0.05A	.250W		FM F			
SK3007	P	G	RCA	120	TO 1	15			0.05A	.250W		30.000G			
SK3008	P	G	RCA	120	TO 1	15				.250W		RF AMP			
SK3009	P	G	RCA	605	TO 3		50		10.000A	30.000W					
SK3010	P	G	RCA	120	TO 1	15			1.00A	.150W		RF AMP			
SK3011	P	G	RCA	120	TO 1	18			5.00A	.150W		AUO			
SK3012	P	G	RCA	405	TO 36	15			7.500A	150.000W		AUO			
SK3013	P	G	M.P. SK3009	605	TO 3		50	1.5	5.000A	12.500W		AUO			
SK3015	N	S	RCA	217	TO 72	25						800.000G			
SK3018	N	S	RCA	210	TO 72							UHFOSC			
SK3019	N	S	RCA	217	TO 18	25			3.00A	.500W				150	.010A
SK3020	N	S	RCA	605	TO 3	300				8.000W		25.000G		50	
SK3021	N	S	RCA	211	TO 5	80						100.000G		80	
SK3024	N	S	RCA	211	TO 5	80						100.000G		80	
SK3025	N	S	RCA	605	TO 3		80					.800G			
SK3026	N	S	RCA	605	TO 3		80					.800G			
SK3027	N	S	RCA	605	TO 3		80					.800G			
SK3028	M.P.	P.	SK3026												
SK3029	M.P.	P.	SK3027												
SK3034	P	G	RCA	605	TO 3	36			3.000A	10.000W		HOR AMP			
SK3035	P	G	RCA	605	TO 3	36			10.000A	5.000W		HOR AMP			
SK3036	N	S	RCA	605	TO 3	80			20.000A	150.000W		.800G		15	15.000A
SK3037	N	S	M.P. SK3036	211	211M	140			.025A	.400W		1200.000G		200	.002A
SK3038	N	S	RCA	217	TO 72	15			.030A	.150W					

Transistor Type No.	N P	G S	Manufacturer	Lead Ident	Out- line	Maximum (V)			Maximum		Max. T.(°C)	Frequency Resp.(MHz)	Leakage I_{sat} @ V_{ce}	Gain h_{FE} @ I_c
						V_{ce}	V_{r1}	V_{r2}	I_c	Power				
SRF12212			SEE RF POWER SECTION											
SRF32214			SEE RF POWER SECTION											
ST400	N	S	TEC	561	TO 61	60	60	10.0		78.000W	200J	12.000G	10MA 60V	40
ST401	N	S	TEC	561	TO 61	45	45	5.0		78.000W	200J	12.000G	20MA 45V	44
ST440	N	S	TEC	731	TO 53	60	60	5.0		60.000W	150J	4.000B	20MA 60V	25
ST450	N	S	TEC	561	TO 61	60	60	5.0		600.000W	150J	4.000B	20MA 60V	25
ST4150	N	S	TEC	210	TO 5	60	60	6.0		.600W	200J	8.000G	15UA 60V	25
ST4201	N	S	TEC	210	TO 5	45	45	4.0		.600W	200J		15UA 30V	24
ST4202	N	S	TEC	210	TO 5	45	45	4.0		.600W	200J		15UA 30V	24
ST4203	N	S	TEC	210	TO 5	45	45	4.0		.600W	200J		15UA 30V	24
ST4540	N	S	TEC	210	TO 5	75	75	4.0		.600W	200J		15UA 30V	60
ST5641	N	S	TEC	211	TO 18	30	25			.600W	200J		15UA 30V	60
ST1200	N	S	TEC	561	TO 61	80	80							75
ST10000	P	S	TEC	561	TO 18	60	30			360W		60.000G	2NA 45V	600
ST10001	P	S	TEC	561	TO 61	100	100			10.000A 50.000W				30
ST14000	N	S	TEC	561	TO 63	80	80			80.000A 200.000W				30
ST14000A	N	S	TEC	561	TO 63	100	100			80.000A 200.000W				30
ST14011	N	S	TEC	561	TO 63	100	60			200.000W		10.000G	10UA 80V	90
ST14012	N	S	TEC	561	TO 63	125	80			200.000W		10.000G	10UA 100V	90
ST14013	N	S	TEC	561	TO 63	150	100			200.000W		10.000G	10UA 120V	90
ST15013	N	S	TEC	561	TO 63	100	60			125.000W		10.000G	10UA 80V	90
ST15014	N	S	TEC	561	TO 63	125	80			40.000A 125.000W		10.000G	10UA 100V	90
ST15015	N	S	TEC	561	TO 63	145	100	10.0		40.000A 187.000W		10.000G	100UA 100V	50
ST15043	N	S	TEC	561	TO 63	170	120	10.0		40.000A 187.000W		10.000G	100UA 120V	50
ST15044	N	S	TEC	561	TO 63	170	120	10.0		40.000A 187.000W		10.000G	100UA 120V	50
ST15045	N	S	TEC	561	TO 63	170	120	10.0		40.000A 187.000W		10.000G	100UA 120V	50
ST17003	N	S	TEC	561	TO 63	80	80			20.000A 50.000W		10.000G	100UA 135V	50
ST17004	N	S	TEC	561	TO 63	100	100			20.000A 50.000W				30
ST17060	N	S	TEC	561	TO 61	125	80	10.0		30.000A 150.000W		10.000G	100UA 100V	50
ST17061	N	S	TEC	561	TO 61	145	80	10.0		30.000A 150.000W		10.000G	100UA 120V	50
ST17062	N	S	TEC	561	TO 61	170	120	10.0		30.000A 150.000W		10.000G	100UA 135V	50
ST18007	N	S	TEC	561	TO 63	375	375			2.000A 100.000W				30
ST18008	N	S	TEC	561	TO 63	300	300			2.000A 100.000W				30
ST18009	N	S	TEC	561	TO 63	250	250			2.000A 100.000W				30
ST18010	N	S	TEC	561	TO 63	200	200			2.000A 100.000W				30
ST18011	N	S	TEC	561	TO 61	375	375			10.000A 50.000W				30
ST18012	N	S	TEC	561	TO 61	250	250			10.000A 50.000W				30
ST18013	N	S	TEC	561	TO 61	200	200			10.000A 50.000W				30
ST18014	N	S	TEC	561	TO 61	150	150			10.000A 50.000W				30
ST18015	N	S	TEC	561	TO 59	375	375			5.000A 30.000W				30
ST18016	N	S	TEC	561	TO 59	300	300			5.000A 30.000W				30
ST18017	N	S	TEC	561	TO 59	250	250			5.000A 30.000W				30
ST18018	N	S	TEC	561	TO 59	200	200			5.000A 30.000W				30
ST40000	P	S	TEC	561	TO 59	80	80			5.000A 30.000W				30
ST40001	P	S	TEC	561	TO 63	80	80			40.000A 100.000W				30
ST54000	P	S	TEC	561	TO 63	80	80			20.000A 100.000W				30
ST54001	P	S	TEC	561	TO 63	100	100			20.000A 100.000W				30
ST61000	P	S	TEC	211	TO 18	40	35			2.000A 30.000W				150
ST72000	P	S	TEC	561	TO 59	80	80			2.000A 30.000W				75
ST72000A	P	S	TEC	561	TO 59	100	100			2.000A 30.000W				150
ST72011	P	S	TEC	561	TO 59	40	40			30.000W		30.000G	1UA 30V	80
ST72012	P	S	TEC	561	TO 59	60	60			30.000W		30.000G	1UA 40V	80
ST72013	P	S	TEC	561	TO 59	80	80			30.000W		30.000G	1UA 60V	80
ST72014	P	S	TEC	561	TO 59	100	100			30.000W		30.000G	1UA 80V	80
ST72015	P	S	TEC	561	TO 61	60	60			50.000W		30.000G	1UA 60V	1,500A
ST72016	P	S	TEC	561	TO 61	80	80			50.000W		10.000G	10UA 60V	80
ST72017	P	S	TEC	561	TO 61	100	100			50.000W		10.000G	10UA 80V	80
ST72018	P	S	TEC	561	TO 63	40	40			100.000W		10.000G	10UA 30V	70
ST72019	P	S	TEC	561	TO 63	60	60			100.000W		10.000G	10UA 40V	70
ST72020	P	S	TEC	561	TO 63	80	80			100.000W		10.000G	10UA 60V	70
ST72021	P	S	TEC	561	TO 63	100	100			100.000W		10.000G	10UA 80V	70
ST74000	N	S	TEC	211	TO 5	125	80	10.0		2.000A 11.250W		10.000G	10UA 100V	50
ST74049	N	S	TEC	211	TO 5	145	100	10.0		2.000A 11.250W		10.000G	10UA 120V	50
ST74050	N	S	TEC	211	TO 5	170	120	10.0		2.000A 11.250W		10.000G	10UA 135V	50
ST74051	N	S	TEC	211	TO 5	80	80			1.000A 10.000W				75
ST75000	P	S	TEC	211	TO 5	80	80			1.000A 10.000W				75
ST75001	P	S	TEC	211	TO 5	100	100			5.000A 30.000W				30
ST78006	N	S	TEC	561	TO 59	100	100			5.000A 5.000W				2,500A
ST78007	N	S	TEC	561	TO 59	100	100			5.000A 5.000W				80
ST84000	N	S	TEC	211	TO 5	170	120	10.0		1.000A 7.500W		10.000G	10UA 130V	70
ST84027	N	S	TEC	211	TO 5	190	140	10.0		1.000A 7.500W		10.000G	10UA 150V	70
ST84028	N	S	TEC	211	TO 5	220	180	10.0		1.000A 7.500W		10.000G	10UA 170V	70
ST84029	N	S	TEC	561	TO 61	125	80	10.0		5.000A 75.000W		10.000G	100UA 100V	50
ST86020	N	S	TEC	561	TO 61	145	100	10.0		5.000A 75.000W		10.000G	100UA 120V	50
ST86021	N	S	TEC	561	TO 61	170	120	10.0		5.000A 75.000W		10.000G	135V	50
ST86022	N	S	TEC	561	TO 59	100	100			2.000A 30.000W				105
ST90000	N	S	TEC	561	TO 59	100	100			5.000A 30.000W				115
ST91054	N	S	TEC	211	TO 5	125	80	10.0		5.000A 15.000W	200J	10.000G	20UA 100V	50
ST91055	N	S	TEC	211	TO 5	145	100	10.0		5.000A 15.000W	200J	10.000G	20UA 120V	50
ST91056	N	S	TEC	211	TO 5	170	120	10.0		5.000A 15.000W	200J	10.000G	20UA 135V	50
ST91057	N	S	TEC	561	TO 59	145	100	10.0		10.000A 60.000W	200J	10.000G	30UA 100V	50
ST91058	N	S	TEC	561	TO 59	145	100	10.0		10.000A 60.000W	200J	10.000G	30UA 120V	50
ST91059	N	S	TEC	561	TO 59	125	80	10.0		20.000A 45.000W	200J	10.000G	20UA 100V	50
ST92006	N	S	TEC	561	TO 59	145	100	10.0		20.000A 45.000W	200J	10.000G	20UA 120V	50
ST92007	N	S	TEC	561	TO 59	125	80	10.0		20.000A 45.000W	200J	10.000G	20UA 135V	50
ST92008	N	S	TEC	561	TO 63	80	80			30.000A 200.000W	200J		2MA 80V	24
ST92009	N	S	TEC	561	TO 63	100	100			30.000A 200.000W	200J		2MA 100V	24
ST92010	N	S	TEC	561	TO 63	125	100			30.000A				

Transistor Type No.	N P	G S	Manufacturer	Lead Ident	Out Time	Maximum (V)			Maximum		Max. T.(°C)	Frequency Resp.(MHz)	Leakage		Gain	
						V _{BE}	V _{CE}	V _{CE(sat)}	I _C	Power			I _{CEO}	V _{CE}	I _{CE}	I _{CE}
STC5112/I	P	S	STC	730	TO 53	40	40	10.0	2.000A	85.000W	200J		250UA	20V	36	.500A
STC5113/I	P	S	STC	730	TO 53	60	60	10.0	2.000A	85.000W	200J		250UA	30V	36	.500A
STC5114/I	P	S	STC	730	TO 53	80	80	10.0	2.000A	85.000W	200J		250UA	40V	36	.500A
STC5202	P	S	STC	171	TO 8	40	40	10.0	3.000A	25.000W	200J		250UA	20V	36	1.000A
STC5203	P	S	STC	171	TO 8	60	60	10.0	3.000A	25.000W	200J		250UA	30V	36	1.000A
STC5204	P	S	STC	171	TO 8	80	80	10.0	3.000A	25.000W	200J		250UA	40V	36	1.000A
STC5205	P	S	STC	171	TO 8	40	40	10.0	2.000A	25.000W	200J		250UA	20V	36	.500A
STC5206	P	S	STC	171	TO 8	60	60	10.0	2.000A	25.000W	200J		250UA	30V	36	.500A
STC5207	P	S	STC	171	TO 8	80	80	10.0	2.000A	25.000W	200J		250UA	40V	36	.500A
STC5519/I	P	S	STC	560	TO 61	40	40	10.0	3.000A	85.000W	200J		250UA	20V	36	1.000A
STC5520/I	P	S	STC	560	TO 61	60	60	10.0	3.000A	85.000W	200J		250UA	30V	36	1.000A
STC5521/I	P	S	STC	560	TO 61	80	80	10.0	3.000A	85.000W	200J		250UA	40V	36	1.000A
STC5522/I	P	S	STC	560	TO 61	40	40	10.0	2.000A	85.000W	200J		250UA	20V	36	.500A
STC5523/I	P	S	STC	560	TO 61	60	60	10.0	2.000A	85.000W	200J		250UA	30V	36	.500A
STC5524/I	P	S	STC	560	TO 61	80	80	10.0	2.000A	85.000W	200J		250UA	40V	36	.500A
STC5624	P	S	STC	211	TO 5	120	120	10.0	1.000A	8.750W	200J		250UA	60V	24	
STC5802	P	S	STC	631	TO 37	40	40	10.0	3.000A	17.500W	200J		250UA	20V	36	1.000A
STC5803	P	S	STC	631	TO 37	60	60	10.0	3.000A	17.500W	200J		250UA	30V	36	1.000A
STC5804	P	S	STC	631	TO 37	80	80	10.0	3.000A	17.500W	200J		250UA	40V	36	1.000A
STC5805	P	S	STC	631	TO 37	40	40	10.0	2.000A	17.500W	200J		250UA	20V	36	.500A
STC5806	P	S	STC	631	TO 37	60	60	10.0	2.000A	17.500W	200J		250UA	30V	36	.500A
STC6807	P	S	STC	631	TO 37	80	80	10.0	2.000A	17.500W	200J		250UA	40V	36	.500A
STC7844	N	S	STC	211	TO 5	150	150	10.0	3.000A	8.750W	200J		250UA	125V	40	
STC7645	N	S	STC	211	TO 5	180	180	10.0	3.000A	8.750W	200J		250UA	180V	38	
STT2400	N	S	STC	211	TO 5	150	150	12.0	7.500A	10.000W	200J	25.000G	1UA	60V	52	2.000A
STT2401	N	S	STC	211	TO 5	140	120	12.0	7.500A	10.000W	200J	25.000G	1UA	60V	52	2.000A
STT2402	N	S	STC	211	TO 5	140	120	12.0	7.500A	10.000W	200J	25.000G	1UA	60V	88	2.000A
STT2403	N	S	STC	211	TO 5	120	100	12.0	7.500A	10.000W	200J	25.000G	1UA	60V	52	2.000A
STT2404	N	S	STC	211	TO 5	100	80	12.0	7.500A	10.000W	200J	25.000G	1UA	60V	52	2.000A
STT2405	N	S	STC	211	TO 5	75	60	10.0	7.500A	10.000W	200J	25.000G	1UA	40V	52	2.000A
STT2406	N	S	STC	211	TO 5	40	30	10.0	7.500A	10.000W	200J	25.000G	500UA	20V	45	2.000A
STT2650	N	S	STC	561	TO 61	150	150	12.0	7.500A	75.000W	200J	25.000G	1UA	60V	52	2.000A
STT2651	N	S	STC	561	TO 61	140	120	12.0	7.500A	75.000W	200J	25.000G	1UA	60V	52	2.000A
STT2652	N	S	STC	561	TO 61	140	120	12.0	7.500A	75.000W	200J	25.000G	1UA	60V	88	2.000A
STT2653	N	S	STC	561	TO 61	120	100	12.0	7.500A	75.000W	200J	25.000G	1UA	60V	52	2.000A
STT2654	N	S	STC	561	TO 61	100	80	12.0	7.500A	75.000W	200J	25.000G	1UA	60V	52	2.000A
STT2655	N	S	STC	561	TO 61	75	60	10.0	7.500A	75.000W	200J	25.000G	1UA	40V	52	2.000A
STT2656	N	S	STC	561	TO 61	40	30	10.0	7.500A	75.000W	200J	25.000G	500UA	20V	45	2.000A
STT2800	N	S	STC	561	TO 59	150	150	12.0	7.500A	40.000W	200J	25.000G	1UA	60V	52	2.000A
STT2801	N	S	STC	561	TO 59	140	120	12.0	7.500A	40.000W	200J	25.000G	1UA	60V	52	2.000A
STT2802	N	S	STC	561	TO 59	140	120	12.0	7.500A	40.000W	200J	25.000G	1UA	60V	88	2.000A
STT2803	N	S	STC	561	TO 59	120	100	12.0	7.500A	40.000W	200J	25.000G	1UA	60V	52	2.000A
STT2804	N	S	STC	561	TO 59	100	80	12.0	7.500A	40.000W	200J	25.000G	1UA	60V	52	2.000A
STT2805	N	S	STC	561	TO 59	75	60	10.0	7.500A	40.000W	200J	25.000G	1UA	40V	52	2.000A
STT2806	N	S	STC	561	TO 59	40	30	10.0	7.500A	40.000W	200J	25.000G	500UA	20V	45	2.000A
SVL792	P	G	ETC	210	TO 5	20		10.0		-150W	100A	4.800G	6UA	5V	75	
SVL4443	N	S	SVL	211	TO 5	70	45	5.0	2.000A	5.000W	200J	400.000G	200NA	60V	40	
T0003			SEE	2N207												
T0004			SEE	2N207A												
T0005			SEE	2N207B												
T0014			SEE	2N536												
T0015			SEE	2N535A												
T0033			SEE	2N535												
T1013			SEE	2N223												
T1028			SEE	2N128												
T1032			SEE	2N346												
T1038			SEE	2N240												
T1042			SEE	2N226												
T1046			SEE	2N224												
T1166			SEE	2N393												
T1224			SEE	2N344												
T1225			SEE	2N345												
T1250			SEE	2N588												
T1251			SEE	2N499												
T1275			SEE	2N495												
T1276			SEE	2N496												
T1289			SEE	2N300												
T1291			SEE	2N299												
T1312			SEE	2N501												
T1314			SEE	2N504												
T1322			SEE	2N503												
T1326			SEE	2N598												
T1327			SEE	2N1122												
T1328			SEE	2N1122A												
T1334			SEE	2N597												
T1342			SEE	2N502												
T1346			SEE	2N599												
T1347			SEE	2N670												
T1392			SEE	2N1126												
T1393			SEE	2N671												
T1395			SEE	2N600												
T1396			SEE	2N1124												
T1397			SEE	2N1125												
T1398			SEE	2N1127												
T1411			SEE	2N672												
T1472			SEE	2N1495												
T1473			SEE	2N1496												
T1474			SEE	2N1500												
T1475			SEE	2N673												
T1510			SEE	2N501A												
T1512			SEE	2N601												
T1537			SEE	2N1123												
T1546			SEE	2N1129												
T1573			SEE	2N1130												
T1574			SEE	2N1128												
T1808			SEE	2N1494												
T1930			SEE	2N768												
TA2658			SEE	2N3866												
TA2714			SEE	2N4032												
TA2761			SEE	40609												
TA2791			SEE	2N5102												
TF78/30	P	G	SIH	170	TO 8	32	24	10.0	.600A	3.000W	90J	.700F	30UA	32V	68	.050A
TF78/60	P	G	SIH	170	TO 8	64	45	16.0	.600A	3.000W	90J	.700F	30UA	64V	68	.050A
Ti-156	P	G	TII	211	211G	30	30	15.0	3.000A	25.000W	100J	.220G	650UA	30V	60	60
Ti-156L	P	G	TII	211	211F	30	30	15.0	3.000A	25.000W	100J	.220G				

Transistor Type No.	N P	G S	Manufacturer	Lead Ident	Out- line	Maximum (V)			Maximum		Max. T.(°C)	Frequency Resp.(MHz)	Leakage I _{BO} @ V _{CE}	Gain h _{FE} @ I _C		
						V _{CE}	V _{ES}	V _{ES}	I _C	Power						
Tl-159	P	G	TII	211	211H	40	30	20.0	3.000A	20.000W	100C	225.000G	125UA	20V	50	
Tl-160	P	G	TII	211	211H	80	50	20.0	3.000A	20.000W	100C	225.000G	125UA	40V	50	
Tl-161	P	G	TII	211	211H	80	50	20.0	3.000A	20.000W	100C	225.000G	125UA	40V	50	
Tl-162	P	G	TII	211	211H	100	60	20.0	3.000A	20.000W	100C	225.000G	125UA	50V	50	
Tl-363	P	G	TII	120	58	30			.050A	.150W	85I	AM IF	335UA	12V	40	
Tl-364	P	G	TII	120	58	30			.050A	.150W		AM IF	335UA	12V	40	
Tl-365	P	G	TII	120	58	30			.050A	.150W		70.000G	335UA	12V	140	
Tl-368	P	G	TII	120	58	30			.050A	.150W		80.000G	335UA	12V	70	
Tl-389	P	G	TII	120	58	30			.050A	.150W		100.000G	335UA	12V	40	
Tl-390	P	G	TII	217	72	18			.050A	.075W		990.000B	5UA	10V	80	
Tl-391	P	G	TII	217	72	18			.050A	.075W		990.000B	5UA	10V	40	
Tl-392	P	G	TII	217	72	18			.050A	.075W		990.000B	5UA	10V	40	
Tl-393	P	G	TII	217	72	18			.050A	.075W		990.000B	5UA	10V	50	
Tl-395	P	G	TII	120	58	30			.050A	.150W		100.000G	335UA	12V	120	
Tl-396	P	G	TII	120	58	45			.050A	.150W		60.000G	335UA	12V	120	
Tl-397	P	G	TII	120	58	35			.050A	.150W		45.000G	335UA	12V	70	
Tl-398	P	G	TII	120	58	35			.050A	.150W		45.000G	335UA	12V	60	
Tl-399	P	G	TII	120	58	35			.050A	.150W		AM IF	31A	12V	40	
Tl-400	P	G	TII	250	250A	18		.3	.050A	.075W	100J	400.000G	5UA	10V	80	
Tl-401	P	G	TII	250	250A	18		.3	.050A	.075W	100J	300.000G	5UA	10V	80	
Tl-402	P	G	TII	250	250A	18		.3	.050A	.075W	100J	300.000G	5UA	10V	40	
Tl-403	P	G	TII	250	250A	18		.3	.050A	.075W	100J	300.000G	5UA	10V	70	
Tl-407	N	S	TII	43	92	25	12	3.0	.030A	.200W	125A	450.000G	500NA	10V	20	
Tl-408	N	S	TII	43	92	25	12	3.0	.030A	.200W	125A	300.000G	500NA	10V	16	
Tl-409	N	S	TII	43	92	25	12	3.0	.030A	.200W	125A	300.000G	500NA	10V	16	
Tl-411	N	S	TII	43	92	50	30	5.0	.800A	.300W	125A	100.000G	500NA	20V	420	
Tl-412			SEE 2N3704													
Tl-413			SEE 2N3705													
Tl-414			SEE 2N3706													
Tl-415			SEE 2N3707													
Tl-416			SEE 2N3708													
Tl-417			SEE 2N3710													
Tl-418			SEE 2N3711													
Tl-419	N	S	TII	43	92	30	30	6.0	.030A	.250W	125A	AM IF	500NA	20V	370	
Tl-420			SEE 2N2387													
Tl-421			SEE 2N2388													
Tl-422			SEE 2N851													
Tl-423			SEE 2N852													
Tl-424			SEE 2N2389													
Tl-425			SEE 2N2390													
Tl-428			SEE 2N2393													
Tl-429			SEE 2N2394													
Tl-430			SEE 2N849													
Tl-431			SEE 2N850													
Tl-432			SEE 2N2395													
Tl-433			SEE 2N2396													
Tl-474			SEE 2N929													
Tl-475			SEE 2N930													
Tl-480	N	S	TII	210	10	11	50	40	1.0	.060A	.600W	125I	1.000B	2UA	30V	22
Tl-481	N	S	TII	210	10	11	80	70	1.0	.060A	.600W	125I	1.000B	2UA	30V	22
Tl-482	N	S	TII	211	10	5	20	20	5.0	.500A	.600W	150J	30.000B	2UA	10V	40
Tl-483	N	S	TII	211	10	5	40	20	5.0	.500A	.600W	150J	40.000G	2UA	30V	40
Tl-484	N	S	TII	211	10	5	40	20	5.0	.500A	.600W	150J	40.000G	2UA	30V	80
Tl-485	N	S	TII	211	10	18	20	14	3.0	1.000A	.300W	150J	100.000G	1UA	15V	36
Tl-486	N	S	TII	211	10	5	80	60	6.0	.750A	.800W	175J	10.000G	3UA	60V	40
Tl-487	N	S	TII	541	5410	80	60	6.0	.750A	15.000W	175J	10.000G	3UA	60V	40	
Tl-490	N	S	TII	210	10	5	40	20	1.0	.025A	.125W	125I	4.000B	2UA	30V	36
Tl-492	N	S	TII	210	10	5	40	20	1.0	.020A	.125W	125I	10.000B	2UA	20V	30
Tl-493	N	S	TII	210	10	5	40	20	1.0	.020A	.125W	125I	10.000B	2UA	20V	80
Tl-494	N	S	TII	210	10	5	40	20	1.0	.020A	.125W	125I	10.000B	2UA	20V	180
Tl-495	N	S	TII	210	10	5	40	20	1.0	.020A	.125W	125I	10.000B	2UA	20V	20
Tl-496	N	S	TII	210	10	11	70			.060A	.600W	125I	2.50G	1MA	80V	50
Tl-536	P	G	TII	561	561G	80	60	28.0	3.500A	25.000W	100C	2.50G	1MA	80V	80	
Tl-540	P	G	TII	561	561G	80	60	28.0	3.500A	25.000W	100C	2.50G	1MA	80V	80	
Tl-891			SEE 2N2861													
Tl-891			SEE 2N2862													
Tl-1121	N	S	TII	731	53	53	200	100	8.0	7.500A	80.000W	175J	7.500G	100UA	30V	74
Tl-1122	N	S	TII	731	53	53	200	100	8.0	7.500A	80.000W	175J	7.500G	100UA	30V	38
Tl-1123	N	S	TII	731	53	150	75	8.0	7.500A	80.000W	175J	7.500G	100UA	30V	38	
Tl-1124	N	S	TII	731	53	150	75	8.0	7.500A	80.000W	175J	7.500G	100UA	30V	38	
Tl-1125	N	S	TII	731	53	100	50	8.0	7.500A	80.000W	175J	7.500G	100UA	30V	74	
Tl-1126	N	S	TII	731	53	100	50	8.0	7.500A	80.000W	175J	7.500G	100UA	30V	38	
Tl-1131	N	S	TII	561	61	200	100	8.0	7.500A	80.000W	175J	7.500G	100UA	30V	74	
Tl-1132	N	S	TII	561	61	200	100	8.0	7.500A	80.000W	175J	7.500G	100UA	30V	38	
Tl-1133	N	S	TII	561	61	150	75	8.0	7.500A	80.000W	175J	7.500G	100UA	30V	74	
Tl-1134	N	S	TII	561	61	150	75	8.0	7.500A	80.000W	175J	7.500G	100UA	30V	38	
Tl-1135	N	S	TII	561	61	100	50	8.0	7.500A	80.000W	175J	7.500G	100UA	30V	74	
Tl-1136	N	S	TII	561	61	100	50	8.0	7.500A	80.000W	175J	7.500G	100UA	30V	38	
Tl-1141	N	S	TII	731	53	200	100	8.0	7.500A	80.000W	175J	7.500G	100UA	30V	50	
Tl-1142	N	S	TII	731	53	200	100	8.0	7.500A	80.000W	175J	7.500G	100UA	30V	26	
Tl-1143	N	S	TII	731	53	150	75	8.0	7.500A	80.000W	175J	7.500G	100UA	30V	50	
Tl-1144	N	S	TII	731	53	150	75	8.0	7.500A	80.000W	175J	7.500G	100UA	30V	26	
Tl-1145	N	S	TII	731	53	100	50	8.0	7.500A	80.000W	175J	7.500G	100UA	30V	50	
Tl-1146	N	S	TII	731	53	100	50	8.0	7.500A	80.000W	175J	7.500G	100UA	30V	26	
Tl-1151	N	S	TII	561	61	200	100	8.0	7.500A	80.000W	175J	7.500G	100UA	30V	50	
Tl-1152	N	S	TII	561	61	200	100	8.0	7.500A	80.000W	175J	7.500G	100UA	30V	26	
Tl-1153	N	S	TII	561	61	150	75	8.0	7.500A	80.000W	175J	7.500G	100UA	30V	50	
Tl-1154	N	S	TII	561	61	150	75	8.0	7.500A	80.000W	175J	7.500G	100UA	30V	26	
Tl-1155	N	S	TII	561	61	100	50	8.0	7.500A	80.000W	175J	7.500G	100UA	30V	50	
Tl-1156	N	S	TII	561	61	100	50	8.0	7.500A	80.000W	175J	7.500G	100UA	30V	26	
Tl-3015			SEE 2N3570													
Tl-3027	P	G	TII	605	3	45	40R	20.0	7.000A	150.000W	100J	2.00G	1MA	30V	102	3.000A
Tl-3028	P	G	TII	605	3	60	50R	20.0	7.000A	150.000W	100J	2.00G	1MA	30V	102	3.000A
Tl-3029	P	G	TII	605	3	80	55R	20.0	7.000A	150.000W	100J	2.00G	1MA	50V	102	3.000A
Tl-3030	P	G	TII	605	3	100	66R	20.0	7.000A	150.000W	100J	2.00G	1MA	60V	102	3.000A
Tl-3031	P	G	TII	605	3	120	65R	20.0	7.000A	150.000W	100J	2.00G	1MA	70V	102	3.000A
IA01	P	G	TII	211	39	150	75	8.0	.150A	.150W	100A	4.000B	5UA	25V		
IA02	P	G	TII	211	39	40	25R	30.0	.150A	.150W	100A	4.000B	5UA	20V		
IA03	P	G	TII	211	39	25	20R	25.0	.150A	.150W	100A	4.000B	5UA	20V		
IA04	P	G	TII	211	39	25	20R	25.0	.150A	.150W	100A	4.000B	5UA	20V		

Transistor Type No.	N P	G S	Manufacturer	Lead Ident	Out line	Maximum (V)			Maximum Power		Max. T.(°C)	Frequency Resp (MHz)	Leakage		Gain	
						V _{CE}	V _{BE}	V _{ES}	I _C	Power			I _{CE} @ V _{CE}	V _{CE} @ I _{CE}	f _T @ I _C	
TIP24	N	S	TI	760	760A	70	70R	9.0	2.000A	10.000W	150J	10.000G	250UA	70V	54	1.500A
TIP27	N	S	TI	760	760A	300	300	6.0	5.00A	10.000W	150C	2.000G			63	.200A
TIP29	N	S	TI	54	54B	40	40	5.0	1.000A	30.000W	150J	3.000G	200UA	40V	90	.200A
TIP29A	N	S	TI	54	54B	60	60	5.0	1.000A	30.000W	150J	3.000G	200UA	60V	90	.200A
TIP30	N	S	TI	54	54B	40	40	5.0	1.000A	30.000W	150J	3.000G	200UA	40V	90	.200A
TIP30A	N	S	TI	54	54B	60	60	5.0	1.000A	30.000W	150J	3.000G	200UA	60V	90	.200A
TIP31	N	S	TI	54	54B	40	40	5.0	3.000A	40.000W	150J	3.000G	300UA	40V	45	1.000A
TIP31A	N	S	TI	54	54B	60	60	5.0	3.000A	40.000W	150J	3.000G	300UA	60V	45	1.000A
TIP32	N	S	TI	54	54B	40	40	5.0	3.000A	40.000W	150J	3.000G	300UA	40V	45	1.000A
TIP32A	N	S	TI	54	54B	60	60	5.0	3.000A	40.000W	150J	3.000G	300UA	60V	45	1.000A
TIP33	N	S	TI	54	54C	40	40	5.0	10.000A	80.000W	150J	3.000G	400UA	40V	56	1.000A
TIP33A	N	S	TI	54	54C	60	60	5.0	10.000A	80.000W	150J	3.000G	400UA	60V	56	1.000A
TIP34	N	S	TI	54	54C	40	40	5.0	10.000A	80.000W	150J	3.000G	400UA	40V	56	1.000A
TIP34A	N	S	TI	54	54C	60	60	5.0	10.000A	80.000W	150J	3.000G	400UA	60V	56	1.000A
TIP35	N	S	TI	54	54C	40	40	5.0	25.000A	90.000W	150J	3.000G	700UA	40V	45	5.000A
TIP35A	N	S	TI	54	54C	60	60	5.0	25.000A	90.000W	150J	3.000G	700UA	60V	45	5.000A
TIP36	N	S	TI	54	54C	40	40	5.0	25.000A	90.000W	150J	3.000G	700UA	40V	45	5.000A
TIP36A	N	S	TI	54	54C	60	60	5.0	25.000A	90.000W	150J	3.000G	700UA	60V	45	5.000A
TIS03			SEE 2N3702													
TIS04			SEE 2N3703													
TIS18	N	S	TI	930	930A	45	45	6.0	.050A	.150W	125A	30.000G	10NA	45V	70	
TIS22	N	S	TI	930	930A	45	45	6.0	.050A	.150W	125A	30.000G	10NA	45V	180	
TIS23	N	S	TI	930	930A	45	45	6.0	.050A	.150W	125A	30.000G	10NA	45V	220	
TIS24	N	S	TI	930	930A	60	60	6.0	.050A	.150W	125A	60.000G	10NA	45V	220	
TIS37	N	S	TI	43	TO 92	35	32	6.0	.050A	.200W	125A	80.000G	100NA	10V	90	.001A
TIS38	N	S	TI	43	TO 92	25	20R	3.0	.050A	.250W	125A	200.000G	500NA	15V	40	.010A
TIS44	N	S	TI	43	TO 92	40	15	4.5	.200A	.250W	125A	400.000G	50NA	20V	60	.010A
TIS45	N	S	TI	43	TO 92	40	15	4.5	.200A	.250W	125A	400.000G	50NA	20V	60	.010A
TIS46	N	S	TI	43	TO 92	40	15	4.5	.200A	.250W	125A	400.000G	50NA	20V	60	.010A
TIS47	N	S	TI	43	TO 92	40	15	4.5	.200A	.250W	125A	400.000G	50NA	20V	60	.010A
TIS48	N	S	TI	43	TO 92	40	15	4.5	.200A	.250W	125A	400.000G	50NA	20V	60	.010A
TIS49	N	S	TI	43	TO 92	40	15	4.5	.200A	.250W	125A	400.000G	50NA	20V	60	.010A
TIS50	N	S	TI	43	TO 92	12	12	4.0	.200A	.250W	125A	400.000G	10A	6V	80	.030A
TIS51	N	S	TI	43	TO 92	30	12	5.0	.200A	.250W	125A	400.000G	500NA	20V	60	.030A
TIS52	N	S	TI	43	TO 92	25	15	5.0	.050A	.200W	125A	350.000G	500NA	20V	60	.030A
TIS53	N	S	TI	43	TO 92	6	6	4.0	.080A	.250W	125A	500.000G	10NA	3V	60	.010A
TIS54	N	S	TI	43	TO 92	12	12	4.0	.080A	.250W	125A	300.000G	10NA	6V	60	.010A
TIS55	N	S	TI	43	TO 92	40	15	5.0	.200A	.250W	125A	350.000G	500NA	20V	60	.030A
TIS56	N	S	TI	217	TO 72	30	20	3.0	.030A	.200W	175A	500.000G	50NA	10V	60	.004A
TIS57	N	S	TI	217	TO 72	30	20	3.0	.030A	.200W	175A	500.000G	50NA	10V	40	.004A
TIS58	N	S	TI	168	168A	30	12	3.0	.030A	.200W	125J	500.000G	100NA	10V	60	.004A
TIS63	N	S	TI	168	168A	30	12	3.0	.030A	.200W	125J	500.000G	100NA	10V	40	.004A
TIS64	N	S	TI	168	168A	30	12	3.0	.030A	.200W	125J	500.000G	100NA	10V	40	.004A
TIS66	N	S	TI	907	907A	25	15	1.0	.050A	.500W	175J	2400.000G	10A	15V	30	.015A
TIS71	N	S	TI	211	TO 5	60	40	5.0	1.200A	1.000W	125J	250.000G	500NA	40V	50	1.000A
TIS72	N	S	TI	43	TO 92	40	25	4.0	.050A	.250W	150J	600.000G	100NA	15V	60	.005A
TIS82	N	S	TI	168	168A	40	30	4.0	.050A	.250W	150J	350.000G	50NA	10V	60	.004A
TIS83	N	S	TI	168	168A	40	30	4.0	.050A	.250W	150J	350.000G	50NA	10V	50	.004A
TIS84	N	S	TI	168	168A	40	30	4.0	.050A	.250W	150J	350.000G	50NA	10V	50	.004A
TIS85	N	S	TI	168	168A	30	30	4.0	.050A	.400W	150J	500.000G	100NA	15V	90	.004A
TIS86	N	S	TI	168	168A	45	45	4.0	.050A	.400W	150J	500.000G	100NA	15V	68	.012A
TIS87	N	S	TI	43	TO 92	60	40	6.0	.200A	.360W	150J	200.000G	10A	80V	200	.01A
TIS94	N	S	TI	43	TO 92	60	40	6.0	.200A	.360W	150J	200.000G	10A	80V	200	.01A
TIS95	N	S	TI	43	TO 92	60	65	6.0	.200A	.360W	150J	200.000G	10A	80V	110	100A
TIS96	N	S	TI	168	168A	60	40	6.0	.200A	.360W	150J	200.000G	10A	60V	340	.01A
TIS97	N	S	TI	168	168A	60	60	6.0	.200A	.360W	150J	200.000G	10A	80V	260	.01A
TIS98	N	S	TI	168	168A	80	65	6.0	.200A	.360W	150J	200.000G	10A	80V	110	100A
TIS99	N	S	TI	168	168A	80	65	6.0	.200A	.360W	150J	200.000G	10A	80V	110	100A
TIX210			SEE 2N3551													
TIX211			SEE 2N3552													
TIX316	P	G	TI	217	TO 72	15	10	.3	.050A	.075W	100J	400.000G	5UA	10V	70	
TIX317			SEE 2N3601													
TIX318			SEE 2N3603													
TIX319			SEE 2N3554													
TIX888	N	S	TI	909	TO 50	30	15	3.0	.050A	.200W	200C	990.000G	10NA	6V	110	
TIX3016A	N	S	TI	907	907A	30	15	3.0	.050A	.200W	100C	1000.000G	10NA	6V	80	.005A
TIX3024	P	G	TI	907	907A	15	7	.3	.050A	.075W	100A	990.000G	6UA	10V	150	
TIX3032	P	G	TI	217	TO 72	25	15	.2	1.00A	.075W	100C	500.000G	10UA	15V	120	
TIX3033			SEE 2N3418													
TIX3034			SEE 2N3419													
TIX3035			SEE 2N3420													
TIX3036			SEE 2N3421													
TIXM01	P	G	TI	170	170H	20	10	.2	.030A	.075W	100A	355.000G	10UA	10V	40	.001A
TIXM02	P	G	TI	170	170H	20	10	.2	.030A	.075W	100A	282.000G	10UA	10V	40	.001A
TIXM03	P	G	TI	170	170H	20	10	.2	.030A	.075W	100A	316.000G	10UA	10V	20	.001A
TIXM04	P	G	TI	170	170H	20	10	.2	.030A	.075W	100A	224.000G	10UA	10V	40	.002A
TIXM05	P	G	TI	170	170H	20	10	.2	.030A	.075W	100A	450.000G	10UA	10V	40	.002A
TIXM06	P	G	TI	170	170H	20	10	.2	.030A	.075W	100A	380.000G	10UA	10V	40	.002A
TIXM07	P	G	TI	170	170H	20	10	.2	.030A	.075W	100A	315.000G	10UA	10V	20	.002A
TIXM08	P	G	TI	170	170H	20	10	.2	.030A	.075W	100A	380.000G	10UA	10V	40	.002A
TIXM10	P	G	TI	170	170H	18	12	.2	.050A	.075W	100A	630.000G	10UA	10V	42	.003A
TIXM11	P	G	TI	170	170H	12	12	.3	.075A	.075W	125J	900.000G	10UA	10V	54	.003A
TIXM13	P	G	TI	168	168A	15	7	.3	.030A	.030W	125J	1000.000G	5UA	6V	80	.002A
TIXM14	P	G	TI	43	TO 92	20	16	.3	.050A	.070W	125J	120.000G	5UA	6V	90	.002A
TIXM15	P	G	TI	43	TO 92	20	16	.3	.050A	.070W	125J	300.000G	5UA	6V	40	.002A
TIXM16	P	G	TI	43	TO 92	20	16	.3	.050A	.070W	125J	110.000G	5UA	6V	40	.002A
TIXM17	P	G	TI	43	TO 92	20	16	.3	.050A	.070W	125J	300.000G	5UA	6V	70	.002A
TIXM18	P	G	TI	168	168A	18	12	.2	.050A	.070W	125J	900.000G	5UA	10V	90	.003A
TIXM19	P	G	TI	168	168A	18	12	.2	.050A	.070W	125J	900.000G	5UA	10V	100	.003A
TIXM101	P	G	TI	217	TO 72	15	7	.3	.050A	.075W	100A	1500.000G	6UA	9V	100	.002A
TIXM103	P	G	TI	91												

Transistor Type No.	N P S	Manufacturer	Lead Ident	Out- line	Maximum (V)			Maximum		Max. T _c (°C)	Frequency Resp.(MHz)	Leakage		Gain h _{FE} @ I _C
					V _{CE}	V _{ES}	V _{ES}	I _C	Power			I _{ES} @ V _{CE}	I _{CS} @ V _{ES}	
TIXS30	-N	TI	43	To 92	40	40	4.0	.030A	.200W	125A	500.000G	100NA 20V	60	.004A
TIXS31	-N	TI	43	To 92	40	40	4.0	.030A	.200W	125A	500.000G	100NA 20V	60	.004A
TIXS39	-N	TI	211	To 5	30	20	2.0	.200A	.720W	175C	600.000G	500NA 15V	80	.050A
TNS4	-N	SPR	210	To 18	75	45	5.0	.800A	.800W	200J	100.000G	10NA 60V	100	.150A
TNS4	-N	SPR	210	To 18	75	45	5.0	.800A	.500W	200J	100.000G	10NA 60V	100	.150A
TNS5	-N	SEE 2N4384												
TNS6	-N	SEE 2N4385												
TNS7	-N	SEE 2N4386												
TNS8	-N	SEE 2N4386												
TNS9	N	SPR	210	To 5	40	30	5.0	.800A	.800W	200J	100.000G	20NA 30V	200	.150A
TN60	N	SPR	210	To 18	40	30	5.0	.800A	.500W	200J	100.000G	20NA 30V	200	.150A
TN61	N	SPR	210	To 5	40	30	5.0	.800A	.800W	200J	100.000G	20NA 30V	200	.150A
TN62	N	SPR	210	To 18	40	30	5.0	.800A	.500W	200J	100.000G	20NA 30V	100	.150A
TN63	N	SPR	210	To 5	20	20	5.0	.800A	.800W	200J	100.000G	100NA 20V	50	.150A
TN64	N	SPR	210	To 18	20	20	5.0	.800A	.500W	200J	100.000G	100NA 20V	50	.150A
TN79	N	SPR	210	To 5	30	25	5.0	.800A	.800W	200J	50.000G	1NA 5V	200	.010A
TN80	N	SPR	210	To 18	30	20	5.0	.500A	.500W	200J	50.000G	1NA 5V	200	.010A
TN81	N	SPR	210	To 5	30	20	5.0	.800A	.800W	200J	200.000G	100NA 30V	50	.150A
TN237	-N	SPR	210	To 5	35	30	5.0	.800A	.800W	200C	100.000G	1NA 30V	100	.150A
TN224	-N	SP	211	To 211B	100	60	5.0	3.000A	.850W	200J	40.000G	100NA 60V	90	
TN624-1	N	SSP	211	To 5	100	60	5.0	3.000A	.850W	200J	40.000G	100NA 60V	90	
TN624-2	N	SSP	581	581B	100	60	5.0	3.000A	5.000W	200J	40.000G	100NA 60V	90	
TN624-3	N	SSP	546	546A	100	60	5.0	3.000A	5.000W	200J	40.000G	100NA 60V	90	
TP3638	P	SPR	168	168B	25	25			.360W		100.000G		45	.050A
TP3638A	P	SPR	168	168B	25	25			.360W		150.000G		150	.050A
TP4274	N	SPR	168	168B	12	12			.280W		400.000G		75	.010A
TP4275	N	SPR	168	168B	15	15			.280W		400.000G		75	.010A
TQ53	-P	SPR	210	To 5	75	45	5.0	.600A	.600W	200J	100.000G	10NA 60V	100	.150A
TQ53A	-P	SPR	210	To 5	80	75	5.0	.600A	.600W	200J	100.000G	10NA 60V	100	.150A
TQ54	-P	SPR	210	To 18	75	45	5.0	.600A	.400W	200J	100.000G	10NA 60V	100	.150A
TQ54	-P	SPR	210	To 18	80	75	5.0	.600A	.400W	200J	100.000G	10NA 60V	100	.150A
TQ55	-P	SEE 2N4412												
TQ56	-P	SEE 2N4413												
TQ57	-P	SEE 2N4414												
TQ58	-P	SEE 2N4415												
TQ59	P	SPR	210	To 5	40	30	5.0	.600A	.600W	200J	100.000G	20NA 30V	200	.150A
TQ59A	P	SPR	210	To 5	60	60	5.0	.600A	.600W	200J	100.000G	10NA 30V	200	.150A
TQ60	P	SPR	210	To 18	40	30	5.0	.600A	.400W	200J	100.000G	20NA 30V	200	.150A
TQ60A	P	SPR	210	To 18	60	60	5.0	.600A	.400W	200J	100.000G	10NA 60V	200	.150A
TQ61	P	SPR	210	To 5	40	30	5.0	.600A	.600W	200J	100.000G	20NA 30V	100	.150A
TQ61A	P	SPR	210	To 5	60	60	5.0	.600A	.600W	200J	100.000G	20NA 30V	100	.150A
TQ62	P	SPR	210	To 18	40	30	5.0	.600A	.400W	200J	100.000G	20NA 30V	100	.150A
TQ62A	P	SPR	210	To 18	60	60	5.0	.600A	.400W	200J	100.000G	20NA 30V	100	.150A
TQ63	P	SPR	210	To 5	20	20	5.0	.600A	.600W	200J	100.000G	100NA 20V	50	.150A
TQ63A	P	SPR	210	To 5	30	30	5.0	.600A	.600W	200J	100.000G	100NA 20V	50	.150A
TQ64	P	SPR	210	To 18	20	20	5.0	.600A	.600W	200J	100.000G	100NA 20V	50	.150A
TQ64A	P	SPR	210	To 18	30	30	5.0	.600A	.400W	200J	100.000G	100NA 20V	50	.150A
TR-01	P	G INR	605	To 3	70	50		7.000A	85.000W	110J	.600G		70	
TR-02	P	G INR	605	To 3	30	20		7.000A	85.000W	110J	.600G		100	
TR-03	P	G INR	405	To 36	50	40		15.000A	150.000W	110J	.600G		75	
TR-05	P	G INR	210	To 5	40	25		.200A	.200W	100J	4.000G		40	
TR-06	P	G INR	210	To 5	30	20		.200A	.200W	100J	4.000G		40	
TR-08	N	G INR	210	To 5	47	26		.300A	.150W	85J	25.000G		70	
TR-09	N	G INR	210	To 5	47	26		.300A	.150W	85J	25.000G		70	
TR-10	N	G INR	210	To 5	47	26		.300A	.150W	85J	25.000G		70	
TR-11	P	G INR	120	To 1	35	18		.025A	.060W	75J	7.000B		80	
TR-12	P	G INR	120	To 1	35	18		.010A	.055W	85J	4.000B		80	
TR-14	P	G INR	120	To 1	60	30		.150A	.150W	75J	1.000B		140	
TR-16	P	G INR	605	To 3	450	32		3.000A	70.000W	110J	.300B		80	
TR-17	P	G INR	217	To 72	25	29		.050A	.100W	100J	300.000G		60	
TR-19	P	S INR	210	To 5	25	25		.600A	.600W	200J	400.000G		60	
TR-20	P	S INR	210	To 18	25	25		.600A	.400W	200J	400.000G		60	
TR-21	N	S INR	210	To 18	25	25		.800A	.500W	175J	400.000G		60	
TR-22	N	S INR	210	To 18	25	25		.800A	.500W	175J	400.000G		60	
TR-23	N	S INR	605	To 68	375	350		3.000A	20.000W	175J	20.000G		60	
TR-24	N	S INR	41	To 92	40	25		.100A	.310W	135J	250.000G		50	
TR-25	N	S INR	210	To 5	65	50		.500A	5.000W	200J	100.000G		70	
TR-26	N	S INR	605	To 3	70	50		10.000A	90.000W	200J	7.000G		40	
TR-27	N	S INR	605	To 3	350	320		10.000A	56.000W	110J	1.000G		40	
TR-28	N	S INR	210	To 5	65	50		.500A	5.000W	200J	100.000G		70	
TR-29	P	S INR	605	To 3	70	50		10.000A	90.000W	200J	7.000G		40	
TR-30	P	S INR	41	To 92	40	25		.100A	.310W	135J	250.000G		75	
TRS301	-N	ITC	210	To 5	300	300	6.0		.600W	175J	50.000G	2UA 200V	60	
TRS350	-N	ITC	210	To 5	350	350	6.0		.600W	175J	50.000G	2UA 250V	60	
TRS401	-N	ITC	210	To 5	400	400	6.0		.600W	175J	50.000G	2UA 300V	60	
TRS450	-N	ITC	210	To 5	450	450	6.0		.600W	175J	50.000G	2UA 350V	60	
TRS501	-N	ITC	210	To 5	500	500	6.0		.600W	175J	50.000G	2UA 350V	60	
TRS550	-N	ITC	210	To 5	550	550	6.0		.600W	175J	50.000G	10UA 450V	60	
TRS601	-N	ITC	210	To 5	600	600	6.0		.600W	175J	50.000G	10UA 500V	60	
TRS701	-N	ITC	210	To 5	700	700	6.0		.600W	175J	50.000G	10UA 550V	50	
TRS750	-N	ITC	210	To 5	750	750	6.0		.600W	175J	40.000G	10UA 575V	50	
TRS801	-N	ITC	210	To 5	800	800	6.0		.600W	175J	40.000G	10UA 600V	50	
TRS3011	-N	ITC	210	To 46	300	300	6.0		.300W	175J	50.000G	2UA 200V	60	
TRS3012	-N	ITC	210	To 18	300	300	6.0		.300W	175J	50.000G	2UA 200V	60	
TRS3014	-N	ITC	210	To 5	300	300	6.0		.600W	1.000W	50.000G	2UA 200V	60	
TRS3015	-N	ITC	635	635B	300	300	6.0		15.000W	175J	50.000G	2UA 200V	60	
TRS3501	-N	ITC	210	To 46	350	350	6.0		.300W	175J	50.000G	2UA 250V	60	
TRS3502	-N	ITC	210	To 18	350	350	6.0		.300W	175J	50.000G	2UA 250V	60	
TRS3504	-N	ITC	210	To 5	400	400	6.0		.600W	1.000W	50.000G	2UA 250V	60	
TRS3505	-N	ITC	635	635B	350	350	6.0		15.000W	175J	50.000G	2UA 250V	60	
TRS4001	-N	ITC	210	To 46	400	400	6.0		.300W	175J	50.000G	2UA 300V	60	
TRS4002	-N	ITC	210	To 18	400	400	6.0		.300W	175J	50.000G	2UA 300V	60	
TRS4004	-N	ITC	210	To 5	400	400	6.0		1.000W	175J	50.000G	2UA 300V	60	
TRS4005	-N	ITC	635	635B	400	400	6.0		15.000W	175J	50.000G	2UA 300V	60	
TRS4501	-N	ITC	210	To 46	450	450	6.0		.300W	175J	50.000G	2UA 350V	60	
TRS4502	-N	ITC	210	To 18	450	450	6.0		.300W	175J	50.000G	2UA 350V	60	
TRS4504	-N	ITC	210	To 5	450	450	6.0		1.000W	175J	50.000G	2UA 350V	60	
TRS4505	-N	ITC	635	635B	450	450	6.0		15.000W	175J	50.000G	2UA 350V	60	
TRS5011	-N	ITC	210	To 46	500	500	6.0		.300W	175J	50.000G	2UA 350V	60	
TRS5012	-N	ITC	210	To 18	500	500	6.0		.300W	175J	50.000G	2UA 350V		

Transistor Type No.	N P S	G /	S	Manufacturer	Lead Ident	Out- line	Maximum (V)			Maximum		Max. T.(°C)	Frequency Resp.(MHz)	Leakage I _{sat} @ V _{ce}	Gain h _{FE} @ I _c		
							V _{ce}	V _{ce(sat)}	V _{ce(sat)}	I _c	Power						
TR57504	-N	S	ITC		210	TO 5	750	750S	6.0		1.000W	175J	40.000G	10UA	575V	59	
TR57505	-N	S	ITC		635	635B	750	750R	6.0		15.000W	175J	40.000G	10UA	575V	59	
TR58015	-N	S	ITC		210	TO 5	800	800S	6.0		1.000W	175J	40.000E	10UA	600V	50	
TS173	-P	G	ITSE		605	TO 3	30			2.000A	16.000W	85J	.006E	1MA	25V	50	
TS601	-P	G	ITSE		212	TO 5	12	9S	5.0	.400A	.200W	102J	AUD	20UA	9V	30	
TS602	-P	G	ITSE		212	TO 5	12	9S	5.0	.400A	.200W	100J	AUD	20UA	9V	30	
TS603	-P	G	ITSE		212	TO 5	20	18S	5.0	.400A	.200W	100J	AUD	20UA	9V	30	
TS604	-P	G	ITSE		212	TO 5	20	18	5.0	.400A	.200W	100J	AUD	20UA	9V	30	
TS612	-P	G	ITSE		605	TO 3	40	20		2.000A	16.000W	85J	.007E	300UA	25V	30	
TS613	-P	G	ITSE		605	TO 3	80	40		2.000A	16.000W	85J	.007E	300UA	25V	30	
TS616	-P	G	ITSE		10	10F	45			.050A	.170W	85J	1.000B	15UA	45V	28	
TS617	-P	G	ITSE		170	170E	25			.200A	.300W	85J	144.000-	20UA	20V	30	
TS618	-P	G	ITSE		170	170E	25			.200A	.300W	85J	144.000-	20UA	20V	30	
TS619	-P	G	ITSE		10	10F	25			.050A	.170W	85J	1.000B	15UA	25V	55	
TS620	-P	G	ITSE		10	10F	25			.050A	.170W	85J	1.000B	15UA	25V	55	
TS621	-P	G	ITSE		10	10F	25			.050A	.170W	85J	1.000B	15UA	25V	160	
TS630	-P	G	ITSE		10	10F	45			.050A	.170W	85J	1.000B	15UA	45V	60	
TV1000	-P	G	SEM		250	250A	15	15	2.0	.100A	.100W		1000.000G			140	
TW135	-P	S	SPR		210	TO 18	30		15.0	.100A	.400W	200J	10.000G	1NA	30V	165	
TZ81	-N	S	SPR		45	TO 98		30		.360W			30.000G			225	.001A
TZ82	-N	S	SPR		45	TO 98		30		.360W			30.000G			165	.001A
TZ551	-P	S	SPR		45	TO 98		30		.360W			150.000G			70	.150A
TZ552	-P	S	SPR		45	TO 98		30		.360W			150.000G			175	.150A
TZ553	-P	S	SPR		45	TO 98		30		.360W			150.000G			300	.150A
TZ554	-P	S	SPR		45	TO 98		30		.360W			150.000G			140	.150A
TZ581	-P	S	SPR		45	TO 98		30		.360W			20.000G			225	.001A
TZ582	-P	S	SPR		45	TO 98		30		.360W			20.000G			165	.001A
WX1180A	-N	S	WHE		412	TO 82	50	50	15.0	10.000A	100.000W	150J	.010E	1MA	50V	350	
WX1180B	-N	S	WHE		412	TO 82	100	100	15.0	10.000A	100.000W	150J	.010E	1MA	50V	350	
WX1180C	-N	S	WHE		412	TO 82	150	150	15.0	10.000A	100.000W	150J	.010E	1MA	50V	350	
WX1180A	-N	S	WHE		412	TO 82	50	50	15.0	10.000A	100.000W	150J	.017E	1MA	50V	650	
WX1180B	-N	S	WHE		412	TO 82	100	100	15.0	10.000A	100.000W	150J	.007E	1MA	50V	650	
WX1180C	-N	S	WHE		412	TO 82	150	150	15.0	10.000A	100.000W	150J	.007E	1MA	50V	680	
XA101	-P	G	AEI		31	31A	20	16	12.0	.120W	65J		5.000B			35	
XA102	-P	G	AEI		31	31A	20	16	12.0	.120W	65J		8.000B			60	
XA111	-P	G	AEI		169	169B	20	16	12.0	.120W	65J		5.000B			35	
XA112	-P	G	AEI		169	169B	20	16	12.0	.120W	65J		8.000B			60	
XA123	-P	G	AEI		75	TO 45	20		.5	.080W	85J		30.000B			60	
XA124	-P	G	AEI		75	TO 45	20		.5	.080W	85J		30.000B			60	
XA126	-P	G	AEI		75	TO 45	20		1.5	.080W	85J		30.000B			60	
XA131	-P	G	AEI		128	TO 44	30		.5	.125W	85J		100.000B			60	
XA141	-P	G	AEI		210	TO 5	30		2.0	.120W	71A		30.000G			45	
XA142	-P	G	AEI		210	TO 5	30		2.0	.120W	71A		30.000G			45	
XA143	-P	G	AEI		210	TO 5	30		2.0	.120W	71A		30.000G			45	
XB102	-P	G	AEI		31	31A	35	35R	12.0	.150W	75J		AUD			30	
XB103	-P	G	AEI		31	31B	35	35R	12.0	.150W	75J		AUD			66	
XB104	-P	G	AEI		31	31B	20	20R	12.0	.120W	65J		AUD			30	
XB112	-P	G	AEI		169	169B	35	35R	12.0	.150W	75J		AUD			30	
XB113	-P	G	AEI		169	169B	35	35R	12.0	.150W	75J		AUD			66	
XC101	-P	G	AEI		31	31B	35	35R	12.0	.165W	75J		AUD			66	
XC121	-P	G	AEI		169	169B	35	35R	12.0	.250W	75J		AUD			66	
XC131	-P	G	M.P.XC121		605	TO 3	40	40	12.0	3.000A	65.000W	90J	AUD			60	
XC141	-P	G	AEI		605	TO 3	60	40	12.0	3.000A	65.000W	90J	AUD			60	
XC142	-P	G	AEI		605	TO 3	80	50	60.0	10.000A	40.000W	90J	.650B			65	
XC155	-P	G	AEI		605	TO 3	80	50	60.0	10.000A	40.000W	90J	.650B			65	
XC156	-P	G	AEI		605	TO 3	100	65	60.0	10.000A	40.000W	90J	.650B			65	

R-F Power Transistors

Transistor Type No.	N	G	S	Manufacturer	Lead Ident.	Outline	Power	V_{CE}	ABSOLUTE MAXIMUMS V_{CE}	V_{CE}	Temp.	G_{cr}	R-F OPERATION Freq.	V_{ce}	η , (%)	Leakage I_{ce}	V_{ce}		
2N1505	N	S		TRW,HUG	211	To 5	3.0W	50V	20V	3.0V	175C	7.00B	1.0W	70MHZ	28V	36	50UA	28V	
2N1506	N	S		BEN,TRW,HUG	211	To 5	3.0W	60V	20V	4.0V	200C	9.00B	1.0W	70MHZ	28V	36	10UA	28V	
2N1506A	N	S		BEN,TRW,HUG	211	To 5	3.5W	80V	50V	5.0V	200J	10.00B	1.3W	70MHZ	28V	46	50MA	28V	
2N1709	N	S		TRW	171	To 8	13.0W	75V	30V	4.0V	175C	10.00B	5.0W	30MHZ	28V	50	10UA	28V	
2N1710	N	S		TRW	171	To 8	13.0W	60V	30V	3.0V	175C	8.00B	5.0W	30MHZ	28V	50	50UA	28V	
2N2095	N	S		HUG	171	To 31	1.0W	30V	15V	1.0V	100C	6.00B	.5W	160MHZ	15V				
2N2098	P	G	HUG	171	To 9		1.0W	30V	15V	1.0V	100C	6.00B	.5W	160MHZ	15V				
2N2631	N	S		RCA	211	To 39	8.8W	80V	60V	4.0V	200C	4.80B	3.0W	150MHZ	28V	70	100NA	30V	
2N2781	N	S		TRW	171	To 8	13.0W	75V	30V	5.0V	175C	12.50B	5.0W	30MHZ	28V	50	500UA	28V	
2N2782	N	S		TRW	171	To 8	13.0W	100V	40V	5.0V	175C	12.50B	5.0W	30MHZ	28V	50	500UA	28V	
2N2783	N	S		TRW	171	To 8	13.0W	100V	40V	5.0V	175C	12.50B	5.0W	30MHZ	28V	50	10UA	28V	
2N2874	N	S		TRW	171	To 8	15.0W	75V	40V	4.0V	175C	10.00B	3.0W	70MHZ	28V	40	100UA	30V	
2N2876	N	S		RCA	540	To 60	17.5W	80V	60V	4.0V	200C	4.80B	5.0W	150MHZ	28V	40	500UA	28V	
2N2887	N	S		RCA	540	To 60	25.0W	100V	80V	4.0V	200C	9.00B	10.0W	100MHZ	45V	50	500UA	28V	
2N3118	N	S		RCA,HUG	211	To 5	4.0W	85V	60V	4.0V	200C	10.00B	1.0W	50MHZ	28V	45	100NA	30V	
2N3229	N	S		RCA	540	To 60	11.6W	65V	40V	4.0V	200C	8.80B	15.0W	50MHZ	50V	70	100NA	30V	
2N3375	N	S		MOT,RCA,ITT,FSC,NSC,TII	540	To 60	11.6W	65V	40V	4.0V	200C	8.80B	15.0W	50MHZ	50V	70	1MA	65V	
2N3553	N	S		RCA,MOT,ITT,NSC,TII,AMP	211	To 39	7.0W	65V	40V	4.0V	200J	13.70B	7.5W	100MHZ	28V	70	1MA	65V	
2N3632	N	S		MOT,RCA,ITT,NSC,TII,AMP	540	To 60	23.0W	65V	40V	4.0V	200J	8.60B	13.5W	175MHZ	28V	70	500UA	65V	
2N3733	N	S		RCA,MOT,ITT,RAY,IMH	540	To 60	23.0W	65V	40V	4.0V	200C	4.00B	10.0W	400MHZ	28V	45	500UA	65V	
2N3866	N	S		RCA,MOT,ITT,NSC,TII,IMH	211	To 39	5.0W	55V	30V	3.5V	200C	10.00B	1.0W	400MHZ	28V	45	100UA	55V	
2N3924	N	S		MOT,AMP	571	To 8	15.0W	75V	40V	4.0V	200C	6.00B	4.0W	175MHZ	14V	70	100UA	15V	
2N3925	N	S		MOT	540	To 102	10.0W	36V	18V	4.0V	200C	5.40B	7.0W	175MHZ	14V	70	100UA	15V	
2N3926	N	S		MOT,AMP	543	To 60	11.6W	36V	18V	4.0V	200C	5.40B	7.0W	175MHZ	14V	70	100UA	15V	
2N3927	N	S		MOT,AMP	543	To 60	23.2W	36V	18V	4.0V	200C	4.80B	12.0W	175MHZ	14V	80	250UA	15V	
2N3948	N	S		MOT	210	To 39	5.0W	36V	20V	3.5V	200C	6.00B	1.0W	400MHZ	14V	45	100NA	15V	
2N3961	N	S		MOT	540	To 102	10.0W	65V	40V	4.0V	200C	9.00B	4.0W	175MHZ	28V	60	1MA	65V	
2N4012	N	S		MOT,RCA,ITT,IMH	540	To 60	11.6W	65V	40V	4.0V	200C	8.80B	2.5W	100MHZ	28V	25	1MA	65V	
2N4040	N	S		TRW,TII	962	To 117	17.5W	60V	40V	4.0V	200C	4.30B	8.0W	400MHZ	28V	40	200UA	30V	
2N4041	N	S		TRW,TII	962	To 117	10.0W	60V	40V	4.0V	200C	5.20B	3.3W	400MHZ	28V	50	200UA	30V	
2N4127	N	S		TRW	905	To 905B	12.0W	60V	40V	4.0V	200C	7.30B	13.5W	175MHZ	25V	60	500UA	30V	
2N4128	N	S		TRW	905	To 905B	10.0W	60V	40V	4.0V	200C	6.00B	24.0W	175MHZ	25V	65	500UA	30V	
2N4350	N	S		HUG	211	To 39	3.5W	40V	20V	2.0V	200C	10.00B	1.0W	400MHZ	28V	50	1MA	40V	
2N4427	N	S		RCA,ITT,AMP,MOT,IMH,HUG	211	To 39	4.5W	40V	20V	2.0V	200C	10.00B	1.0W	400MHZ	28V	35	1MA	55V	
2N4428	N	S		TRW,MOT	211	To 39	3.5W	55V	35V	3.5V	200J	10.00B	.8W	500MHZ	28V	35	1MA	55V	
2N4429	N	S		TRW	905	To 905C	5.0W	55V	35V	3.5V	200J	5.20B	1.0W	1000MHZ	28V	35	1MA	55V	
2N4430	N	S		TRW	905	To 905B	10.0W	55V	40V	3.5V	200J	5.00B	2.5W	1000MHZ	28V	35	2MA	55V	
2N4431	N	S		TRW	905	To 905B	10.0W	55V	40V	3.5V	200J	5.00B	2.5W	1000MHZ	28V	35	4MA	55V	
2N4440	N	S		RCA,RAY,IMH,SOL	540	To 60	11.6W	65V	40V	4.0V	200C	5.00B	5.8W	400MHZ	28V	45	10MA	60V	
2N4874	N	S		FSC	211	To 39	6.0W	30V	20V	2.0V	200C	10.00B	1.0W	400MHZ	20V			500NA	15V
2N4875	N	S		FSC	211	To 39	6.0W	40V	25V	2.0V	200C	9.50B	.9W	400MHZ	20V			500NA	15V
2N4876	N	S		FSC	211	To 39	6.0W	40V	25V	2.0V	200C	9.50B	.9W	400MHZ	20V			500NA	15V
2N4932	N	S		RCA	543	To 60	7.0W	60V	30V	4.0V	200C	5.40B	12.0W	70MHZ	14V	70	5MA	45V	
2N4933	N	S		RCA	543	To 60	7.0W	70V	35V	4.0V	200C	6.00B	20.0W	70MHZ	14V	70	10UA	18V	
2N5016	N	S		RCA,RAY	543	To 60	30.0W	65V	30V	4.0V	200C	4.80B	15.0W	400MHZ	28V	50	10MA	60V	
2N5025	N	S		FSC	543	To 60	45.0W	75V	75V	4.5V	200C	7.60B	20.0W	50MHZ	14V	65	10UA	60V	
2N5026	N	S		FSC	543	To 60	45.0W	90V	90V	4.5V	200J	10.00B	25.0W	80MHZ	28V	65	10UA	50V	
2N5070	N	S		RCA	543	To 60	7.0W	65V	30V	3.5V	200C	5.00B	3.0W	30MHZ	24V	60	10MA	60V	
2N5071	N	S		RCA	543	To 60	7.0W	65V	30V	4.0V	200C	9.00B	24.0W	70MHZ	24V	60	10MA	60V	
2N5090	N	S		RCA	543	To 60	50.0W	55V	30V	3.5V	200J	7.80B	1.2W	400MHZ	28V	45	1MA	55V	
2N5102	N	S		RCA	543	To 60	70.0W	90V	50V	4.0V	200C	4.00B	15.0W	136MHZ	24V	70	20MA	83V	
2N5108	N	S		RCA,RAY,MOT,SOL	211	To 39	3.5W	55V	35V	3.0V	200C	5.00B	1.0W	1000MHZ	28V	35	1MA	50V	
2N5108A	N	S		RCA,RAY,MOT,SOL	211	To 39	3.5W	55V	35V	3.0V	200C	5.00B	1.0W	1000MHZ	28V	35	10MA	50V	
2N5109	N	S		RCA	211	To 39	3.5W	40V	20V	3.0V	200C	11.00B	1.3W	200MHZ	15V	39	5MA	35V	
2N5160	N	S		MOT	211	To 39	5.0W	60V	40V	4.0V	200C	8.00B	1.0W	400MHZ	28V	45	1UA	28V	
2N5161	N	S		MOT	543	To 60	20.0W	66V	40V	4.0V	200C	8.80B	7.5W	175MHZ	28V	45	100UA	28V	
2N5162	P	P		MOT	543	To 60	50.0W	60V	40V	4.0V	200C	6.00B	30.0W	175MHZ	28V	55	100UA	28V	
2N5421	N	S		TRW	211	To 39	3.0W	36V	18V	4.0V	200C	8.00B	1.0W	175MHZ	14V	55	1UA	18V	
2N5422	N	S		TRW	211	To 39	5.0W	36V	18V	4.0V	200C	8.00B	2.0W	175MHZ	14V	70	1UA	18V	
2N5423	N	S		TRW	543	To 60	12.0W	36V	18V	4.0V	200C	6.00B	5.0W	175MHZ	14V	70	1UA	18V	
2N5424	N	S		TRW	543	To 60	20.0W	36V	18V	4.0V	200C	5.00B	4.1W	175MHZ	14V	70	1UA	18V	
2N5481	N	S		TRW	962	To 128	5.0W	50V	30V	3.0V	200C	6.00B	1.0W	2000MHZ	28V	25	2MA	50V	
2N5482	N	S		TRW	962	To 128	10.0W	50V	30V	3.0V	200C	5.00B	2.5W	2000MHZ	28V	30	3MA	50V	
2N5483	N	S		TRW	962	To 128	20.0W	45V	30V	3.0V	200C	6.00B	3.0W	2000MHZ	28V	30	6MA	40V	
2N5589	N	S		MOT	962	To 962A	15.0W	36V	18V	4.0V	200C	8.20B	3.0W	175MHZ	14V	50	1MA	15V	
2N5590	N	S		MOT	964	To 964C	30.0W	36V	18V	4.0V	200C	5.20B	10.0W	175MHZ	14V	50	1MA	15V	
2N5591	N	S		MOT	964	To 964C	70.0W	36V	18V	4.0V	200C	4.40B	25.0W	175MHZ	14V	50	1MA	15V	
2N5595	N	S		MOT	962	To 962B	20.0W	55V	30V	3.5V	200C	6.00B	10.0W	1000MHZ	28V	60	5MA	50V	
2N5596	N	S		MOT	962	To 962B	40.0W	55V	30V	3.5V	200C	5.00B	20.0W	1000MHZ	28V	60	5MA	50V	
2N5635	N	S		MOT	962	To 962A	7.5W	60V	35V	4.0V	200C	6.20B	2.5W	400MHZ	28V	50	100UA	30V	
2N5636	N	S		MOT	962	To 962A	15.0W	60V	35V	4.0V	200C	5.70B	7.5W	400MHZ	28V	50	1MA	30V	
2N5637	N	S		MOT	964	To 964C	30.0W	60V	35V	4.0V	200C	4.60B	20.0W	400MHZ	28V	60	1MA	30V	
2N5641	N	S		MOT	962	To 962A	15.0W	65V	35V	4.0V	200C	8.80B	1.0W	175MHZ	28V	60	1MA	30V	
2N5642	N	S		MOT	964	To 964C	30.0W	65V	35V	4.0V	200C	8.20B	20.0W	175MHZ	28V	60	1MA	30V	
2N5643	N	S		MOT	964	To 964C	60.0W	65V	35V	4.0V	200C	7.60B	40.0W	175MHZ	28V	60	1MA	30V	
2N5644	N	S		MOT	964	To 964B	3.5W	36V	18V	4.0V	200C	7.00B	1.0W	470MHZ	13V	60	100UA	15V	
2N5645	N	S		MOT	964	To 964B	12.0W	36V	18V	4.0V	200C	6.00B	4						

Transistor Type No.	M.P.S.	Manufacturer	Lead Ident.	Outline	ABSOLUTE MAXIMUMS				R-F OPERATION				Leakage			
					Power	V_{CE}	V_{CB}	Temp.	G_{out}	P_{out}	Freq.	V_{CE}	I_{CB}	V_{CB}		
40279	N S	RCA	540	TD 60	11.6W	65V	40V	4.0V	200J	8.8DB	7.5W	100MHZ	28V	65	100NA	30V
40280	N S	RCA	211	TD 39	7.0W	36V	18V	4.0V	200J	9.0DB	1.0W	175MHZ	14V	60	100UA	15V
40281	N S	RCA	543	TD 60	11.6W	36V	18V	4.0V	200J	6.0DB	4.0W	175MHZ	14V	70	100UA	15V
40282	N S	RCA	543	TD 60	23.2W	36V				4.8DB	12.0W			80	250UA	15V
40290	N S	RCA	211	TD 39	7.0W		50V X	4.0V	200J	6.0DB	2.0W	135MHZ	13V	70	100UA	15V
40291	N S	RCA	540	TD 60	11.6W		50V X	4.0V	200J	6.0DB	2.0W	135MHZ	13V	70	100UA	15V
40292	N S	RCA	540	TD 60	23.2W		50V X	4.0V	200J	4.8DB	6.0W			70	250UA	15V
40305	N S	RCA	211	TD 39	7.0W	65V	40V	4.0V	200J	10.0DB	2.5W	175MHZ	28V	50	100NA	30V
40306	N S	RCA	540	TD 60	11.6W	65V	40V	4.0V	200J	8.8DB	7.5W	100MHZ	28V	65	100NA	30V
40307	N S	RCA	540	TD 60	23.0W	65V	40V	4.0V	200J	5.8DB	13.5W	175MHZ	28V	70	250NA	30V
40340	N S	RCA	543	TD 60	70.0W	60V	25V	4.0V	200J	7.0DB	5.0W	25.0W		60	10MA	50V
40341	N S	RCA	543	TD 60	70.0W	70V	35V	4.0V	200J	10.0DB	30.0W	50MHZ	24V	60	10MA	40V
40446	N S	RCA	211	TD 39	10.0W		60V X	2.5V	200J	9.3DB	3.0W	27MHZ	12V			
40577	N S	RCA	211	TD 5	3.0W		85V X	4.0V	200J	10.0DB	1.0W	50MHZ	28V			
40578	N S	RCA	211	TD 39	5.0W	55V	30V	3.5V	200J	15.6DB	1.8W	100MHZ	28V	60	100NA	28V
40581	N S	RCA	635	635B	5.0W		60V X	2.5V	200J	10.0DB	3.5W	27MHZ	12V			
40582	N S	RCA	635	635B	10.0W		60V X	2.5V	200J	10.0DB	3.5W	27MHZ	12V			
40605	N S	RCA	211	TD 39	7.0W	65V	40V	4.0V	200J	8.8DB	13.5W	175MHZ	28V	50	100NA	30V
40665	N S	RCA	543	TD 60	23.0W	65V	40V	4.0V	200J	13.7DB	2.5W	175MHZ	28V	70	250UA	30V
40666	N S	RCA	543	TD 60	11.6W	65V	40V	4.0V	200J	13.7DB	7.5W	100MHZ	28V	65	100UA	30V
MM1549	N S	MDT	962	962A	7.5W	60V	35V	4.0V	200J	6.2DB	2.5W	400MHZ	28V	50	100UA	30V
MM1550	N S	MDT	962	962A	15.0W	60V	35V	4.0V	200J	5.7DB	7.5W	400MHZ	28V	50	1MA	30V
MM1551	N S	MDT	964	964C	30.0W	60V	35V	4.0V	200J	4.6DB	20.0W	400MHZ	28V	60	1MA	30V
MM1557	N S	MDT	962	962A	15.0W	65V	35V	4.0V	200J	8.4DB	7.0W	175MHZ	28V	60	1MA	30V
MM1558	N S	MDT	962	962A	30.0W	65V	35V	4.0V	200J	8.2DB	20.0W	175MHZ	28V	60	1MA	30V
MM1559	N S	MDT	964	964C	60.0W	65V	35V	4.0V	200J	7.6DB	40.0W	175MHZ	28V	60	1MA	30V
MM1603	N S	MDT	964	964C	70.0W	36V	18V	4.0V	200J	4.4DB	25.0W	175MHZ	14V	50	1MA	15V
MM4429	N S	MDT	964	964C	5.0W	55V	35V	3.5V	200J	5.2DB	1.0W	1000MHZ	28V			
MM4430	N S	MDT	964	964C	5.0W	55V	35V	3.5V	200J	5.0DB	2.5W	1000MHZ	28V			
MSA7505	N S	FSC	543	TD 60	25.0W		65V S	4.0V	200J	5.6DB	10.0W	400MHZ	28V	60	5MA	65V
MSA8505	N S	FSC	543	TD 60	21.0W		65V S	4.0V	200J	4.6DB	10.0W	400MHZ	28V	60	5MA	65V
MSA8506	N S	FSC	964	964B	50.0W		36V S	4.0V	200J	5.0DB	25.0W	175MHZ	14V	65		
SRF12212	N S	SOL	540	TD 60		40V	20V	4.0V		8.8DB	7.0W	175MHZ	13V			
SRF32214	N S	SOL	540	TD 60		40V	20V	4.0V		7.0DB	15.0W	175MHZ	13V			

Transistor Type No.	M.P.S.	Manufacturer	Lead Ident.	Outline	ABSOLUTE MAXIMUMS				R-F OPERATION				Leakage		
					Power	V_{CE}	V_{CB}	Temp.	G_{out}	P_{out}	Freq.	V_{CE}	I_{CB}	V_{CB}	
<p>- = Obsolete N = NPN G = Germanium S = Silicon</p> <p>Key to Manufacturers Page 192.</p> <p>M.P. - 2N224 = a matched pair of 2N224's. SEE 2N = Cross reference from an obsolete type to one with equal or higher specifications.</p> <p>Numbers refer to <u>Lead and Terminal Identification Page 182.</u></p> <p>TD numbers refer to <u>Registered Transistor Outlines Page 96.</u></p> <p>Other numbers refer to <u>Transistor Outlines Page 160.</u></p> <p>Maximum power that can be dissipated at 25° C case temperature.</p> <p>Maximum voltages that cannot be exceeded without permanent damage to the transistor.</p> <p>V_{CB} = Collector-to-base voltage with emitter open. V_{CE} = Collector-to-emitter voltage (base open, if no subscript indicated).</p> <p>R = Resistor between emitter and base. S = Short between emitter and base. X = B-E junction forward biased.</p> <p>V_{EB} = Emitter-to-base reverse voltage with collector open.</p>															
<p>Current between collector and base with emitter open, at voltage shown. MA = milliamperes. UA = microamperes. NA = nanoamperes.</p> <p>Collector efficiency (η_C) is for the conditions shown under RF operation.</p> <p>Operating characteristics at 25° case temperature. Design gain G_{out} produces output power P_{out} in a circuit operating at the indicated frequency (Freq) and using collector voltage supply V_{CC}.</p> <p>Maximum operating temperature (°C) A = ambient C = Case J = Junction</p>															

Registered Transistor Outlines

The outlines in this section have been registered and assigned a JEDEC outline number—a TO designation that indicates the semiconductor device has more than two terminals. (Two-terminal devices are assigned DO numbers.) The TO outline provides only the physical shape and dimensions of a semiconductor device. It does not indicate any electrical characteristics, such as base, emitter, collector. Terminal identification for transistors in this manual are to be found in the Lead and Terminal Identification section. For additional information relating to outline drawings, refer to Transistor Outlines, page 160.

The gaps in the numerical sequence of TO numbers are due to the fact that there are no outlines for TO-4, TO-19, TO-20, TO-21, TO-34, and TO-35.

The TO outline drawings and the related information in this section are reproduced through the courtesy of the Electronic Industries Association (EIA) and the Joint Electron Device Engineering Council (JEDEC).

TO 1

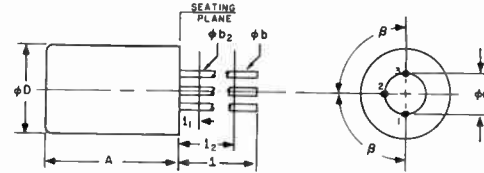

SYMBOL	INCHES		MILLIMETERS		NOTES
	MIN.	MAX.	MIN.	MAX.	
ϕa	.061	.081	1.55	2.06	
A		.410		10.41	
ϕb		.021		.533	1
ϕb_2	.016	.019	.406	.483	1
ϕD		.240		6.10	
l	1.500		38.10		1
l_1		.050		1.27	
l_2	.250		6.35		1
β	90° NOMINAL				

NOTES:

- (THREE LEADS) ϕb_2 APPLIES BETWEEN l_1 AND l_2 . ϕb APPLIES BETWEEN l_2 AND 1.5" (38.10 MM) FROM SEATING PLANE. DIAMETER IS UNCONTROLLED IN l_1 AND BEYOND 1.5" (38.10 MM) FROM SEATING PLANE.

THIS OUTLINE DOES NOT MEET THE MINIMUM CRITERIA ESTABLISHED BY JS-10 FOR REGISTRATION.

TO 2

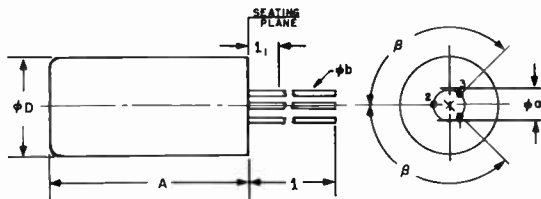

SYMBOL	INCHES		MILLIMETERS		NOTES
	MIN.	MAX.	MIN.	MAX.	
ϕa	.028	.035	.711	.889	
A		.255		6.48	
ϕb	.012	.014	.305	.356	2
ϕD		.135		3.43	
l	1.500		38.10		2
l_1		.080		2.03	1, 2
β	120° NOMINAL				

NOTES:

1. INSULATION RUNDOWN.
2. THREE LEADS.

THIS OUTLINE DOES NOT MEET THE MINIMUM CRITERIA ESTABLISHED BY JS-10 FOR REGISTRATION.

TO 3

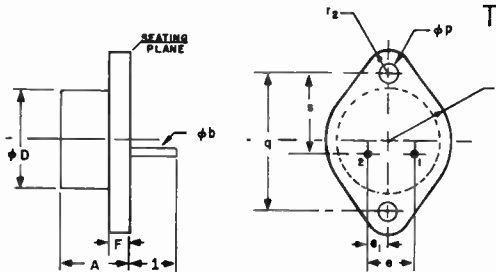

SYMBOL	INCHES		MILLIMETERS		NOTES
	MIN.	MAX.	MIN.	MAX.	
A	.250	.450	6.35	11.43	
ϕb	.038	.043	.97	1.09	2
ϕD		.875		22.23	
e	.420	.440	10.67	11.18	
e_1	.205	.225	5.21	5.72	
F		.135		3.43	
l	.312		7.92		2
ϕp	.151	.161	3.84	4.09	
q	1.177	1.197	29.90	30.40	
r_1		.525		13.34	
r_2		.188		4.78	
s	.655	.675	16.64	17.15	1

NOTES:

1. THESE DIMENSIONS SHOULD BE MEASURED AT POINTS .050" (1.27 MM) TO .055" (1.40 MM) BELOW SEATING PLANE. WHEN GAGE IS NOT USED, MEASUREMENT WILL BE MADE AT SEATING PLANE.

2. TWO LEADS _____

THIS OUTLINE DOES NOT MEET THE MINIMUM CRITERIA ESTABLISHED BY JS-10 FOR REGISTRATION

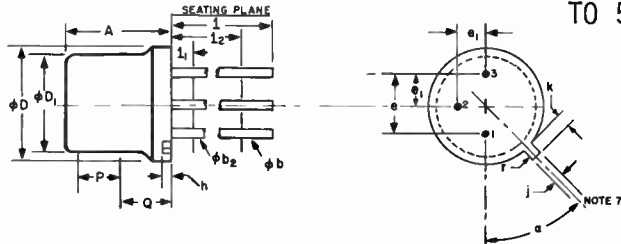

TO 5

SYMBOL	INCHES		MILLIMETERS		NOTES
	MIN.	MAX.	MIN.	MAX.	
A	.240	.260	6.10	6.60	
ϕb	.016	.021	.406	.533	2
ϕb_2	.016	.019	.406	.483	2
ϕD	.335	.370	8.51	9.40	
ϕD_1	.305	.335	7.75	8.51	
e	.200 T.P.		5.08 T.P.		4, 5
e ₁	.100 T.P.		2.54 T.P.		5
h	.009	.125	.229	3.18	
j	.028	.034	.711	.864	5
k	.029	.045	.737	1.14	3, 5
l	1.500		38.10		2
l ₁		.050		1.27	2
l ₂	.250		6.35		2
P	.100		2.54		1
Q					6
r		.007		.179	
a	45° T.P.				5, 7

NOTES:

- THIS ZONE IS CONTROLLED FOR AUTOMATIC HANDLING. THE VARIATION IN ACTUAL DIAMETER WITHIN THE ZONE SHALL NOT EXCEED .010" (.254 MM).
- (THREE LEADS) ϕb_2 APPLIES BETWEEN l_1 AND l_2 . ϕb APPLIES BETWEEN l_2 AND 1.5" (38.10 MM) FROM SEATING PLANE. DIAMETER IS UNCONTROLLED IN l_1 AND BEYOND 1.5" (38.10 MM) FROM SEATING PLANE.
- MEASURED FROM MAXIMUM DIAMETER OF THE ACTUAL DEVICE.
- LEADS HAVING MAXIMUM DIAMETER .019" (.483 MM) MEASURED IN GAGING PLANE .054" (1.37 MM) + .001" (.025 MM) - .000" (.000 MM) BELOW THE SEATING PLANE OF THE DEVICE SHALL BE WITHIN .007" (.178 MM) OF THEIR TRUE POSITIONS RELATIVE TO THE MAXIMUM-WIDTH TAB.
- THE DEVICE MAY BE MEASURED BY DIRECT METHODS OR BY THE GAGE AND GAGING PROCEDURE DESCRIBED ON GAGE DRAWING GS-1.
- DETAILS OF OUTLINE IN THIS ZONE OPTIONAL.
- TAB CENTERLINE.

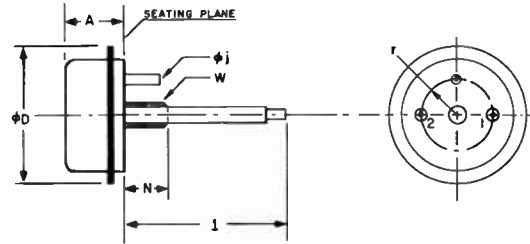

TO 6

SYMBOL	INCHES		MILLIMETERS		NOTES
	MIN.	MAX.	MIN.	MAX.	
A		.625		15.88	
ϕD		1.188		30.18	
l	1.625		41.28		
ϕj	.120 NOMINAL		3.05 NOMINAL		1
N	.438 NOMINAL		11.13 NOMINAL		
r	.345 NOMINAL		8.76 NOMINAL		
W					2

NOTES:

- INSULATED LOCATOR PIN.
- 10-32 UNF-2A. MAXIMUM PITCH DIAMETER OF PLATED THREADS SHALL BE BASIC PITCH DIAMETER .1697" (4.31 MM) REFERENCE (SCREW THREAD STANDARDS FOR FEDERAL SERVICES 1957) HANDBOOK H28 1957 P1.

THIS OUTLINE DOES NOT MEET THE MINIMUM CRITERIA ESTABLISHED BY JS-10 FOR REGISTRATION.

TO 7

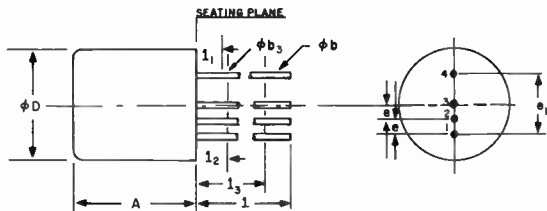

SYMBOL	INCHES		MILLIMETERS		NOTES
	MIN.	MAX.	MIN.	MAX.	
A		.375		9.53	
ϕb	.016	.021	.406	.533	2
ϕb_3	.016	.019	.406	.483	2
ϕD		.360		9.14	
e	.041	.055	1.04	1.40	
e_1	.185	.199	4.70	5.05	
l	1.500		38.10		
l_1		.050		1.27	2
l_2		.080		2.03	1, 2
l_3	.250		6.35		2

NOTES:

1. EXTERNALLY COATED DEVICES SHALL NOT HAVE COATING ON THE LEADS BEYOND THIS ZONE.
2. (FOUR LEADS) ϕb_3 APPLIES BETWEEN l_1 AND l_3 . ϕb APPLIES BETWEEN l_3 AND 1.5" (38.10 MM) FROM SEATING PLANE. DIAMETER IS UNCONTROLLED IN l_1 AND BEYOND 1.5" (38.10 MM) FROM SEATING PLANE.

THIS OUTLINE DOES NOT MEET THE MINIMUM CRITERIA ESTABLISHED BY JS-10 FOR REGISTRATION.

TO 8

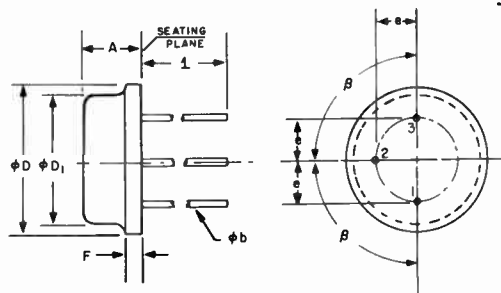

SYMBOL	INCHES		MILLIMETERS		NOTES
	MIN.	MAX.	MIN.	MAX.	
A	.270	.330	6.86	8.38	
ϕb	.027	.033	.686	.838	1
ϕD	.550	.650	13.97	16.51	
ϕD_1	.444	.524	11.28	13.31	
e	.136	.146	3.45	3.71	
e_1		.115		2.92	
l	.360	.440	9.14	11.18	1
β	90° NOMINAL				

NOTES:

1. THREE LEADS.

THIS OUTLINE DOES NOT MEET THE MINIMUM CRITERIA ESTABLISHED BY JS-10 FOR

REGISTRATION

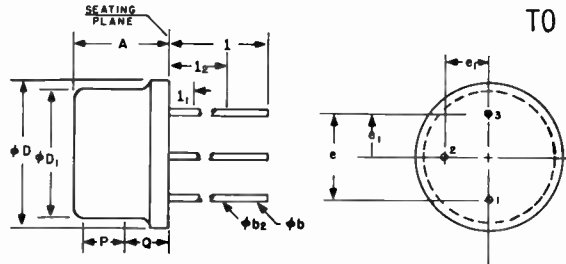

TO 9

SYMBOL	INCHES		MILLIMETERS		NOTES
	MIN.	MAX.	MIN.	MAX.	
A	.200	.260	5.08	6.60	
ϕb	.016	.021	.406	.533	2
ϕb_2	.016	.019	.406	.483	2
ϕD	.290	.370	7.37	9.40	
ϕD_1	.275	.335	6.99	8.51	
e	.200 T.P.		5.08 T.P.		3
e ₁	.100 T.P.		2.54 T.P.		
1	.500		12.70		
1 ₁		.050		1.27	
1 ₂	.250		6.35		
P	.065		1.65		1
Q		.155		3.94	4

NOTES:

- THE VARIATION IN ACTUAL DIAMETER WITHIN THIS ZONE SHALL NOT EXCEED .010" (.254 MM).
- (THREE LEADS) ϕb_2 APPLIES BETWEEN 1₁ AND 1₂. ϕb APPLIES BETWEEN 1₂ AND .5" (12.70 MM) FROM SEATING PLANE. DIAMETER IS UNCONTROLLED IN 1₁ AND BEYOND .5" (12.70 MM) FROM SEATING PLANE.
- LEADS HAVING A MAXIMUM DIAMETER .019" (.483 MM) MEASURED IN A GAGING PLANE OF .054" (1.37 MM) + .001" (.025 MM) - .000" (.000 MM) BELOW THE SEATING PLANE OF THE DEVICE SHALL BE WITHIN .007" (1.78 MM) OF THEIR TRUE POSITIONS (T.P.).
- DETAILS OF OUTLINE IN THIS ZONE OPTIONAL.

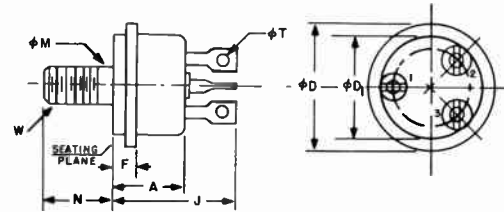

TO 10

SYMBOL	INCHES		MILLIMETERS		NOTES
	MIN.	MAX.	MIN.	MAX.	
A	.290	.440	7.37	11.18	
ϕD		.650		16.51	
ϕD_1	.410	.560	10.41	14.22	
F	.060	.330	1.52	8.38	
J		.650		16.51	
ϕM	.163	.189	4.14	4.80	3
N	.335	.375	8.51	9.53	
ϕT	.040		1.02		1
W					2, 3

NOTES:

- ANGULAR ORIENTATION OF INDIVIDUAL SOLDERED TERMINALS IS UNDEFINED.
- 10-32 UNF-2A. MAXIMUM PITCH DIAMETER OF PLATED THREADS SHALL BE BASIC PITCH DIAMETER .1697" (4.31 MM) REFERENCE (SCREW THREAD STANDARDS FOR FEDERAL SERVICES 1957) HANDBOOK H28 1957 P1.
- COMPLETE THREADS SHALL EXTEND TO WITHIN 2-1/2 THREADS OF THE SEATING PLANE.

THIS OUTLINE DOES NOT MEET THE MINIMUM CRITERIA ESTABLISHED BY JS-10 FOR REGISTRATION.

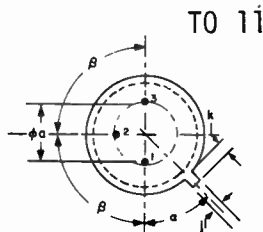
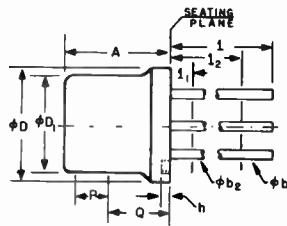

TO 11

SYMBOL	INCHES		MILLIMETERS		NOTES
	MIN.	MAX.	MIN.	MAX.	
ϕa	.190	.210	4.83	5.33	
A	.360	.390	9.14	9.91	
ϕb	.016	.021	.406	.533	2
ϕb_2	.016	.019	.406	.483	2
ϕD		.370		9.40	
ϕD_1	.305	.335	7.75	8.51	
h	.009	.125	.229	3.18	
j	.028	.034	.711	.864	
k	.029	.737			3
l	1.500		38.10		2
l_1		.050		1.27	2
l_2	.250		6.35		2
P	.200		5.08		1
Q					4
α	45° NOMINAL				
β	90° NOMINAL				

NOTES:

- THIS ZONE IS CONTROLLED FOR AUTOMATIC HANDLING. THE VARIATION IN ACTUAL DIAMETER WITHIN THIS ZONE SHALL NOT EXCEED .010" (.254 MM).
- (THREE LEADS) ϕb_2 APPLIES BETWEEN l_1 AND l_2 . ϕb APPLIES BETWEEN l_2 AND 1.5" (38.10 MM) FROM SEATING PLANE. DIAMETER IS UNCONTROLLED IN l_1 AND BEYOND 1.5" (38.10 MM) FROM SEATING PLANE.
- MEASURED FROM MAXIMUM DIAMETER OF THE ACTUAL DEVICE.
- DETAILS OF OUTLINE IN THIS ZONE OPTIONAL. THIS OUTLINE DOES NOT MEET THE MINIMUM CRITERIA ESTABLISHED BY JS-10 FOR REGISTRATION.

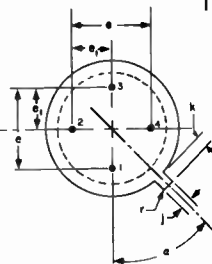
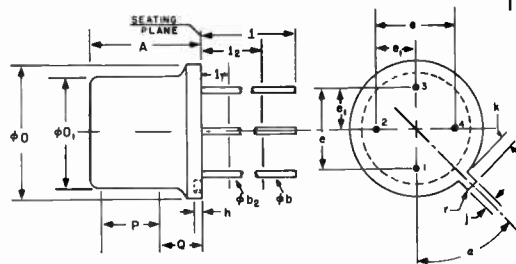

TO 12

SYMBOL	INCHES		MILLIMETERS		NOTES
	MIN.	MAX.	MIN.	MAX.	
A	.240	.260	6.10	6.60	
ϕb	.016	.021	.406	.533	2
ϕb_2	.016	.019	.406	.483	2
ϕD	.335	.370	8.51	9.40	
ϕD_1	.305	.335	7.75	8.51	
e	.200	T.P.	5.08 T.P.		4, 5
e_1	.100	T.P.	2.54 T.P.		5
h	.009	.125	.229	3.18	
j	.028	.034	.711	.864	5
k	.029	.065	.737	1.14	3, 5
l	.500		12.70		2
l_1		.050		1.27	2
l_2	.250		6.35		2
P	.100		2.54		1
Q					6
r		.007		.178	
α	45° T.P.				5, 7

NOTES:

- THIS ZONE IS UNCONTROLLED FOR AUTOMATIC HANDLING. THE VARIATION IN ACTUAL DIAMETER WITHIN THIS ZONE SHALL NOT EXCEED .010" (.254 MM).
- (FOUR LEADS) ϕb_2 APPLIES BETWEEN l_1 AND l_2 . ϕb APPLIES BETWEEN l_2 AND .5" (12.70 MM) FROM SEATING PLANE. DIAMETER IS UNCONTROLLED IN l_1 AND BEYOND .5" (12.70 MM) FROM SEATING PLANE.
- MEASURED FROM MAXIMUM DIAMETER OF THE ACTUAL DEVICE.
- LEADS HAVING MAXIMUM DIAMETER .019" (.483 MM) MEASURED IN A GAGING PLANE .054" (1.37 MM) + .001" (.025 MM) - .000" (.000 MM) BELOW THE SEATING PLANE OF THE DEVICE SHALL BE WITHIN .007" (.178 MM) OF THEIR TRUE POSITIONS RELATIVE TO THE MAXIMUM-WIDTH TAB.
- THE DEVICE MAY BE MEASURED BY DIRECT METHODS OR BY THE GAGE AND GAGING PROCEDURE DESCRIBED ON GAGE DRAWING GS-1.
- DETAILS OF OUTLINE IN THIS ZONE OPTIONAL.
- TAB CENTERLINE.

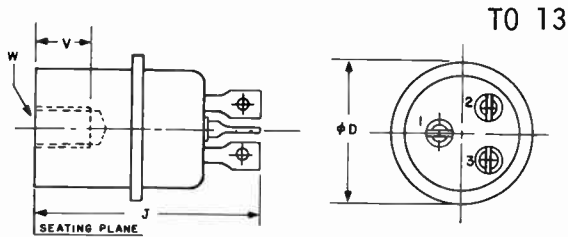

TO 13

SYMBOL	INCHES		MILLIMETERS		NOTES
	MIN.	MAX.	MIN.	MAX.	
ϕD		.650		16.51	
J		1.040		26.42	
V	.250		6.35		
W					1

NOTES:

- 1/4-28 UNF-2B.

THIS OUTLINE DOES NOT MEET THE MINIMUM CRITERIA ESTABLISHED BY JS-10 FOR REGISTRATION.

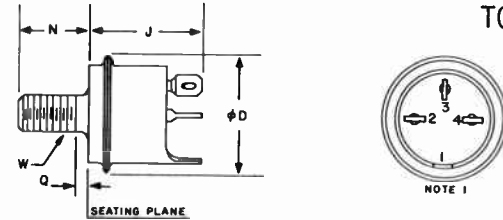

TO 14

SYMBOL	INCHES		MILLIMETERS		NOTES
	MIN.	MAX.	MIN.	MAX.	
ϕD		.650		16.51	
J		.650		16.51	
N	.335	.375	8.51	9.53	
Q		.080		2.03	
W					2

NOTES:

- TERMINALS MAY BE REFERRED TO BY NUMBER AS FOLLOWS: TERMINAL NO. 1 IS THE ODD TERMINAL AND CONNECTED TO THE CASE. OTHER TERMINALS ARE NUMBERED CLOCKWISE FROM NO. 1.
- 10-32 UNF-2A. MAXIMUM PITCH DIAMETER OF PLATED THREADS SHALL BE BASIC PITCH DIAMETER .1697" (4.31 MM) REFERENCE (SCREW THREAD STANDARDS FOR FEDERAL SERVICES 1957) HANDBOOK H28 1957 P1.

THIS OUTLINE DOES NOT MEET THE MINIMUM CRITERIA ESTABLISHED BY JS-10 FOR REGISTRATION.

TO 15

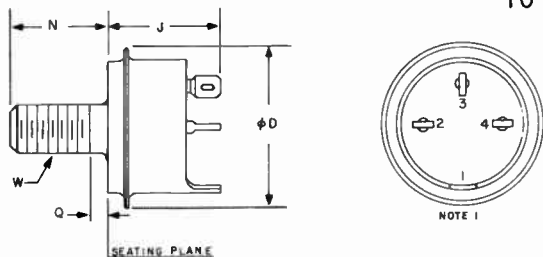

SYMBOL	INCHES		MILLIMETERS		NOTES
	MIN.	MAX.	MIN.	MAX.	
ϕD		.850		21.59	
J		.650		16.51	
N	.460	.500	11.68	12.70	
Q		.100		2.54	
W					2

NOTES:

- TERMINALS MAY BE REFERRED TO BY NUMBER AS FOLLOWS: TERMINAL NO. 1 IS THE ODD TERMINAL AND CONNECTED TO THE CASE. OTHER TERMINALS ARE NUMBERED CLOCKWISE FROM NO. 1.
- 1/4-28 UNF-2A. MAXIMUM PITCH DIAMETER OF PLATED THREADS SHALL BE BASIC PITCH DIAMETER .2268" (5.76 MM) REFERENCE (SCREW THREAD STANDARDS FOR FEDERAL SERVICES 1957) HANDBOOK H28 P1.

THIS OUTLINE DOES NOT MEET THE MINIMUM CRITERIA ESTABLISHED BY JS-10 FOR
REGISTRATION

TO 16

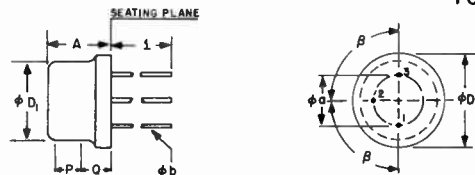

SYMBOL	INCHES		MILLIMETERS		NOTES
	MIN.	MAX.	MIN.	MAX.	
ϕa	.190	.210	4.83	5.33	
A	.200	.260	5.08	6.60	
ϕb	.016	.019	.406	.483	2
ϕD	.370 NOMINAL		9.40 NOMINAL		
ϕD_1	.275	.335	6.99	8.51	
1	.500		12.70		
P	.100		2.54		1
Q					3
β	90° NOMINAL				

NOTES:

- THIS ZONE IS CONTROLLED FOR AUTOMATIC HANDLING. THE VARIATION IN ACTUAL DIAMETER WITHIN THIS ZONE SHALL NOT EXCEED .010" (.254 MM).
- THE SPECIFIED LEAD DIAMETER APPLIES IN THE ZONE BETWEEN .050" (1.27 MM) AND .250" (6.35 MM) FROM THE SEATING PLANE BETWEEN .250" (6.35 MM) AND .500" (12.70 MM) MAXIMUM OF .021" (.533 MM) DIAMETER IS HELD. OUTSIDE OF THESE ZONES THE LEAD DIAMETER IS NOT CONTROLLED.
- DETAILS OF OUTLINE IN THIS ZONE OPTIONAL.

THIS OUTLINE DOES NOT MEET THE MINIMUM CRITERIA ESTABLISHED BY JS-10 FOR
REGISTRATION.

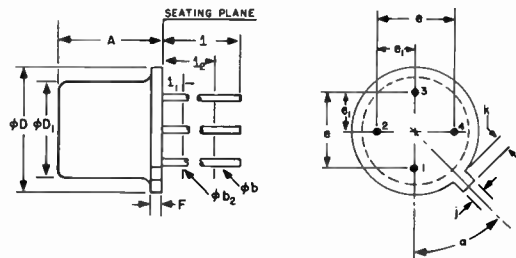

TO 17

SYMBOL	INCHES		MILLIMETERS		NOTES
	MIN.	MAX.	MIN.	MAX.	
A	.165	.210	4.19	5.33	
ϕb	.016	.021	.406	.533	1
ϕb_2	.016	.019	.406	.483	1
ϕD	.185	.215	4.70	5.46	
ϕD_1	.150	.168	3.81	4.27	
e	.071 T.P.		1.80 T.P.		2
e_1	.036 T.P.		.914 T.P.		
F	.030		.762		
j	.030	.045	.762	1.14	
k	.028	.048	.711	1.22	4
l	.500		12.70		1
l_1	.050		1.27		1
l_2	.250		6.35		1
a	45° T.P.				3

NOTES:

- (FOUR LEADS) ϕb_2 APPLIES BETWEEN l_1 AND l_2 . ϕb APPLIES BETWEEN l_2 AND .5" (12.70 MM) FROM SEATING PLANE. DIAMETER IS UNCONTROLLED IN l_1 AND BEYOND .5" (12.70 MM) FROM SEATING PLANE.
- LEADS HAVING MAXIMUM DIAMETERS .019" (.483 MM) MEASURED AT A GAGING PLANE .054" (1.37 MM) + .001" (.025 MM) - .000" (.000 MM) BELOW THE SEATING PLANE OF THE DEVICE SHALL BE WITHIN .007" (.178 MM) OF THEIR TRUE POSITIONS RELATIVE TO A MAXIMUM-WIDTH TAB AND TO THE .215" (5.46 MM) DIAMETER.
- TAB CENTERLINE. INDEX TAB FOR VISUAL ORIENTATION ONLY.
- MEASURED FROM MAXIMUM DIAMETER OF ACTUAL DEVICE.

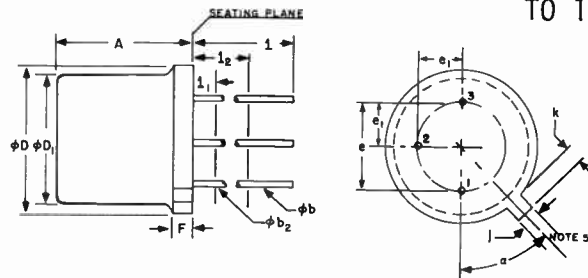

TO 18

SYMBOL	INCHES		MILLIMETERS		NOTES
	MIN.	MAX.	MIN.	MAX.	
A	.170	.210	4.32	5.33	
ϕb	.016	.021	.406	.533	1
ϕb_2	.016	.019	.406	.483	1
ϕD	.209	.230	5.31	5.84	
ϕD_1	.178	.195	4.52	4.95	
e	.100 T.P.		2.54 T.P.		2, 4
e_1	.050 T.P.		1.27 T.P.		2, 4
F	.030		.762		
j	.036	.046	.914	1.17	4
k	.028	.048	.711	1.22	3
l	.500		12.70		1
l_1	.050		1.27		1
l_2	.250		6.35		1
a	45° T.P.				5

NOTES:

- (THREE LEADS) ϕb_2 APPLIES BETWEEN l_1 AND l_2 . ϕb APPLIES BETWEEN l_2 AND .5" (12.70 MM) FROM SEATING PLANE. DIAMETER IS UNCONTROLLED IN l_1 AND BEYOND .5" (12.70 MM) FROM SEATING PLANE.
- LEADS HAVING MAXIMUM DIAMETER .019" (.483 MM) MEASURED IN GAGING PLANE .054" (1.37 MM) + .001" (.025 MM) - .000" (.000 MM) BELOW THE SEATING PLANE OF THE DEVICE SHALL BE WITHIN .007" (.178 MM) OF THEIR TRUE POSITIONS RELATIVE TO A MAXIMUM-WIDTH TAB.
- MEASURED FROM MAXIMUM DIAMETER OF THE ACTUAL DEVICE.
- THE DEVICE MAY BE MEASURED BY DIRECT METHODS OR BY THE GAGE AND GAGING PROCEDURE DESCRIBED ON GAGE DRAWING GS-2.
- TAB CENTERLINE.

TO 22

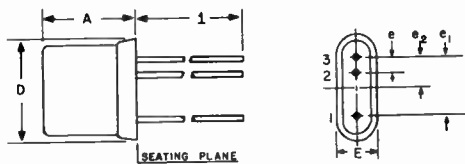

SYMBOL	INCHES		MILLIMETERS		NOTES
	MIN.	MAX.	MIN.	MAX.	
A		.320		B.13	
D		.340		B.64	
e	.041	.055	1.04	1.40	
e ₁	.185	.199	4.70	5.05	
E		.190		4.83	
1	1.500		38.10		
Q	.089	.103	2.26	2.62	

TO 23

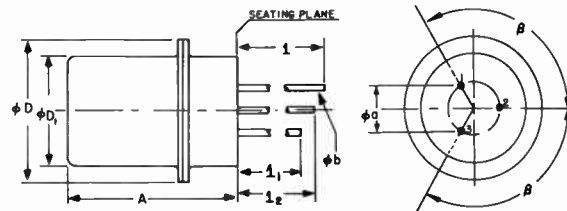

SYMBOL	INCHES		MILLIMETERS		NOTES
	MIN.	MAX.	MIN.	MAX.	
ϕ_a	.052 NOMINAL		1.32 NOMINAL		
A		.180		4.57	
ϕ_b	.013 NOMINAL		.330 NOMINAL		1
ϕD		.140		3.56	
ϕD_1		.115		2.92	
1	1.615	1.645	41.02	41.78	1
1 ₁	1.490	1.520	37.85	38.61	1
1 ₂	1.552	1.582	39.42	40.18	1
β	120° NOMINAL				

NOTES:

1. THREE LEADS.

THIS OUTLINE DOES NOT MEET THE MINIMUM CRITERIA ESTABLISHED BY JS-10 FOR REGISTRATION.

THIS OUTLINE DOES NOT MEET THE MINIMUM CRITERIA ESTABLISHED BY JS-10 FOR REGISTRATION.

TO 24

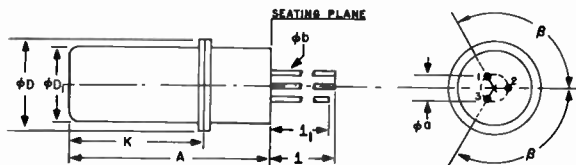

SYMBOL	INCHES		MILLIMETERS		NOTES
	MIN.	MAX.	MIN.	MAX.	
ϕa	.070 NOMINAL		1.79 NOMINAL		
A	.425	.475	10.80	12.07	
ϕb	.016 NOMINAL		.406 NOMINAL		1
ϕD	.195	.225	4.95	5.72	
ϕD_1	.161	.179	4.09	4.55	
K	.285	.315	7.24	8.00	
1	1.500	1.687	38.10	42.85	1, 2
1_1	1.450	1.637	36.83	41.58	1, 2
β	120° NOMINAL				

NOTES:

1. THREE LEADS.
2. THE MINIMUM DIFFERENCE BETWEEN 1 AND 1_1 SHALL BE .062" (1.57 MM).

THIS OUTLINE DOES NOT MEET THE MINIMUM CRITERIA ESTABLISHED BY JS-10 FOR REGISTRATION.

TO 25

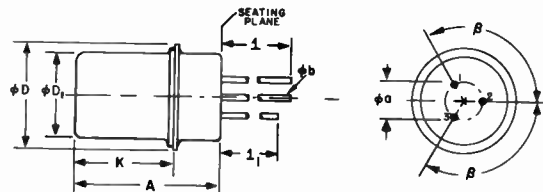

SYMBOL	INCHES		MILLIMETERS		NOTES
	MIN.	MAX.	MIN.	MAX.	
ϕa	.156 NOMINAL		3.96 NOMINAL		
A		.470		11.94	
ϕb	.020 NOMINAL		.508 NOMINAL		1
ϕD		.330		8.38	
ϕD_1		.280		7.11	
K		.295		7.49	
1	1.500		38.10		1, 2
1_1	1.438		36.53		1, 2
β	120° NOMINAL				

NOTES:

1. THREE LEADS.
2. THE MINIMUM DIFFERENCE BETWEEN 1 AND 1_1 SHALL BE .062" (1.57 MM).

THIS OUTLINE DOES NOT MEET THE MINIMUM CRITERIA ESTABLISHED BY JS-10 FOR REGISTRATION.

TO 26

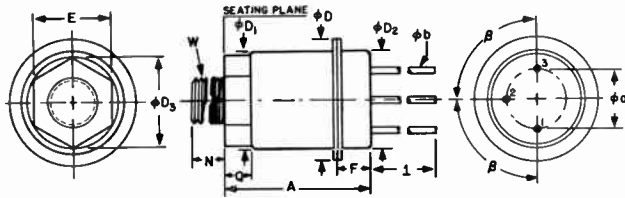

SYMBOL	INCHES		MILLIMETERS		NOTES
	MIN.	MAX.	MIN.	MAX.	
ϕa		.200		5.08	
A	.480	.510	12.19	12.95	
ϕb	.016	.019	.406	.482	2
ϕD	.360	.370	9.14	9.40	
ϕD_1	.295	.305	7.49	7.75	
ϕD_2	.290	.310	7.37	7.87	
ϕD_3		.289		7.34	
E		.250		6.35	
F	.110	.130	2.79	3.30	
I	1.500	1.688	38.10	42.88	2
N		.375		9.53	
Q	.105	.115	2.67	2.92	
W					1
β	90° NOMINAL				

NOTES:

- 8-32 UNF-2A.
- THREE LEADS.

THIS OUTLINE DOES NOT MEET THE MINIMUM CRITERIA ESTABLISHED BY JS-10 FOR REGISTRATION.

TO 27

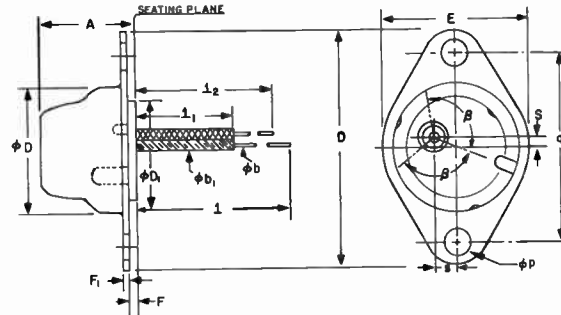

SYMBOL	INCHES		MILLIMETERS		NOTES
	MIN.	MAX.	MIN.	MAX.	
A		.510		12.95	
ϕb	.016 NOMINAL		.406 NOMINAL		
ϕD_1		.065		1.65	
ϕD		.875		22.23	
ϕD_1		.625		15.88	
D		1.625		41.28	
E		1.125		28.58	
F	.040		1.02		
F ₁	.030 NOMINAL		.762 NOMINAL		
I	1.500		38.10		
I ₁	.750		19.05		
I ₂	1.420		36.07		
ϕp	.156 NOMINAL		3.96 NOMINAL		
q	1.187 NOMINAL		30.15 NOMINAL		
s	.049 NOMINAL		1.24 NOMINAL		
s	.135 NOMINAL		3.43 NOMINAL		
β	120° NOMINAL				

THIS OUTLINE DOES NOT MEET THE MINIMUM CRITERIA ESTABLISHED BY JS-10 FOR REGISTRATION.

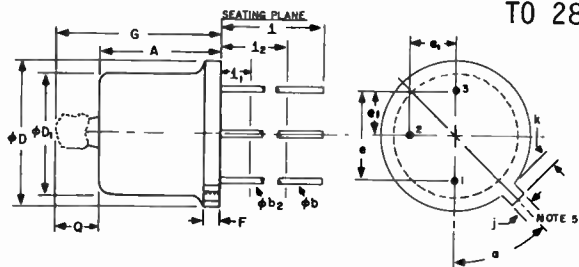

SYMBOL	INCHES		MILLIMETERS		NOTES
	MIN.	MAX.	MIN.	MAX.	
A	.170	.210	4.32	5.33	
ϕb	.016	.021	.406	.533	2
ϕb_2	.016	.019	.406	.483	2
ϕD	.209	.230	5.31	5.84	
ϕD_1	.178	.195	4.52	4.95	
e	.100 T.P.		2.54 T.P.		1
e ₁	.050 T.P.		1.27 T.P.		1
F		.030		.762	
G		.350		8.89	
j	.036	.046	.914	1.17	1
k	.028	.048	.711	1.22	1, 3
l	1.500		38.10		2
l ₁		.050		1.27	2
l ₂	.250		6.35		2
Q					4
a	45° T.P.				1, 5

NOTES:

1. MAXIMUM DIAMETER LEADS MEASURED AT POINTS $.054'' (1.37 \text{ MM}) + .001'' (.025 \text{ MM}) - .000'' (.000 \text{ MM})$ BELOW THE SEATING PLANE OF THE DEVICE SHALL BE WITHIN $.007'' (.178 \text{ MM})$ OF THEIR TRUE POSITIONS RELATIVE TO THE MAXIMUM-WIDTH TAB AND MAXIMUM DIAMETER PLANGE.
2. (THREE LEADS) ϕb_2 APPLIES BETWEEN l₁ AND l₂. ϕb APPLIES BETWEEN l₂ AND 1.5" (38.10 MM) FROM SEATING PLANE. DIAMETER IS UNCONTROLLED IN l₁ AND BEYOND 1.5" (38.10 MM) FROM SEATING PLANE.
3. MEASURED FROM MAXIMUM DIAMETER OF ACTUAL DEVICE.
4. DETAILS OF OUTLINE IN THIS ZONE OPTIONAL.
5. TAB CENTERLINE.

TO 28

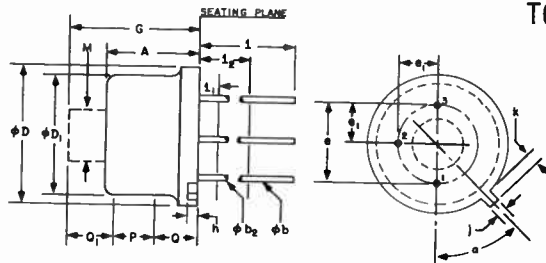

SYMBOL	INCHES		MILLIMETERS		NOTES
	MIN.	MAX.	MIN.	MAX.	
A	.200	.260	5.08	6.60	
ϕb	.016	.021	.406	.533	2
ϕb_2	.016	.019	.406	.483	2
ϕD	.335	.370	8.51	9.40	
ϕD_1	.305	.335	7.75	8.51	
e	.200 T.P.		5.08 T.P.		4
e ₁	.100 T.P.		2.54 T.P.		4
G		.360		9.14	
h	.009	.125	.229	3.18	
j	.028	.034	.711	.864	4, 5
k	.029	.045	.737	1.14	3, 4, 5
l	1.500		38.10		
l ₁		.050		1.27	
l ₂	.250		6.35		
M		.150		3.81	
P	.100		2.54		1
Q					6
Q ₁					6
a	45° T.P.				5, 7

NOTES:

1. THIS ZONE IS CONTROLLED FOR AUTOMATIC HANDLING. THE VARIATION IN ACTUAL DIAMETER WITHIN THE ZONE SHALL NOT EXCEED $.010'' (.254 \text{ MM})$.
2. (THREE LEADS) ϕb_2 APPLIES BETWEEN l₁ AND l₂. ϕb APPLIES BETWEEN l₂ AND 1.5" (38.10 MM) FROM SEATING PLANE. DIAMETER IS UNCONTROLLED IN l₁ AND BEYOND 1.5" (38.10 MM) FROM SEATING PLANE.
3. MEASURED FROM MAXIMUM DIAMETER OF THE ACTUAL DEVICE.
4. LEADS HAVING MAXIMUM DIAMETER $.019'' (.483 \text{ MM})$ MEASURED IN GAGING PLANE $.054'' (1.37 \text{ MM}) + .001'' (.025 \text{ MM}) - .000'' (.000 \text{ MM})$ BELOW THE SEATING PLANE OF THE DEVICE SHALL BE WITHIN $.007'' (.178 \text{ MM})$ OF THEIR TRUE POSITIONS RELATIVE TO A MAXIMUM-WIDTH TAB.
5. THE DEVICE MAY BE MEASURED BY DIRECT METHODS OR BY THE GAGE AND GAGING PROCEDURE DESCRIBED ON GAGE DRAWING GS-1.
6. DETAILS OF OUTLINE IN THIS ZONE OPTIONAL.
7. TAB CENTERLINE.

TO 29

TO 30

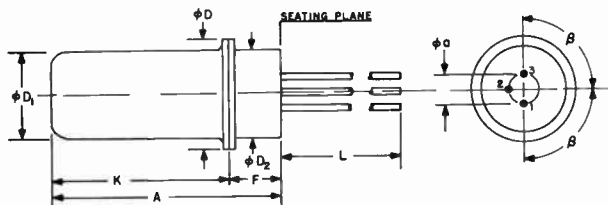

SYMBOL	INCHES		MILLIMETERS		NOTES
	MIN.	MAX.	MIN.	MAX.	
ϕa	.065	.075	1.65	1.91	
A	.375	.425	9.53	10.80	
ϕD	.195	.225	4.95	5.72	
ϕD_1	.160	.180	4.06	4.57	
ϕD_2	.166	.176	4.22	4.47	
F	.095	.105	2.41	2.67	
K	.285	.315	7.24	8.00	
L	1.500	1.688	38.10	42.88	
β	90° NOMINAL				

THIS OUTLINE DOES NOT MEET THE MINIMUM CRITERIA ESTABLISHED BY JS-10 FOR REGISTRATION.

TO 31

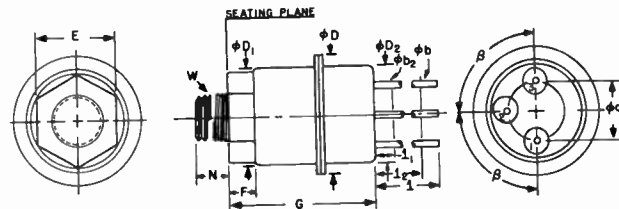

SYMBOL	INCHES		MILLIMETERS		NOTES
	MIN.	MAX.	MIN.	MAX.	
A	.360	.390	9.14	9.91	
ϕa	.200 NOMINAL		5.08 NOMINAL		
ϕb		.021		.533	1
ϕb_2	.016	.019	.406	.483	1
ϕD	.360	.370	9.14	9.40	
ϕD_1	.295	.305	7.49	7.75	
ϕD_2	.290	.310	7.37	7.87	
E	.250		6.35		2
F	.105	.115	2.67	2.92	
I	1.500	1.688	38.10	42.88	
I_1		.050		1.27	
I_2	.250		6.35		
N	.375 NOMINAL		9.53 NOMINAL		
W					3
β	90° NOMINAL				

NOTES:

- (THREE LEADS) ϕb_2 APPLIES BETWEEN I_1 AND I_2 . ϕb APPLIES BETWEEN I_2 AND 1.5" (38.10 MM) FROM SEATING PLANE. DIAMETER IS UNCONTROLLED IN I_1 AND BEYOND 1.5" (38.10 MM) FROM SEATING PLANE.
- HEX FOR STANDARD 1/4" IGNITION WRENCH.
- 8-32 UNC-2A.

THIS OUTLINE DOES NOT MEET THE MINIMUM CRITERIA ESTABLISHED BY JS-10 FOR REGISTRATION.

TO 32

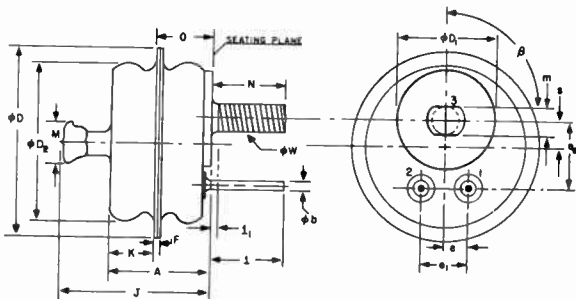

SYMBOL	INCHES		MILLIMETERS		NOTES
	MIN.	MAX.	MIN.	MAX.	
A		.475		12.07	
Φb	.029	.033	.737	.838	
ΦD		.885		22.48	
ΦD1		.455		11.56	
ΦD2		.685		17.40	
e	.100 T.P.		2.54 T.P.		1
e1	.200 T.P.		5.08 T.P.		1
e2	.300 T.P.		7.62 T.P.		1
P	.020	.040	.508	1.02	
J		.690		17.53	
K	.165		4.19		
L	.281		7.14		
l1		.015		.381	1, 3
l		.250		6.35	
m	.122	.125	3.10	3.18	
N		.312		7.92	
Q		.310		7.87	
a	.105 T.P.		2.67 T.P.		1
ΦN					2
β	88°	92°	88°	92°	

NOTES:

- MAXIMUM SIZE LEADS AND STUD MUST BE WITHIN .0055" (.152 MM) OF THE EXACT POSITIONS SHOWN WITH RESPECT TO THE .885" (22.48 MM) MAXIMUM DIAMETER MEASURED AT POINTS .015" (.381 MM) MAXIMUM BELOW SEATING PLANE.
 - 190-32 UNF-2A. MAXIMUM PITCH DIAMETER OF PLATED THREADS SHALL BE BASIC PITCH DIAMETER .190" (4.83 MM) REFERENCE (SCREW THREAD STANDARDS FOR FEDERAL SPECIFICATIONS 1957) HANDBOOK H28 1957 P1.
 - LEAD DIAMETER IN THIS AREA UNRESTRICTED.
- THIS OUTLINE DOES NOT MEET THE MINIMUM CRITERIA ESTABLISHED BY JS-10 FOR REGISTRATION.

TO 33

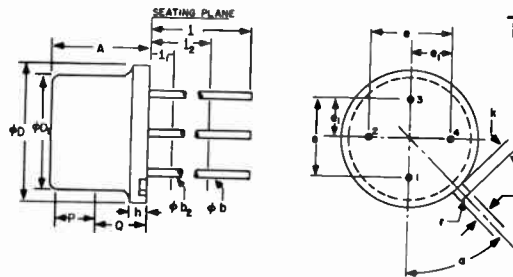

SYMBOL	INCHES		MILLIMETERS		NOTES
	MIN.	MAX.	MIN.	MAX.	
A	.240	.260	6.10	6.60	
Φb	.016	.021	.406	.533	2
Φb2	.016	.019	.406	.483	2
ΦD	.335	.370	8.51	9.40	
ΦD1	.305	.335	7.75	8.51	
e		.200 T.P.		5.08 T.P.	4, 5
e1		.100 T.P.		2.54 T.P.	4, 5
h	.009	.125	.229	3.18	
j	.028	.034	.711	.864	5
k	.029	.045	.737	1.14	3, 5
l	1.500		38.10		2
l1		.050		1.27	2
l2	.250		6.35		2
P	.100		2.54		1
Q					6
r		.007		.178	
a		45° T.P.			4, 5, 7

NOTES:

- THIS DEVICE IS CONTROLLED FOR AUTOMATIC HANDLING. THE VARIATION IN ACTUAL DIAMETER WITHIN THE ZONE SHALL NOT EXCEED .010" (.254 MM).
- (FOUR LEADS) Φb2 APPLIES BETWEEN l1 AND l2. Φb APPLIES BETWEEN l2 AND 1.5" (38.10 MM) FROM SEATING PLANE. DIAMETER IS UNCONTROLLED IN l1 AND BEYOND 1.5" (38.10 MM) FROM SEATING PLANE.
- MEASURED FROM MAXIMUM DIAMETER OF THE ACTUAL DEVICE.
- LEADS HAVING MAXIMUM DIAMETER .019" (.483 MM) MEASURED IN GAGING PLANE .054" (1.37 MM) + .001" (.025 MM) - .000" (.000 MM) BELOW THE SEATING PLANE OF THE DEVICE SHALL BE WITHIN .007" (.178 MM) OF THEIR TRUE POSITIONS RELATIVE TO A MAXIMUM-WIDTH TAB.
- THE DEVICE MAY BE MEASURED BY DIRECT METHODS OR BY THE GAGE AND GAGING PROCEDURE DESCRIBED ON GAGE DRAWING GS-1.
- DETAILS OF OUTLINE IN THIS ZONE OPTIONAL.
- TAB CENTERLINE.

TO 36

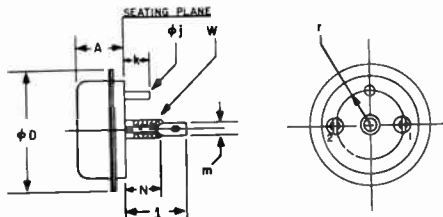

SYMBOL	INCHES		MILLIMETERS		NOTES
	MIN.	MAX.	MIN.	MAX.	
A		.520		13.21	
ϕD		1.250		31.75	
ϕj		.140		3.56	
k		.312		7.92	1
1	.610	.710	15.49	18.03	
m		.190		4.83	
N	.375	.500	9.53	12.70	
r		.345 NOMINAL		8.76	
W					2

NOTES:

1. INSULATED LOCATOR PIN.
2. 10-32 UNF-2A. MAXIMUM FITCH DIAMETER OF PLATED THREADS SHALL BE BASIC FITCH DIAMETER .1697" (4.31 MM) REFERENCE (SCREW THREAD STANDARDS FOR FEDERAL SERVICES 1957) HANDBOOK H2B 1957 P1.

THIS OUTLINE DOES NOT MEET THE MINIMUM CRITERIA ESTABLISHED BY JS-10 FOR REGISTRATION.

TO 37

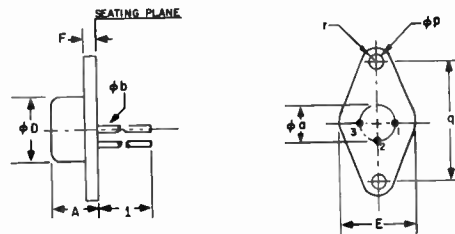

SYMBOL	INCHES		MILLIMETERS		NOTES
	MIN.	MAX.	MIN.	MAX.	
ϕa	.200 NOMINAL		5.08 NOMINAL		
A		.260		6.60	
ϕb	.016	.022	.406	.559	1
ϕD		.320		8.13	
E		.390		9.91	
F		.070		1.78	
1	1.500		38.10		1
ϕp	.120	.130	3.05	3.30	3
q	.552	.572	14.02	14.53	
r		.114		2.90	2

NOTES:

1. THREE LEADS.
2. BOTH ENDS.
3. TWO MOUNTING HOLES.

THIS OUTLINE DOES NOT MEET THE MINIMUM CRITERIA ESTABLISHED BY JS-10 FOR REGISTRATION.

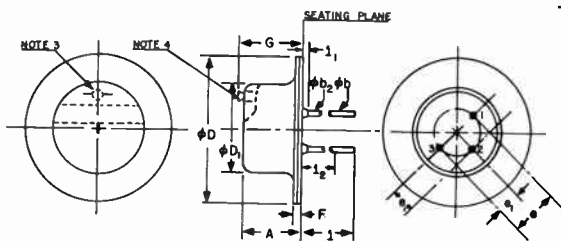

TO 38

SYMBOL	INCHES		MILLIMETERS		NOTES
	MIN.	MAX.	MIN.	MAX.	
A		.330		8.38	
ϕb	.016	.021	.406	.533	2
ϕb_2	.016	.019	.406	.483	2
ϕD	.675	.725	17.15	18.42	
ϕD_1	.470	.500	11.94	12.70	
e	.200 T.P.		5.08 T.P.		1
e ₁	.100 T.P.		2.54 T.P.		1
F		.045		1.14	
G		.375		9.53	
l	.625		15.88		2
l ₁		.050		1.27	2
l ₂	.250		6.35		2

NOTES:

1. MAXIMUM DIAMETER LEADS MEASURED AT A GAGING PLANE $.054'' (1.37 \text{ MM}) + .001'' (.025 \text{ MM}) - .000'' (.000 \text{ MM})$ BELOW THE SEATING PLANE SHALL BE WITHIN $.010'' (.254 \text{ MM})$ OF THEIR TRUE POSITIONS WITH RESPECT TO THE $.725'' (18.42 \text{ MM})$ DIAMETER.

(THREE LEADS) ϕb_2 APPLIES BETWEEN l_1 AND l_2 . ϕb APPLIES BETWEEN l_2 AND $.625'' (15.88 \text{ MM})$ FROM SEATING PLANE. DIAMETER IS UNCONTROLLED BEYOND $.625'' (15.88 \text{ MM})$ FROM SEATING PLANE.

ANGULAR ORIENTATION OF EDGE OPTIONAL.

DETAILS OF OUTLINE OPTIONAL IN THIS AREA.

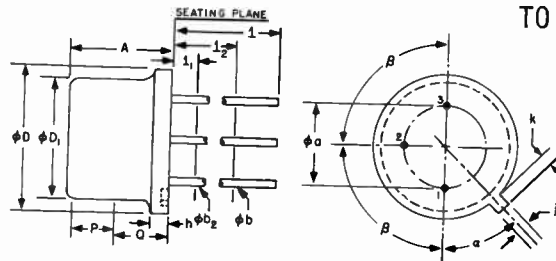

TO 39

SYMBOL	INCHES		MILLIMETERS		NOTES
	MIN.	MAX.	MIN.	MAX.	
ϕa	.190	.210	4.83	5.33	
A	.240	.260	6.10	6.60	
ϕb	.016	.021	.406	.533	2
ϕb_2	.016	.019	.406	.483	2
ϕD	.350	.370	8.89	9.40	
ϕD_1	.315	.335	8.00	8.51	
h	.009	.125	.229	3.18	
j	.028	.034	.711	.864	
k	.029	.040	.737	1.02	3
l	.500		12.70		2
l ₁		.050		1.27	2
l ₂	.250		6.35		2
F	.100		2.54		1
Q					4
α	45° NOMINAL				
β	90° NOMINAL				

NOTES:

1. THIS ZONE IS CONTROLLED FOR AUTOMATIC HANDLING. THE VARIATION IN ACTUAL DIAMETER WITHIN THIS ZONE SHALL NOT EXCEED $.010'' (.254 \text{ MM})$.
2. (THREE LEADS) ϕb_2 APPLIES BETWEEN l_1 AND l_2 . ϕb APPLIES BETWEEN l_2 AND $.5'' (12.70 \text{ MM})$ FROM SEATING PLANE. DIAMETER IS UNCONTROLLED IN l_1 AND BEYOND $.5'' (12.70 \text{ MM})$ FROM SEATING PLANE.
3. MEASURED FROM MAXIMUM DIAMETER OF THE ACTUAL DEVICE.
4. DETAILS OF OUTLINE IN THIS ZONE OPTIONAL.

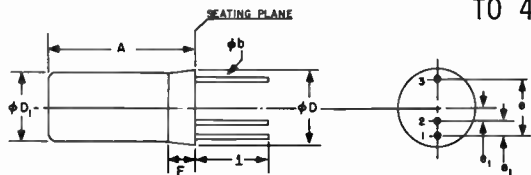

TO 40

SYMBOL	INCHES		MILLIMETERS		NOTES
	MIN.	MAX.	MIN.	MAX.	
A		.495		12.57	
ϕb	.016	.019	.406	.483	1
ϕD		.260		6.60	
ϕD_1		.240		6.10	
e	.185	.199	4.70	5.05	
e_1	.041	.055	1.04	1.40	
F		.120		3.05	
l	.172	.202	4.37	5.13	1

NOTES:

- THREE LEADS.

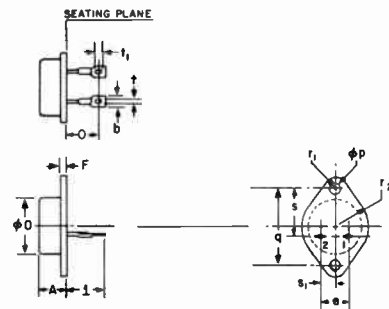

TO 41

SYMBOL	INCHES		MILLIMETERS		NOTES
	MIN.	MAX.	MIN.	MAX.	
A	.250	.450	6.35	11.43	
b	.125	.210	3.18	5.33	1, 2
ϕD		.875		22.23	
e	.420	.440	10.67	11.18	
F		.135		3.43	
l	.560	.680	14.23	17.27	
o	.500	.581	12.70	14.76	
ϕp	.151	.161	3.84	4.09	4
q	1.177	1.197	29.90	30.40	
r_1		.188		4.78	3
r_2		.525		13.34	
s	.655	.675	16.64	17.15	
s_1	.205	.225	5.21	5.72	1
t	.072	.120	1.83	3.05	2
t_1	.072	.170	1.83	4.32	2

NOTES:

- THESE DIMENSIONS SHOULD BE MEASURED AT POINTS .050" (1.27 MM) TO .055" (1.40 MM) BELOW SEATING PLANE. WHEN GAGE IS NOT USED, MEASUREMENT WILL BE MADE AT SEATING PLANE.
- SQUARE OR RADIUS ON END OF TERMINAL AND/OR HOLE OPTIONAL.
- AT BOTH ENDS.
- TWO HOLES.

THIS OUTLINE DOES NOT MEET THE MINIMUM CRITERIA ESTABLISHED BY JS-10 FOR REGISTRATION.

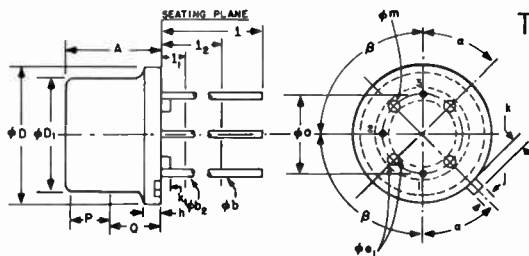

TO 42

SYMBOL	INCHES		MILLIMETERS		NOTES
	MIN.	MAX.	MIN.	MAX.	
ϕa	.190	.210	4.83	5.33	
A	.200	.260	5.08	6.60	
ϕb	.016	.021	.406	.533	2
ϕb_2	.016	.019	.406	.483	2
ϕD	.290	.370	7.37	9.40	
ϕD_1	.290	.335	7.37	8.51	
ϕe_1	.020	.250	.508	6.35	4
h	.009	.125	.229	3.18	
j	.028	.034	.711	.864	
k	.029		.737		
k ₁	.017	.025	.432	.635	
l	1.500		38.10		2
l ₁		.050		1.27	2
l ₂	.250		6.35		2
ϕm	.040	NOMINAL	1.02	NOMINAL	
P	.100		2.54		1
Q					5
α	45° NOMINAL				
β	90° NOMINAL				

NOTES:

- THIS ZONE IS CONTROLLED FOR AUTOMATIC HANDLING. THE VARIATION IN ACTUAL DIAMETER WITHIN THIS ZONE SHALL NOT EXCEED .010" (.254 MM).
- (THREE LEADS) ϕb_2 APPLIES BETWEEN l₁ AND l₂. ϕb APPLIES BETWEEN l₂ AND 1.5" (38.10 MM) FROM SEATING PLANE. DIAMETER IS UNCONTROLLED IN l₁ AND BEYOND 1.5" (38.10 MM) FROM SEATING PLANE.
- MEASURED FROM MAXIMUM DIAMETER OF THE ACTUAL DEVICE.
- FOUR EQUALLY SPACED FEET TO LIE WITHIN THIS ZONE. MINIMUM DISTANCE BETWEEN A LEAD AND A FOOT .031" (.788 MM).
- DETAILS OF OUTLINE IN THIS ZONE OPTIONAL.
THIS OUTLINE DOES NOT MEET THE MINIMUM CRITERIA ESTABLISHED BY JS-10 FOR REGISTRATION.

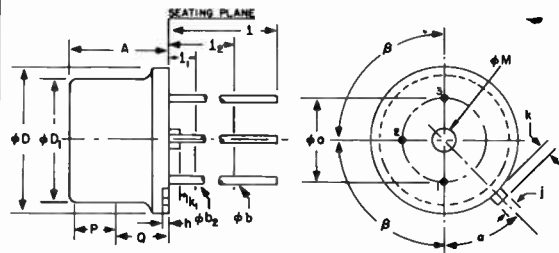

TO 43

SYMBOL	INCHES		MILLIMETERS		NOTES
	MIN.	MAX.	MIN.	MAX.	
ϕa	.190	.210	4.83	5.33	
A	.200	.260	5.08	6.60	
ϕb	.016	.021	.406	.533	2
ϕb_2	.016	.019	.406	.483	2
ϕD	.290	.370	7.37	9.40	
ϕD_1	.290	.335	7.37	8.51	
h	.009	.125	.229	3.18	
j	.028	.034	.711	.864	
k	.029		.737		3
k ₁	.017	.075	.432	1.91	
l	1.500		38.10		2
l ₁		.050		1.27	2
l ₂	.250		6.35		2
ϕM	.050	.100	1.27	2.54	
P	.100		2.54		1
Q					4
α	45° NOMINAL				
β	90° NOMINAL				

NOTES:

- THIS ZONE CONTROLLED FOR AUTOMATIC HANDLING. THE VARIATION IN ACTUAL DIAMETER WITHIN THIS ZONE SHALL NOT EXCEED .010" (.254 MM).
- (THREE LEADS) ϕb_2 APPLIES BETWEEN l₁ AND l₂. ϕb APPLIES BETWEEN l₂ AND 1.5" (38.10 MM) FROM SEATING PLANE. DIAMETER IS UNCONTROLLED IN l₁ AND BEYOND 1.5" (38.10 MM) FROM SEATING PLANE.
- MEASURED FROM MAXIMUM DIAMETER OF THE ACTUAL DEVICE.
- DETAILS OF OUTLINE IN THIS ZONE OPTIONAL.
THIS OUTLINE DOES NOT MEET THE MINIMUM CRITERIA ESTABLISHED BY JS-10 FOR REGISTRATION.

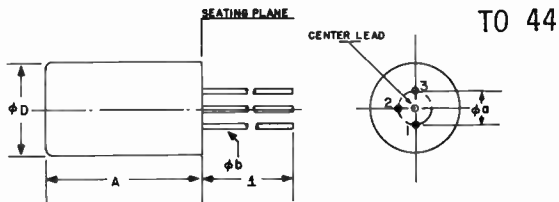

SYMBOL	INCHES		MILLIMETERS		NOTES
	MIN.	MAX.	MIN.	MAX.	
ϕa	.064	.080	1.63	2.03	
A		.405		10.29	
ϕb	.016	.019	.406	.483	1
ϕD		.240		6.10	
1	1.500		38.10		

NOTES:

1. FOUR LEADS.

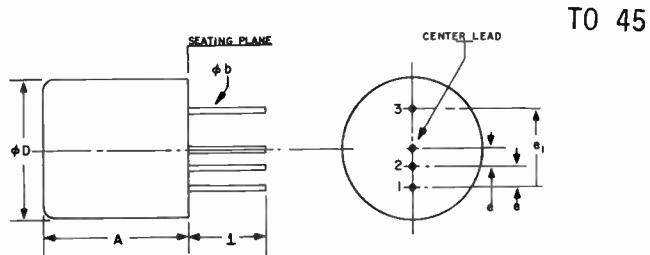

SYMBOL	INCHES		MILLIMETERS		NOTES
	MIN.	MAX.	MIN.	MAX.	
ϕa	.185	.199	4.70	5.05	
A		.375		9.53	
ϕb	.016	.019	.406	.483	1
ϕD		.360		9.14	
e	.041	.055	1.04	1.40	
e_1	.185	.199	4.70	5.05	
1	.172	.202	4.37	5.13	1

NOTES:

1. FOUR LEADS.

THIS OUTLINE DOES NOT MEET THE MINIMUM CRITERIA ESTABLISHED BY JS-10 FOR REGISTRATION.

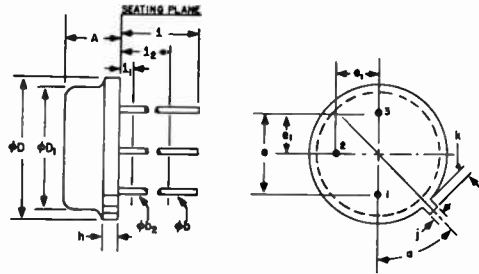

TO 46

SYMBOL	INCHES		MILLIMETERS		NOTES
	MIN.	MAX.	MIN.	MAX.	
A	.065	.085	1.65	2.16	
phi b	.016	.021	.406	.533	1
phi b_2	.012	.019	.305	.483	1
phi D	.209	.230	5.31	5.84	
phi D_1	.178	.195	4.52	4.95	
e	.100 T.P.		2.54 T.P.		2
e_1	.050 T.P.		1.27 T.P.		2
h		.040		1.02	
j	.036	.046	.914	1.17	
k	.028	.048	.711	1.22	4
l	.500		12.70		1
l_1		.050		1.27	1
l_2	.250		6.35		1
a	45° T.P.		45° T.P.		3, 5

NOTES:

- (THREE LEADS) ϕb_2 APPLIES BETWEEN l_1 AND l_2 . ϕb APPLIES BETWEEN l_2 AND .5" (12.70 MM) FROM SEATING PLANE. DIAMETER IS UNCONTROLLED IN l_1 AND BEYOND .5" (12.70 MM) FROM SEATING PLANE.
- MAXIMUM DIAMETER LEADS AT A GAGING PLANE .054" (1.37 MM) + .001" (.025 MM) - .000" (.000 MM) BELOW SEATING PLANE TO BE WITHIN .007" (.178 MM) OF THEIR TRUE POSITION RELATIVE TO MAXIMUM-WIDTH TAB AND TO THE MAXIMUM .230" (5.84 MM) DIAMETER MEASURED WITH A SUITABLE GAGE. WHEN GAGE IS NOT USED, MEASUREMENT WILL BE MADE AT SEATING PLANE.
- INDEX TAB FOR VISUAL ORIENTATION ONLY.
- MEASURED FROM MAXIMUM DIAMETER OF THE ACTUAL DEVICE.
- TAB CENTERLINE.

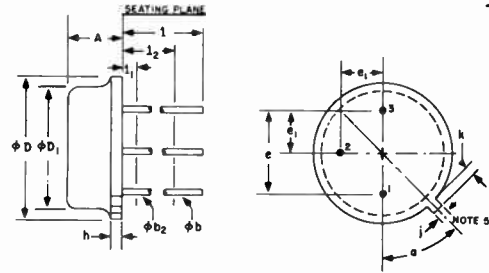

TO 47

SYMBOL	INCHES		MILLIMETERS		NOTES
	MIN.	MAX.	MIN.	MAX.	
A	.065	.085	1.65	2.16	
phi b	.016	.021	.406	.533	1
phi b_2	.012	.019	.305	.483	1
phi D	.240	.270	6.10	6.86	
phi D_1	.220	.240	5.59	6.10	
e	.141 T.P.		3.58 T.P.		2
e_1	.071 T.P.		1.80 T.P.		2
h		.040		1.02	
j	.015	.025	.381	.635	
k	.015	.025	.381	.635	4
l	.500		12.70		1
l_1		.050		1.27	1
l_2	.250		6.35		1
a	45° T.P.		45° T.P.		3

NOTES:

- (THREE LEADS) ϕb_2 APPLIES BETWEEN l_1 AND l_2 . ϕb APPLIES BETWEEN l_2 AND .5" (12.70 MM) FROM SEATING PLANE. DIAMETER IS UNCONTROLLED IN l_1 AND BEYOND .5" (12.70 MM) FROM SEATING PLANE.
- MAXIMUM DIAMETER LEADS AT A GAGING PLANE .054" (1.37 MM) + .001" (.025 MM) - .000" (.000 MM) BELOW THE SEATING PLANE TO BE WITHIN .007" (.178 MM) OF THEIR TRUE POSITION RELATIVE TO MAXIMUM-WIDTH TAB AND TO THE MAXIMUM .270" (6.86 MM) DIAMETER MEASURED WITH A SUITABLE GAGE. WHEN A GAGE IS NOT USED, MEASUREMENT WILL BE MADE AT SEATING PLANE.
- INDEX TAB FOR VISUAL ORIENTATION ONLY.
- MEASURED FROM MAXIMUM DIAMETER OF THE ACTUAL DEVICE.
- TAB CENTERLINE.

TO 48

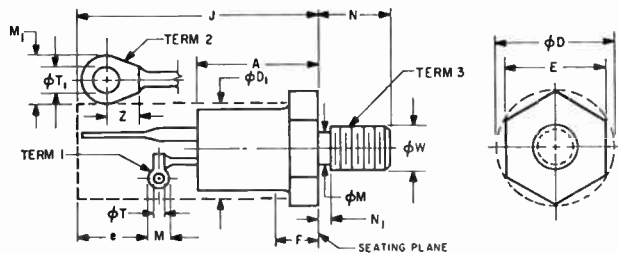

MILLIMETER DIMENSIONS ARE DERIVED FROM ORIGINAL INCH DIMENSIONS

SYMBOL	INCHES		MILLIMETERS		NOTES
	MIN.	MAX.	MIN.	MAX.	
A	.330	.505	8.4	12.8	-
ϕD	-	.650	-	16.51	-
ϕD_1	-	.544	-	13.81	5
e	.125	-	3.18	-	4
E	.544	.562	13.82	14.27	-
F	.113	.200	2.88	5.08	3
J	-	1.193	-	30.30	5
ϕM	.220	.249	5.59	6.32	6
M	.115	.140	2.93	3.55	1
M_1	.210	.300	5.34	7.62	1
N	.422	.453	10.72	11.50	-
N_1	-	.090	-	2.28	6
ϕT	.060	.075	1.53	1.90	-
ϕT_1	.125	.165	3.18	4.19	-
ϕW	.2225	.2268	5.652	5.760	2
Z	.120	-	3.05	-	7

NOTES:

1. CONTOUR & ANGULAR ORIENTATION OF THESE TERMINALS IS OPTIONAL.
2. PITCH DIAMETER OF 1/4-28 UNF-2A (COATED) THREADS (ASA B1.1-1960).
3. A CHAMFER OR UNDERCUT ON ONE OR BOTH ENDS OF HEXAGONAL PORTION IS OPTIONAL.
4. MINIMUM DIFFERENCE IN TERMINAL LENGTHS TO ESTABLISH DATUM LINE FOR NUMBERING TERMINALS.
5. THE DEVICE WITH EXCEPTION OF THE HEXAGON AND THREAD LIES WITHIN THE CYLINDER DEFINED BY ϕD_1 AND LENGTH J.
6. LENGTH OF INCOMPLETE OR UNDERCUT THREAD OF ϕM .
7. MINIMUM FLAT.

TO 49

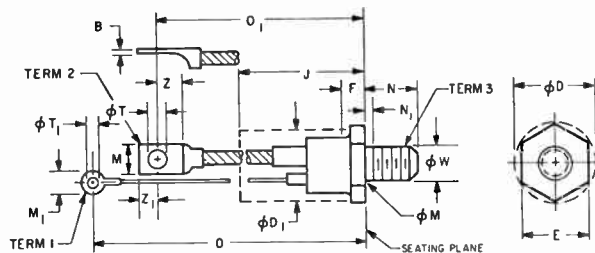

MILLIMETER DIMENSIONS ARE DERIVED FROM ORIGINAL INCH DIMENSIONS

SYMBOL	INCHES		MILLIMETERS		NOTES
	MIN.	MAX.	MIN.	MAX.	
B	.055	.110	1.40	2.79	-
ϕD	-	1.227	-	31.16	-
ϕD_1	-	1.031	-	26.18	1
E	1.031	1.063	26.19	27.00	-
F	.170	.500	4.4	12.7	5
J	-	2.500	-	63.50	1, 7
M	.437	.650	11.1	16.5	2
M_1	.215	.300	5.47	7.62	2
ϕM	.425	.499	10.80	12.67	3
N	.797	.827	20.25	21.00	-
N_1	-	.125	-	3.17	3
O	6.850	7.500	174.0	190.5	-
O_1	5.775	6.265	146.7	159.1	-
ϕT	.250	.310	6.35	7.87	-
ϕT_1	.140	.150	3.56	3.81	-
ϕW	.4619	.4675	11.733	11.874	4
Z	.250	-	6.35	-	6
Z_1	-	.325	-	8.25	-

NOTES:

1. THE DEVICE WITH THE EXCEPTION OF THE HEXAGON, THREAD, AND FLEXIBLE LEAD EXTENSIONS LIES WITHIN THE CYLINDER DEFINED BY ϕD_1 AND LENGTH J.
2. ANGULAR ORIENTATION OF THESE TERMINALS WITH RESPECT TO HEXAGONAL PORTION IS UNDEFINED. SQUARE OR RADIUS ON END OF TERMINALS IS OPTIONAL.
3. LENGTH OF INCOMPLETE OR UNDERCUT THREADS OF ϕM .
4. PITCH DIAMETER OF 1/2-20 UNF-2A (COATED) THREADS (ASA B1.1-1960).
5. A CHAMFER (OR UNDERCUT) ON ONE OR BOTH ENDS OF HEXAGONAL PORTION IS OPTIONAL.
6. MINIMUM FLAT.
7. SEATED HEIGHT WITH LEAD BENT AT RIGHT ANGLES.

TO 50

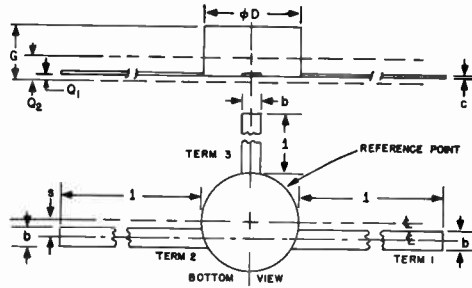

SYMBOL	INCHES		MILLIMETERS		NOTES
	MIN.	MAX.	MIN.	MAX.	
b	.015	.028	.381	.711	
c	.003	.005	.076	.127	
ϕD	.180	.215	4.57	5.46	2
G	.040	.060	1.02	1.52	
1	.250		6.35		
Q_1		.010		.254	1
Q_2		.025		.635	1
s	.015	.035	.381	.889	1

NOTES:

- LEADS SHALL EMERGE FROM THE ϕD DIMENSION WITHIN THE LIMITS INDICATED BY THE s, Q_1 AND Q_2 DIMENSIONS.
- MINIMUM AND MAXIMUM DIMENSIONS BOTH APPLY TO THE MAJOR (LARGEST) DIAMETER ONLY.

TO 51

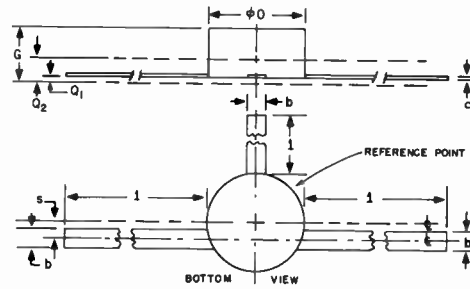

SYMBOL	INCHES		MILLIMETERS		NOTES
	MIN.	MAX.	MIN.	MAX.	
b	.015	.028	.381	.711	
c	.003	.005	.076	.127	
ϕD	.140	.165	3.56	4.19	2
G	.040	.060	1.02	1.52	
1	.250		6.35		
Q_1		.010		.254	1
Q_2		.025		.635	1
s	.015	.035	.381	.889	1

NOTES:

- LEADS SHALL EMERGE FROM THE ϕD DIMENSION WITHIN THE LIMITS INDICATED BY THE s, Q_1 , AND Q_2 DIMENSIONS.
- MINIMUM AND MAXIMUM DIMENSIONS BOTH APPLY TO THE MAJOR (LARGEST) DIAMETER ONLY.

TO 52

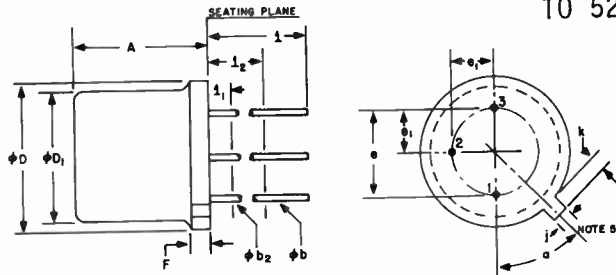

SYMBOL	INCHES		MILLIMETERS		NOTES
	MIN.	MAX.	MIN.	MAX.	
A	.115	.150	2.92	3.81	
phi b		.021		.533	1
phi b_2	.016	.019	.406	.483	1
phi D	.209	.230	5.31	5.84	
phi D_1	.178	.195	4.52	4.95	
e	.100 T.P.		2.54 T.P.		2
e_1	.050 T.P.		1.27 T.P.		
F		.030		.762	
j	.036	.046	.914	1.17	
k	.028	.048	.711	1.22	
l	.500		12.70		3
l_1		.050		1.27	1
l_2	.250		6.35		
a		45° T.P.			

NOTES:

- (THREE LEADS) ϕb_2 APPLIES BETWEEN l_1 AND l_2 . ϕb APPLIES BETWEEN l_2 AND .5" (12.70 MM) FROM SEATING PLANE. DIAMETER IS UNCONTROLLED IN l_1 AND BEYOND .5" (12.70 MM) FROM SEATING PLANE.
- LEADS HAVING MAXIMUM DIAMETER .019" (.483 MM) MEASURED IN GAGING PLANE .054" (1.37 MM) + .001" (.025 MM) - .000" (.000 MM) BELOW THE SEATING PLANE OF THE DEVICE SHALL BE WITHIN .007" (.178 MM) OF THEIR TRUE POSITIONS RELATIVE TO A MAXIMUM-WIDTH TAB.
- MEASURED FROM MAXIMUM DIAMETER OF THE ACTUAL DEVICE.
- THE DEVICE MAY BE MEASURED BY DIRECT METHODS OR BY THE GAGE AND GAGING PROCEDURE DESCRIBED ON GAGE DRAWING GS-2.
- TAB CENTERLINE.

TO 53

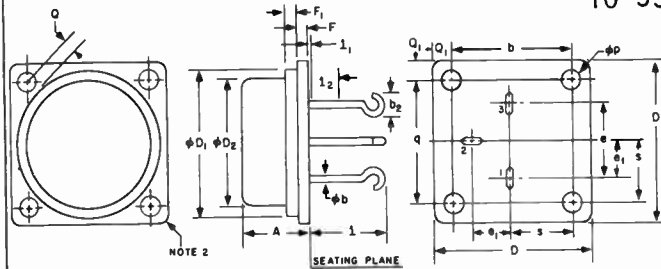

SYMBOL	INCHES		MILLIMETERS		NOTES
	MIN.	MAX.	MIN.	MAX.	
A	.305	.355	7.75	9.02	
phi b	.035	.045	.889	1.14	7
b_2	.130	.150	3.30	3.81	7
D	.850	.870	21.59	22.10	
phi D_1	.765	.785	19.43	19.94	
phi D_2	.670	.680	17.02	17.27	
e	.400 T.P.		10.16 T.P.		3, 4
e_1	.200 T.P.		5.08 T.P.		3, 4
F	.040	.055	1.02	1.40	
F_1	.030	.065	.762	1.65	
l	.370	.420	9.40	10.67	
l_1	.125		.787		1, 7
l_2	.125		3.18		5
phi p	.096	.106	2.44	2.69	8
q	.670	.690	17.02	17.53	
Q	.075		1.91		6
Q_1	.075	.105	1.91	2.67	
s	.340 T.P.		8.64 T.P.		3, 4

NOTES:

- LEAD DIAMETER NOT CONTROLLED IN THIS AREA.
- RADIUS AT CORNERS OF MOUNTING FLANGE OPTIONAL.
- ANGULAR ORIENTATION OF TERMINAL ENDS AS SHOWN $\pm 15^\circ$.
- LEADS HAVING MAXIMUM DIAMETER .045" (1.14 MM) MEASURED IN GAGE PLANE .031" (.787 MM) + .001" (.025 MM) - .000" (.000 MM) BELOW THE SEATING PLANE OF THE DEVICE SHALL BE WITHIN .010" (.254 MM) OF THEIR TRUE POSITION RELATIVE TO MINIMUM DIAMETER .096" (2.44 MM) HOLES IN THE MOUNTING FLANGE.
- THE LEADS SHALL BE ESSENTIALLY STRAIGHT WITHIN THIS ZONE.
- CLEARANCE FROM HOLE CENTERS TO ϕD_1 FOR MOUNTING FASTENERS.
- THREE LEADS.
- FOUR HOLES.

TO 56

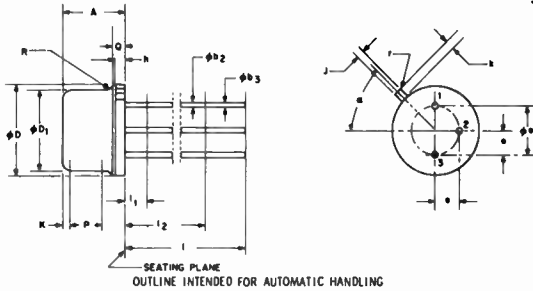

SEATING PLANE
OUTLINE INTENDED FOR AUTOMATIC HANDLING

SYMBOL	INCHES		MILLIMETERS		NOTES
	MIN.	MAX.	MIN.	MAX.	
A	0.170	0.210	4.32	5.33	
a		0.100		2.54	4
b ₂	0.016	0.019	0.406	0.483	2
b ₃		0.021		0.53	2
O	0.209	0.230	5.31	5.84	6
D ₁	0.182	0.192	4.62	4.88	7
e		0.050		1.27	
h	0.005	0.015	0.13	0.38	8
j	0.036	0.046	0.91	1.17	
K	0.010		0.25		
k	0.030	0.046	0.76	1.17	3
l	0.500	0.625	12.7	15.9	2
l ₁		0.020		0.51	2
l ₂	0.250		6.35		2
P	0.125		3.18		1
Q		0.023		0.58	
R		0.010		0.25	
r		0.007		0.18	
a		45°		45°	5

NOTES:

- THIS ZONE IS CONTROLLED FOR AUTOMATIC HANDLING. THE VARIATION IN ACTUAL DIAMETER WITHIN THE ZONE SHALL NOT EXCEED 0.019" (0.25 MM).
- (3 LEADS) ϕb_2 APPLIES BETWEEN l_1 AND l_2 . ϕb_3 APPLIES BETWEEN l_2 AND 0.5" FROM SEATING PLANE. DIAMETER IS UNCONTROLLED IN l_1 AND BEYOND 0.5" FROM SEATING PLANE.
- MEASURED FROM MAXIMUM DIAMETER OF ACTUAL DEVICE.
- LEADS HAVING MAXIMUM DIAMETER (0.019", 0.438 MM), MEASURED IN GAGING PLANE 0.054" \pm 0.001" \pm 0.000" (1.372 MM \pm 0.025 MM - 0.000 MM) BELOW THE SEATING PLANE OF THE DEVICE SHALL BE WITHIN 0.007" (0.178 MM) OF THEIR TRUE LOCATIONS RELATIVE TO MAXIMUM WIDTH TAB.
- TAB CENTERLINE.
- CONCENTRIC TO ϕa WITHIN 0.006" TOTAL INDICATOR READING. CAP FLANGE SHALL NEVER EXTEND BEYOND HEADER PERIPHERY. 0.005" MAX R10P9 OR WELD FLASH.
- CONCENTRIC TO ϕa WITHIN 0.006" TOTAL INDICATOR READING.
- APPLIES TO THICKNESS OF TAB.

TO 57

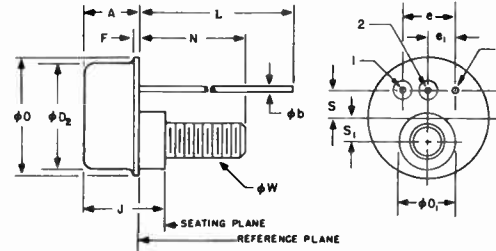

SEATING PLANE
REFERENCE PLANE

SYMBOL	INCHES		MILLIMETERS		NOTES
	MIN.	MAX.	MIN.	MAX.	
A	.195	.215	4.96	5.46	
Ab	.016	.019	.407	.482	1, 4
Ad	.440	.460	11.2	11.6	
Ad ₁	.220	.230	5.59	5.84	
Ad ₂	.400	.420	10.2	10.7	
e	.200 T.P.			5.08 T.P.	4
e ₁	.100 T.P.			2.54 T.P.	4
F		.030		.762	
J	.278	.318	2.11	2.61	
L	1.485	1.525	37.72	38.73	1
N	.380	.410	9.66	10.4	
S	.100 T.P.		2.54 T.P.		4
S ₁	.078 T.P.		1.98 T.P.		4
W	.1141	.1177	2.895	2.975	2, 3

NOTES:

- (THREE LEADS), THE SPECIFIED LEAD DIAMETER APPLIES TO THE ZONE BETWEEN .050" (1.27 MM) AND .250" (6.35 MM) FROM THE REFERENCE PLANE. BETWEEN .250" (6.35 MM) AND END OF LEAD, A MAXIMUM OF .021" (.533 MM) IS HELD. OUTSIDE OF THE ZONES THE LEAD DIAMETER IS NOT CONTROLLED.
- 6-32NC-2A. MAXIMUM PITCH DIAMETER OF PLATED THREADS SHALL BE BASIC PITCH DIAMETER (.1177", 2.98 MM). REFERENCE (SCREW THREAD STANDARDS FOR FEDERAL SERVICES 1957) HANDBOOK H28-PART 1.
- COMPLETE THREADS SHALL EXTEND TO WITHIN THREE THREADS OF THE SEATING PLANE AND SHALL REMAIN WITHIN TOLERANCES TO WITHIN TWO THREADS OF TIP OF STUD.
- MAXIMUM (.019", .483 MM) DIAMETER LEADS AND MAXIMUM (.230", 5.84 MM) STUD SHOULDER TO BE WITHIN .007" (.178 MM) RADIUS OF TRUE LOCATION RELATIVE TO THE (.460", 11.68 MM) DIAMETER FLANGE AT A GAUGING PLANE .054" (1.37 MM) \pm .001" (.025 MM), \pm .000" (.000 MM), FROM THE REFERENCE PLANE.

TO 60

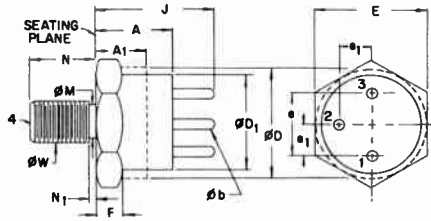

SYMBOL	INCHES		MILLIMETERS		NOTES
	MIN.	MAX.	MIN.	MAX.	
A	.215	.320	5.46	8.13	
A ₁		.165		4.19	2
∅b	.030	.046	.762	1.17	
∅D	.360	.437	9.14	11.10	2
∅D ₁	.320	.360	8.13	9.14	
E	.424	.437	10.77	11.10	
e	.185	.215	4.70	5.46	
e ₁	.090	.110	2.29	2.79	
F	.090	.135	2.29	3.43	1
J	.355	.480	9.02	12.19	
∅M	.163	.189	4.14	4.80	
N	.375	.455	9.53	11.56	
N ₁		.078		1.98	
∅W	.1658	.1697	4.212	4.310	3

NOTES:

1. DIMENSION DOES NOT INCLUDE SEALING FLANGES.
2. PACKAGE CONTOUR OPTIONAL WITHIN DIMENSIONS SPECIFIED.
3. PITCH DIAMETER - THREAD 10-32 UNF-2A (COATED). REFERENCE (SCREW THREAD STANDARDS FOR FEDERAL SERVICES - HANDBOOK H-28).

TO 61

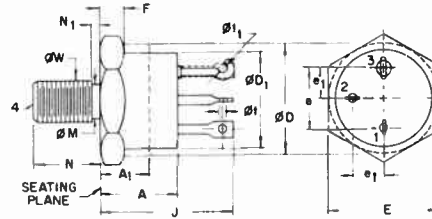

SYMBOL	INCHES		MILLIMETERS		NOTES
	MIN.	MAX.	MIN.	MAX.	
A	.325	.460	8.26	11.68	
A ₁		.270		6.86	2
∅D	.610	.687	15.49	17.45	2
∅D ₁	.570	.610	14.48	15.49	
E	.667	.687	16.94	17.45	
e	.340	.415	8.64	10.54	5
e ₁	.170	.213	4.32	5.41	5
F	.090	.150	2.29	3.81	1
J	.640	.875	16.26	22.23	
∅M	.220	.249	5.59	6.32	
N	.422	.455	10.72	11.56	
N ₁		.090		2.29	
∅t	.047	.072	1.19	1.83	
∅t ₁	.046	.077	1.17	1.96	4
∅W	.2225	.2268	5.651	5.761	3

NOTES:

1. DIMENSION DOES NOT INCLUDE SEALING FLANGES.
2. PACKAGE CONTOUR OPTIONAL WITHIN DIMENSIONS SPECIFIED.
3. PITCH DIAMETER - THREAD 1/4-28 UNF-2A (COATED). REFERENCE (SCREW THREAD STANDARDS FOR FEDERAL SERVICES - HANDBOOK H-28).
4. THIS TERMINAL CAN BE FLATTENED AND PIERCED OR HOOK TYPE.
5. POSITION OF LEADS IN RELATION TO THE HEXAGON IS NOT CONTROLLED.

TO 62

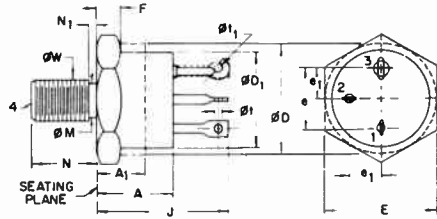

SYMBOL	INCHES		MILLIMETERS		NOTES
	MIN.	MAX.	MIN.	MAX.	
A	.360	.434	9.14	11.02	
A ₁	.270		6.86		2
ØD	.430	.562	10.92	14.27	2
ØD ₁	.410	.430	10.41	10.92	
E	.544	.562	13.82	14.27	
e	.235	.265	5.97	6.73	5
e ₁	.115	.135	2.92	3.43	5
F	.090	.150	2.29	3.81	1
J	.687	.737	17.45	18.72	
ØM	.163	.189	4.14	4.80	
N	.403	.498	10.24	12.65	
N ₁		.078		1.98	
Øt	.042	.071	1.07	1.80	
Øt ₁	.046	.069	1.17	1.75	4
ØW	.1658	.1697	4.211	4.310	3

NOTES:

1. DIMENSION DOES NOT INCLUDE SEALING FLANGES.
2. PACKAGE CONTOUR OPTIONAL WITHIN DIMENSIONS SPECIFIED.
3. PITCH DIAMETER - THREAD 10-32 UNF-2A (COATED). REFERENCE (SCREW THREAD STANDARDS FOR FEDERAL SERVICES - HANDBOOK H-28).
4. THIS TERMINAL CAN BE FLATTENED AND PIERCED OR HOOK TYPE.
5. POSITION OF LEADS IN RELATION TO THE HEXAGON IS NOT CONTROLLED.

TO 63

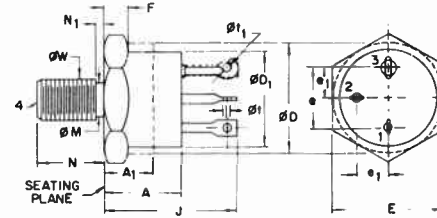

SYMBOL	INCHES		MILLIMETERS		NOTES
	MIN.	MAX.	MIN.	MAX.	
A	.480	.535	12.19	13.59	
A ₁		.300		7.62	2
ØD	.775	.875	19.69	22.23	2
ØD ₁	.745	.775	18.92	19.69	
E	.855	.875	21.72	22.23	
e	.485	.515	12.32	13.08	5
e ₁	.240	.260	6.10	6.60	5
F	.090	.167	2.29	4.24	1
J	.937	1.030	23.80	26.16	
ØM	.278	.312	7.06	7.92	
N	.460	.495	11.68	12.57	
N ₁		.105		Ø.67	
Øt	.060	.105	1.52	2.67	
Øt ₁	.060	.105	1.52	2.67	4
ØW	.2806	.2854	7.127	7.249	3

NOTES:

1. DIMENSION DOES NOT INCLUDE SEALING FLANGES.
2. PACKAGE CONTOUR OPTIONAL WITHIN DIMENSIONS SPECIFIED.
3. PITCH DIAMETER - THREAD 5/16-24 UNF-2A (COATED). REFERENCE (SCREW THREAD STANDARDS FOR FEDERAL SERVICES - HANDBOOK H-28).
4. THIS TERMINAL CAN BE FLATTENED AND PIERCED OR HOOK TYPE.
5. POSITION OF LEADS IN RELATION TO THE HEXAGON IS NOT CONTROLLED.

TO 64

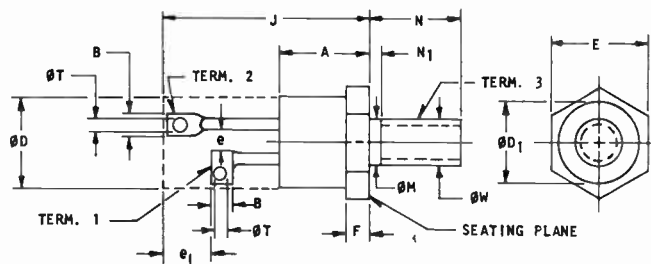

SYMBOL	INCHES		MILLIMETERS		NOTES
	MIN.	MAX.	MIN.	MAX.	
A	.300	.400	7.62	10.16	
B	.080	.136	2.03	3.45	1
ØD		.424		10.77	2
ØD1	.400		10.16		3, 4
E	.424	.437	10.77	11.10	
e	.013		.330		7
e1	.060		1.52		5
F	.060	.175	1.52	4.45	4
J	.700	.955	17.78	21.72	2
ØM	.163	.189	4.14	4.80	
N	.400	.453	10.16	11.51	
N1		.078		1.98	
ØT	.040	.075	1.02	1.91	
ØW	.1658	.1697	4.212	4.310	6

NOTES:

1. CONTOUR AND ORIENTATION OF FIXED TERMINAL LUGS ARE OPTIONAL.
2. THE OUTLINE CONTOUR (WITH EXCEPTION OF HEXAGON) IS OPTIONAL WITHIN ZONE DEFINED BY ØD AND J.
3. MINIMUM DIAMETER OF SEATING PLANE.
4. A CHAMFER (OR UNDERCUT) ON ONE OR BOTH ENDS OF HEXAGONAL PORTION IS OPTIONAL.
5. MINIMUM DIFFERENCE IN TERMINAL LENGTHS TO ESTABLISH DATUM LINE FOR NUMBERING TERMINALS.
6. PITCH DIAMETER - THREAD 10-32 NF-2A (COATED). REFERENCE (SCREW THREAD STANDARDS FOR FEDERAL SERVICES 1957) HANDBOOK 1957 H28.
7. MINIMUM SPACING BETWEEN TERMINALS.

TO 65

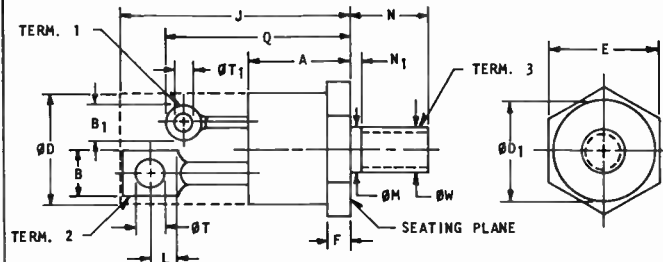

SYMBOL	INCHES		MILLIMETERS		NOTES
	MIN.	MAX.	MIN.	MAX.	
A	.300	.565	7.62	14.35	
B	.200	.300	5.08	7.62	1
B1	.100	.140	2.54	3.56	1
ØD		.667		16.94	2
ØD1	.600		15.24		3, 4
E	.667	.687	16.94	17.45	
F	.113	.200	2.87	5.08	4
J	1.000	1.250	25.40	31.75	2
L	.120		3.05		6
ØM	.220	.269	5.59	6.32	
N	.422	.453	10.72	11.51	
N1		.090		2.29	
Q	.700	.885	17.78	22.48	
ØT	.125	.165	3.18	4.19	
ØT1	.055	.075	1.40	1.91	
ØW	.2225	.2268	5.652	5.760	5

NOTES:

1. CONTOUR AND ORIENTATION OF FIXED TERMINAL LUGS ARE OPTIONAL.
2. THE OUTLINE CONTOUR (WITH EXCEPTION OF HEXAGON) IS OPTIONAL WITHIN ZONE DEFINED BY ØD AND J.
3. MINIMUM DIAMETER OF SEATING PLANE.
4. A CHAMFER (OR UNDERCUT) ON ONE OR BOTH ENDS OF HEXAGONAL PORTION IS OPTIONAL.
5. PITCH DIAMETER - THREAD 1/4-28 UNF-2A (COATED). REFERENCE (SCREW THREAD STANDARDS FOR FEDERAL SERVICES 1957) HANDBOOK 1957 H28.
6. MINIMUM FLAT.

TO 66

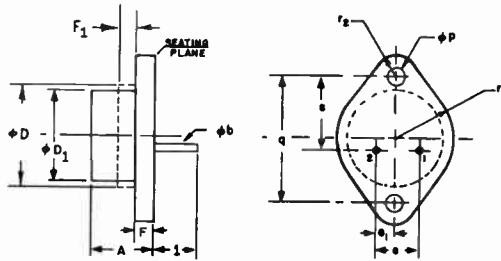

SYMBDL	INCHES		MILLIMETERS		NOTES
	MIN.	MAX.	MIN.	MAX.	
A	.250	.340	6.35	8.64	
ϕb	.028	.034	.711	.863	
ϕD		.620		15.75	
ϕD_1	.470	.500	11.94	12.70	
e	.190	.210	4.83	5.33	
e_1	.093	.107	2.36	2.72	
F	.050	.075	1.27	1.91	2
F_1		.050		1.27	1
l	.360		9.14		
ϕp	.142	.152	3.61	3.86	
q	.958	.962	24.33	24.43	
r_1		.350		8.89	
r_2		.145		3.68	
s	.570	.590	14.48	14.99	

NOTES:

1. THE OUTLINE CONTOUR IS OPTIONAL WITHIN ZONE DEFINED BY ϕD AND F_1 .
2. DIMENSION DOES NOT INCLUDE SEALING FLANGES.

TO 67

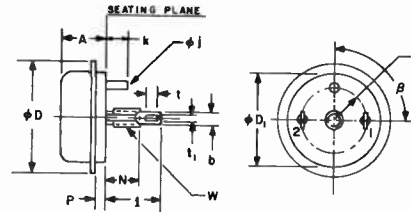

SYMBOL	INCHES		MILLIMETERS		NOTES
	MIN.	MAX.	MIN.	MAX.	
A	.275	.500	6.99	12.70	
b	.100	.185	2.54	4.70	
ϕD		1.250		31.75	
ϕD_1	.990	1.010	25.15	25.65	1
ϕj	.090	.140	2.29	3.56	4
k	.100	.312	2.54	7.92	4
l	.610	.710	15.49	18.03	
N	.375	.500	9.53	12.70	
P	.050		1.27		-
r	.335	.355	8.51	9.02	1
t	.120	.145	3.05	3.68	
t_1	.070	.120	1.78	3.05	
W	.1658	.1697	4.212	4.310	2, 3
β	85°	95°	85°	95°	1

NOTES:

1. MEASURED AT SEATING PLANE.
2. COMPLETE THREADS TO EXTEND TO WITHIN 3-1/2 THREADS OF SEATING PLANE.
3. PITCH DIAMETER DF 10-32 NF-2A (CDATED) THREADS. (ASA B1.1-1960)
4. MECHANICAL INDEX.

TO 68

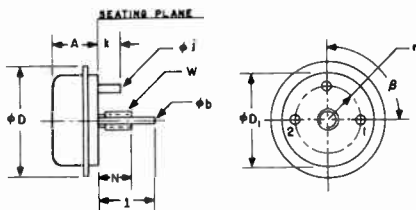

SYMBOL	INCHES		MILLIMETERS		NOTES
	MIN.	MAX.	MIN.	MAX.	
A	.275	.500	6.99	12.70	
ϕb	.040	.095	1.02	2.41	
∅D		1.250		31.75	
∅D ₁	.990		25.15		1
∅j	.090	.140	2.29	3.56	4
k	.100	.312	2.54	7.92	4
l	.610	.710	15.49	18.03	
N	.375	.500	9.53	12.70	
r	.335	.355	8.51	9.02	1
w	.1658	.1697	4.212	4.310	2, 3
β	85°	95°	85°	95°	1

NOTES:

1. MEASURED AT SEATING PLANE.
2. COMPLETE THREADS TO EXTEND TO WITHIN 3-1/2 THREADS OF SEATING PLANE.
3. PITCH DIAMETER OF 10-32 NF-2A (COATED) THREADS. (ASA B1.1-1960)
4. MECHANICAL INDEX.

TO 69

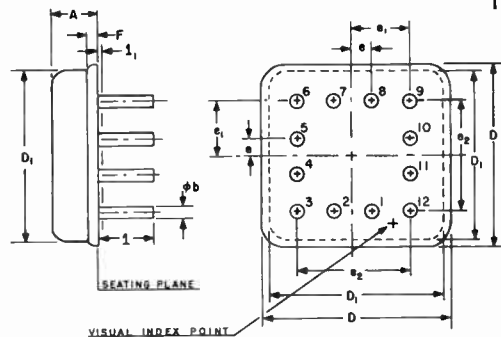

SYMBOL	INCHES		MILLIMETERS		NOTES
	MIN.	MAX.	MIN.	MAX.	
A	.075	.085	1.905	2.159	
ϕb	.016	.019	.406	.483	2
D	.295	.305	7.49	7.75	
D ₁	.275	.285	6.99	7.24	
e	.033 T.P.		.838 T.P.		1
e ₁	.098 T.P.		2.49 T.P.		1
e ₂	.195 T.P.		4.95 T.P.		1
F	.030	.050	.762	1.270	
l	.070		1.78		
l ₁		.025		.635	2

NOTES:

1. LEADS HAVING MAXIMUM DIAMETER .019" (.483 MM) MEASURED IN GAGING PLANE .025" (.635 MM) + .001" (.025 MM) - .000" (.000 MM) BELOW THE SEATING PLANE OF THE DEVICE SHALL BE WITHIN .007" (.178 MM) OF THEIR TRUE POSITIONS.
2. LEAD THICKNESS UNCONTROLLED IN THIS ZONE.

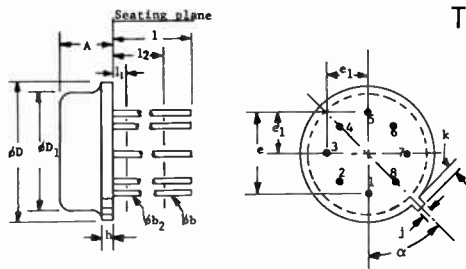

TO 70

SYMBOL	INCHES		MILLIMETERS		NOTES
	MIN.	MAX.	MIN.	MAX.	
A	.065	.085	1.65	2.16	
ϕb	.016	.021	.406	.533	2
ϕb_2	.016	.019	.406	.483	2
ϕD	.240	.270	6.10	6.86	
ϕD_1	.205	.240	5.21	6.10	
e	.141 T.P.		3.58 T.P.		4
e ₁	.071 T.P.		1.80 T.P.		4
h		.040		1.02	
j	.015	.025	.381	.635	
k	.015	.025	.381	.635	3
l	.500		12.70		2
l ₁		.050		1.27	2
l ₂	.250		6.35		2
α	45° T.P.		45° T.P.		4, 6

NOTES:

- (EIGHT LEADS). MAXIMUM NUMBER OF LEADS OMITTED IN THIS OUTLINE, "THREE" (3). THE NUMBER AND POSITION OF LEADS ACTUALLY PRESENT ARE INDICATED IN THE PRODUCT REGISTRATION. OUTLINE DESIGNATION DETERMINED BY THE LOCATION AND MINIMUM ANGULAR SPACING OF ANY TWO ADJACENT LEADS.
- (ALL LEADS) ϕb_2 APPLIES BETWEEN l_1 AND l_2 . ϕb APPLIES BETWEEN l_2 AND .500" (12.70 MM) FROM SEATING PLANE. DIAMETER IS UNCONTROLLED IN l_1 AND BEYOND .500" (12.70 MM) FROM SEATING PLANE.
- MEASURED FROM MAXIMUM DIAMETER OF THE PRODUCT.
- LEADS HAVING MAXIMUM DIAMETER .019" (.483 MM) MEASURED IN GAGING PLANE .054" (1.37 MM) + .001" (.025 MM) - .000" (.000 MM) BELOW THE SEATING PLANE OF THE PRODUCT SHALL BE WITHIN .007" (.178 MM) OF THEIR TRUE POSITION RELATIVE TO A MAXIMUM WIDTH TAB.
- THE PRODUCT MAY BE MEASURED BY DIRECT METHODS OR BY GAGE.
- TAB CENTERLINE.

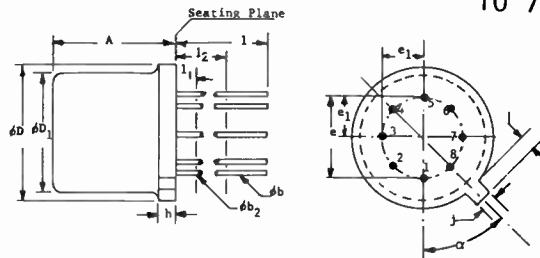

TO 71

SYMBOL	INCHES		MILLIMETERS		NOTES
	MIN.	MAX.	MIN.	MAX.	
A	.170	.210	4.32	5.33	
ϕb	.016	.021	.406	.533	2
ϕb_2	.016	.019	.406	.483	2
ϕD	.209	.230	5.31	5.84	
ϕD_1	.175	.195	4.45	4.95	
e	.100 T.P.		2.54 T.P.		4
e ₁	.050 T.P.		1.27 T.P.		4
h		.030		.762	
j	.036	.046	.914	1.17	
k	.028	.048	.711	1.22	3
l	.500		12.70		2
l ₁		.050		1.27	2
l ₂	.250		6.35		2
α	45° T.P.		45° T.P.		4, 6

NOTES:

- (EIGHT LEADS). MAXIMUM NUMBER OF LEADS OMITTED IN THIS OUTLINE, "THREE" (3). THE NUMBER AND POSITION OF LEADS ACTUALLY PRESENT ARE INDICATED IN THE PRODUCT REGISTRATION. OUTLINE DESIGNATION DETERMINED BY THE LOCATION AND MINIMUM ANGULAR SPACING OF ANY TWO ADJACENT LEADS.
- (ALL LEADS) ϕb_2 APPLIES BETWEEN l_1 AND l_2 . ϕb APPLIES BETWEEN l_2 AND .500" (12.70 MM) FROM SEATING PLANE. DIAMETER IS UNCONTROLLED IN l_1 AND BEYOND .500" (12.70 MM) FROM SEATING PLANE.
- MEASURED FROM MAXIMUM DIAMETER OF THE PRODUCT.
- LEADS HAVING MAXIMUM DIAMETER .019" (.483 MM) MEASURED IN GAGING PLANE .054" (1.37 MM) + .001" (.025 MM) - .000" (.000 MM) BELOW THE SEATING PLANE OF THE PRODUCT SHALL BE WITHIN .007" (.178 MM) OF THEIR TRUE POSITION RELATIVE TO A MAXIMUM WIDTH TAB.
- THE PRODUCT MAY BE MEASURED BY DIRECT METHODS OR BY GAGE.
- TAB CENTERLINE.

T0 72

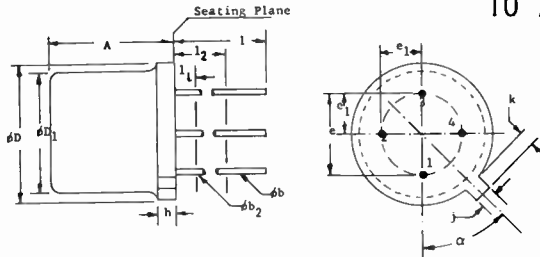

SYMBOL	INCHES		MILLIMETERS		NOTES
	MIN.	MAX.	MIN.	MAX.	
A	.170	.210	4.32	5.33	2
ϕb	.016	.021	.406	.533	2
ϕb_2	.016	.019	.406	.483	2
ϕD	.209	.230	5.31	5.84	
ϕD_1	.178	.195	4.52	4.95	
e	.100 T.P.		2.54 T.P.		4
e_1	.050 T.P.		1.27 T.P.		4
h		.030		.762	
j	.036	.046	.914	1.17	
k	.028	.048	.711	1.22	3
l	.500		12.70		2
l_1		.050		1.27	2
l_2	.250		6.35		2
a		45° T.P.		45° T.P.	4, 6

NOTES:

- (FOUR LEADS). MAXIMUM NUMBER OF LEADS OMITTED IN THIS OUTLINE, "NONE" (0). THE NUMBER AND POSITION OF LEADS ACTUALLY PRESENT ARE INDICATED IN THE PRODUCT REGISTRATION. OUTLINE DESIGNATION DETERMINED BY THE LOCATION AND MINIMUM ANGULAR OR LINEAR SPACING OF ANY TWO ADJACENT LEADS.
- (ALL LEADS) ϕb_2 APPLIES BETWEEN l_1 AND l_2 . ϕb APPLIES BETWEEN l_2 AND .500" (12.70 MM) FROM SEATING PLANE. DIAMETER IS UNCONTROLLED IN l_1 AND BEYOND .500" (12.70 MM) FROM SEATING PLANE.
- MEASURED FROM MAXIMUM DIAMETER OF THE PRODUCT.
- LEADS HAVING MAXIMUM DIAMETER .019" (.483 MM) MEASURED IN GAGING PLANE .054" (1.37 MM) + .001" (.025 MM) - .000" (.000 MM) BELOW THE SEATING PLANE OF THE PRODUCT SHALL BE WITHIN .007" (.178 MM) OF THEIR TRUE POSITION RELATIVE TO A MAXIMUM WIDTH TAB.
- THE PRODUCT MAY BE MEASURED BY DIRECT METHODS OR BY GAGE.
- TAB CENTERLINE.

T0 73

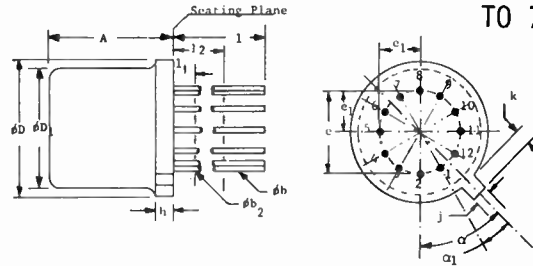

SYMBOL	INCHES		MILLIMETERS		NOTES
	MIN.	MAX.	MIN.	MAX.	
A	.240	.260	6.10	6.60	
ϕb	.016	.021	.406	.533	2
ϕb_2	.016	.019	.406	.483	2
ϕD	.335	.370	8.51	9.40	
ϕD_1	.305	.335	7.75	8.51	
e	.200 T.P.		5.08 T.P.		4
e_1	.100 T.P.		2.54 T.P.		4
h		.040		1.02	
j	.028	.034	.711	.864	
k	.029	.045	.737	1.14	3
l	.500		12.70		2
l_1		.050		1.27	2
l_2	.250		6.35		2
a		45° T.P.		45° T.P.	4, 6
a_1		15° T.P.		15° T.P.	4, 6

NOTES:

- (TWELVE LEADS). MAXIMUM NUMBER OF LEADS OMITTED IN THIS OUTLINE, "ONE" (1). THE NUMBER AND POSITION OF LEADS ACTUALLY PRESENT ARE INDICATED IN THE PRODUCT REGISTRATION. OUTLINE DESIGNATION DETERMINED BY THE LOCATION AND MINIMUM ANGULAR SPACING OF ANY TWO ADJACENT LEADS.
- (ALL LEADS) ϕb_2 APPLIES BETWEEN l_1 AND l_2 . ϕb APPLIES BETWEEN l_2 AND .500" (12.70 MM) FROM SEATING PLANE. DIAMETER IS UNCONTROLLED IN l_1 AND BEYOND .500" (12.70 MM) FROM SEATING PLANE.
- MEASURED FROM MAXIMUM DIAMETER OF THE PRODUCT.
- LEADS HAVING MAXIMUM DIAMETER .019" (.483 MM) MEASURED IN GAGING PLANE .054" (1.37 MM) + .001" (.025 MM) - .000" (.000 MM) BELOW THE SEATING PLANE OF THE PRODUCT SHALL BE WITHIN .007" (.178 MM) OF THEIR TRUE POSITION RELATIVE TO A MAXIMUM WIDTH TAB.
- THE PRODUCT MAY BE MEASURED BY DIRECT METHODS OR BY GAGE.
- TAB CENTERLINE.

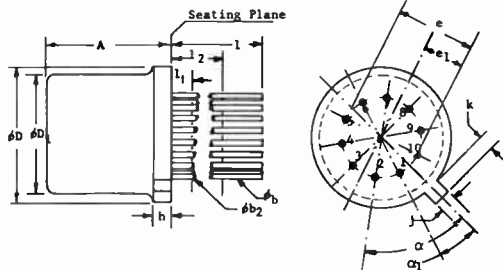

SYMBOL	INCHES		MILLIMETERS		NOTES
	MIN.	MAX.	MIN.	MAX.	
A	.240	.260	6.10	6.60	
ϕb	.016	.021	.406	.533	2
ϕb_2	.016	.019	.406	.483	2
ϕD	.335	.370	8.51	9.40	
ϕD_1	.305	.335	7.75	8.51	
e	.200 T.P.		5.08 T.P.		4
e ₁	.100 T.P.		2.54 T.P.		4
h	.040		1.02		
j	.028	.034	.711	.864	
k	.029	.045	.737	1.14	3
l	.500		12.70		2
l ₁	.050		1.27		2
l ₂	.250		6.35		2
α	54° T.P.		54° T.P.		4, 6
α_1	18° T.P.		18° T.P.		4, 6

NOTES:

- (TEN LEADS). MAXIMUM NUMBER OF LEADS OMITTED IN THIS OUTLINE, "ONE" (1). THE NUMBER AND POSITION OF LEADS ACTUALLY PRESENT ARE INDICATED IN THE PRODUCT REGISTRATION. OUTLINE DESIGNATION DETERMINED BY THE LOCATION AND MINIMUM ANGULAR SPACING OF ANY TWO ADJACENT LEADS.
- (ALL LEADS) ϕb_2 APPLIES BETWEEN l_1 AND l_2 . ϕb APPLIES BETWEEN l_2 AND .500" (12.70 MM) FROM SEATING PLANE. DIAMETER IS UNCONTROLLED IN l_1 AND BEYOND .500" (12.70 MM) FROM SEATING PLANE.
- MEASURED FROM MAXIMUM DIAMETER OF THE PRODUCT.
- LEADS HAVING MAXIMUM DIAMETER .019" (.483 MM) MEASURED IN GAGING PLANE .054" (1.37 MM) + .001" (.025 MM) - .000" (.000 MM) BELOW THE SEATING PLANE OF THE PRODUCT SHALL BE WITHIN .007" (.178 MM) OF THEIR TRUE POSITION RELATIVE TO A MAXIMUM WIDTH TAB.
- THE PRODUCT MAY BE MEASURED BY DIRECT METHODS OR BY GAGE.
- TAB CENTERLINE.

TO 74

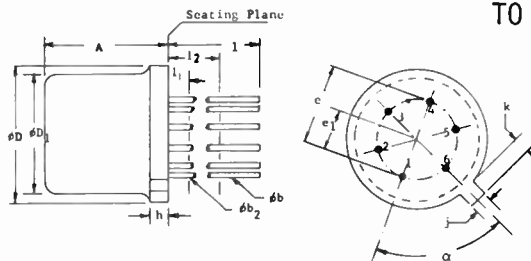

SYMBOL	INCHES		MILLIMETERS		NOTES
	MIN.	MAX.	MIN.	MAX.	
A	.240	.260	6.10	6.60	
ϕb	.016	.021	.406	.533	2
ϕb_2	.016	.019	.406	.483	2
ϕD	.335	.370	8.51	9.40	
ϕD_1	.305	.335	7.75	8.51	
e	.200 T.P.		5.08 T.P.		4
e ₁	.100 T.P.		2.54 T.P.		4
h	.040		1.02		
j	.028	.034	.711	.864	
k	.029	.045	.737	1.14	3
l	.500		12.70		2
l ₁	.050		1.27		2
l ₂	.250		6.35		2
α	60° T.P.		60° T.P.		4, 6

NOTES:

- (SIX LEADS). MAXIMUM NUMBER OF LEADS OMITTED IN THIS OUTLINE, "ONE" (1). THE NUMBER AND POSITION OF LEADS ACTUALLY PRESENT ARE INDICATED IN THE PRODUCT REGISTRATION. OUTLINE DESIGNATION DETERMINED BY THE LOCATION AND MINIMUM ANGULAR SPACING OF ANY TWO ADJACENT LEADS.
- (ALL LEADS) ϕb_2 APPLIES BETWEEN l_1 AND l_2 . ϕb APPLIES BETWEEN l_2 AND .500" (12.70 MM) FROM SEATING PLANE. DIAMETER IS UNCONTROLLED IN l_1 AND BEYOND .500" (12.70 MM) FROM SEATING PLANE.
- MEASURED FROM MAXIMUM DIAMETER OF THE PRODUCT.
- LEADS HAVING MAXIMUM DIAMETER .019" (.483 MM) MEASURED IN GAGING PLANE .054" (1.37 MM) + .001" (.025 MM) - .000" (.000 MM) BELOW THE SEATING PLANE OF THE PRODUCT SHALL BE WITHIN .007" (.178 MM) OF THEIR TRUE POSITION RELATIVE TO A MAXIMUM WIDTH TAB.
- THE PRODUCT MAY BE MEASURED BY DIRECT METHODS OR BY GAGE.
- TAB CENTERLINE.

TO 75

TO 76

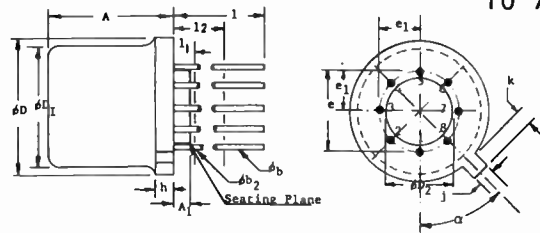

SYMBOL	INCHES		MILLIMETERS		NOTES
	MIN.	MAX.	MIN.	MAX.	
A	.240	.260	6.10	6.60	
A ₁	.010	.040	.254	1.02	
Øb	.016	.021	.406	.533	2
Øb ₂	.016	.019	.406	.483	2
ØD	.335	.370	8.51	9.40	
ØD ₁	.305	.335	7.75	8.51	
ØD ₂	.140	.160	3.56	4.06	
e	.200 T.P.		5.08 T.P.		4
e ₁	.100 T.P.		2.54 T.P.		4
h		.040		1.02	
j	.028	.034	.711	.864	
k	.029	.045	.737	1.14	3
l	.500		12.70		2
l ₁		.050		1.27	2
l ₂	.250		6.35		2
a	45° T.P.		45° T.P.		4, 6

NOTES:

- (EIGHT LEADS). MAXIMUM NUMBER OF LEADS OMITTED IN THIS OUTLINE, "THREE" (3). THE NUMBER AND POSITION OF LEADS ACTUALLY PRESENT ARE INDICATED IN THE PRODUCT REGISTRATION. OUTLINE DESIGNATION DETERMINED BY THE LOCATION AND MINIMUM ANGULAR SPACING OF ANY TWO ADJACENT LEADS.
- (ALL LEADS) Øb₂ APPLIES BETWEEN l₁ AND l₂. Øb APPLIES BETWEEN l₂ AND .500" (12.70 MM) FROM SEATING PLANE. DIAMETER IS UNCONTROLLED IN l₁ AND BEYOND .500" (12.70 MM) FROM SEATING PLANE.
- MEASURED FROM MAXIMUM DIAMETER OF THE PRODUCT.
- LEADS HAVING MAXIMUM DIAMETER .019" (.483 MM) MEASURED IN GAGING PLANE .054" (1.37 MM) + .001" (.025 MM) - .000" (.000 MM) BELOW THE SEATING PLANE OF THE PRODUCT SHALL BE WITHIN .007" (.178 MM) OF THEIR TRUE POSITION RELATIVE TO A MAXIMUM WIDTH TAB.
- THE PRODUCT MAY BE MEASURED BY DIRECT METHODS OR BY GAGE.
- TAB CENTERLINE.

TO 77

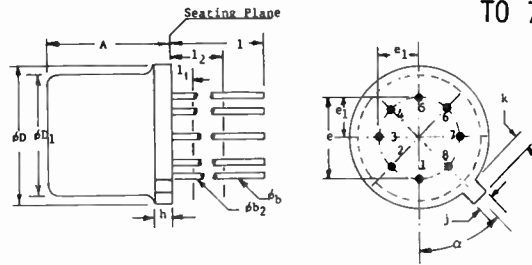

SYMBOL	INCHES		MILLIMETERS		NOTES
	MIN.	MAX.	MIN.	MAX.	
A	.240	.260	6.10	6.60	
Øb	.016	.021	.406	.533	2
Øb ₂	.016	.019	.406	.483	2
ØD	.335	.370	8.51	9.40	
ØD ₁	.305	.335	7.75	8.51	
e	.200 T.P.		5.08 T.P.		4
e ₁	.100 T.P.		2.54 T.P.		4
h		.040		1.02	
j	.028	.034	.711	.864	
k	.029	.045	.737	1.14	3
l	.500		12.70		2
l ₁		.050		1.27	2
l ₂	.250		6.35		2
a	45° T.P.		45° T.P.		4, 6

NOTES:

- (EIGHT LEADS). MAXIMUM NUMBER OF LEADS OMITTED IN THIS OUTLINE, "THREE" (3). THE NUMBER AND POSITION OF LEADS ACTUALLY PRESENT ARE INDICATED IN THE PRODUCT REGISTRATION. OUTLINE DESIGNATION DETERMINED BY THE LOCATION AND MINIMUM ANGULAR OR LINEAR SPACING OF ANY TWO ADJACENT LEADS.
- (ALL LEADS) Øb₂ APPLIES BETWEEN l₁ AND l₂. Øb APPLIES BETWEEN l₂ AND .500" (12.70 MM) FROM SEATING PLANE. DIAMETER IS UNCONTROLLED IN l₁ AND BEYOND .500" (12.70 MM) FROM SEATING PLANE.
- MEASURED FROM MAXIMUM DIAMETER OF THE PRODUCT.
- LEADS HAVING MAXIMUM DIAMETER .019" (.483 MM) MEASURED IN GAGING PLANE .054" (1.37 MM) + .001" (.025 MM) - .000" (.000 MM) BELOW THE SEATING PLANE OF THE PRODUCT SHALL BE WITHIN .007" (.178 MM) OF THEIR TRUE POSITION RELATIVE TO A MAXIMUM WIDTH TAB.
- THE PRODUCT MAY BE MEASURED BY DIRECT METHODS OR BY GAGE.
- TAB CENTERLINE.

TO 80

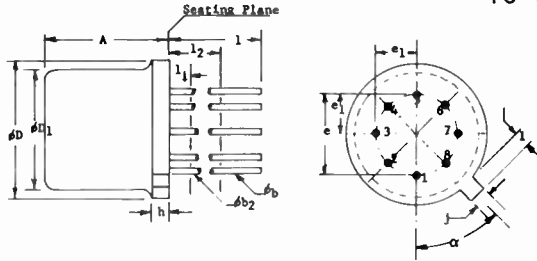

SYMBOL	INCHES		MILLIMETERS		NOTES
	MIN.	MAX.	MIN.	MAX.	
A	.085	.105	2.16	2.67	2
ϕb	.016	.021	.406	.533	2
ϕb_2	.016	.019	.406	.483	
ϕD	.335	.370	8.51	9.40	
ϕD_1	.305	.335	7.75	8.51	
e	.200 T.P.		5.08 T.P.		4
e ₁	.100 T.P.		2.54 T.P.		4
h		.040		1.02	
j	.028	.034	.711	.864	
k	.029	.045	.737	1.14	3
l	.500		12.70		2
l ₁		.050		1.27	2
l ₂	.250		6.35		2
α	45° T.P.		45° T.P.		4, 6

NOTES:

- (EIGHT LEADS). MAXIMUM NUMBER OF LEADS OMITTED IN THIS OUTLINE, "THREE" (3). THE NUMBER AND POSITION OF LEADS ACTUALLY PRESENT ARE INDICATED IN THE PRODUCT REGISTRATION. OUTLINE DESIGNATION DETERMINED BY THE LOCATION AND MINIMUM ANGULAR SPACING OF ANY TWO ADJACENT LEADS.
- (ALL LEADS) ϕb_2 APPLIES BETWEEN l₁ AND l₂. ϕb APPLIES BETWEEN l₂ AND .500" (12.70 MM) FROM SEATING PLANE. DIAMETER IS UNCONTROLLED IN l₁ AND BEYOND .500" (12.70 MM) FROM SEATING PLANE.
- MEASURED FROM MAXIMUM DIAMETER OF THE PRODUCT.
- LEADS HAVING MAXIMUM DIAMETER .019" (.483 MM) MEASURED IN GAGING PLANE .054" (1.37 MM) ± .001" (.025 MM) - .000" (.000 MM) BELOW THE SEATING PLANE OF THE PRODUCT SHALL BE WITHIN .007" (.178 MM) OF THEIR TRUE POSITION RELATIVE TO A MAXIMUM WIDTH TAB.
- THE PRODUCT MAY BE MEASURED BY DIRECT METHODS OR BY GAGE.
- TAB CENTERLINE.

TO 81

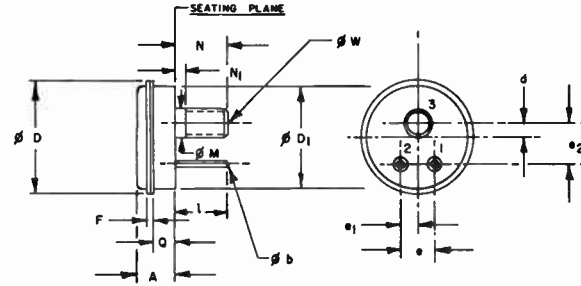

SYMBOL	INCHES		MILLIMETERS		NOTES
	MIN.	MAX.	MIN.	MAX.	
A	.300	.415	9.78	10.54	
ϕb	.055	.071	1.40	1.80	
ϕD	1.230	1.300	31.25	33.02	
ϕD_1	1.125	1.135	28.68	28.93	1
d	.151	.161	3.84	4.08	1
e	.370	.382	9.40	9.71	1
e ₁	.162	.192	4.63	4.87	1
e ₂	.435	.450	11.05	11.44	1
F		.065		1.65	
l	.500		12.70		
ϕM	.276	.312	7.07	7.92	
N	.545	.575	13.85	14.60	
N ₁		.107		2.71	3
Q	.227	.243	5.77	6.17	
ϕW	.2806	.2854	7.13	7.24	2

NOTES:

- MEASURED AT SEATING PLANE.
- PITCH DIAMETER OF 5/16-24 UNF-2A (COATED) THREAD (ASA R1.1-1960).
- LENGTH OF INCOMPLETE OR UNDERCUT THREADS.

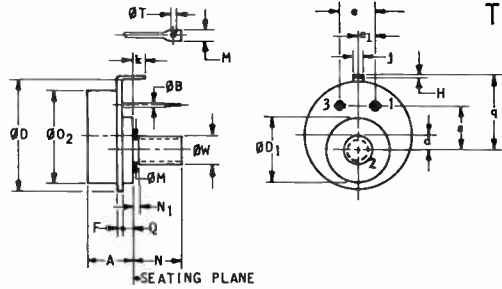

TO 82

SYM.	INCHES		MILLIMETERS		NOTES
	MIN.	MAX.	MIN.	MAX.	
A	.500	.560	12.70	14.22	
ØB	.045	.060	1.15	1.52	5
d	.140	.170	3.56	4.31	
ØD	1.240	1.280	31.50	32.51	
ØO1	.730	.770	18.55	19.55	
ØO2	—	1.125	—	28.57	
e	.360	.400	9.15	10.16	
e1	.180	.200	4.58	5.08	
F	.035	.060	.89	1.52	
k	.130	.190	3.31	4.82	
J	.140	.170	3.56	4.31	
H	.014	.025	.36	.60	
M	.090	.110	2.29	2.79	1
ØM	.278	.312	7.07	7.92	
N	.550	.580	13.97	14.73	
N1	—	.107	—	2.71	2
q	.810	.850	20.58	21.59	
Q	.110	.140	2.80	3.55	5
a	.480	.520	12.20	13.20	1
ØT	.050	.070	1.27	1.77	4
ØW	.2806	.2854	7.128	7.249	3

NOTES-

- 1-CONTOUR AND ORIENTATION OF TERMINAL FLATS ARE UNDEFINED.
- 2-LENGTH OF INCOMPLETE OR UNDERCUT THREADS.
- 3-PITCH DIA. OF 5/16-24 UNF-2A (COATED) THREADS (ASA B1.1).
- 4-DIA. OF HOLE OR WIDTH OF SLOT ON EITHER SIDE OF TERMINALS.
- 5-LEAD DIAMETER UNCONTROLLED ABOVE THE SEATING PLANE.

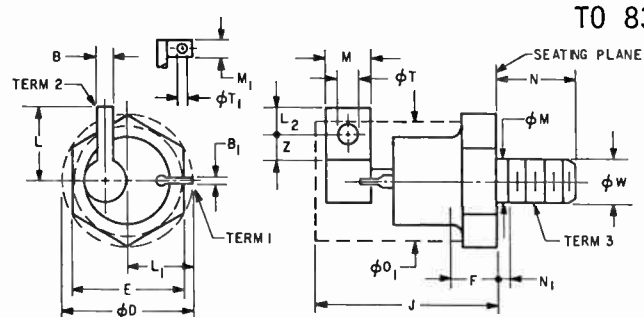

TO 83

MILLIMETER DIMENSIONS ARE DERIVED FROM ORIGINAL INCH DIMENSIONS

SYMBOL	INCHES		MILLIMETERS		NOTES
	MIN.	MAX.	MIN.	MAX.	
B	.060	.115	1.53	2.92	1
B1	.012	.050	.31	1.27	1
ØD	—	1.227	—	31.16	—
ØO1	—	1.031	—	26.18	2
E	1.031	1.063	26.19	27.00	—
F	.170	.500	4.4	12.7	3
J	—	1.810	—	45.97	2
L	—	.650	—	16.51	2
L1	—	.575	—	14.60	2
L2	.180	—	4.58	—	—
M	.360	.470	9.2	11.9	1
M1	.115	.160	2.93	4.06	1
ØM	.425	.499	10.80	12.67	4
N	.797	.827	20.25	21.00	—
N1	—	.125	—	3.17	4
ØT	.180	.260	4.58	6.60	—
ØT1	.060	.080	1.53	2.03	—
ØW	.4619	.4675	11.733	11.874	5
Z	.180	—	4.58	—	6

NOTES:

1. CONTOUR AND ORIENTATION OF FIXED TERMINAL LUGS ARE UNDEFINED.
2. THE BODY AND TERMINALS OF THE DEVICE, WITH THE EXCEPTION OF THE EXTENDED LUG LENGTH L AND L1, LIES WITHIN THE CYLINDER DEFINED BY ØD1 AND LENGTH J.
3. A CHAMFER (OR UNDERCUT) ON ONE OR BOTH ENDS OF THE HEXAGONAL PORTIONS IS OPTIONAL.
4. LENGTH OF INCOMPLETE OR UNDERCUT THREADS OF ØM.
5. PITCH DIA. OF 1/2-20 UNF -2A (COATED) THREADS (ASA B1.1-1960).
6. MINIMUM FLAT.

TO 84

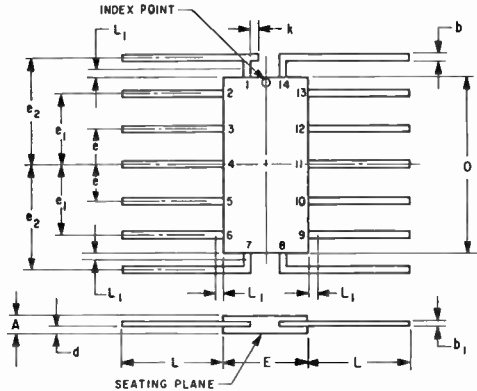

MILLIMETER DIMENSIONS ARE DERIVED FROM BASIC INCH DIMENSIONS

SYMBOL	INCHES		MILLIMETERS		NOTES
	MIN.	MAX.	MIN.	MAX.	
A	.030	.070	.77	1.77	-
b	.010	.019	.254	.482	1
b ₁	.003	.006	.077	.152	1
D	.240	.260	6.10	6.60	-
d	.005	.035	.13	.88	-
E	.135	.155	3.43	3.93	4
e	.045	.055	1.15	1.39	2,4
e ₁	.095	.105	2.42	2.66	2,4
e ₂	.145	.155	3.69	3.93	2,3,4
k	-	.015	-	.38	5
L	.070	-	1.78	-	-
L ₁	-	.015	-	.38	1

NOTES:

1. LEAD DIMENSIONS UNCONTROLLED IN THIS ZONE TO ALLOW FOR BODY AND LEAD FINISH IRREGULARITIES.
2. LEADS MISSING FROM THEIR DESIGNATED POSITIONS SHALL ALSO BE COUNTED WHEN NUMBERING LEADS FOR SPECIFIC APPLICATIONS.
3. SPACING AND ANGLE OF THE END LEADS AT THE POINT OF EMERGENCE OF BODY IS NOT CONTROLLED.
4. LEAD SPACING SHALL BE MEASURED WITHIN .030" (.762 MM) FROM THE POINT OF EMERGENCE FROM THE BODY OR, AS IN THE CASE OF END LEAD, FROM THE POINT WHERE THE EXTENSION OF THE BODY OUTLINE INTERSECTS THE END LEADS.
5. MECHANICAL INDEX, OPTIONAL.

TO 85

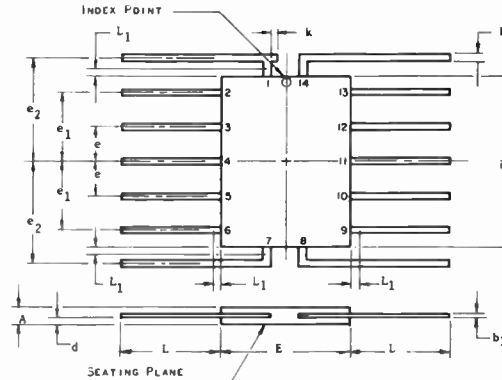

SYMBOL	INCHES		MILLIMETERS		NOTE
	MIN.	MAX.	MIN.	MAX.	
A	.030	.070	.762	1.77	-
b	.010	.019	.254	.482	1
b ₁	.003	.006	.077	.152	1
D	.240	.275	6.10	6.98	-
d	.005	.035	.127	.889	-
E	.160	.185	4.07	4.69	4
e	.045	.055	1.15	1.39	2,4
e ₁	.095	.105	2.42	2.66	2,4
e ₂	.145	.155	3.69	3.93	2,3,4
k	-	.015	-	.381	5
L	.070	-	1.78	-	-
L ₁	-	.015	-	.381	1

NOTES:

1. LEAD DIMENSIONS UNCONTROLLED IN THIS ZONE TO ALLOW FOR BODY AND LEAD FINISH IRREGULARITIES.
2. LEADS MISSING FROM THEIR DESIGNATED POSITIONS SHALL ALSO BE COUNTED WHEN NUMBERING LEADS FOR SPECIFIC APPLICATIONS.
3. SPACING AND ANGLE OF THE END LEADS AT THE POINT OF EMERGENCE OF BODY IS NOT CONTROLLED.
4. LEAD SPACING SHALL BE MEASURED WITHIN .030" (.762 MM) FROM THE POINT OF EMERGENCE FROM THE BODY OR, AS IN THE CASE OF END LEAD, FROM THE POINT WHERE THE EXTENSION OF THE BODY OUTLINE INTERSECTS THE END LEADS.
5. MECHANICAL INDEX, OPTIONAL.

TO 86

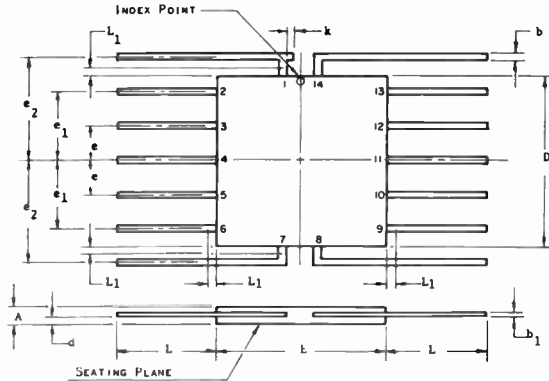

SYMBOL	INCHES		MILLIMETERS		NOTE
	MIN.	MAX.	MIN.	MAX.	
A	.030	.070	.762	1.77	
b	.010	.019	.254	.482	1
b ₁	.003	.008	.077	.152	1
D	.240	.275	6.10	6.98	
d	.005	.035	.127	.889	
E	.240	.260	6.10	6.60	4
e	.045	.055	1.15	1.39	2,4
e ₁	.095	.105	2.42	2.66	2,4
e ₂	.145	.155	3.69	3.93	2,3,4
k	-	.015	-	.381	5
L	.070	-	1.78	-	
L ₁	-	.015	-	.381	1

NOTES:

1. LEAD DIMENSIONS UNCONTROLLED IN THIS ZONE TO ALLOW FOR BODY AND LEAD FINISH IRREGULARITIES.
2. LEADS MISSING FROM THEIR DESIGNATED POSITIONS SHALL ALSO BE COUNTED WHEN NUMBERING LEADS FOR SPECIFIC APPLICATIONS.
3. SPACING AND ANGLE OF THE END LEADS AT THE POINT OF EMERGENCE OF BODY IS NOT CONTROLLED.
4. LEAD SPACING SHALL BE MEASURED WITHIN .030 (.762 MM) FROM THE POINT OF EMERGENCE FROM THE BODY OR, AS IN THE CASE OF END LEAD, FROM THE POINT WHERE THE EXTENSION OF THE BODY OUTLINE INTERSECTS THE END LEADS.
5. MECHANICAL INDEX, OPTIONAL

TO 87

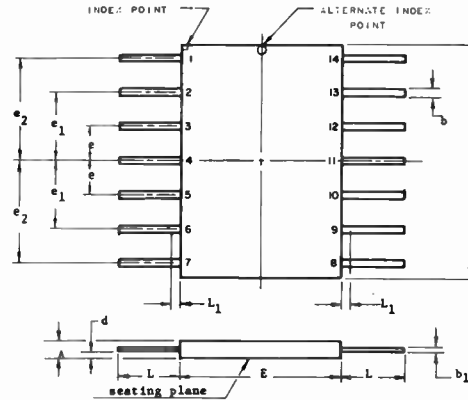

SYMBOL	INCHES		MILLIMETERS		NOTE
	MIN.	MAX.	MIN.	MAX.	
A	.030	.070	.762	1.77	
b	.010	.019	.254	.482	1
b ₁	.003	.008	.077	.152	1
D	.360	.410	9.15	10.41	
d	.005	.025	.127	.889	
E	.240	.275	6.10	6.98	
e	.045	.055	1.15	1.39	2,3
e ₁	.095	.105	2.42	2.66	2,3
e ₂	.145	.155	3.69	3.93	2,3
L	.070	-	1.78	-	
L ₁	-	.015	-	.381	1

NOTES:

1. LEAD DIMENSIONS UNCONTROLLED IN THIS ZONE TO ALLOW FOR BODY AND LEAD FINISH IRREGULARITIES.
2. LEADS MISSING FROM THEIR DESIGNATED POSITIONS SHALL ALSO BE COUNTED WHEN NUMBERING LEADS FOR SPECIFIC APPLICATIONS.
3. LEAD SPACING SHALL BE MEASURED WITHIN .030 (.762 MM) FROM THE POINT OF EMERGENCE FROM THE BODY.

TO 88

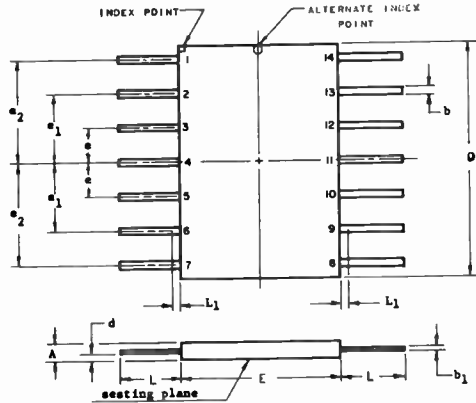

SYMBOL	INCHES		MILLIMETERS		NOTE
	MIN	MAX	MIN	MAX	
A	.030	.070	.762	1.77	
b	.010	.019	.254	.482	1
b ₁	.003	.006	.077	.152	1
D	.330	.350	8.38	8.89	
d	.005	.035	.127	.889	
E	.240	.260	6.10	6.60	
e	.045	.055	1.15	1.39	2,3
e ₁	.095	.105	2.42	2.66	2,3
e ₂	.145	.155	3.69	3.93	2,3
L	.070	-	1.78	-	
L ₁	-	.015	-	.381	1

NOTES:

1. LEAD DIMENSIONS UNCONTROLLED IN THIS ZONE TO ALLOW FOR BODY AND LEAD FINISH IRREGULARITIES.
2. LEADS MISSING FROM THEIR DESIGNATED POSITIONS SHALL ALSO BE COUNTED WHEN NUMBERING LEADS FOR SPECIFIC APPLICATIONS.
3. LEAD SPACING SHALL BE MEASURED WITHIN .030 (.762 MM) FROM THE POINT OF EMERGENCE FROM THE BODY.

TO 89

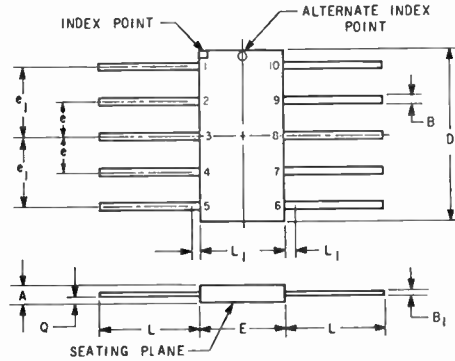

MILLIMETER DIMENSIONS ARE DERIVED FROM ORIGINAL INCH DIMENSIONS

SYMBOL	INCHES		MILLIMETERS		NOTES
	MIN.	MAX.	MIN.	MAX.	
A	.030	.070	.77	1.77	-
B	.010	.019	.254	.482	1
B ₁	.003	.006	.077	.152	1
D	.240	.290	6.10	7.36	-
E	.135	.155	3.43	3.93	-
e	.045	.055	1.15	1.39	2,3
e ₁	.095	.105	2.42	2.66	2,3
L	.070	-	1.78	-	
L ₁	-	.015	-	.381	1
Q	.005	.035	.127	.889	-

NOTES:

1. LEAD DIMENSIONS UNCONTROLLED IN THIS ZONE TO ALLOW FOR BODY FLASH AND LEAD FINISH BUILD-UP.
2. LEADS MISSING FROM THEIR DESIGNATED POSITIONS SHALL BE COUNTED WHEN NUMBERING LEADS FOR SPECIFIC APPLICATIONS.
3. LEAD SPACING SHALL BE MEASURED WITHIN .030 (.762 MM) FROM THE POINT OF EMERGENCE FROM THE BODY.

TO 90

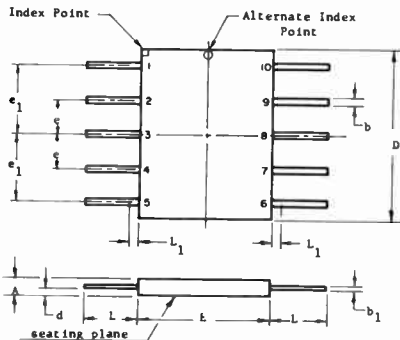

SYMBOL	INCHES		MILLIMETERS		NOTE
	MIN	MAX	MIN	MAX	
A	.030	.070	.762	1.77	
b	.010	.019	.254	.482	1
b ₁	.003	.006	.077	.152	1
D	.240	.290	6.10	7.36	
d	.005	.035	.127	.889	
E	.160	.185	4.07	4.69	
e	.045	.055	1.15	1.39	2,3
e ₁	.095	.105	2.42	2.66	2,3
L	.070	-	1.78	-	
L ₁	-	.015	-	.381	1

NOTES:

- Lead Dimensions uncontrolled in this zone to allow for body and lead finish irregularities.
- Leads missing from their designated positions shall also be counted when numbering leads for specific applications.
- Lead spacing shall be measured within .030 (.762 mm) from the point of emergence from the body.

TO 91

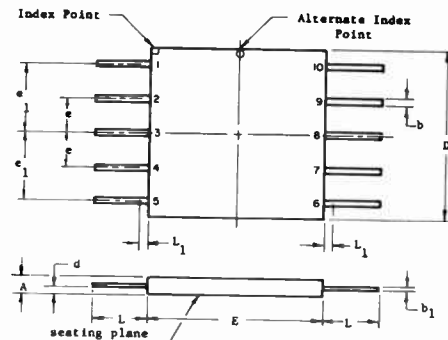

SYMBOL	INCHES		MILLIMETERS		NOTE
	MIN	MAX	MIN	MAX	
A	.030	.070	.762	1.77	
b	.010	.019	.254	.482	1
b ₁	.003	.006	.077	.152	1
D	.240	.290	6.10	7.36	
d	.005	.035	.127	.889	
E	.240	.260	6.10	6.60	
e	.045	.055	1.15	1.39	2,3
e ₁	.095	.105	2.42	2.66	2,3
L	.070	-	1.78	-	
L ₁	-	.015	-	.381	1

NOTES:

- Lead Dimensions uncontrolled in this zone to allow for body and lead finish irregularities.
- Leads missing from their designated positions shall also be counted when numbering leads for specific applications.
- Lead spacing shall be measured within .030 (.762 mm) from the point of emergence from the body.

TO 92

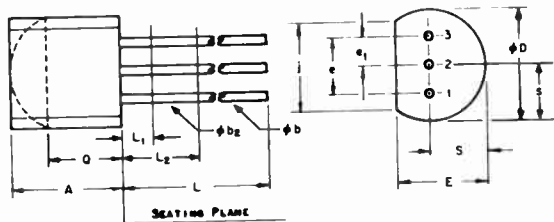

SYMBOL	INCHES		MILLIMETERS		NOTES
	MIN.	MAX.	MIN.	MAX.	
A	.170	.210	4.58	5.33	1, 3
Øb	.016	.021	.407	.533	
Øb2	.016	.019	.407	.482	3
ØD	.175	.205	4.96	5.20	1, 3
E	.125	.165	3.94	4.19	
e	.095	.105	2.42	2.66	3
e1	.045	.055	1.15	1.39	
J	.135		3.43		1, 3
L	.500		12.70		
L1		.050		1.27	3
L2	.250		6.35		3
Q	.115		2.93		2
S	.080	.105	2.42	2.66	

NOTES:

- THREE LEADS
- CONTOUR OF THE PACKAGE BEYOND THIS ZONE IS UNCONTROLLED.
- (THREE LEADS) Øb₂ APPLIES BETWEEN L₁ AND L₂. Øb APPLIES BETWEEN L₂ AND .5" (12.70 MM) FROM SEATING PLANE. DIAMETER IS UNCONTROLLED IN L₁ AND BEYOND .5" (12.70 MM) FROM SEATING PLANE.

TO 93

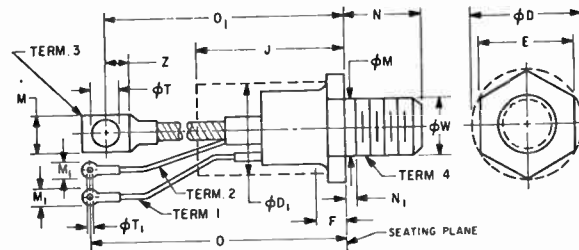

MILLIMETER DIMENSIONS ARE DERIVED FROM ORIGINAL INCH DIMENSIONS

SYMBOL	INCHES		MILLIMETERS		NOTES
	MIN.	MAX.	MIN.	MAX.	
ØD	-	1.443	-	36.65	-
ØD1	-	1.212	-	30.78	1
E	1.212	1.250	30.79	31.75	-
F	.230	1.000	5.9	25.4	5
J	-	3.625	-	92.07	1, 7
M	.530	.755	13.5	19.1	2
ØM	.660	.749	16.77	19.02	3
M1	.215	.300	5.47	7.62	2, 8
N	1.047	1.077	26.60	27.35	-
N1	-	.156	-	3.96	3
O	7.350	8.100	186.7	205.7	-
O1	7.350	8.100	186.7	205.7	-
ØT	.260	.350	6.61	8.89	-
ØT1	.140	.155	3.56	3.93	-
ØW	.7029	.7094	17.854	18.018	4
Z	.340	-	8.64	-	6

NOTES:

- THE BODY OF THE DEVICE WITH EXCEPTION OF THE HEXAGON, THREAD, AND FLEXIBLE LEAD EXTENSIONS LIES WITHIN ØD1 AND LENGTH J.
- ANGULAR ORIENTATION OF THESE TERMINALS WITH RESPECT TO HEXAGON PORTION IS UNDEFINED. SQUARE OR RADIUS ON END OF TERMINALS IS OPTIONAL.
- LENGTH OF INCOMPLETE OR UNDERCUT THREADS OF ØM.
- PITCH DIAMETER OF 3/4-16UNF-2A (COATED) THREADS (ASA B1.1-1960).
- A CHAMFER (OR UNDERCUT) ON ONE OR BOTH ENDS OF HEXAGON PORTION IS OPTIONAL.
- MINIMUM FLAT.
- SEATED HEIGHT WITH LEAD BENT AT RIGHT ANGLES.
- FLEXIBLE LEADS FOR TERMINALS 1 AND 2 ARE IDENTIFIED BY COLOR CODING FOR SPECIFIC APPLICATIONS.

TO 94

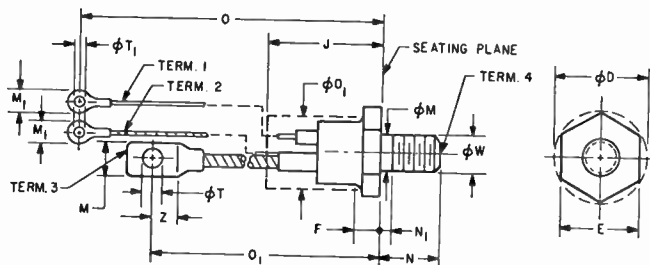

MILLIMETER DIMENSIONS ARE DERIVED FROM ORIGINAL INCH DIMENSIONS

SYMBOL	INCHES		MILLIMETERS		NOTES
	MIN.	MAX.	MIN.	MAX.	
ϕ_0	-	1.227	-	31.16	-
ϕ_{D1}	-	1.031	-	26.18	1
E	1.031	1.063	26.19	27.00	-
F	.170	.500	4.4	12.7	5
J	-	2.500	-	63.50	1,7
M	.437	.650	11.1	16.5	2
ϕ_M	.425	.499	10.80	12.67	3
M_1	.215	.300	5.49	7.62	2,B
N	.797	.827	20.25	21.00	-
N_1	-	.125	-	3.17	3
O	6.850	7.500	174.0	190.5	-
O_1	5.775	6.265	146.7	159.1	-
ϕ_T	.260	.310	6.61	7.87	-
ϕ_{T1}	.140	.150	3.56	3.81	-
ϕ_W	.4619	.4675	11.733	11.874	4
Z	.250	-	6.35	-	6

NOTES:

1. THE DEVICE WITH THE EXCEPTION OF THE HEXAGON, THREAD, AND FLEXIBLE LEAD EXTENSION LIES WITHIN THE CYLINDER DEFINED BY ϕ_{D1} AND LENGTH J.
2. ANGULAR ORIENTATION OF THESE TERMINALS WITH RESPECT TO HEXAGONAL PORTION IS UNDEFINED. SQUARE OR RADIUS ON END OF TERMINALS IS OPTIONAL.
3. LENGTH OF INCOMPLETE OR UNDERCUT THREADS OF ϕ_M .
4. PITCH DIAMETER OF 1/2-20 UNF-2A (COATED) THREADS (ASA B1.1-1960).
5. A CHAMFER (OR UNDERCUT) ON ONE OR BOTH ENDS OF HEXAGONAL PORTION IS OPTIONAL.
6. MINIMUM FLAT.
7. SEATED HEIGHT WITH LEADS BENT AT RIGHT ANGLES.
8. FLEXIBLE LEADS FOR TERM 1 AND 2 ARE IDENTIFIED BY COLD R CODING FOR SPECIFIC APPLICATIONS.

TO 95

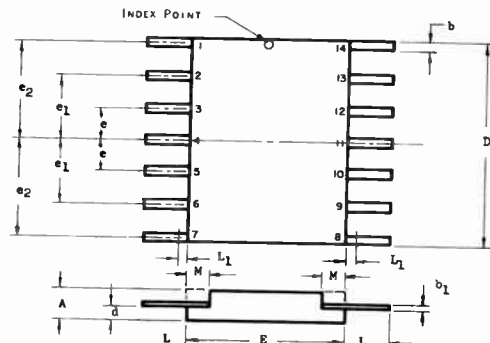

SYMBOL	INCHES		MILLIMETERS		NOTES
	MIN.	MAX.	MIN.	MAX.	
A	.030	.070	.762	1.77	
b	.010	.019	.254	.482	
b_1	.003	.006	.077	.152	
D	.308	.329	7.83	8.35	
d	.005	.035	.127	.889	
E	.240	.260	6.10	6.60	
e	.045	.055	1.15	1.39	2, 3
e_1	.095	.105	2.42	2.66	2, 3
e_2	.145	.155	3.69	3.93	2, 3
L	.070	-	1.78	-	
L_1	-	.015	-	.381	1
M	-	.040	-	1.01	4

NOTES:

1. LEAD DIMENSION UNCONTROLLED IN THIS ZONE TO ALLOW FOR BODY AND LEAD FINISH IRREGULARITIES.
2. LEADS MISSING FROM THEIR DESIGNATED POSITIONS SHALL ALSO BE COUNTED WHEN NUMBERING LEADS FOR SPECIFIC APPLICATIONS.
3. LEAD SPACING SHALL BE MEASURED WITHIN .030" (.762 MM) FROM THE POINT OF EMERGENCE FROM THE BODY.
4. IRREGULARITY IN BODY OUTLINE NOT CONTROLLED IN THIS ZONE.

TO 96

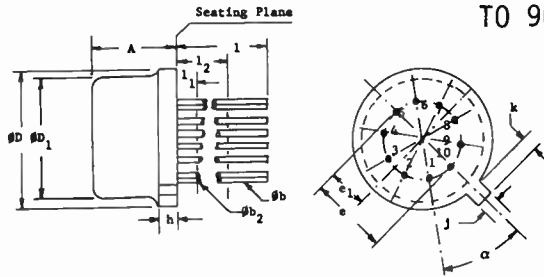

SYMBOL	INCHES		MILLIMETERS		NOTES
	MIN.	MAX.	MIN.	MAX.	
A	.240	.260	6.10	6.60	2
Øb	.016	.021	.406	.533	2
Øb ₂	.016	.019	.406	.483	2
ØD	.335	.370	8.51	9.40	
Ød ₁	.305	.335	7.75	8.51	
e	.230 T.P.		5.84	T.P.	4
e ₁	.115 T.P.		2.92	T.P.	4
h		.040		1.02	
j	.028	.034	.711	.864	
k	.029	.045	.737	1.14	3
l	.500		7.62		2
l ₁		.050		1.27	2
l ₂	.250		6.35		2
α	36° T.P.		36° T.P.		4,6

NOTES:

- (TEN LEADS). MAXIMUM NUMBER OF LEADS OMITTED IN THIS OUTLINE, "ONE" (1). THE NUMBER AND POSITION OF LEADS ACTUALLY PRESENT ARE INDICATED IN THE PRODUCT REGISTRATION. OUTLINE DESIGNATION DETERMINED BY THE LOCATION AND MINIMUM ANGULAR SPACING OF ANY TWO ADJACENT LEADS.
- (ALL LEADS) Øb, APPLIES BETWEEN l₁ AND l₂. Øb APPLIES BETWEEN l₁ AND .500" (12.70 MM) FROM SEATING PLANE. DIAMETER IS UNCONTROLLED IN l₁ AND BEYOND .500" (12.70 MM) FROM SEATING PLANE.
- MEASURED FROM MAXIMUM DIAMETER OF THE PRODUCT.
- LEADS HAVING MAXIMUM DIAMETER .019" (.483 MM) MEASURED IN GAGING PLANE .054" (1.37 MM) + .001" (.025 MM) - .000" (.000 MM) BELOW THE SEATING PLANE OF THE PRODUCT SHALL BE WITHIN .007" (.178 MM) OF THEIR TRUE POSITION RELATIVE TO A MAXIMUM WIDTH TAB.
- THE PRODUCT MAY BE MEASURED BY DIRECT METHODS OR BY GAGE.
- TAB CENTERLINE.

TO 97

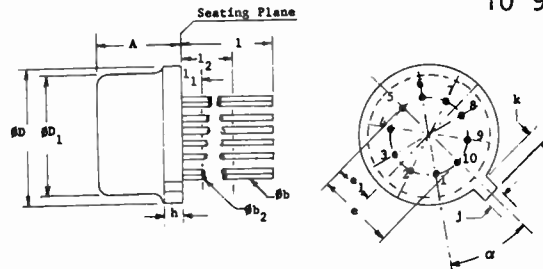

SYMBOL	INCHES		MILLIMETERS		NOTES
	MIN.	MAX.	MIN.	MAX.	
A	.140	.160	3.56	4.06	
Øb	.016	.021	.406	.533	2
Øb ₂	.016	.019	.406	.483	2
ØD	.335	.370	8.51	9.40	
Ød ₁	.305	.335	7.75	8.51	
e	.230 T.P.		5.84	T.P.	4
e ₁	.115 T.P.		2.92	T.P.	4
h		.040		1.02	
j	.028	.034	.711	.864	
k	.029	.045	.737	1.14	3
l	.500		7.62		2
l ₁		.050		1.27	2
l ₂	.250		6.35		2
α	36° T.P.		36° T.P.		4,6

NOTES:

- (TEN LEADS). MAXIMUM NUMBER OF LEADS OMITTED IN THIS OUTLINE, "ONE" (1). THE NUMBER AND POSITION OF LEADS ACTUALLY PRESENT ARE INDICATED IN THE PRODUCT REGISTRATION. OUTLINE DESIGNATION DETERMINED BY THE LOCATION AND MINIMUM ANGULAR SPACING OF ANY TWO ADJACENT LEADS.
- (ALL LEADS) Øb, APPLIES BETWEEN l₁ AND l₂. Øb APPLIES BETWEEN l₁ AND .500" (12.70 MM) FROM SEATING PLANE. DIAMETER IS UNCONTROLLED IN l₁ AND BEYOND .500" (12.70 MM) FROM SEATING PLANE.
- MEASURED FROM MAXIMUM DIAMETER OF THE PRODUCT.
- LEADS HAVING MAXIMUM DIAMETER .019" (.483 MM) MEASURED IN GAGING PLANE .054" (1.37 MM) + .001" (.025 MM) - .000" (.000 MM) BELOW THE SEATING PLANE OF THE PRODUCT SHALL BE WITHIN .007" (.178 MM) OF THEIR TRUE POSITION RELATIVE TO A MAXIMUM WIDTH TAB.
- THE PRODUCT MAY BE MEASURED BY DIRECT METHODS OR BY GAGE.
- TAB CENTERLINE.

TO 98

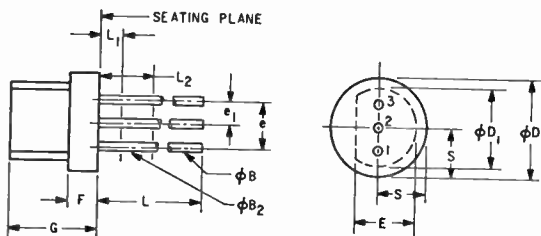

MILLIMETER DIMENSIONS ARE DERIVED FROM ORIGINAL INCH DIMENSIONS

SYMBOL	INCHES		MILLIMETERS		NOTES
	MIN.	MAX.	MIN.	MAX.	
ϕD	.195	.205	4.96	5.20	-
ϕD_1	.165	.190	4.20	4.82	-
ϕB	.016	.021	.407	.533	1
ϕB_2	.016	.019	.407	.482	-
E	.110	.140	2.80	3.55	-
e	.095	.105	2.42	2.66	-
e ₁	.045	.055	1.15	1.39	-
F	.055	.075	1.40	1.90	-
G	.200	.265	5.08	6.73	-
L	.500	-	12.70	-	1
L ₁	-	.050	-	1.27	1
L ₂	.250	-	6.35	-	1
S	.090	.105	2.28	2.66	-

NOTES:

- (THREE LEADS) ϕB_2 APPLIES BETWEEN L₁ AND L₂. ϕB APPLIES BETWEEN L₂ AND .5" (12.70 MM) FROM SEATING PLANE. DIAMETER IS UNCONTROLLED IN L₁ AND BEYOND .5" (12.70MM) FROM SEATING PLANE.

TO 99

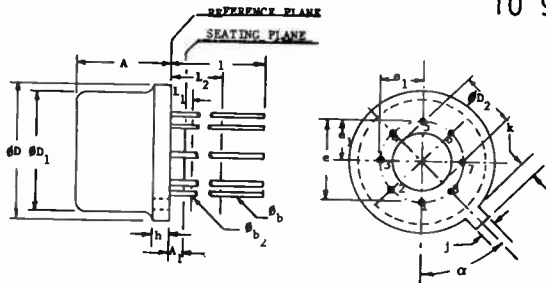

SYMBOL	INCHES		MILLIMETERS		NOTES
	MIN.	MAX.	MIN.	MAX.	
A	.165	.185	4.19	4.70	
A ₁	.010	.040	.254	1.02	
ϕB_1	.016	.021	.406	.533	2
ϕB_2	.016	.019	.406	.483	2
ϕD_2	.335	.370	8.51	9.40	
ϕD_1	.305	.335	7.75	8.51	
ϕD_2	.140	.160	3.56	4.06	
e	.200 T.P.		5.08 T.P.		4
e ₁	.100 T.P.		2.54 T.P.		4
h		.040		1.02	
j	.028	.034	.711	.864	
k	.029	.045	.737	1.14	3
l	.500		12.70		2
l ₁		.050		1.27	2
l ₂	.250	45° T.P.	6.35	45° T.P.	4, 6

NOTES:

- (EIGHT LEADS). MAXIMUM NUMBER OF LEADS OMITTED IN THIS OUTLINE, "THREE" (3). THE NUMBER AND POSITION OF LEADS ACTUALLY PRESENT ARE INDICATED IN THE PRODUCT REGISTRATION. OUTLINE DESIGNATION DETERMINED BY THE LOCATION AND MINIMUM ANGULAR SPACING OF ANY TWO ADJACENT LEADS.
- (ALL LEADS) ϕB_2 APPLIES BETWEEN l₁ AND l₂. ϕB APPLIES BETWEEN l₂ AND .500" (12.70 MM) FROM REFERENCE PLANE. DIAMETER IS UNCONTROLLED IN l₁ AND BEYOND .500" (12.70 MM) FROM REFERENCE PLANE.
- MEASURED FROM MAXIMUM DIAMETER OF THE PRODUCT.
- LEADS HAVING MAXIMUM DIAMETER .019" (.483 MM) MEASURED IN GAGING PLANE .054" (1.37 MM) + .001" (.025 MM) - .000" (.000 MM) BELOW THE REFERENCE PLANE OF THE PRODUCT SHALL BE WITHIN .007" (.178 MM) OF THEIR TRUE POSITION RELATIVE TO A MAXIMUM WIDTH TAB.
- THE PRODUCT MAY BE MEASURED BY DIRECT METHODS OR BY GAGE.
- TAB CENTERLINE.

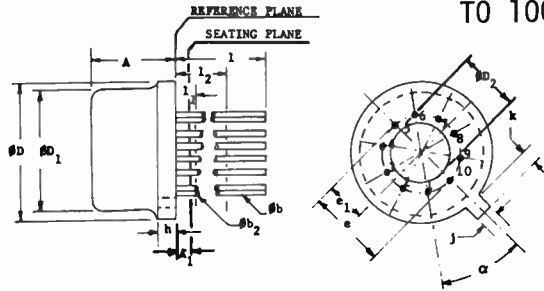

SYMBOL	INCHES		MILLIMETERS		NOTES
	MIN.	MAX.	MIN.	MAX.	
A	.185	.185	4.70	4.70	
A ₁	.010	.040	.254	1.02	
Øb	.016	.021	.406	.533	2
Øb ₂	.016	.019	.406	.483	2
ØD	.335	.370	8.51	9.40	
ØD ₁	.305	.335	7.75	8.51	
ØD ₂	.140	.160	3.56	4.06	
e	.230	T.P.	5.84	T.P.	4
e ₁	.115	T.P.	2.92	T.P.	4
h		.040		1.02	
j	.028	.034	.711	.864	
k	.029	.045	.737	1.14	3
l	.500		12.70		2
l ₁		.050		1.27	2
l ₂	.250		6.35		2
c		36° T.P.		36° T.P.	4, 6

NOTES:

- (TEN LEADS). MAXIMUM NUMBER OF LEADS OMITTED IN THIS OUTLINE, "ONE" (1). THE NUMBER AND POSITION OF LEADS ACTUALLY PRESENT ARE INDICATED IN THE PRODUCT REGISTRATION. OUTLINE DESIGNATION DETERMINED BY THE LOCATION AND MINIMUM ANGULAR SPACING OF ANY TWO ADJACENT LEADS.
- (ALL LEADS) Øb₂ APPLIES BETWEEN l₁ AND l₂. Øb APPLIES BETWEEN l₂ AND .500" (12.70 MM) FROM REFERENCE PLANE. DIAMETER IS UNCONTROLLED IN l₁ AND BEYOND .500" (12.70 MM) FROM REFERENCE PLANE.
- MEASURED FROM MAXIMUM DIAMETER OF THE PRODUCT.
- LEADS HAVING MAXIMUM DIAMETER .019" (.483 MM) MEASURED IN GAGING PLANE .054" (1.37 MM) ± .001" (.025 MM) - .000" (.000 MM) BELOW THE REFERENCE PLANE OF THE PRODUCT SHALL BE WITHIN .007" (.178 MM) OF THEIR TRUE POSITION RELATIVE TO A MAXIMUM WIDTH TAB.
- THE PRODUCT MAY BE MEASURED BY DIRECT METHODS OR BY GAGE.
- TAB CENTERLINE.

TO 100

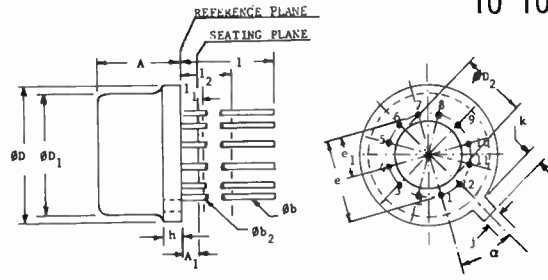

SYMBOL	INCHES		MILLIMETERS		NOTES
	MIN.	MAX.	MIN.	MAX.	
A	.185	.185	4.70	4.70	
A ₁	.010	.040	.254	1.02	
Øb	.016	.021	.406	.533	2
Øb ₂	.016	.019	.406	.483	2
ØD	.335	.370	8.51	9.40	
ØD ₁	.305	.335	7.75	8.51	
ØD ₂	.140	.160	3.56	4.06	
e	.230	T.P.	5.84	T.P.	4
e ₁	.115	T.P.	2.92	T.P.	4
h		.040		1.02	
j	.028	.034	.711	.864	
k	.029	.045	.737	1.14	3
l	.500		12.70		2
l ₁		.050		1.27	2
l ₂	.250		6.35		2
c		30° T.P.		30° T.P.	4, 6

NOTES:

- (TWELVE LEADS). MAXIMUM NUMBER OF LEADS OMITTED IN THIS OUTLINE, "ONE" (1). THE NUMBER AND POSITION OF LEADS ACTUALLY PRESENT ARE INDICATED IN THE PRODUCT REGISTRATION. OUTLINE DESIGNATION DETERMINED BY THE LOCATION AND MINIMUM ANGULAR SPACING OF ANY TWO ADJACENT LEADS.
- (ALL LEADS) Øb₂ APPLIES BETWEEN l₁ AND l₂. Øb APPLIES BETWEEN l₂ AND .500" (12.70 MM) FROM REFERENCE PLANE. DIAMETER IS UNCONTROLLED IN l₁ AND BEYOND .500" (12.70 MM) FROM REFERENCE PLANE.
- MEASURED FROM MAXIMUM DIAMETER OF THE PRODUCT.
- LEADS HAVING MAXIMUM DIAMETER .019" (.483 MM) MEASURED IN GAGING PLANE .054" (1.37 MM) ± .001" (.025 MM) - .000" (.000 MM) BELOW THE REFERENCE PLANE OF THE PRODUCT SHALL BE WITHIN .007" (.178 MM) OF THEIR TRUE POSITION RELATIVE TO A MAXIMUM WIDTH TAB.
- THE PRODUCT MAY BE MEASURED BY DIRECT METHODS OR BY GAGE.
- TAB CENTERLINE.

TO 101

TO 102

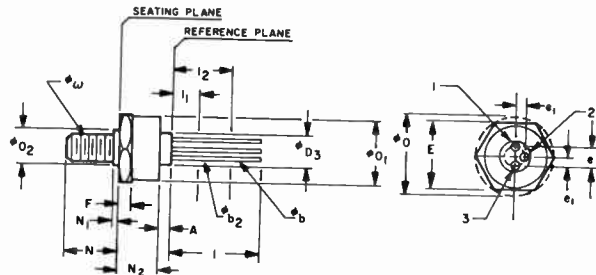

SYMBOL	INCHES		MILLIMETERS		NOTES
	MIN.	MAX.	MIN.	MAX.	
A	.045	.060	1.14	1.52	
ϕb	.016	.021	.406	.533	1
ϕb_2	.016	.019	.406	.483	1
ϕD	.413	.433	10.49	11.00	
ϕD_1	.350	.360	8.89	9.14	
ϕD_2	.175	.190	4.45	4.83	
ϕD_3	.162	.169	4.11	4.29	
E	.362	.375	9.19	9.53	
e	.100 T.P.		2.54 T.P.		2
e_1	.050 T.P.		1.27 T.P.		2
F	.065	.070	1.65	1.78	3
I	.500		12.70		
I_1		.050		1.27	
I_2	.250		6.35		
N	.265	.292	6.73	7.42	
N_1	.020	.035	.508	.889	
N_2	.210	.225	5.33	5.72	
ϕW	.1141	.1177	2.898	2.990	4

NOTES:

- (THREE LEADS) ϕb_2 APPLIES BETWEEN I_1 AND I_2 . ϕb APPLIES BETWEEN I_2 AND 1. DIAMETER IS UNCONTROLLED IN I_1 AND BEYOND .500" (12.70 MM) FROM REFERENCE PLANE.
- LEADS HAVING MAXIMUM DIAMETER .019" (.483 MM) MEASURED IN GAGING PLANE .054" (1.37 MM) + .001" (.025 MM) - .000" (.000 MM) BELOW THE REFERENCE PLANE OF THE DEVICE SHALL BE WITHIN .007" (.178 MM) OF THEIR TRUE POSITIONS.
- A CHAMFER (OR UNDERCUT) ON ONE OR BOTH ENDS OF HEXAGONAL PORTION IS OPTIONAL.
- PITCH DIAMETER OF 6-32 UNC-2A (COATED) THREADS. (ASA B1.1-1960).

TO 103

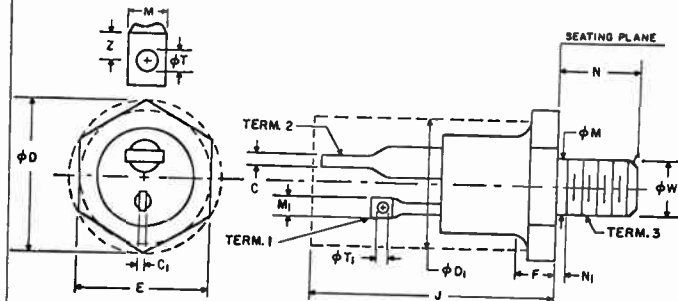

SYMBOL	INCHES		MILLIMETERS		NOTES
	MIN.	MAX.	MIN.	MAX.	
C	.065	.100	1.65	2.54	
C_1	.025	.075	.64	1.90	1,7
ϕD	-	.866	-	21.99	1,7
ϕD_1	-	.728	-	18.49	2
E	.728	.750	18.50	19.05	
F	.125	.205	3.18	5.20	
J	1.200	1.560	30.48	39.62	3
M	.220	.375	5.59	9.52	2
M_1	.125	.187	3.18	4.75	1,7
ϕM	.280	.310	7.12	7.87	1,7
N	.485	.515	12.32	13.08	
N_1	-	.100	-	2.54	4
ϕT	.140	.155	3.56	3.93	
ϕT_1	.050	.070	1.27	1.77	
ϕW	.2806	.2854	7.127	7.249	5
Z	.140	-	3.56	-	6

NOTES:

- CONTOUR AND ANGULAR ORIENTATION OF FIXED TERMINAL LUGS ARE UNDEFINED.
- THE BODY AND TERMINALS OF THE DEVICE LIE WITHIN THE CYLINDER DEFINED BY ϕD_1 AND LENGTH J.
- A CHAMFER (OR UNDERCUT) ON ONE OR BOTH ENDS OF THE HEXAGONAL PORTION IS OPTIONAL.
- LENGTH OF INCOMPLETE OR UNDERCUT THREADS OF ϕM
- PITCH DIAMETER OF 5/16-24 UNF-2A (COATED) THREADS (ASA B1.1-1960)
- MINIMUM FLAT.
- POSITION OF TERMINALS 1 AND 2 IN RELATION TO HEXAGON IS NOT CONTROLLED.

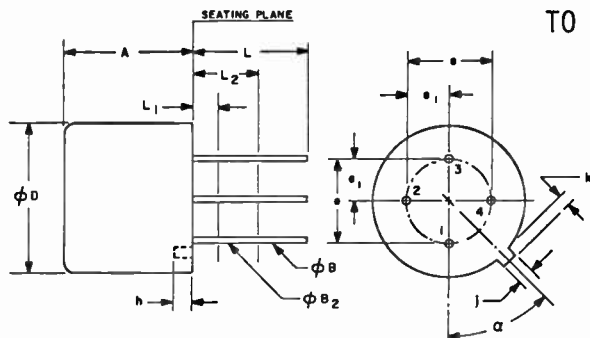

TO 104

MILLIMETER DIMENSIONS ARE DERIVED FROM BASIC INCH DIMENSIONS

SYMBOL	INCHES		MILLIMETERS		NOTES
	MIN.	MAX.	MIN.	MAX.	
A	.170	.210	4.32	5.33	
ϕB	.016	.021	.407	.533	2
ϕB_2	.016	.019	.407	.482	2
ϕD	.220	.240	5.59	6.10	
e	.100 T.P.		2.54 T.P.		1, 3
e_1	.050 T.P.		1.27 T.P.		1, 3
h	-	.030	-	.76	
j	.036	.046	.92	1.16	
k	.028	.048	.72	1.21	4
L	.500	-	12.70	-	2
L_1	-	.050	-	1.27	2
L_2	.250	-	6.35	-	2
α	45° T.P.		-		

NOTES:

1. MAXIMUM NUMBER OF LEADS THAT MAY BE OMITTED IN THIS OUTLINE: "ONE" (1). THE NUMBER AND POSITION OF LEADS ACTUALLY PRESENT ARE INDICATED IN THE PRODUCT REGISTRATION.
2. ϕB_2 APPLIES BETWEEN L_1 AND L_2 . ϕB APPLIES BETWEEN L_2 AND L . DIAMETER IS NOT CONTROLLED IN L_1 .
3. LEADS HAVING MAXIMUM DIAMETER .019" (.482MM) MEASURED IN GAGING PLANE .054" (1.372MM) +.001" (.025MM) -.000" (.000MM) BELOW THE SEATING PLANE OF THE DEVICE SHALL BE WITHIN .007" (.177MM) OF THEIR TRUE POSITIONS RELATIVE TO A MAXIMUM WIDTH TAB.
4. MEASURED FROM ACTUAL MAXIMUM DIAMETER OF ϕD .

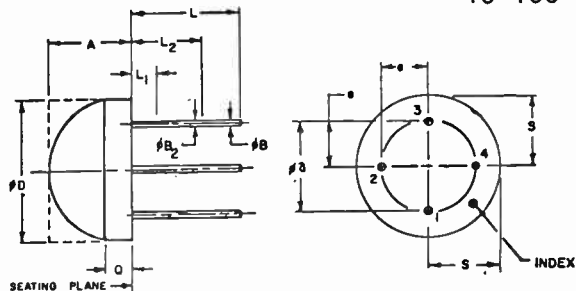

TO 105

MILLIMETER DIMENSIONS ARE DERIVED FROM BASIC INCH DIMENSIONS

SYMBOL	INCHES		MILLIMETERS		NOTES
	MIN.	MAX.	MIN.	MAX.	
A	.120	.240	3.1	6.0	
ϕB	.190	.210	4.83	5.33	
ϕB_2	.016	.021	.407	.533	1, 2
ϕB_2	.016	.019	.407	.482	1, 2
ϕD	.305	.325	7.75	8.25	
e	.090	.110	2.29	2.79	
L	.500	--	12.70	--	1, 2
L_1	--	.050	--	1.27	1, 2
L_2	.250	--	6.35	--	1, 2
Q	.060	--	1.53	--	3
S	.145	.165	3.69	4.19	

NOTES:

1. MAXIMUM NUMBER OF LEADS THAT MAY BE OMITTED IN THIS OUTLINE: "ONE" (1). THE NUMBER AND POSITION OF LEADS ACTUALLY PRESENT ARE INDICATED IN THE PRODUCT REGISTRATION.
2. ϕB_2 APPLIES BETWEEN L_1 AND L_2 . ϕB APPLIES BETWEEN L_2 AND L . DIAMETER IS NOT CONTROLLED IN L_1 .
3. CONTOUR OF PACKAGE BEYOND THIS ZONE IS OPTIONAL, BUT MUST BE WITHIN ϕD AND A .
4. VISUAL OR MECHANICAL INDEX IS OPTIONAL IF ONE LEAD IS OMITTED.

TO 106

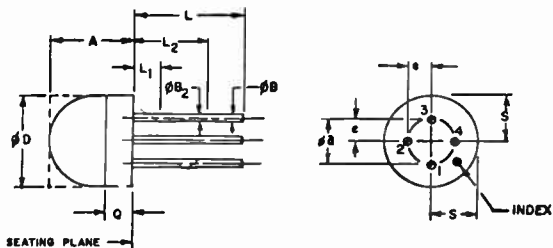

MILLIMETER DIMENSIONS ARE DERIVED FROM BASIC INCH DIMENSIONS

SYMBOL	INCHES		MILLIMETERS		NOTES
	MIN.	MAX.	MIN.	MAX.	
A	.120	.240	3.1	6.0	
ØB	.095	.105	2.42	2.66	
ØB	.016	.021	.407	.533	1, 2
ØB ₂	.016	.019	.407	.482	1, 2
ØD	.192	.222	4.86	5.63	
e	.045	.055	1.15	1.39	
L	.500	--	12.70	--	1, 2
L ₁	--	.050	--	1.27	1, 2
L ₂	.250	--	6.35	--	1, 2
Q	.060	--	1.53	--	3
S	.090	.115	2.29	2.92	

NOTES:

- MAXIMUM NUMBER OF LEADS THAT MAY BE OMITTED IN THIS OUTLINE: "ONE" (1). THE NUMBER AND POSITION OF LEADS ACTUALLY PRESENT ARE INDICATED IN THE PRODUCT REGISTRATION.
- ØB₂ APPLIES BETWEEN L₁ AND L₂. ØB APPLIES BETWEEN L₂ AND L. DIAMETER IS NOT CONTROLLED IN L₁.
- CONTOUR OF PACKAGE BEYOND THIS ZONE IS OPTIONAL, BUT MUST BE WITHIN ØD AND A.
- VISUAL OR MECHANICAL INDEX IS OPTIONAL IF ONE LEAD IS OMITTED

TO 107

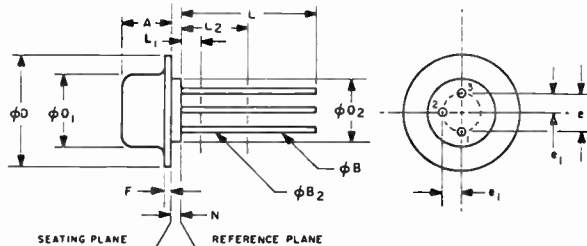

MILLIMETER DIMENSIONS ARE DERIVED FROM BASIC INCH DIMENSIONS

SYMBOL	INCHES		MILLIMETERS		NOTES
	MIN.	MAX.	MIN.	MAX.	
A	.105	.135	2.67	3.42	
ØB	.016	.021	.407	.533	1
ØE ₂	.015	.019	.407	.482	1
ØD	.320	.350	8.13	8.89	
ØD ₁	.200	.215	5.08	5.46	
ØD ₂	.160	.170	4.07	4.32	
e	.100 T.P.		2.54 T.P.		2
e ₁	.050 T.P.		1.27 T.P.		2
F	--	.030	--	.76	
N	.045	.050	1.15	1.52	
L	.500	--	12.70	--	1
L ₁	--	.050	--	1.27	1
L ₂	.250	--	6.35	--	1

NOTES:

- ØB₂ APPLIES BETWEEN L₁ AND L₂. ØB APPLIES BETWEEN L₂ AND L. DIAMETER IS NOT CONTROLLED IN L₁.
- LEADS HAVING MAXIMUM DIAMETER .019" (.482 MM) MEASURED IN GAGING PLANE .052" (1.38 MM) + .001" (.025 MM) - .000" (.000 MM) BELOW THE REFERENCE PLANE OF THE DEVICE SHALL BE WITHIN .007" (.177 MM) OF THEIR TRUE POSITIONS.

TO 108

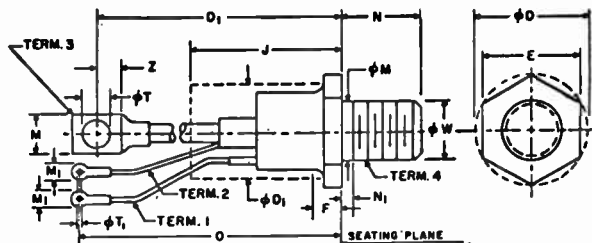

SYMBOL	INCHES		MILLIMETERS		NOTES
	MIN.	MAX.	MIN.	MAX.	
ϕD		1.949		49.50	
ϕD_1		1.631		41.42	1
Z	1.631	1.688	41.43	42.87	
F	.250	.500	6.35	12.70	5
J		4.000	101.60	101.60	1,7
M	.735	1.000	18.67	25.40	2
M_1	.218	.328	5.54	8.33	2,8
ϕM	.880	.999	22.36	25.37	
N	1.375	1.535	34.93	38.98	
N_1		.250		6.35	3
O	9.640	10.140	244.86	257.55	
O_1	9.400	9.780	238.76	248.41	
ϕT	.320	.448	8.13	11.37	
ϕT_1	.140	.172	3.56	4.36	
ϕW	.9382	.9459	23.831	24.025	4
Z	.375		9.53		6

NOTES:

- THE BODY OF THE DEVICE WITH EXCEPTION OF THE HEXAGON, THREAD, AND FLEXIBLE LEAD EXTENSIONS LIES WITHIN ϕD_1 .
- ANGULAR ORIENTATION OF THESE TERMINALS WITH RESPECT TO HEXAGON PORTION IS UNDEFINED. SQUARE OR RADIUS ON END OF TERMINALS IS OPTIONAL.
- LENGTH OF INCOMPLETE OR UNDERCUT THREADS OF ϕM
- PITCH DIAMETER OF 1-12 UNF-2A (COATED) THREADS (ASA B1.1-1960)
- A CHAMFER (OR UNDERCUT) ON ONE OR BOTH ENDS OF HEXAGON PORTION IS OPTIONAL.
- MINIMUM FLAT.
- SEATED HEIGHT WITH LEAD BENT AT RIGHT ANGLES.
- FLEXIBLE LEADS FOR TERMINALS 1 AND 2 ARE IDENTIFIED BY COLOR CODING FOR SPECIFIC APPLICATIONS.

TO 109

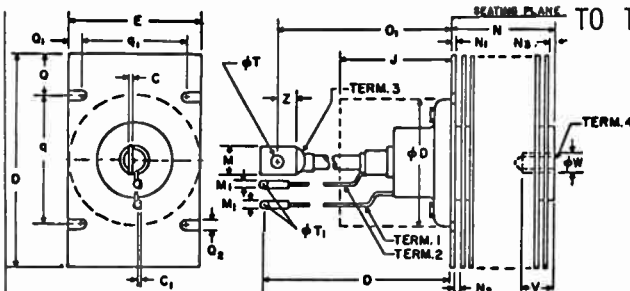

SYMBOL	INCHES		MILLIMETERS		NOTES
	MIN.	MAX.	MIN.	MAX.	
C	.100	.200	2.54	5.08	1
C_1	.020	.040	.51	1.02	1
D	4.937	5.063	125.40	128.60	
ϕD		3.270		83.05	2
E	3.927	4.063	100.00	103.20	
J		4.000		101.60	2,3
M	.735	1.000	18.67	25.40	1
M_1	.218	.320	5.54	8.12	1,6
N		2.130		54.10	
N_1	.125	.220	3.18	5.58	
N_2	.140		3.56		
N_3	.080		2.04		7
O	9.400	10.250	238.76	260.35	
O_1	9.150	10.141	232.41	257.58	
q	.968	1.031	24.59	26.18	
q_1	.468	.531	11.89	13.48	
q_2	.312	.384	7.93	9.75	
q	2.968	3.031	75.39	76.98	
q_1	2.968	3.031	75.39	76.98	
ϕT	.320	.448	8.13	11.37	
ϕT_1	.140	.172	3.56	4.36	
V	.750		19.05		
ϕW	.4675	.4731	11.873	12.016	5
Z	.375		9.52		4

NOTES:

- CONTOUR AND ORIENTATION OF TERMINAL LUGS ARE UNDEFINED.
- THE BODY OF THE DEVICE WITH THE EXCEPTION OF HEATSINK AND FLEXIBLE LEADS LIES WITHIN ϕD .
- SEATED HEIGHT WITH THE LEAD BENT AT RIGHT ANGLES.
- MINIMUM FLAT.
- PITCH DIAMETER OF THREADS - 1/2 - 20 UNF 2B (ASA B1.1-1960)
- PARALLEL, TWISTED OR COAXIAL FLEXIBLE LEADS FOR TERMINALS 1 AND 2 ARE IDENTIFIED BY COLOR CODING FOR SPECIFIC APPLICATIONS. COAXIAL SHIELDED LEAD HAS SHIELD AS TERMINAL 2.
- WHEN DIMENSIONS LESS THAN .180 (4.58 MM) ARE USED, CLEARANCE IN THE SECOND FIN WILL BE PROVIDED.

TO 110

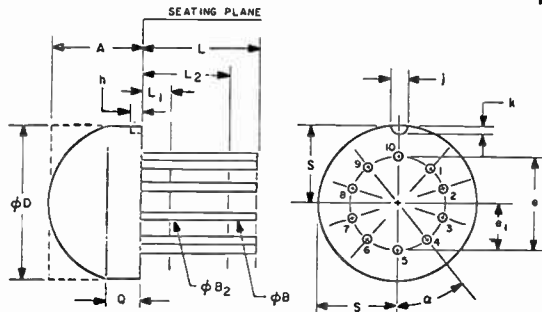

MILLIMETER DIMENSIONS ARE DERIVED FROM BASIC INCH DIMENSIONS

SYMBOL	INCHES		MILLIMETERS		NOTES
	MIN.	MAX.	MIN.	MAX.	
A	.120	.240	3.1	6.0	
ϕB	.016	.021	.407	.533	1, 2
ϕE_2	.016	.019	.407	.482	1, 2
ϕD	.310	.330	7.88	8.38	
e	.195	.205	4.96	5.20	
e1	.098	.102	2.490	2.590	
h	.015	.040	.39	1.01	
j	.025	.050	.64	1.27	
k	.010	.030	.26	.76	
L	.500	-	12.70	-	1, 2
L1	-	.050	-	1.27	1, 2
L2	.250	-	6.35	-	1, 2
S	.145	.165	3.69	4.19	
Q	.060	-	1.53	-	3
α	36° T.P.		36° T.P.		

NOTES:

- (TEN LEADS). MAXIMUM NUMBER OF LEADS THAT CAN BE OMITTED IN THIS OUTLINE, ONE (1).
- ϕB_2 APPLIES BETWEEN L1 AND L2. ϕB APPLIES BETWEEN L2 AND L. DIAMETER IS NOT CONTROLLED IN L1.
- CONTOUR OF PACKAGE BEYOND THIS ZONE OPTIONAL, BUT MUST BE CONFINED WITHIN ϕD AND A.

TO 111

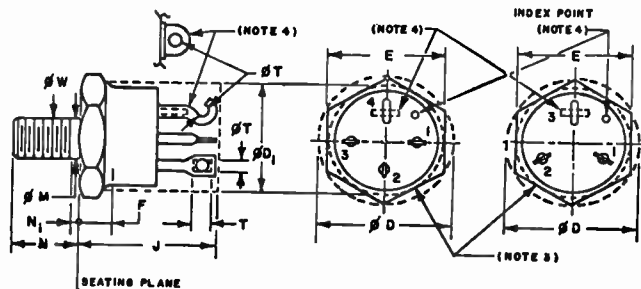

MILLIMETER DIMENSIONS ARE DERIVED FROM BASIC INCH DIMENSIONS

SYMBOL	INCHES		MILLIMETERS		NOTES
	MIN	MAX	MIN	MAX	
ϕD	-	.505	-	12.82	
ϕD_1	.330	.423	8.39	10.74	1
E	.423	.438	10.75	11.12	2
F	.090	.250	2.3	6.3	5
J	.570	.765	14.5	19.3	1
ϕM	.155	.189	3.94	4.80	6
N	.400	.455	10.16	11.55	
N1	-	.078	-	1.98	6
ϕT	.040	.070	1.02	1.77	
T	-	.090	-	2.28	7
ϕW	.1658	.1697	4.212	4.310	8

NOTES:

- Device body and terminals (with exception of hexagon) lie within the cylinder diameter ϕD_1 and length J.
- Position of terminals in relation to the hexagon is not controlled.
- Four terminals. Omission of a maximum of one terminal is optional. Position of the terminals is optional. The number and position of terminals actually present are indicated in the product registration.
- The use of either a hook, short tab, or tall tab terminal contour is optional. An index point is required when the tall tab terminal contour (identical to the adjacent terminals) option is used.
- A chamfer (or undercut) on one or both ends of hexagonal portion is optional.
- Incomplete or undercut threads.
- Elongated hole in tab is optional.
- Pitch diameter of 10-22 UNF-2A coated threads (ASA B1.1-1960).

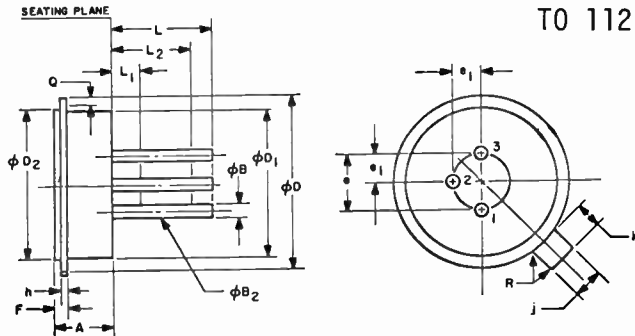

TO 112

MILLIMETER DIMENSIONS ARE DERIVED FROM BASIC INCH DIMENSIONS

SYMBOL	INCHES		MILLIMETERS		NOTES
	MIN.	MAX.	MIN.	MAX.	
A	.090	.115	2.29	2.92	
B	.016	.021	.407	.533	1
B _B	.015	.019	.407	.482	1
B ₂	.305	.320	7.75	8.12	
B ₀	.265	.275	6.74	6.98	
B ₀₁	.270	.320	6.86	8.12	
B ₂	.100 T.P.		2.54 T.P.		2
e	.050 T.P.		1.27 T.P.		2
e ₁	.016	.024	.407	.609	
F	.008	.012	.204	.304	
h	.047	.053	1.194	1.346	
j	.047	.053	1.194	1.346	
k	.400		10.16		3
L		.050		1.27	1
L ₁					1
L ₂	.250		6.35		1
Q	.015		.381		4
R		.009		.22	
a	45° T.P.		45° T.P.		5

NOTES:

- B₂ APPLIES BETWEEN L₁ AND L₂. B_B APPLIES BETWEEN L₂ AND L. DIAMETER IS NOT CONTROLLED IN L₁.
- LEADS HAVING MAXIMUM DIAMETER .019" (.482 MM) MEASURED IN GAGING PLANE .054" (1.38 MM) + .001" (.025 MM) - .000" (1.000 MM) BELOW THE SEATING PLANE OF THE DEVICE SHALL BE WITHIN .007" (.178 MM) OF THEIR TRUE POSITIONS RELATIVE TO THE MAXIMUM WIDTH TAB.
- MEASURED FROM MAXIMUM DIAMETER OF ACTUAL DEVICE.
- MINIMUM FLAT.
- TAB CENTERLINE.

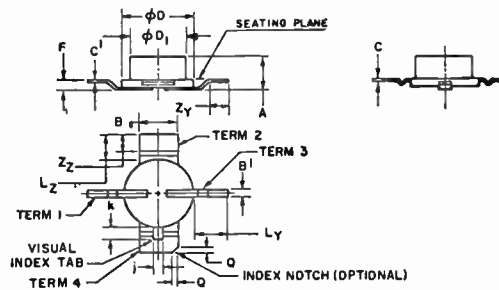

TO 113

MILLIMETER DIMENSIONS ARE DERIVED FROM BASIC INCH DIMENSIONS

SYMBOL	INCHES		MILLIMETERS		NOTES
	MIN.	MAX.	MIN.	MAX.	
A	.080	.100	2.04	2.54	
B	.095	.105	2.42	2.66	
B ₁	.012	.025	.31	.63	2
C	.001	.002	.026	.050	2
C ₁	.001	.003	.026	.076	1
B ₀	.180	.200	4.58	5.08	
B ₀₁	.157	.164	3.988	4.165	
F		.025		.63	3, 7
J		.024		.60	
K		.033		.83	4
LY	.088	.130	2.24	3.30	1, 4
LZ	.060	.080	1.53	2.03	2, 4
Q		.020		.50	
ZY	.040		1.02		1, 5, 6, 7
ZZ	.030		.77		2, 5, 6, 7

NOTES:

- TERMINALS 1 AND 3.
- TERMINALS 2 AND 4.
- ALL TERMINALS.
- MEASURED FROM MAXIMUM DIAMETER OF ACTUAL DEVICE.
- FLAT ON TERMINALS.
- WITH THE DEVICE SEATED IN A .165" (4.20 MM) + .010" (.25 MM) - .000" (.00 MM) HOLE A MAXIMUM FORCE OF 20 GRAMS ON EACH OF THE TERMINALS SHALL CAUSE THE FLATS OF THE TERMINALS TO CONTACT THE SEATING PLANE.
- TERMINAL CONFIGURATIONS OPTIONAL BETWEEN B₀ D AND FLATS ON TERMINALS.

TO 114

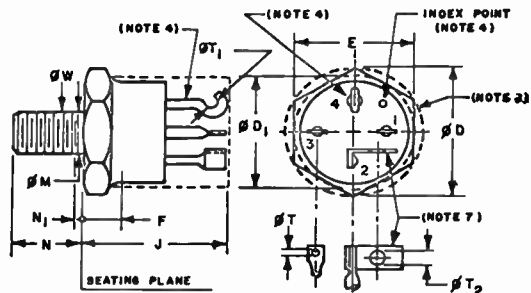

MILLIMETER DIMENSIONS ARE DERIVED FROM BASIC INCH DIMENSIONS

SYMBOL	INCHES		MILLIMETERS		NOTES
	MIN	MAX	MIN	MAX	
ϕD	—	1.227	—	31.16	
ϕD_1	.885	1.031	22.5	26.1	1
E	1.031	1.063	26.19	27.00	2
F	.090	.400	2.3	10.1	5
J	1.048	1.750	26.7	44.4	1
ϕM	.625	.500	10.80	12.70	6
N	.781	.828	19.84	21.03	
N_1	—	.156	—	3.96	6
ϕT	.078	.109	1.99	2.76	
ϕT_1	.234	.281	5.95	7.13	
ϕT_2	.180	.210	4.58	5.33	7
ϕW	.4619	.4675	11.733	11.874	8

NOTES:

1. Device body and terminals (with exception of hexagon) lie within the cylinder diameter ϕD_1 and length J.
2. Position of terminals in relation to the hexagon is not controlled.
3. Four terminals. Omission of a maximum of one terminal is optional. Position of the terminals is optional. The number and position of terminals actually present are indicated in the product registration.
4. The use of either a hook or tab terminal contour is optional. An index point is required when the tab terminal (identical to the adjacent terminals) contour option is used.
5. A chamfer (or undercut) on one or both ends of hexagonal portion is optional.
6. Incomplete or undercut threads.
7. Use of tab extension is optional.
8. Pitch diameter of $\frac{1}{8}$ -20 UNF-2A (coated) threads (ASA B1.1-1960).

TO 115

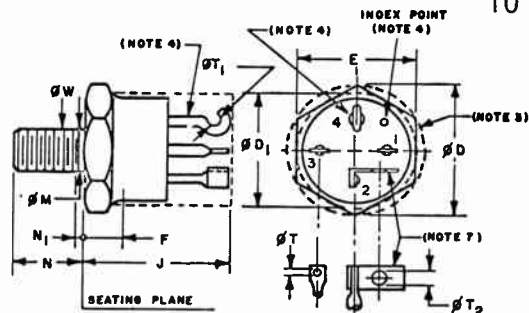

MILLIMETER DIMENSIONS ARE DERIVED FROM BASIC INCH DIMENSIONS

SYMBOL	INCHES		MILLIMETERS		NOTES
	MIN	MAX	MIN	MAX	
ϕD	—	1.443	—	36.65	
ϕD_1	1.109	1.212	28.2	30.7	1
E	1.212	1.250	30.79	31.75	2
F	.090	.400	2.3	10.1	5
J	1.313	2.250	33.4	57.1	1
ϕM	.550	.625	13.97	15.87	6
N	.922	.985	23.42	25.01	
N_1	—	.156	—	3.96	6
ϕT	.078	.109	1.99	2.76	
ϕT_1	.234	.281	5.95	7.13	
ϕT_2	.250	.281	6.35	7.13	7
ϕW	.5828	.5889	14.804	14.958	8

NOTES:

1. Device body and terminals (with exception of hexagon) lie within the cylinder diameter ϕD_1 and length J.
2. Position of terminals in relation to the hexagon is not controlled.
3. Four terminals. Omission of a maximum of one terminal is optional. Position of the terminals is optional. The number and position of terminals actually present are indicated in the product registration.
4. The use of either a hook or tab terminal contour is optional. An index point is required when the tab terminal (identical to the adjacent terminals) contour option is used.
5. A chamfer (or undercut) on one or both ends of hexagonal portion is optional.
6. Incomplete or undercut threads.
7. Use of tab extension is optional.
8. Pitch of diameter of $\frac{5}{8}$ -18 UNF-2A (coated) threads (ASA B1.1-1960).

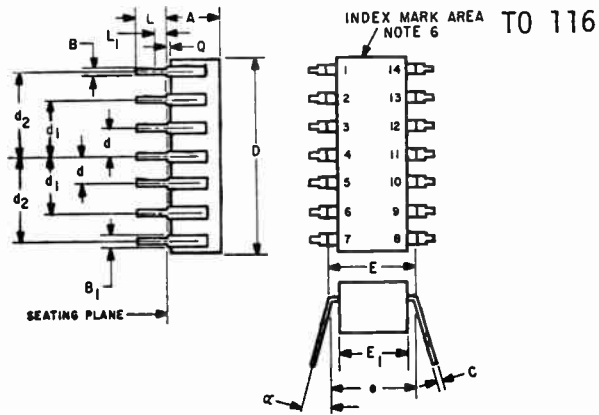

MILLIMETER DIMENSIONS ARE DERIVED FROM BASIC INCH DIMENSIONS

SYMBOL	INCHES		MILLIMETERS		NOTES
	MIN.	MAX.	MIN.	MAX.	
A	-	.200	-	5.08	
B	.015	.023	.381	.584	3, 7
B ₁	.030	.070	.77	1.77	3, 7
C	.008	.015	.204	.381	3
O	.660	.785	17.4	19.9	1
d	.090	.110	2.29	2.79	1
d ₁	.190	.210	4.83	5.33	1
d ₂	.290	.310	7.37	7.87	1
E	-	.325	-	8.25	5
E ₁	.220	.280	5.59	7.11	
e	.290	.310	7.37	7.87	4
L	.100	-	2.540	-	1, 3
L ₁	-	.030	-	.76	2
Q	.020	-	.51	-	
α	0°	15°	0°	15°	

NOTES:

- LEADS MISSING FROM THEIR DESIGNATED POSITIONS SHALL BE COUNTED WHEN NUMBERING LEADS FOR SPECIAL APPLICATIONS.
- LEAD SPACING SHALL BE MEASURED WITHIN THIS ZONE.
- TYPICAL ALL LEADS.
- INSTALLED POSITION OF LEAD CENTERS.
- OVERALL INSTALLED WIDTH.
- INDEX TO BE VISIBLE FROM TOP, THIS END ONLY.
- LEAD TRANSITION GEOMETRY FROM B TO B₁ OPTIONAL ON BODY SIDE OF SEATING PLANE.

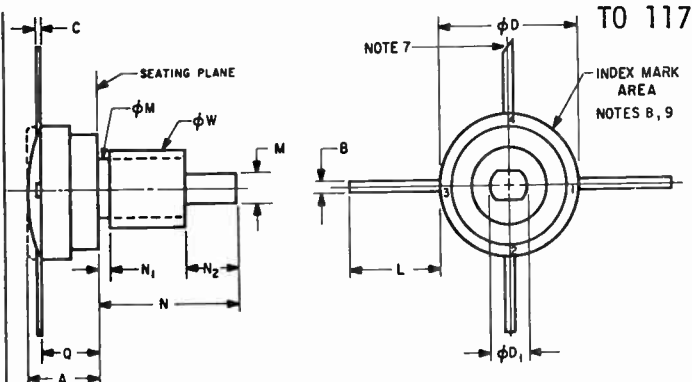

MILLIMETER DIMENSIONS DERIVED FROM BASIC INCH DIMENSIONS

SYMBOL	INCHES		MILLIMETERS		NOTES
	MIN.	MAX.	MIN.	MAX.	
A	.140	.230	3.56	5.84	1
B	.027	.033	.686	.838	2
C	.014	.016	.356	.406	1
ØD	.240	.380	6.1	9.6	3
ØD ₁	.110	.129	2.80	3.27	2, 4
L	.450	-	11.43	-	3
M	.055	.065	1.40	1.65	3
ØM	.120	.163	3.05	4.14	5
N	.425	.525	10.8	13.3	-
N ₁	-	.078	-	1.98	5
N ₂	.115	.145	2.93	3.68	3
Q	.110	.130	2.80	3.30	-
ØW	.1399	.1437	3.554	3.649	6

NOTES:

- BODY CONTOUR OPTIONAL WITHIN ØD AND A.
- TYPICAL ALL LEADS.
- ORIENTATION OF FLATS NOT CONTROLLED IN RELATION TO THE LEADS.
- OMISSION OF ONE LEAD OPTIONAL. THE NUMBER AND POSITION OF LEADS ACTUALLY PRESENT ARE INDICATED IN THE PRODUCT REGISTRATIONS.
- LENGTH (OR DIAMETER) OF INCOMPLETE OR UNDERCUT THREADS.
- PITCH DIAMETER OF 8-32 UNC-2A (COATED) THREADS (ASA B1.1-1960).
- LEAD 4 END CONFIGURATION OPTIONAL.
- INDEX MARK TO BE VISIBLE FROM TOP.
- INDEX MARK OPTIONAL FOR THREE-LEAD DEVICES.

TO 118

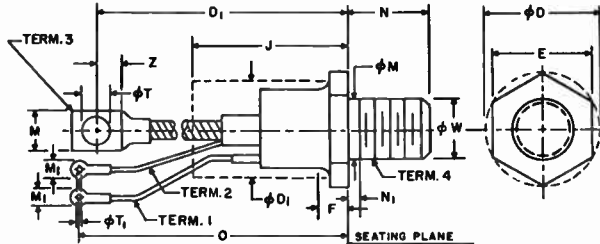

MILLIMETER DIMENSIONS ARE DERIVED FROM BASIC INCH DIMENSIONS

SYMBOL	INCHES		MILLIMETERS		NOTES
	MIN.	MAX.	MIN.	MAX.	
ϕD	-	1.949	-	49.50	-
ϕD_1	-	1.631	-	41.42	1
E	1.631	1.688	41.43	42.87	-
F	.250	.500	6.4	12.7	5
J	-	4.000	-	101.60	1,7
M	.735	1.000	18.7	25.4	2
N_1	.260	.328	6.61	8.33	2,8
ϕM	.660	.749	16.77	19.02	-
N	1.031	1.095	26.19	27.81	-
N_2	-	.156	-	3.96	3
O	9.640	10.140	244.9	257.5	-
O_1	9.400	9.780	238.6	248.4	-
ϕT	.320	.448	8.2	11.3	-
ϕT_1	.140	.172	3.56	4.36	-
ϕW	.7029	.7094	17.854	18.018	4
Z	.375	-	9.53	-	6

NOTES:

1. THE BODY OF THE DEVICE WITH EXCEPTION OF THE HEXAGON, THREAD, AND FLEXIBLE LEAD EXTENSIONS LIES WITHIN ϕD_1 AND LENGTH J.
2. ANGULAR ORIENTATION OF THESE TERMINALS WITH RESPECT TO HEXAGON PORTION IS UNDEFINED. SQUARE OR RADIUS ON END OF TERMINALS IS OPTIONAL.
3. LENGTH OF INCOMPLETE OR UNDERCUT THREADS OF ϕM
4. PITCH DIAMETER OF 3/4-16 UNF-2A (COATED) THREADS (ASA B1.1-1960)
5. A CHAMFER (OR UNDERCUT) ON ONE OR BOTH ENDS OF HEXAGON PORTION IS OPTIONAL.
6. MINIMUM FLAT.
7. SEATED HEIGHT WITH LEAD BENT AT RIGHT ANGLES.
8. FLEXIBLE LEADS FOR TERMINALS 1 AND 2 ARE IDENTIFIED BY COLOR CODING FOR SPECIFIC APPLICATIONS.

TO 119

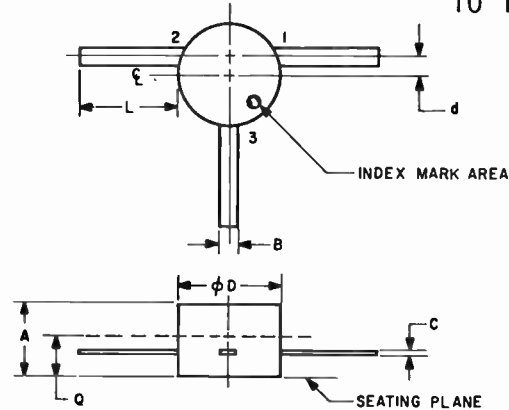

MILLIMETER DIMENSIONS DERIVED FROM BASIC INCH DIMENSIONS

SYMBOL	INCHES		MILLIMETERS		NOTES
	MIN.	MAX.	MIN.	MAX.	
A	.040	.065	1.02	1.65	1
B	.020	.028	.508	.711	2
C	.003	.005	.077	.127	2
ϕD	.184	.225	4.68	5.71	1
d	-	.035	-	.88	3
L	.240	-	6.10	-	2,4
Q	-	.030	-	.76	3

NOTES:

1. CONTOUR OF BODY OPTIONAL WITHIN ϕD AND A. ϕD MIN. AND ϕD MAX. APPLY ONLY TO GREATEST BODY DIAMETER.
2. TYPICAL ALL LEADS.
3. LEADS SHALL EMERGE FROM THE BODY WITHIN THE LIMITS INDICATED BY THE d AND Q DIMENSIONS.
4. MEASURED FROM GREATEST BODY DIAMETER OF ACTUAL DEVICE.

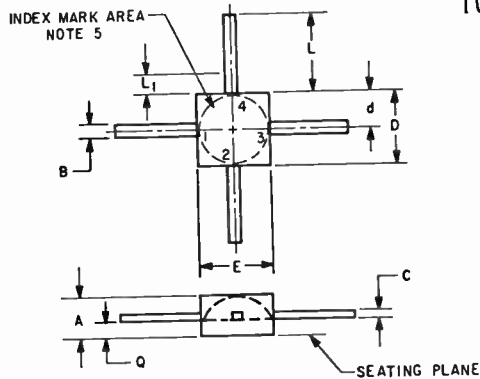

TO 120

MILLIMETER DIMENSIONS ARE DERIVED FROM ORIGINAL INCH DIMENSIONS

SYMBOL	INCHES		MILLIMETERS		NOTES
	MIN.	MAX.	MIN.	MAX.	
A	.030	.062	.77	1.57	1
B	.008	.019	.21	.48	2
C	.003	.007	.077	.177	2
d	.015	.046	.39	1.16	3
D	.067	.092	1.71	2.33	1
E	.067	.088	1.71	2.23	1
L	.100	-	2.54	-	2
L1	-	.035	-	.88	2, 4
Q	.007	.034	.18	.86	-

NOTES:

1. CONFIGURATION OF PACKAGE OPTIONAL WITHIN ZONE DEFINED BY A, D, AND E.
2. TYPICAL ALL LEADS.
3. THIS DIMENSION APPLIES TO LEADS 1 AND 3 ONLY.
4. LEAD DIMENSIONS NOT CONTROLLED IN THIS ZONE TO ALLOW FOR BODY AND LEAD FINISH IRREGULARITIES.
5. INDEX TO BE VISIBLE FROM TOP.
6. OMISSION OF ONE LEAD OPTIONAL. LEADS MISSING FROM THEIR DESIGNATED POSITIONS SHALL BE COUNTED WHEN NUMBERING LEADS FOR SPECIFIC APPLICATIONS. THE NUMBER AND POSITION OF LEADS ACTUALLY PRESENT ARE INDICATED IN THE PRODUCT REGISTRATION.

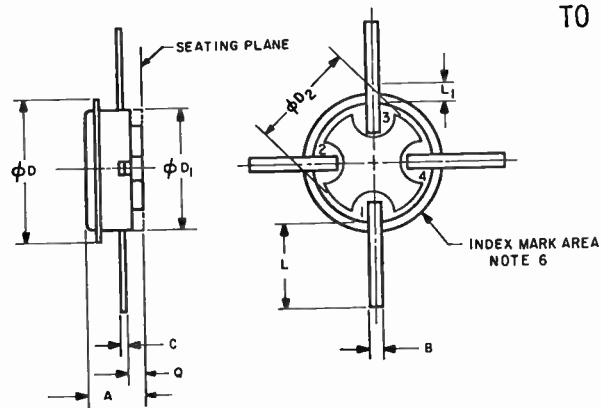

TO 121

MILLIMETER DIMENSIONS DERIVED FROM BASIC INCH DIMENSIONS

SYMBOL	INCHES		MILLIMETERS		NOTES
	MIN.	MAX.	MIN.	MAX.	
A	.145	.200	3.69	5.08	-
B	.035	.046	.89	1.16	1
C	.012	.019	.305	.482	1
ϕD	.593	.680	15.07	17.27	-
ϕD_1	.520	.594	13.21	15.08	2
ϕD_2	.480	-	12.20	-	3
L	.195	-	4.96	-	1, 4
L1	-	.105	-	2.66	1, 4, 5
Q	.005	.020	.13	.50	2

NOTES:

1. TYPICAL ALL LEADS.
2. CONFIGURATION OF PACKAGE OPTIONAL WITHIN ZONE DEFINED BY ϕD_1 AND Q.
3. MINIMUM DIAMETER OF SEATING PLANE.
4. MEASURED FROM INTERSECTION OF LEAD AXIS AND BODY SURFACE OF DIAMETER ϕD_1 .
5. DIMENSIONS, CONFIGURATION, AND POSITION OF LEADS OPTIONAL IN THIS ZONE.
6. INDEX MARK OPTIONAL FOR THREE-LEAD DEVICES.
7. OMISSION OF ONE LEAD OPTIONAL. THE NUMBER AND POSITION OF LEADS ACTUALLY PRESENT ARE INDICATED IN THE PRODUCT REGISTRATION.

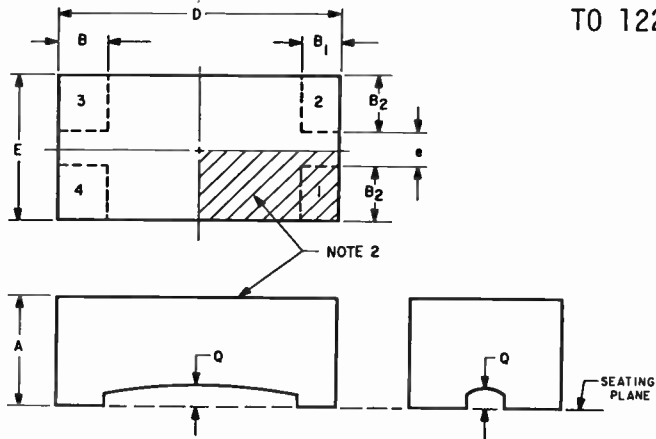

MILLIMETER DIMENSIONS ARE DERIVED FROM BASIC INCH DIMENSIONS

SYMBOL	INCHES		MILLIMETERS		NOTES
	MIN.	MAX.	MIN.	MAX.	
A	0.027	0.035	0.686	0.889	-
B	0.011	0.017	0.280	0.431	-
B ₁	0.008	0.014	0.204	0.355	-
B ₂	0.012	0.018	0.305	0.457	3
D	0.070	0.078	1.778	1.981	-
E	0.035	0.043	0.889	1.092	-
e	0.009	0.011	0.229	0.279	3
Q	-	-	-	-	1

NOTES:

1. DETAILS OF THE OUTLINE IN THIS ZONE ARE OPTIONAL EXCEPT THAT THE OUTLINE SHALL NOT EXTEND BEYOND THE SEATING PLANE.
2. AN INDEX MARK SHALL BE LOCATED ON THE TOP SURFACE IN THE QUADRANT ABOVE TERMINAL ONE.
3. THESE TOLERANCES ARE NON-CUMULATIVE.

TO 122

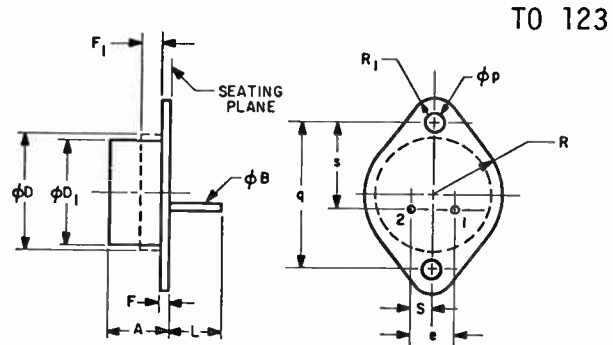

MILLIMETER DIMENSIONS ARE DERIVED FROM BASIC INCH DIMENSIONS

SYMBOL	INCHES		MILLIMETERS		NOTES
	MIN.	MAX.	MIN.	MAX.	
A	.250	.340	6.35	8.63	-
ϕB	.028	.034	.712	.863	-
ϕD	-	.620	-	15.74	1
ϕD_1	.470	.500	11.94	12.70	-
e	.190	.210	4.83	5.33	-
F	.020	.040	.51	1.01	2
F ₁	-	.050	-	1.27	1
L	.360	-	9.15	-	-
ϕP	.142	.152	3.61	3.86	-
q	.958	.962	24.334	24.434	-
R	-	.352	-	8.94	-
R ₁	-	.147	-	3.73	-
S	.093	.107	2.37	2.71	-
s	.570	.590	14.48	14.98	-

NOTES:

1. OUTLINE CONTOUR OPTIONAL WITHIN ZONE DEFINED BY ϕD AND F₁.
2. THE F DIMENSION DOES NOT INCLUDE SEALING FLANGES.

TO 123

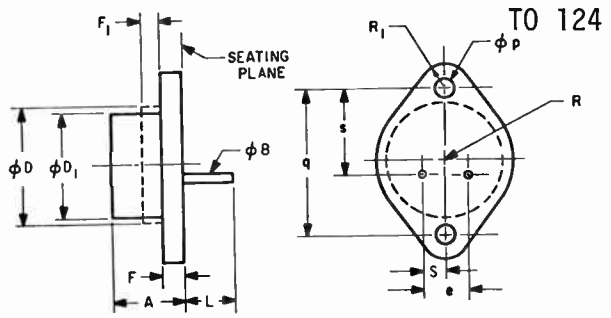

MILLIMETER DIMENSIONS ARE DERIVED FROM BASIC INCH DIMENSIONS

SYMBOL	INCHES		MILLIMETERS		NOTES
	MIN.	MAX.	MIN.	MAX.	
A	.250	.355	6.4	9.0	-
ØB	.028	.034	.712	.863	-
ØD	-	.620	-	15.74	1
ØD1	.470	.500	11.94	12.70	-
e	.190	.210	4.83	5.33	-
F	.085	.102	2.16	2.59	2
F1	-	.050	-	1.27	1
L	.360	-	9.15	-	-
ØP	.142	.152	3.61	3.86	-
q	.958	.962	24.334	24.434	-
R	-	.352	-	8.94	-
R1	-	.147	-	3.73	-
S	.093	.107	2.37	2.71	-
s	.570	.590	14.48	14.98	-

NOTES:

1. OUTLINE CONTOUR OPTIONAL WITHIN ZONE DEFINED BY ØD AND F1.
2. THE F DIMENSION DOES NOT INCLUDE SEALING FLANGES.

TO 125

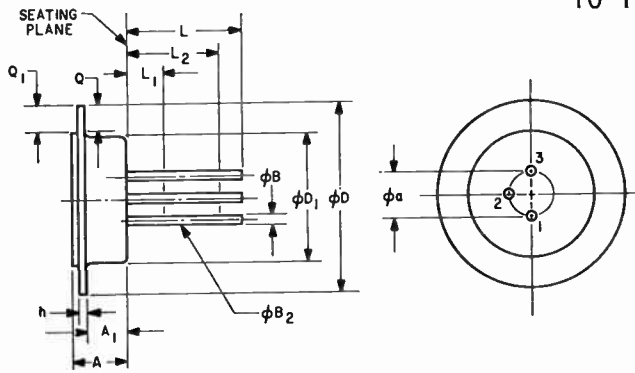

MILLIMETER DIMENSIONS ARE DERIVED FROM BASIC INCH DIMENSIONS

SYMBOL	INCHES		MILLIMETERS		NOTES
	MIN.	MAX.	MIN.	MAX.	
A	.099	.123	2.52	3.12	-
Øa	.100 T.P.	-	2.54 T.P.	-	2
ØB	.016	.021	.407	.533	1
ØB2	.016	.019	.407	.482	1
ØD	.427	.433	10.846	10.998	-
ØD1	.284	.290	7.214	7.366	-
h	.008	.012	.204	.304	-
L	.450	-	11.43	-	1
L1	-	.050	-	1.27	1
L2	.250	-	6.35	-	1
Q	.058	-	1.48	-	3
Q1	.032	-	.82	-	3
A1	.085	.101	2.16	2.56	-

NOTES:

1. ØB2 APPLIES BETWEEN L1 AND L2. ØB APPLIES BETWEEN L2 AND L. DIAMETER IS NOT CONTROLLED IN L1.
2. THE CROSS SECTION OF EACH LEAD HAVING A MAXIMUM DIAMETER OF .019" (.482 MM) AND MEASURED IN A GAGING PLANE .054" (1.372 MM) + .001" (.025 MM) - .000" (.000 MM) BELOW THE SEATING PLANE LIES IN A CIRCLE HAVING A DIAMETER OF .033" (.838 MM) CENTERED AT THE TRUE POSITION OF THE LEAD AXIS AT ITS POINT OF EXIT RELATIVE TO A .290" (7.366 MM) MAXIMUM BODY DIAMETER, ØD1.
3. MINIMUM FLAT.

TO 126

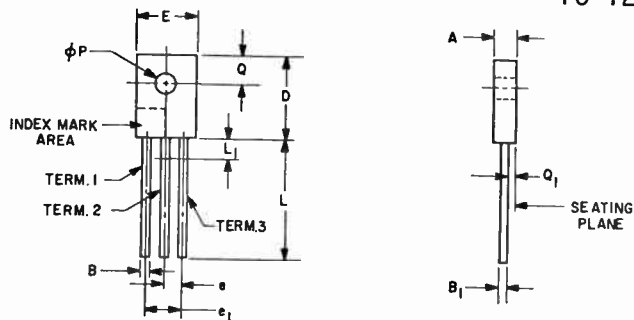

MILLIMETER DIMENSIONS ARE DERIVED FROM ORIGINAL INCH DIMENSIONS

SYMBOL	INCHES		MILLIMETERS		NOTES
	MIN.	MAX.	MIN.	MAX.	
A	.090	.120	2.29	3.04	-
B	.025	.035	.64	.88	4
B ₁	.015	.025	.39	.63	-
D	.400	.450	10.16	11.43	-
E	.280	.330	7.12	8.38	-
e	.080	.100	2.04	2.54	3
e ₁	.160	.200	4.07	5.08	3
L	.595	.655	15.12	16.63	-
L ₁	-	.100	-	2.54	1
phi P	.100	.130	2.54	3.30	-
Q	.130	.175	3.31	4.44	-
Q ₁	.035	.065	.89	1.65	-

NOTES:

- LEAD DIMENSIONS NOT CONTROLLED IN THIS ZONE TO ALLOW FOR BODY FLASH AND LEAD FINISH BUILD-UP.
- MAXIMUM RADIUS OF .050 IN. (1.27 MM) ON ALL BODY EDGES AND CORNERS.
- LEAD SPACING TO BE MEASURED BETWEEN .100 IN. (2.54 MM) AND .125 IN. (3.17 MM) FROM THE POINT OF EMERGENCE FROM THE BODY.
- TYPICAL ALL LEADS.

TO 127

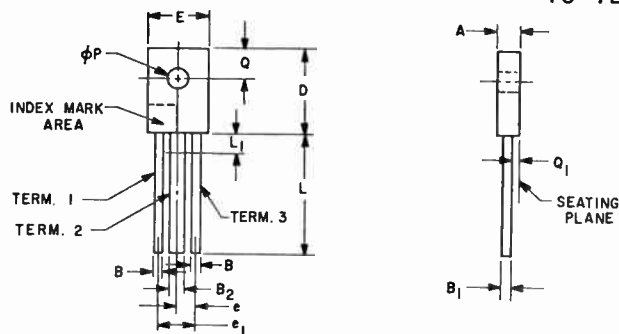

MILLIMETER DIMENSIONS ARE DERIVED FROM ORIGINAL INCH DIMENSIONS

SYMBOL	INCHES		MILLIMETERS		NOTES
	MIN.	MAX.	MIN.	MAX.	
A	.120	.150	3.05	3.81	-
B	.041	.051	1.05	1.29	-
B ₁	.027	.037	.69	.93	-
B ₂	.065	.075	1.66	1.90	-
D	.618	.668	15.70	16.96	-
E	.480	.530	12.20	13.46	-
e	.151	.181	3.84	4.59	3
e ₁	.302	.362	7.68	9.19	3
L	.595	.655	15.12	16.63	-
L ₁	-	.125	-	3.17	1
phi P	.125	.155	3.18	3.93	-
Q	.180	.225	4.58	5.71	-
Q ₁	.035	.065	.89	1.65	-

NOTES:

- LEAD DIMENSIONS NOT CONTROLLED IN THIS ZONE TO ALLOW FOR BODY FLASH AND LEAD FINISH BUILD-UP.
- MAXIMUM RADIUS OF .050 IN. (1.27 MM) ON ALL BODY EDGES AND CORNERS.
- LEAD SPACING TO BE MEASURED BETWEEN .125 IN. (3.18 MM) AND .150 IN. (3.81 MM) FROM THE POINT OF EMERGENCE FROM THE BODY.

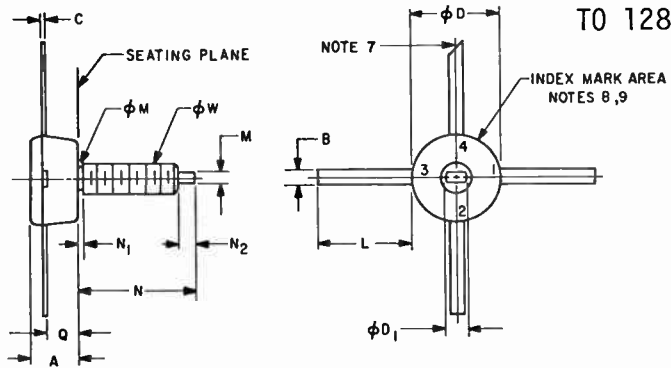

TO 128

MILLIMETER DIMENSIONS ARE DERIVED FROM ORIGINAL INCH DIMENSIONS

SYMBOL	INCHES		MILLIMETERS		NOTES
	MIN.	MAX.	MIN.	MAX.	
A	.280	.285	7.112	7.239	1
B	.088	.092	2.236	2.336	2
C	.014	.016	.356	.406	2
φD	.450	.500	11.43	12.70	1
φD1	.100	.120	2.54	3.04	3
L	.480	.500	12.20	12.70	2
M	.056	.064	1.423	1.625	3
φM	.120	.163	3.05	4.14	-
N	.440	.460	11.18	11.68	-
N1	-	.078	-	1.98	5
N2	.115	.145	2.93	3.68	3
Q	.160	.170	4.07	4.31	-
φW	.1399	.1437	3.554	3.649	6

NOTES:

1. BODY CONTOUR OPTIONAL WITHIN φD AND A. φD MIN. APPLIES TO GREATEST BODY DIAMETER.
2. TYPICAL ALL LEADS.
3. ORIENTATION OF FLATS NOT CONTROLLED IN RELATION TO THE LEADS.
4. OMISSION OF ONE LEAD OPTIONAL. THE NUMBER AND POSITION OF LEADS ACTUALLY PRESENT ARE INDICATED IN THE PRODUCT REGISTRATIONS.
5. LENGTH OF INCOMPLETE OR UNDERCUT THREADS OF φM.
6. PITCH DIAMETER OF 8-32 UNC-2A (COATED) THREADS (ASA B1.1-1960).
7. LEAD 4 END CONFIGURATION OPTIONAL.
8. INDEX MARK TO BE VISIBLE FROM TOP.
9. INDEX MARK OPTIONAL FOR THREE-LEAD DEVICES.

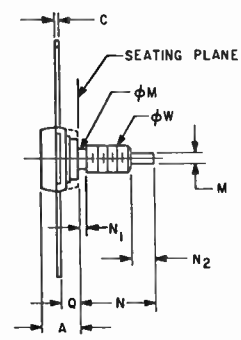

TO 129

MILLIMETER DIMENSIONS ARE DERIVED FROM ORIGINAL INCH DIMENSIONS

SYMBOL	INCHES		MILLIMETERS		NOTES
	MIN.	MAX.	MIN.	MAX.	
A	.200	.230	5.08	5.84	1
B	.285	.295	7.24	7.49	-
B1	.028	.032	.712	.812	-
C	.010	.012	.254	.304	2
φD	.365	.370	9.271	9.398	1
φD1	.110	.129	2.80	3.27	3
L	.430	.440	10.93	11.17	-
L1	-	.550	-	13.97	-
M	.056	.064	1.423	1.625	3
φM	.120	.163	3.05	4.14	-
N	.440	.460	11.18	11.68	-
N1	-	.078	-	1.98	4
N2	.115	.145	2.93	3.68	3
Q	.110	.130	2.80	3.30	-
φW	.1399	.1437	3.554	3.649	5

NOTES:

1. BODY CONTOUR OPTIONAL WITHIN φD AND A. φD MIN. APPLIES TO GREATEST BODY DIAMETER.
2. TYPICAL ALL LEADS.
3. ORIENTATION OF FLATS NOT CONTROLLED IN RELATION TO THE LEADS.
4. LENGTH OF INCOMPLETE OR UNDERCUT THREADS OF φM.
5. PITCH DIAMETER OF 8-32 UNC-2A (COATED) THREADS (ASA B1.1-1960).
6. INDEX MARK TO BE VISIBLE FROM TOP.
7. LEAD END CONFIGURATION OPTIONAL.

TO 130

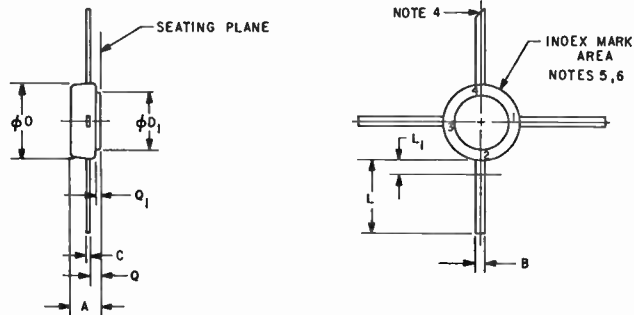

MILLIMETER DIMENSIONS ARE DERIVED FROM ORIGINAL INCH DIMENSIONS

SYMBOL	INCHES		MILLIMETERS		NOTES
	MIN.	MAX.	MIN.	MAX.	
A	.170	.180	4.32	4.57	1
B	.028	.032	.712	.812	2
C	.014	.016	.356	.406	2
Ø0	.400	.455	10.16	11.55	1
Ø01	.320	.330	8.13	8.38	-
L	.475	.525	12.07	13.33	2,3
L1	-	.035	-	.88	2,7
Q	.055	-	1.40	-	-
Q1	.005	.020	.13	.50	-

NOTES:

1. BODY CONTOUR OPTIONAL WITHIN Ø0 AND A. Ø0 MIN. APPLIES TO GREATEST BODY DIAMETER.
2. TYPICAL ALL LEADS.
3. OMISSION OF ONE LEAD OPTIONAL. THE NUMBER AND POSITION OF LEADS ACTUALLY PRESENT ARE INDICATED IN THE PRODUCT REGISTRATIONS.
4. LEAD 4 END CONFIGURATION OPTIONAL.
5. INOX MARK TO BE VISIBLE FROM TOP.
6. INOX MARK OPTIONAL FOR THREE-LEAD DEVICES.
7. LEAD DIMENSIONS NOT CONTROLLED IN THIS ZONE TO ALLOW FOR BODY AND LEAD FINISH IRREGULARITIES.

TO 131

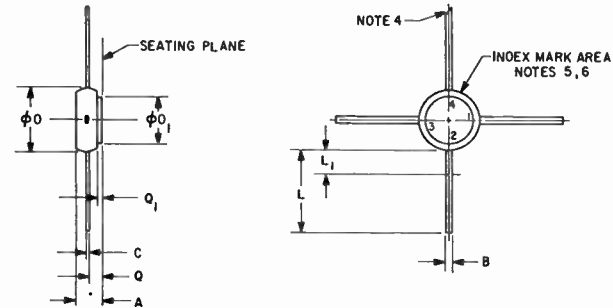

MILLIMETER DIMENSIONS ARE DERIVED FROM ORIGINAL INCH DIMENSIONS

SYMBOL	INCHES		MILLIMETERS		NOTES
	MIN.	MAX.	MIN.	MAX.	
A	.145	.185	3.69	4.69	1
B	.028	.032	.712	.812	2
C	.014	.016	.356	.406	2
Ø0	.355	.375	9.02	9.52	1
Ø01	.270	.285	6.86	7.23	-
L	.450	.550	11.5	13.9	2,3
L1	-	.035	-	.88	2,7
Q	.055	-	1.40	-	-
Q1	.005	.020	.13	.50	-

NOTES:

1. BODY CONTOUR OPTIONAL WITHIN Ø0 AND A. Ø0 MIN APPLIES TO GREATEST BODY DIAMETER.
2. TYPICAL ALL LEADS.
3. OMISSION OF ONE LEAD OPTIONAL. THE NUMBER AND POSITION OF LEADS ACTUALLY PRESENT ARE INDICATED IN THE PRODUCT REGISTRATIONS.
4. LEAD 4 END CONFIGURATION OPTIONAL.
5. INOX MARK TO BE VISIBLE FROM TOP.
6. INOX MARK OPTIONAL FOR THREE-LEAD DEVICES.
7. LEAD DIMENSIONS NOT CONTROLLED IN THIS ZONE TO ALLOW FOR BODY AND LEAD FINISH IRREGULARITIES.

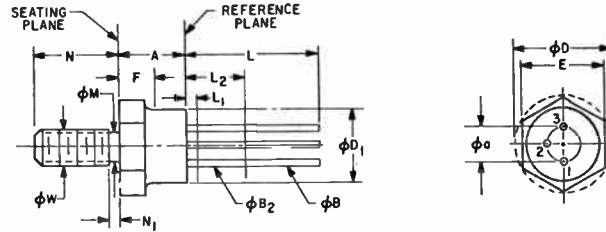

MILLIMETER DIMENSIONS ARE DERIVED FROM ORIGINAL INCH DIMENSIONS

SYMBOL	INCHES		MILLIMETERS		NOTES
	MIN.	MAX.	MIN.	MAX.	
A	.300	.350	7.62	8.89	-
β_a	.200	T.P.	5.08	T.P.	1
β_B	.016	.021	.407	.533	2
β_{B2}	.016	.019	.407	.482	2
β_D	.400	.505	10.2	12.8	-
β_{D1}	.390	.410	9.91	10.41	-
F	.423	.438	10.75	11.12	-
L	.120	.150	3.05	3.81	-
L1	.475	-	12.07	-	2
L2	-	.050	-	1.27	2
L2	.250	-	6.35	-	2
β_M	.163	.189	4.15	4.80	6
N	.422	.453	10.72	11.50	-
N1	-	.078	-	1.98	6
β_W	.1658	.1697	4.212	4.310	3

NOTES:

- LEADS SHALL BE LOCATED RELATIVE TO EACH OTHER SUCH THAT THE CROSS SECTION OF EACH LEAD HAVING A MAXIMUM DIAMETER OF .019" (.482 MM) AND MEASURED IN A GAGING PLANE .054" (1.372 MM) + .001" (.025 MM) - .000" (.000 MM) ABOVE THE REFERENCE PLANE LIES IN A CIRCLE HAVING A DIAMETER OF .033" (.84 MM) CENTERED AT THE TRUE POSITION OF THE LEAD AXIS AT ITS POINT OF EXIT. POSITION OF LEAD GROUPING IN RELATION TO THE BODY IS NOT CONTROLLED.
- (ALL LEADS) DIAMETER IS NOT CONTROLLED IN L1 AND BEYOND L. β_{B2} APPLIES BETWEEN L1 AND L2. β_B APPLIES BETWEEN L2 AND L.
- PITCH DIAMETER OF 10-32 UNF-2A (COATED) THREADS. (ASA B1.1-196D).
- ORIENTATION OF LEAD GROUPING IN RELATION TO THE HEXAGON IS NOT CONTROLLED.
- A CHAMFER (OR UNDERCUT) ON ONE OR BOTH ENDS OF HEXAGONAL PORTION IS OPTIONAL.
- LENGTH OF INCOMPLETE OR UNDERCUT THREADS OF β_W .

Transistor Outlines

The outlines for transistors that do not have TO numbers are given in this section. They are listed with a number and a letter, such as 210A. The number "210" corresponds to the one used in the Lead and Terminal Identification section. Since there are a number of different physical shapes that have the same lead or terminal arrangement, a number is used to refer to the terminals (210), and a letter (A, B, C, etc.) is used to designate the particular outline drawing.

For additional information relating to outline drawings, refer to Registered Transistor Outlines, page 96.

NOTE: Outline dimensions are in INCHES.

1A

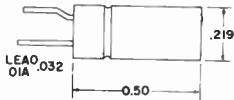

5A

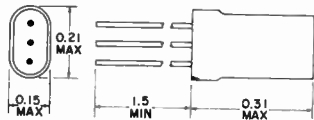

5B

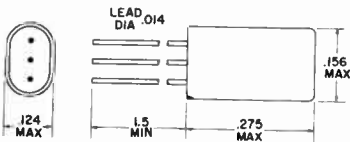

5C

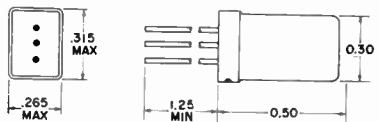

5D



5X

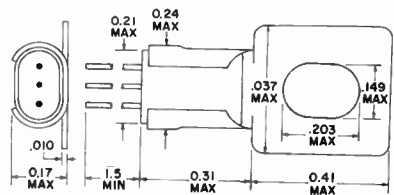

8A

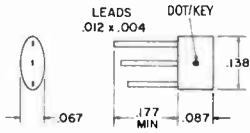

8B

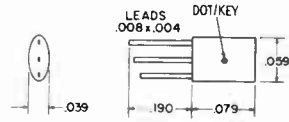

10A

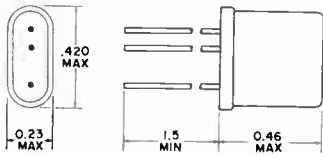

10B

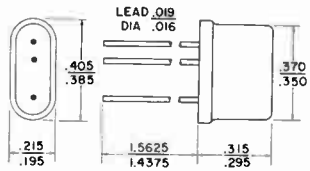

10D

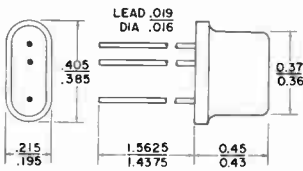

10E

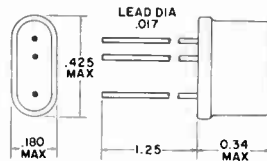

10F

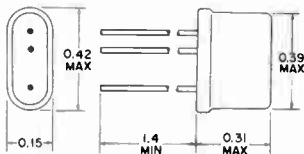

10G

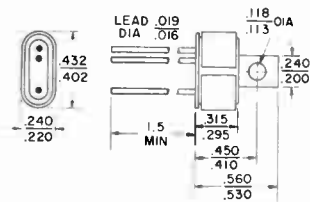

12A

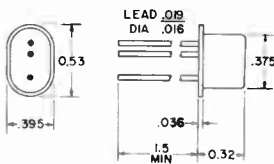

12B

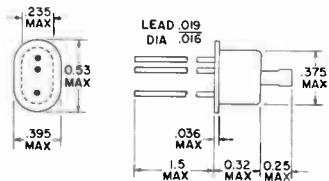

12C

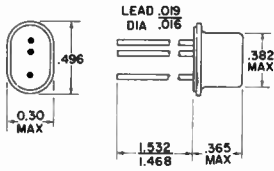

31A

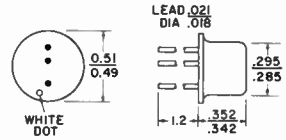

35B

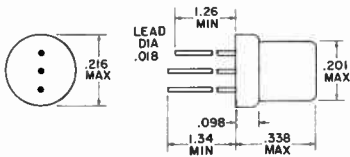

35C

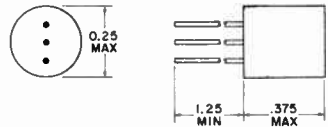

35D

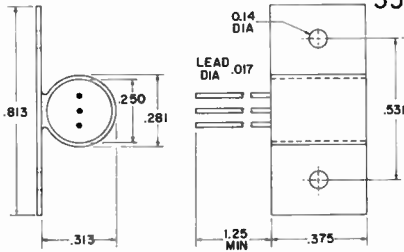

35E

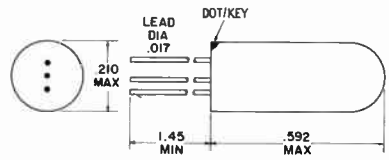

42A

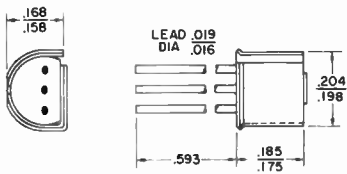

43A

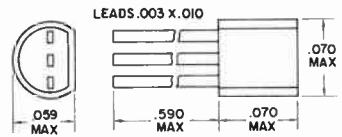

43B

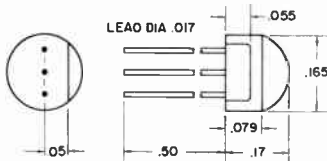

45B

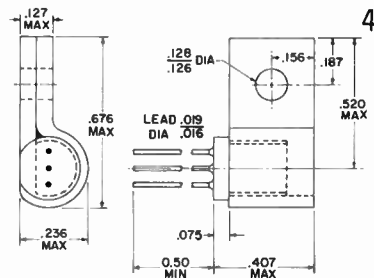

45C

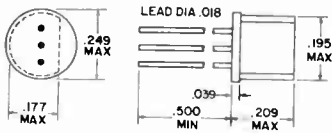

47A

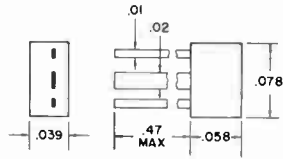

48A

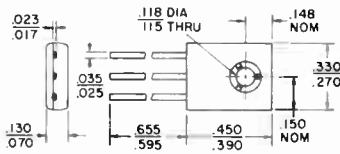

48B

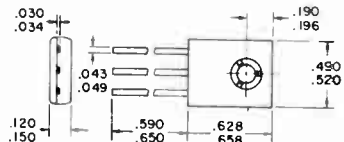

49A

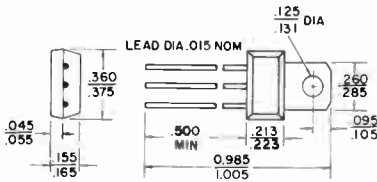

50A

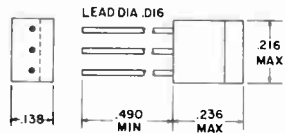

50B

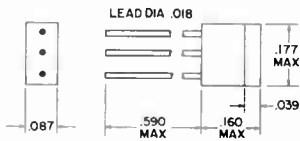

50C

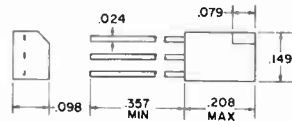

51A

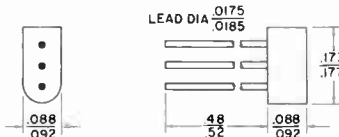

52A

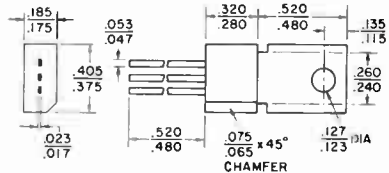

53A

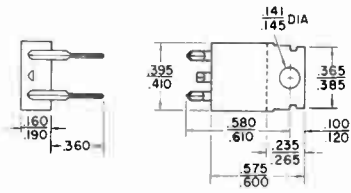

54A

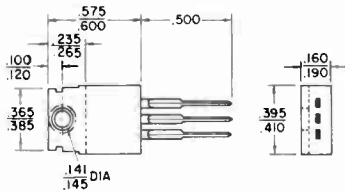

54B

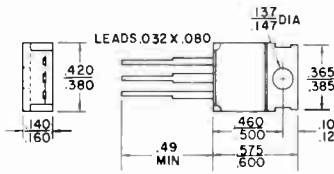

54C

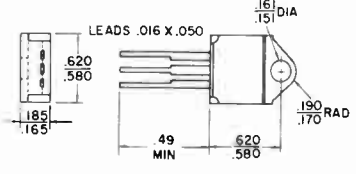

55A

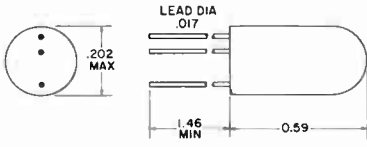

55B

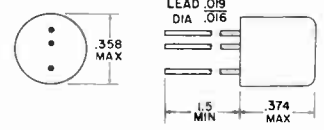

55C

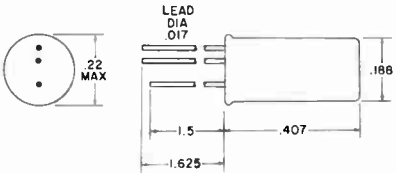

55D

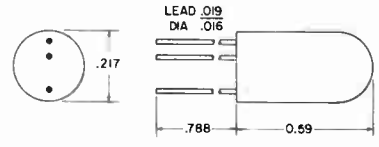

55E

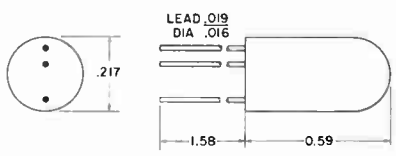

55F

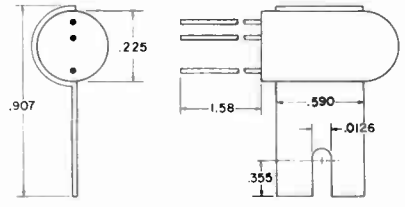

57B

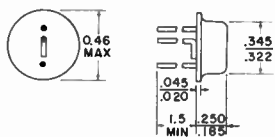

57C

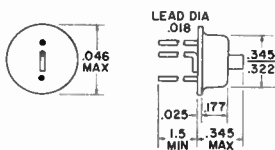

60A

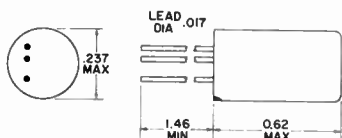

75A

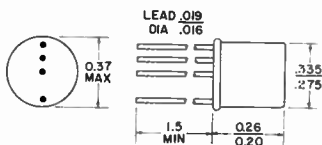

80A

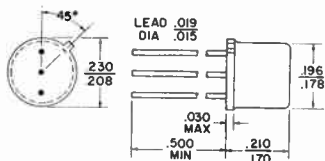

100B

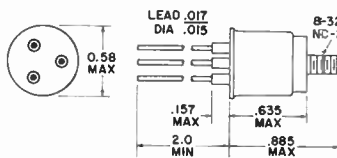

105A

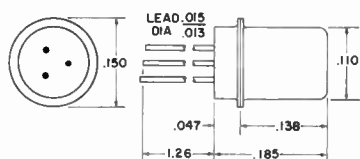

105B

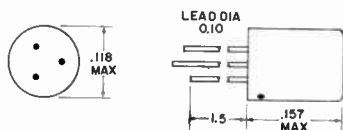

105E

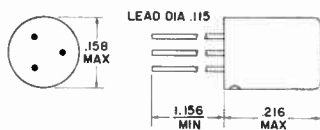

110A

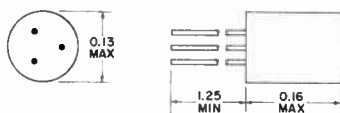

110B

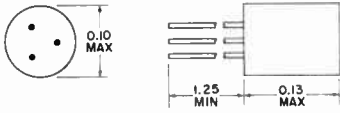

117A

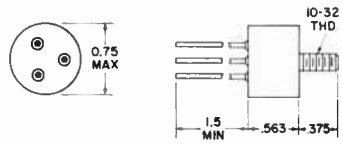

120F

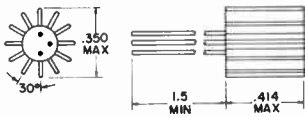

120G

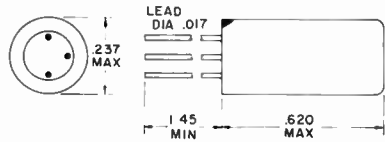

120H

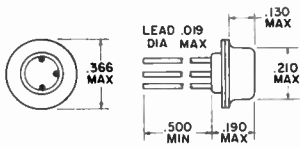

120J

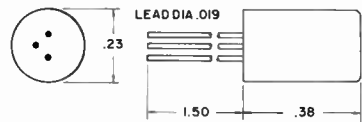

120K

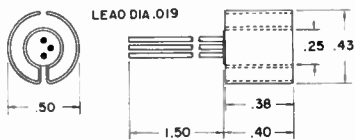

132A

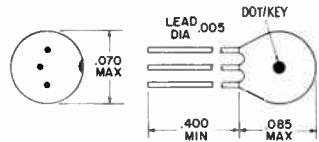

133A

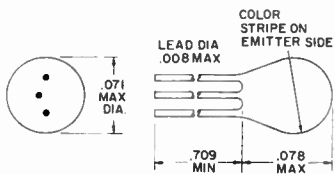

146C

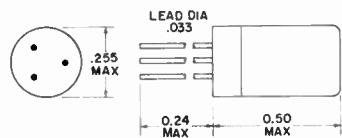

148A

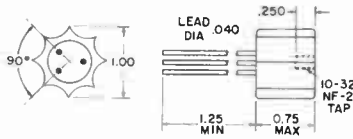

148B

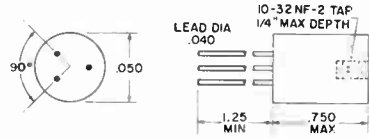

168A

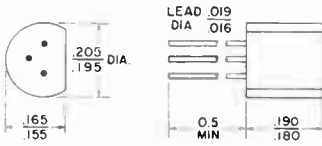

168B

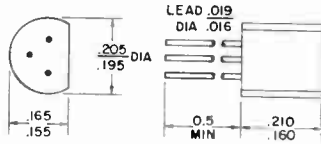

169B

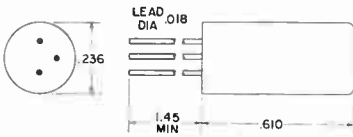

170A

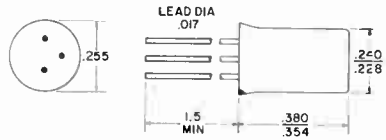

170B

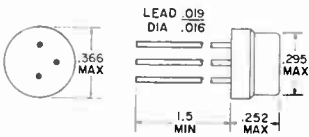

170E

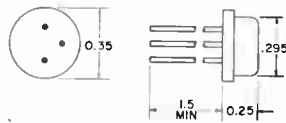

170F

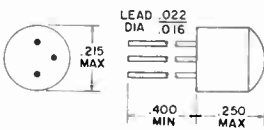

170G

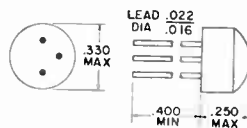

170H

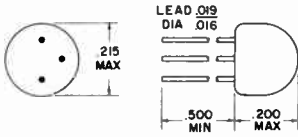

170J

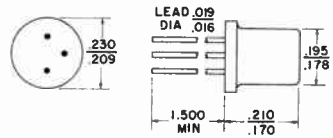

170K

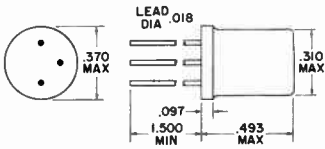

171A

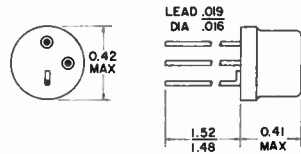

171D

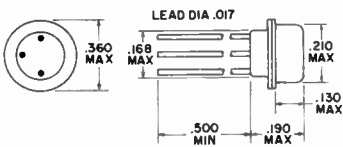

171L

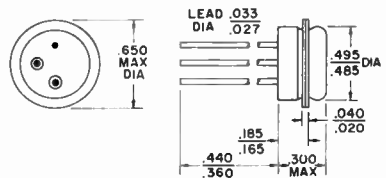

171S

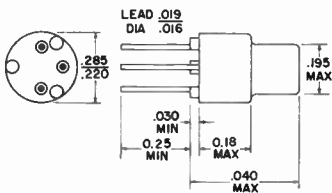

172A

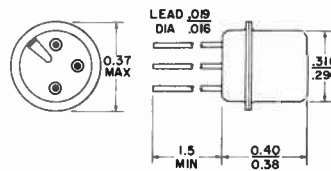

172D

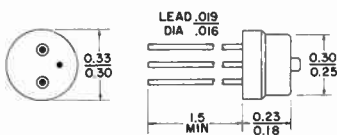

172E

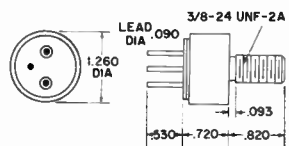

173A

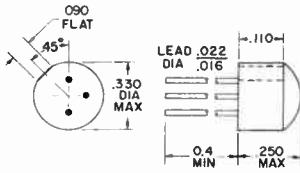

176E

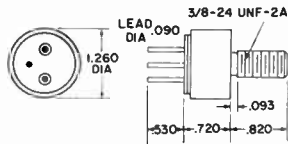

181A

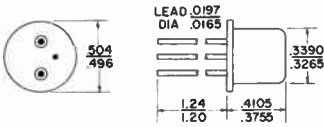

185A

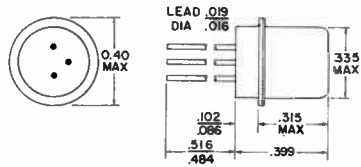

193A

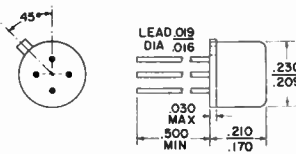

210A

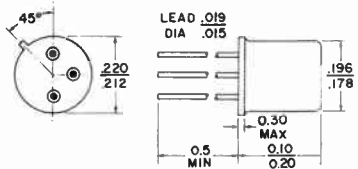

210B

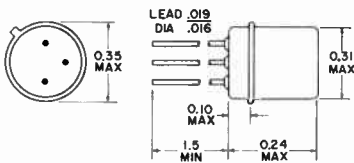

210C

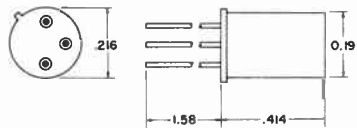

210D

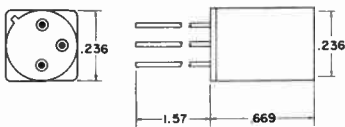

210G

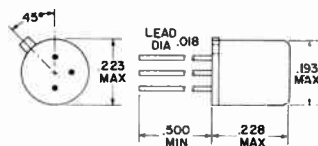

210H

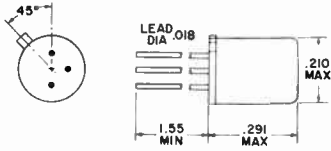

210J

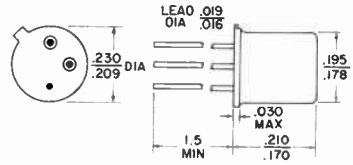

210K

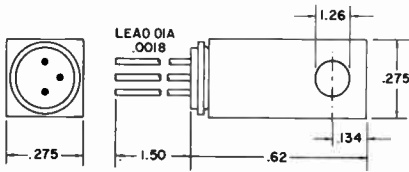

211A

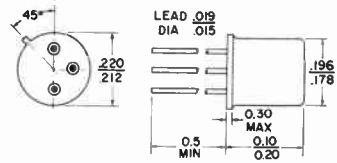

211B

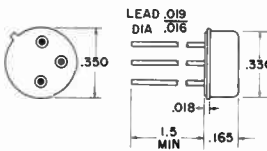

211C

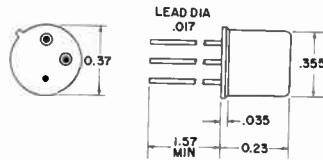

211E

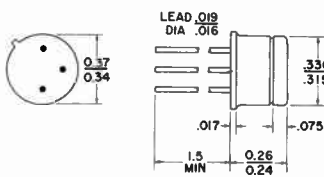

211F

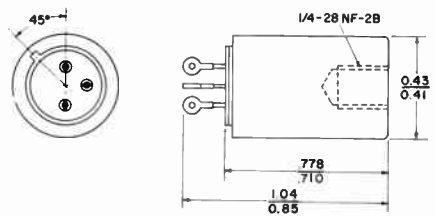

211G

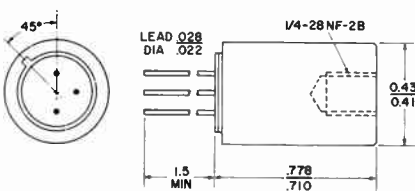

211H

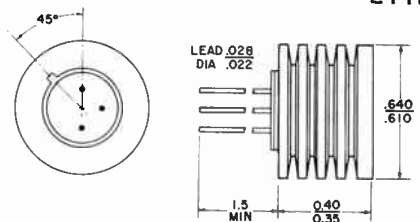

211K

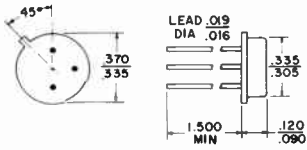

211L

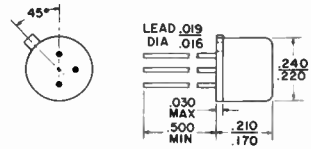

211M

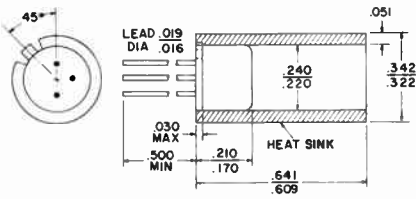

211P

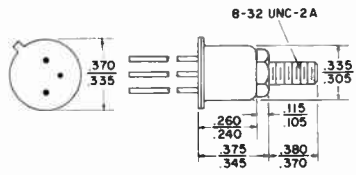

211Q

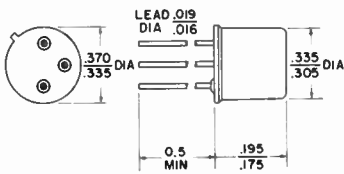

211S

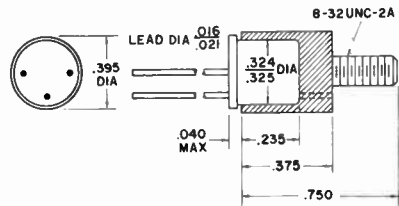

217B

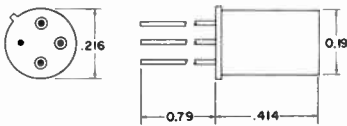

218E

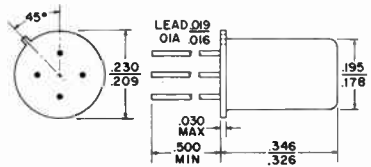

230A

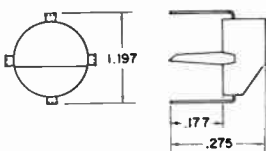

250A

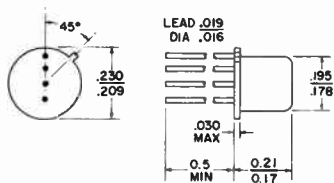

280A

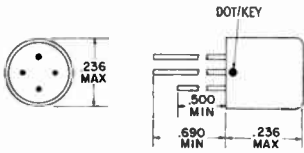

295A

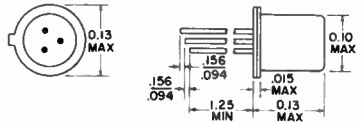

315A

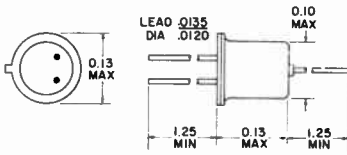

390A

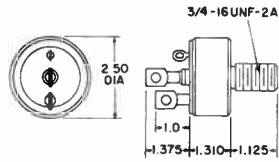

390B

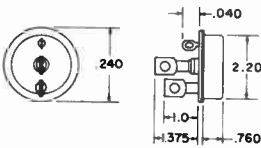

405A

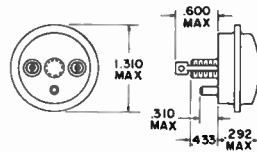

414A

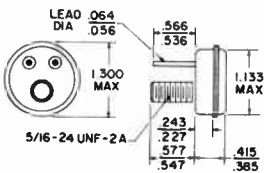

426A

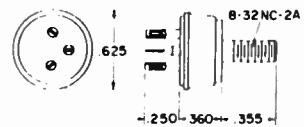

427A

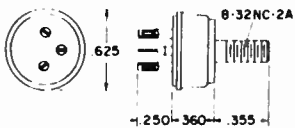

461A

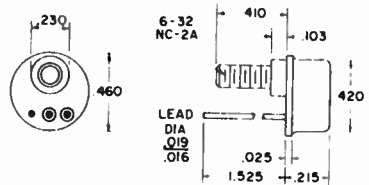

480A

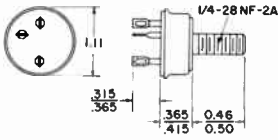

490A

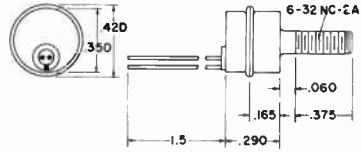

498A

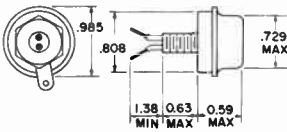

502A

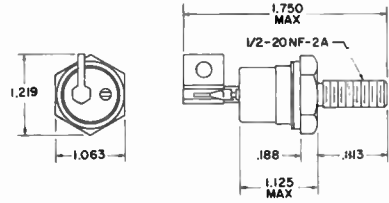

505A

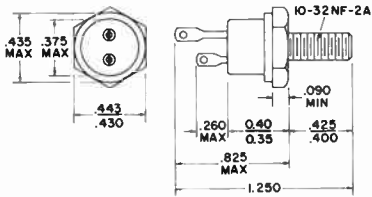

510A

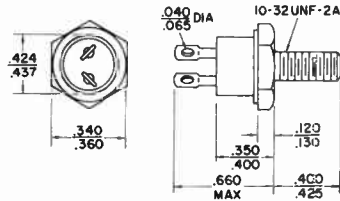

530A

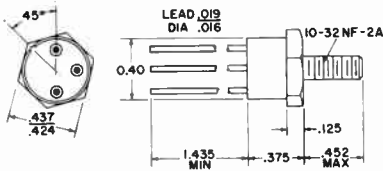

530B

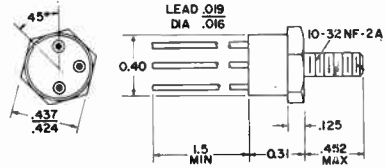

536B

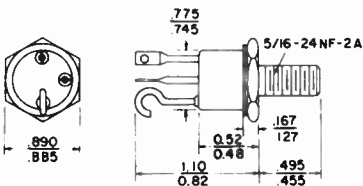

536H

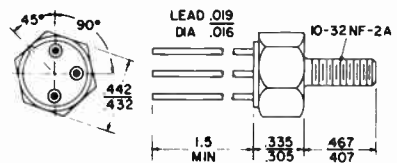

540A

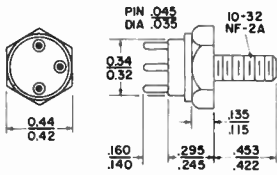

540B

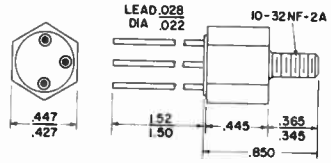

541A

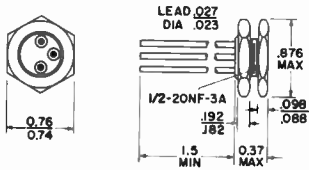

541B

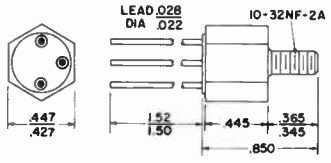

541D

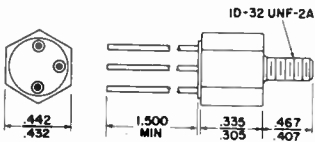

545A

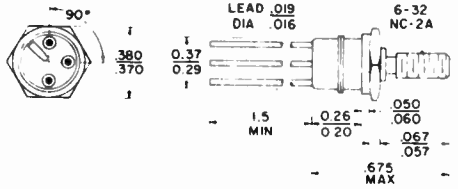

546A

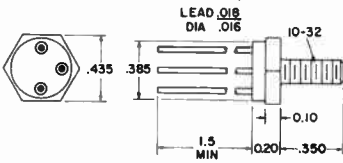

546C

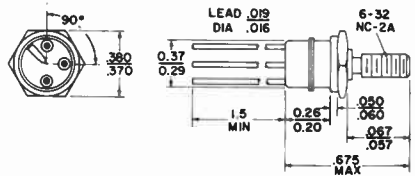

560A

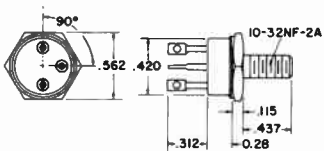

560H

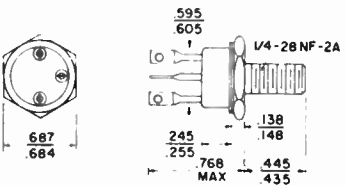

561B

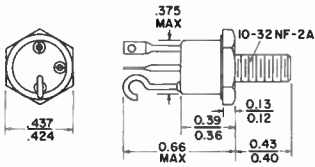

561F

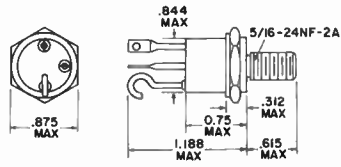

561G

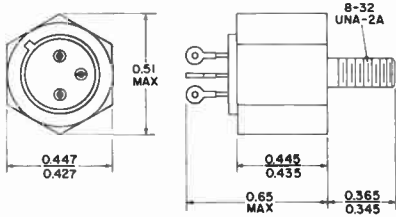

571A

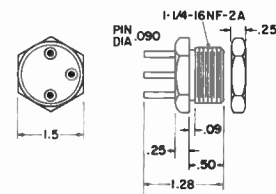

581B

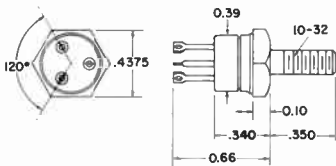

585A

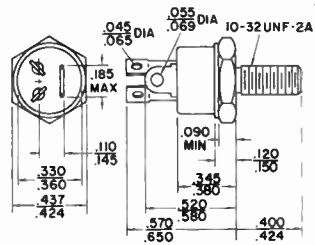

605A

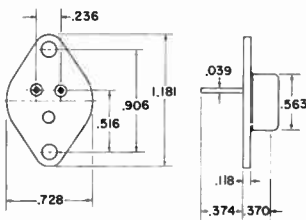

605B

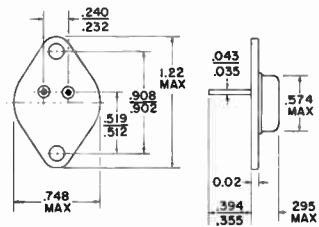

605C

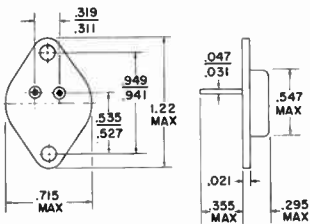

605F

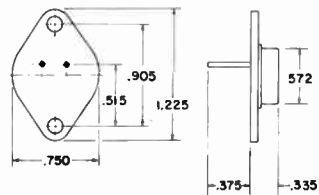

605G

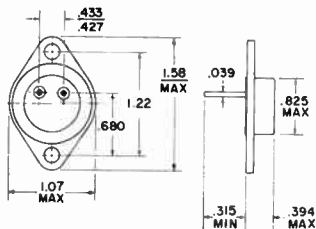

607A

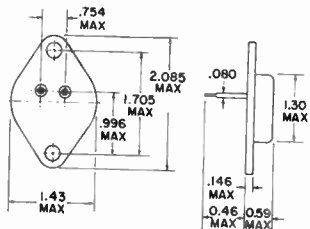

607B

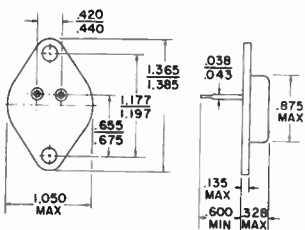

607C

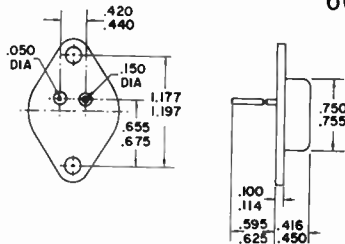

607D

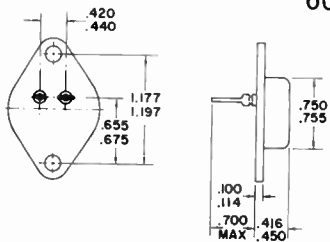

607E

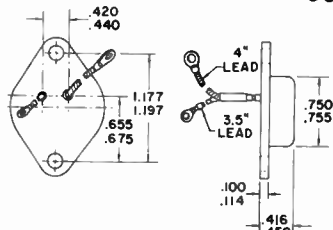

609A

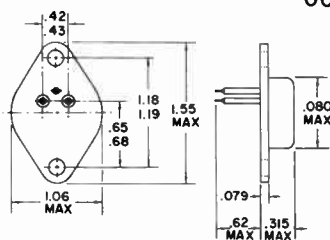

610A

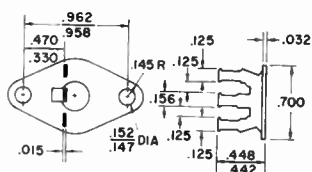

612A

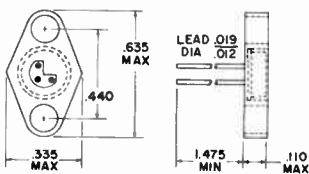

622A

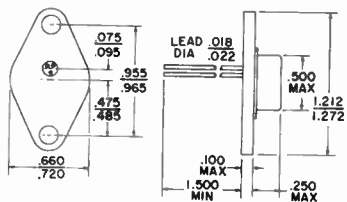

630A

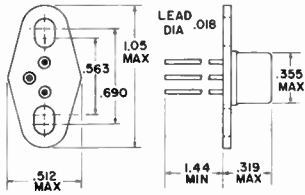

631B

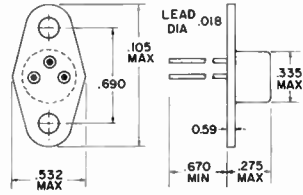

635B

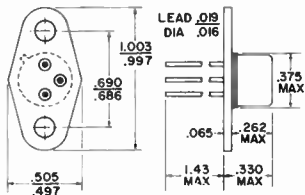

640A

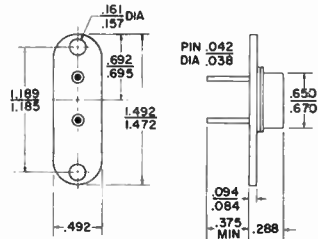

670A

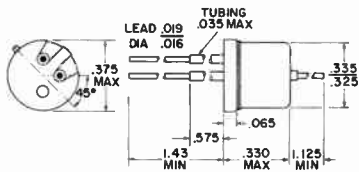

676A

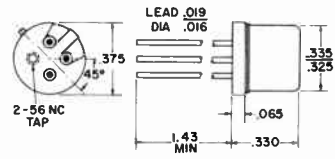

680A

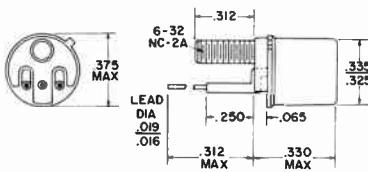

698A

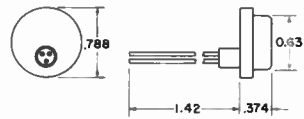

720A

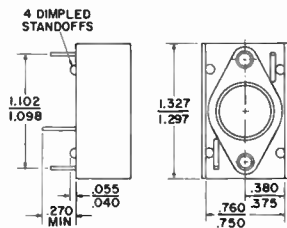

720B

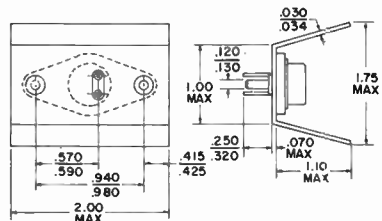

722A

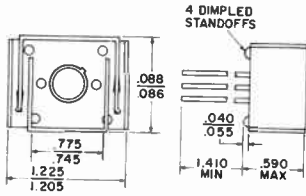

722B

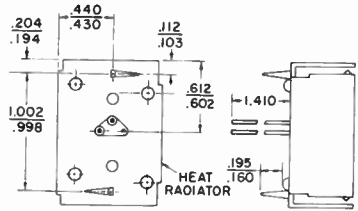

743A

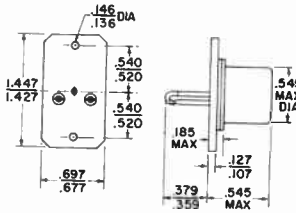

760A

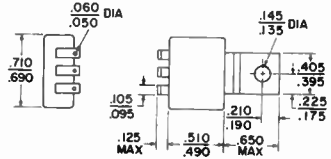

775A

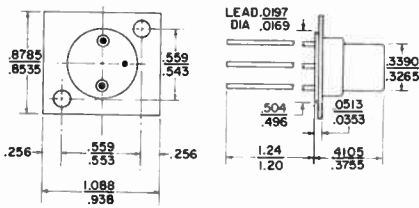

785A

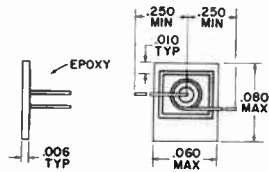

786A

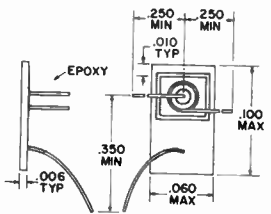

890A

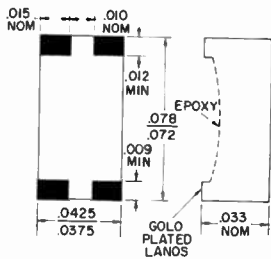

890B

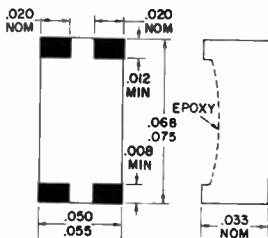

901A

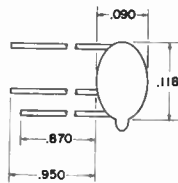

903A

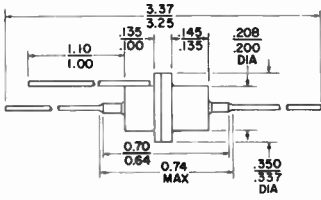

905A

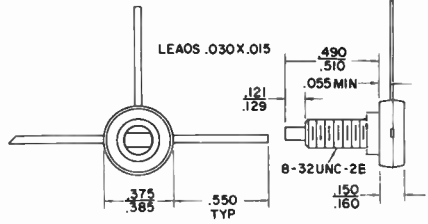

905B

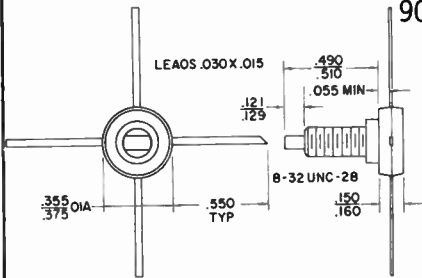

906A

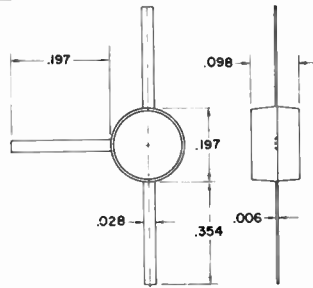

907A

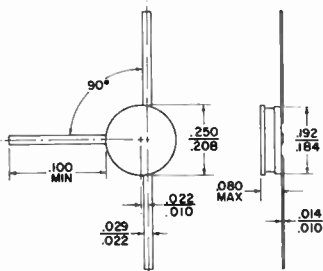

911A

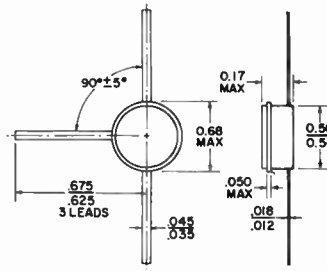

912A

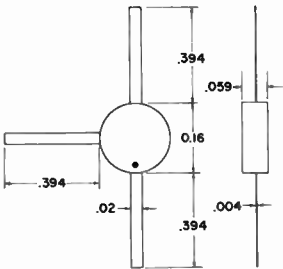

913A

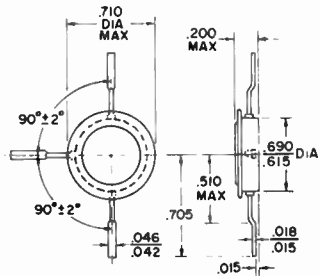

916A

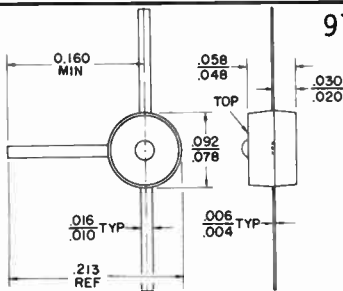

916B

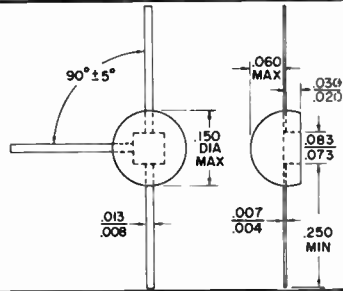

917A

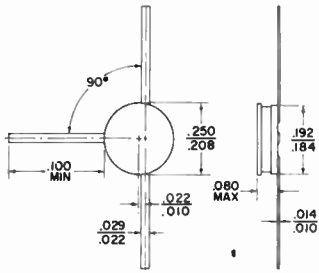

920A

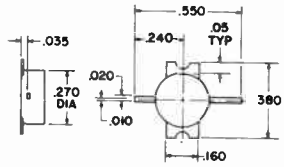

925A

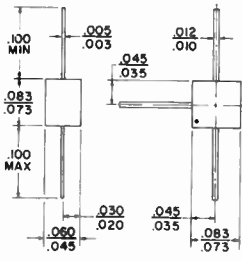

927A

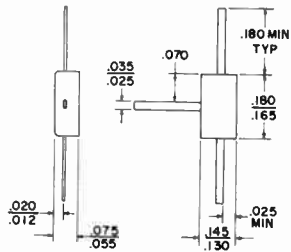

930A

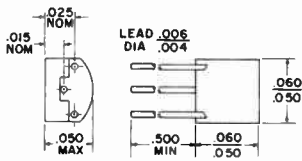

935A

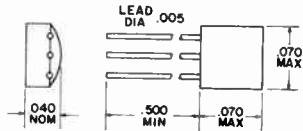

950A

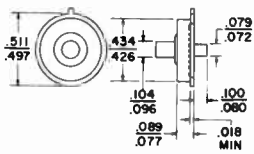

951A

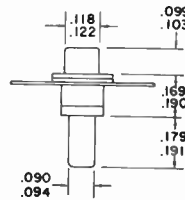

960A

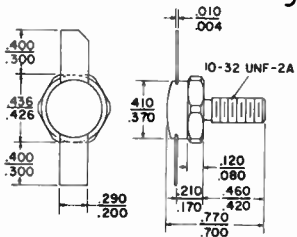

964A

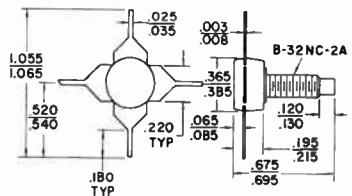

964B

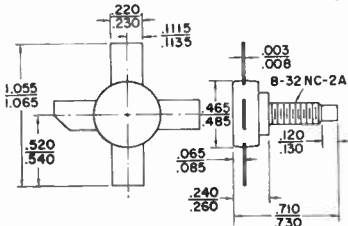

970A

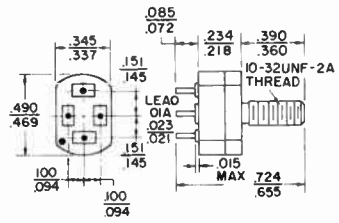

980A

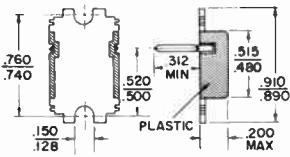

981A

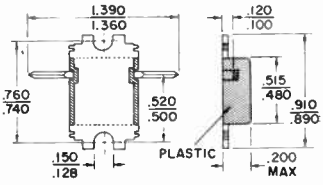

984A

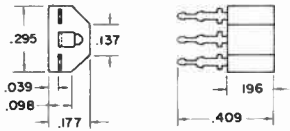

985A

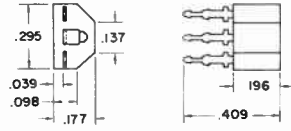



Lead and Terminal Identification

Identification of the leads or terminals of a semiconductor device is necessary before it can be connected into a circuit. A quick review of this section will show that it is nearly impossible to memorize which lead is the emitter, base, or collector.

Every transistor in this manual has a Lead Ident. number that corresponds to one of the diagrams in this section. These diagrams show the physical arrangement of the leads and terminals and identify each one as emitter "E", base "B", collector "C", or CASE. When the terminal is connected to both semiconductor and case, the designation shows both connections. For example, B(CASE) indicates that the base and the case are connected together. This is often ignored (but should not be) when a transistor is considered for inclusion in a circuit. Any one of the three terminals (E, B, or C) can be connected to the case; if the wrong terminal is so connected in some circuits, the frequency response can be affected. Also, this may place the case at the wrong potential, and an accidental short may destroy the transistor.

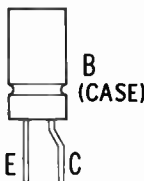
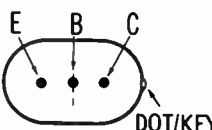
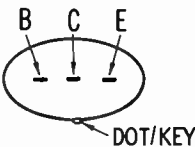
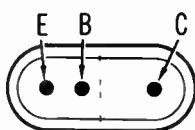
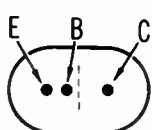
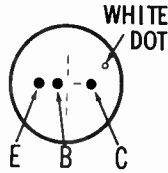
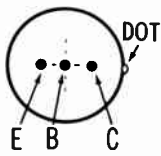
It is essential to check the terminals of the transistor carefully, and to be sure they are identified correctly, before the transistor is connected in the circuit.

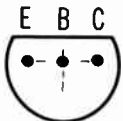
<p style="text-align: right; margin-right: 10px;">1</p> 	<p style="text-align: right; margin-right: 10px;">5</p> 	<p style="text-align: right; margin-right: 10px;">8</p> 
<p style="text-align: right; margin-right: 10px;">10</p> 	<p style="text-align: right; margin-right: 10px;">12</p> 	<p style="text-align: right; margin-right: 10px;">31</p> 
<p style="text-align: right; margin-right: 10px;">35</p> 	<p style="text-align: right; margin-right: 10px;">40</p> 	<p style="text-align: right; margin-right: 10px;">41</p> 

42



43

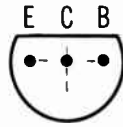

45

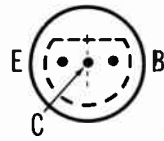

47

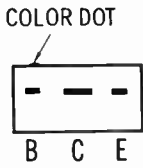

48



49

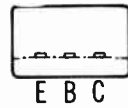

50

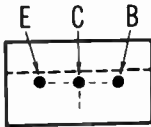

51

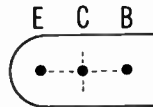

52

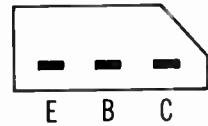

53

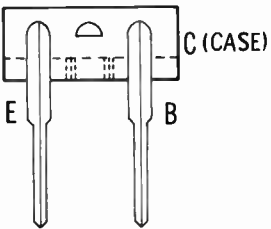

54

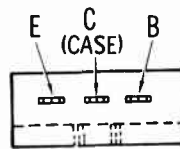

55

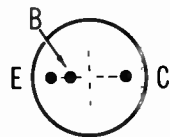

57

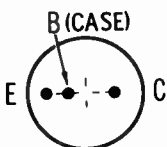

60

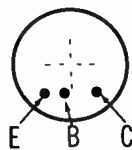

75

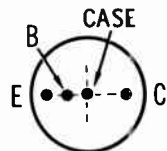

<p>80</p>	<p>100</p>	<p>105</p>
<p>106</p>	<p>110</p>	<p>116</p>
<p>117</p>	<p>120</p>	<p>124</p>
<p>128</p>	<p>132</p>	<p>133</p>
<p>146</p>	<p>148</p>	<p>168</p>

169

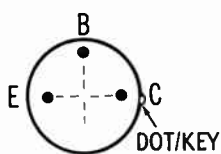

170

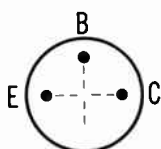

171

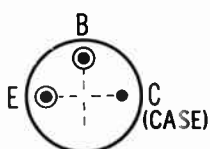

172

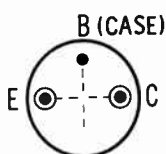

173

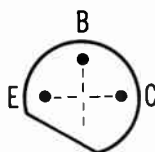

176

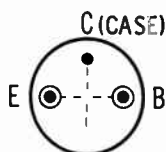

181

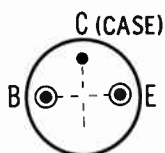

185

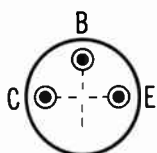

193

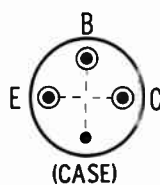

200

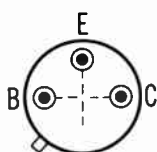

210

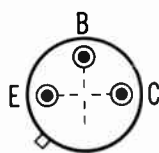

211

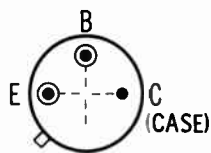

212

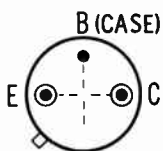

217

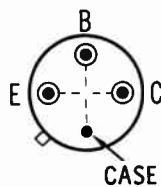

218

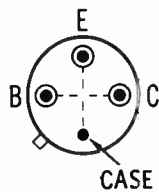

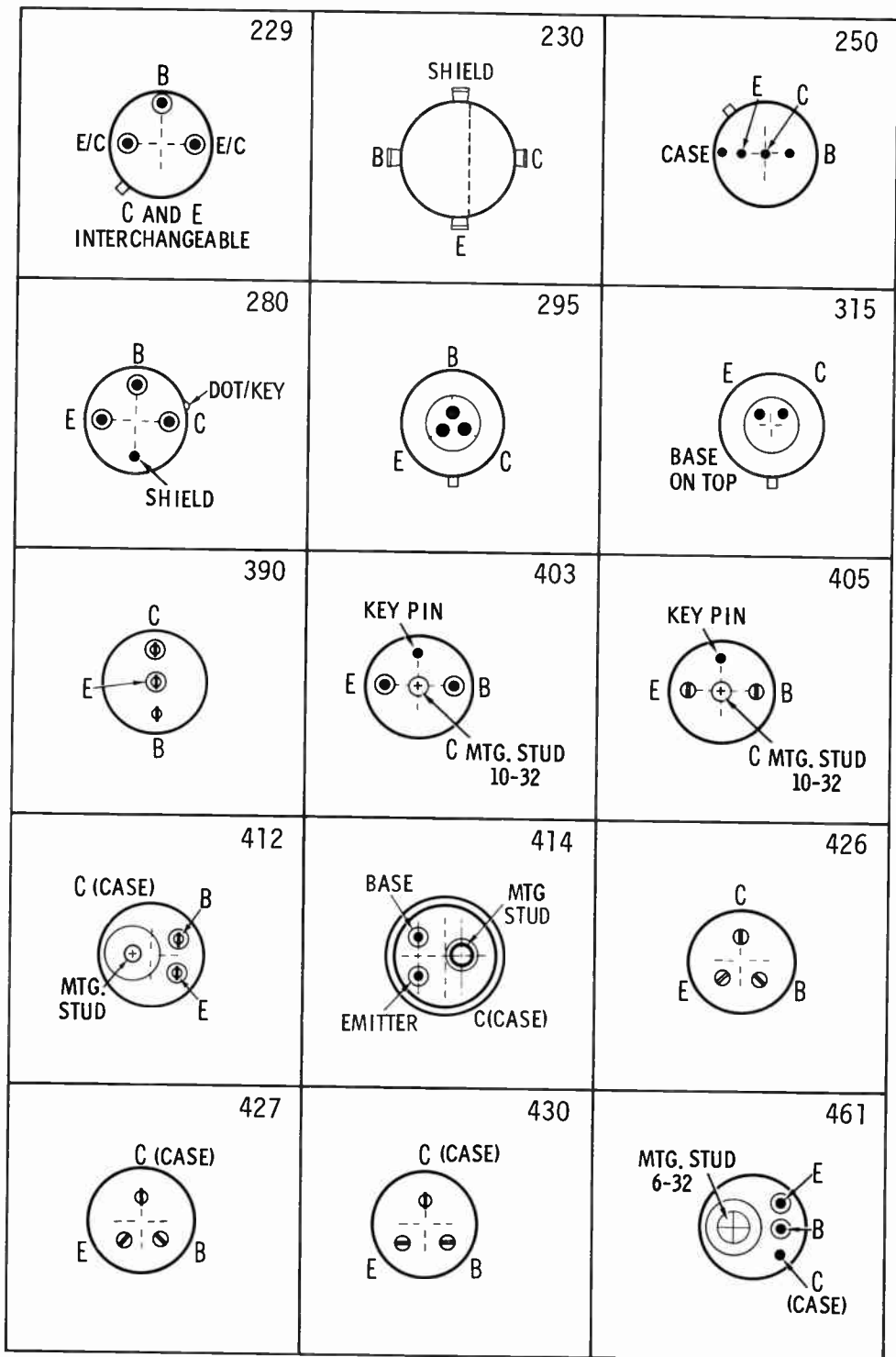

480

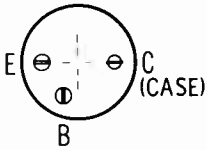

490

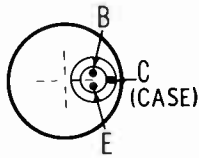

498

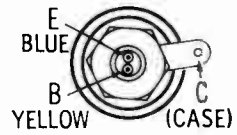

502

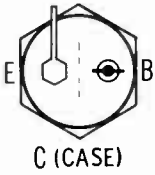

505

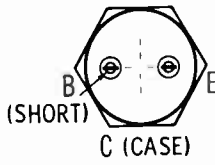

508

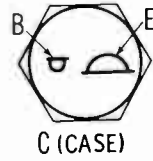

510

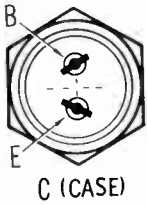

530

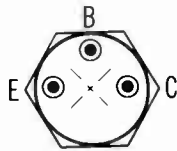

540

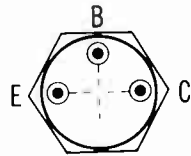

541

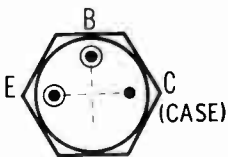

543

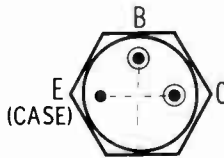

546

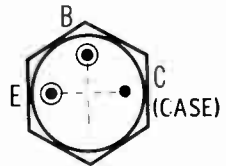

560

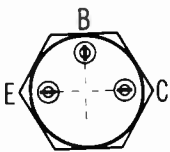

561

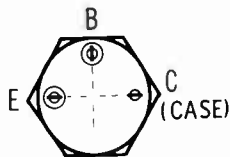

563

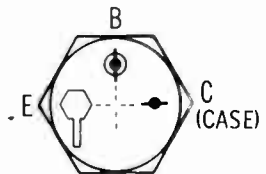

568

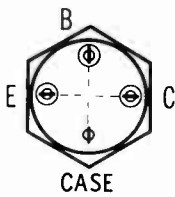

571

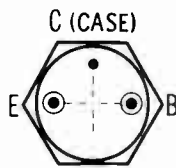

581

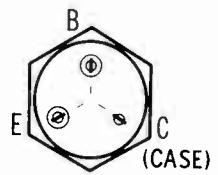

585

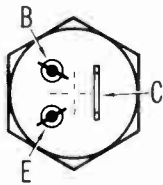

603

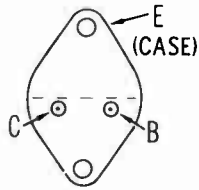

605

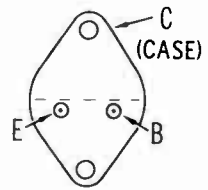

607

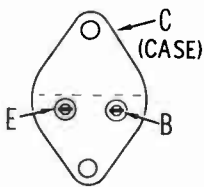

609

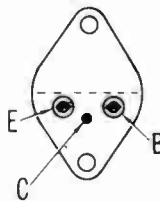

610

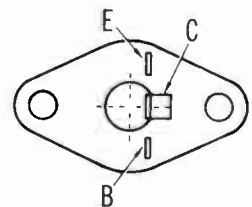

612

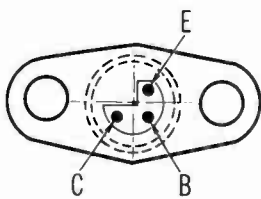

621

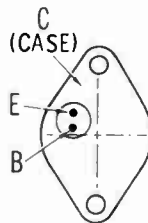

622

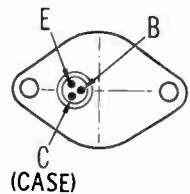

630

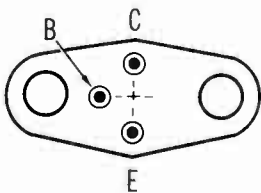

631

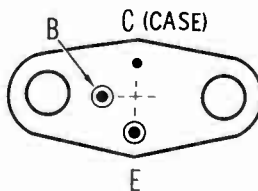

632

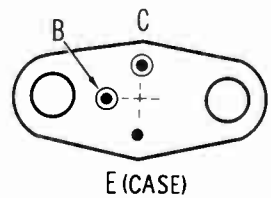

635

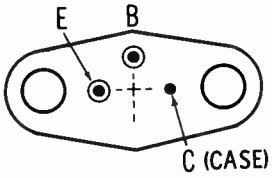

640

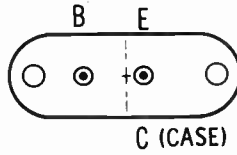

670



676

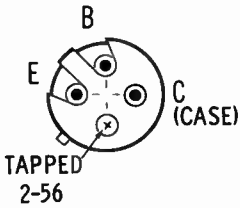

680

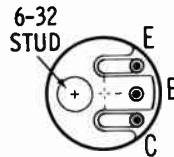

698



720

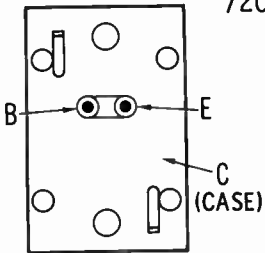

722

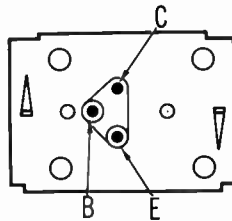

730

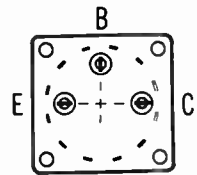

731

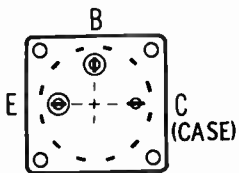

743

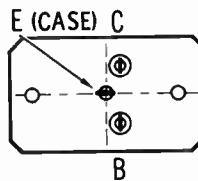

760

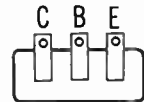

775

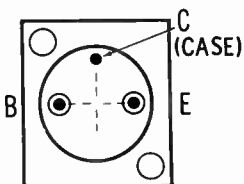

785

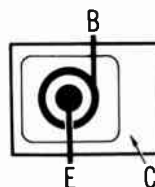

786

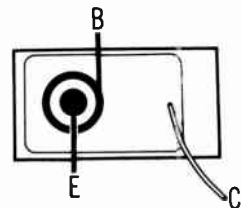

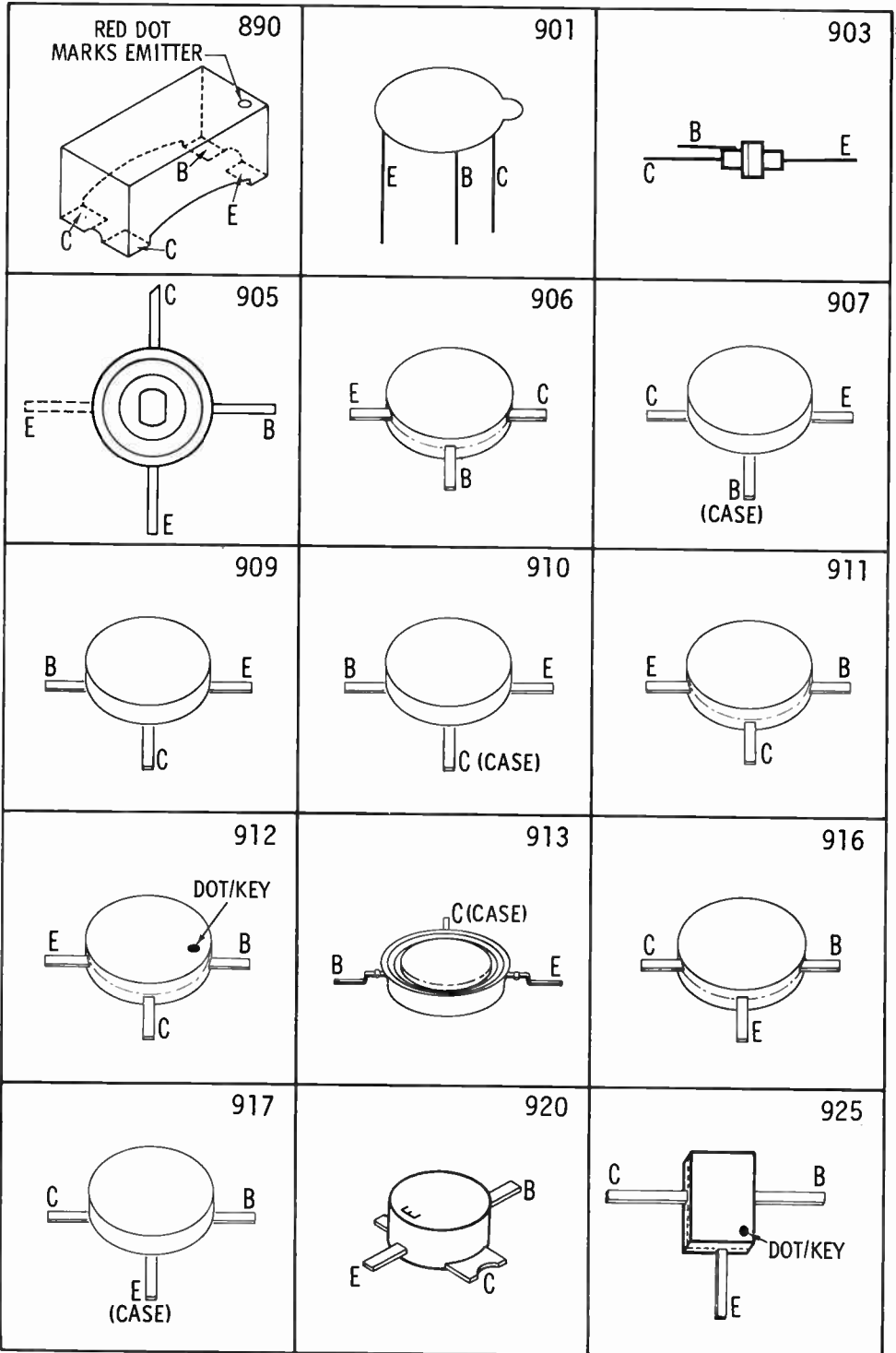

926

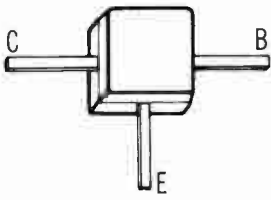

927

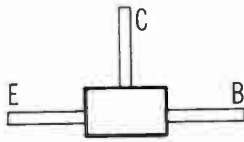

930

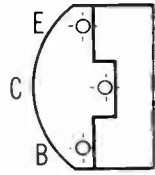

935

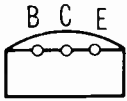

950

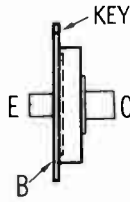

951

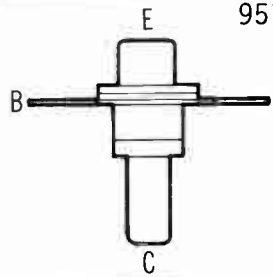

960

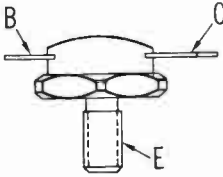

962

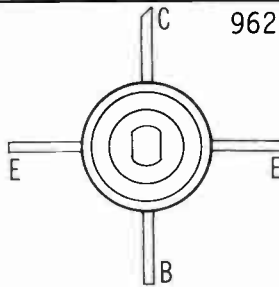

964

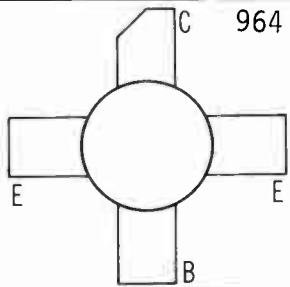

970

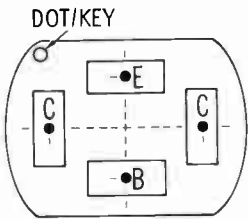

980

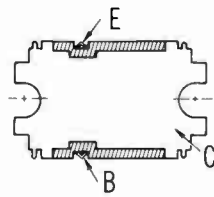

981

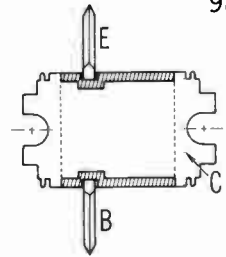

984

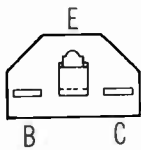

985

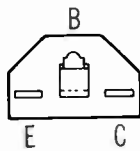

Key to Manufacturers

- AEI** — Associated Electrical Industries (England)
- AMC** — Amelco Semiconductor Division, Teledyne, Inc.
- AMF** — American Machine & Foundry Co., Leland Airborne Products Div.
- AMP** — Amperex Electronics Corp.
- ARV** — Arvin Industries
- BEN** — Bendix Corp., Semiconductor Div.
- CBS** — CBS Electronics
- CSF** — Compagnie Generale de T.S.F. (France)
- CLE** — Clevite Transistor Corp.
- DEL** — Delco Radio Div., General Motors Corp.
- EBA** — Ebauches S.A. (Switzerland)
- ETC** — Electronics Transistor Corp.
- FSC** — Fairchild Semiconductor Div., Fairchild Camera and Instrument Corp.
- GEC** — General Electric Co., Semiconductor Products Dept.
- GIC** — General Instrument Corp., Semiconductor Products Group
- GPC** — Germanium Products Co.
- GTC** — General Transistor Corp.
- HIT** — Hitachi Ltd. (Japan)
- HUG** — Hughes Aircraft Co., Microelectronics Div.
- IMG** — Intermetall (Germany)
- INR** — International Rectifier
- ITC** — Industro Transistor Corp.
- ITT** — ITT Semiconductors
- MAT** — Matsushita Electronics Corp. (Japan)
- MHR** — Honeywell, Military Products Group
- MOT** — Motorola Semiconductor Products, Inc.
- MUL** — Mullard Overseas Ltd. (England)
- NSC** — National Semiconductor Corp.
- NEC** — Nippon Electric Co. Ltd. (Japan)
- NKT** — Newmarket Transistors Ltd. (England)
- OKI** — OKI Electric Industry Co., Ltd. (Japan)
- OLS** — Olson Electronics, Inc.
- PHF** — Philco-Ford Corp.
- PHN** — Phillips Gloelamperfabrieken (Netherlands)
- RAD** — La Radiotechnique (France)
- RAY** — Raytheon Co., Semiconductor Div.
- RCA** — Radio Corporation of America, Electronic Components & Devices
- SAN** — Tokyo Sanyo Electric Co., Ltd. (Japan)
- SEJ** — Shindengen Electric Manufacturing Co., Ltd. (Japan)
- SEM** — Semitronics Corp.
- SES** — Societe Europienne des Semiconducteurs (France)
- SIH** — Siemens and Halske Aktiengesellschaft (Germany)
- SOL** — Solitron Devices, Inc.
- SON** — Sony Corp. (Japan)
- SPC** — Solid Power Corp.
- SPR** — Sprague Products Co.
- SSD** — Sperry Semiconductor
- SSP** — Solid State Products, Inc.
- STB** — Standard Telephone & Cables (England)
- STC** — Silicon Transistor Corp.
- SYL** — Sylvania Electric Products Inc., Semiconductor Div.
- TAD** — Tadiran (Israel)
- TEC** — Transitron Electronic Corp.
- TFK** — Telefunken Gmbh. (Germany)
- TII** — Texas Instruments, Inc.
- TOS** — Toshiba America, Inc.
- TRW** — TRW Semiconductors, Inc.
- TSE** — Tung-Sol Electric, Inc.
- WHE** — Westinghouse Electric Corp., Semiconductor Div.
- WTV** — Workman Electronic Products, Inc.
- ZEN** — Zenith Radio Corp.

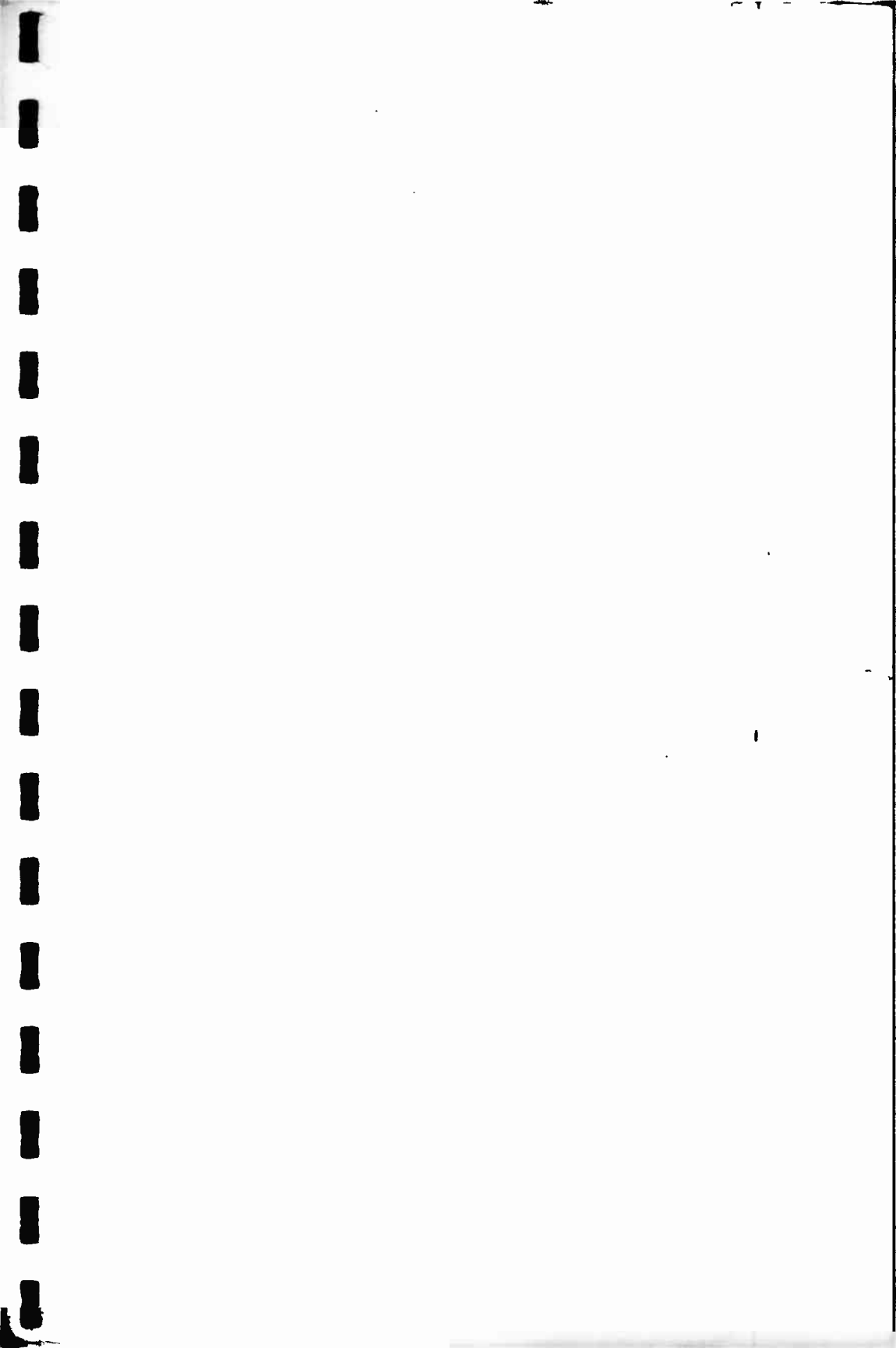

TRANSISTOR SPECIFICATIONS MANUAL

FOURTH EDITION

Anyone who works with transistors is familiar with the difficulties involved in locating electrical and physical data for a specific type. Unless the manufacturer is known and his published information is available, a long, and possibly fruitless, search can result. This manual has been compiled in order to alleviate these problems. It lists the electrical and physical parameters, along with the manufacturers of nearly ten thousand transistor types.

For each bipolar transistor in this manual there is given the polarity (nnp or pnp), maximum applied voltages (C_{CB} , V_{CE} , V_{EB}), power dissipation, collector current (I_c), operating frequency (f_{ab} , f_{ae} , f_{esc} , or f_i), collector cutoff current (I_{CBO}), and d-c current gain (h_{FE}). A new, separate listing of rf-power transistors includes design frequency, power output, power gain, and collector efficiency in addition to most of the other information. All EIA-registered TO outlines are shown. Where a nonstandard case is used, a dimensioned drawing is provided in a separate section. Transistors are keyed to diagrams that indicate the physical position of the emitter, collector, and base terminals. If there is an internal connection to the case, this is noted.

The manufacturers of each transistor type are shown. Where available information indicates that the type is no longer being made, the last known manufacturer is provided, and that transistor type is marked obsolete.

A large quantity of information has been condensed into this *Transistor Specifications Manual* so you can find quickly what you need to know about nearly any transistor.



HOWARD W. SAMS & CO., INC.
THE BOBBS-MERRILL CO., INC.

20788
\$4.50 (In Canada \$5.40)

12/95
HALF PRICE BOOKS
\$ 2.25