

review

04|2019 en

E-mobility

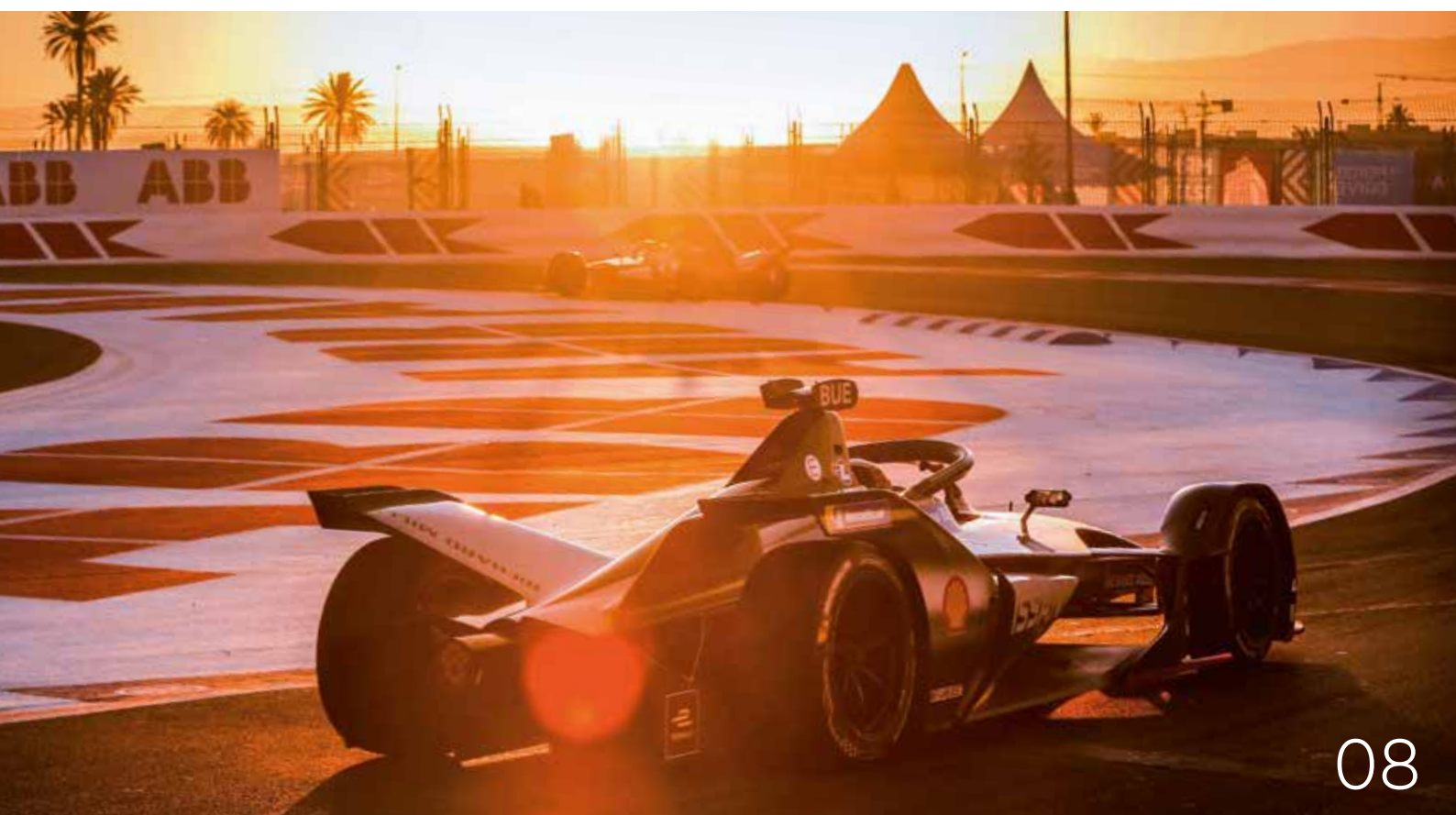

08



24

- 06–43 E-mobility
- 44–79 Productivity



Photo: TenneT

Circuit-breaker drives



Collaborating on EV infrastructure

Racing into the future





Machines learning machines

05 Editorial

E-mobility

- 08 Racing into the future
- 14 Electrifying Niagara Falls ferries
- 18 Welcome aboard hydrogen
- 24 Why electric bus range does not matter
- 30 The future of the power grid
- 38 Collaborating on EV infrastructure

Productivity

- 46 Machines learning machines
- 52 Optimizing the entire powertrain
- 56 Virtual prototyping of sensor systems
- 64 Asset optimization
- 68 Circuit-breaker drives
- 74 Performance monitoring in SCADA

Buzzword Demystifier

80 Hybrid

81 Subscribe

81 Imprint

82 Index 2019



ABB is using more than a century of mission-critical experience to find new and better ways to put electricity to work. Since electricity moves at speeds approaching that of light itself, and its underlying physics drive the challenges and opportunities for how it's used, this issue of ABB Review captures snapshots of innovations that are moving very, very fast.



EDITORIAL

E-mobility



Dear Reader,

With transportation accounting for about one fifth of worldwide anthropogenic carbon emissions, it presents a clear case for decarbonization and electrification. Globally, the market share of new all-electric automobiles has grown to five percent (from virtually nothing some years ago). In some countries the figure is far higher: In Norway, for example, more than 50 percent of new cars are now electric. And this is only the beginning.

The changeover from fossil fuel to electric is not just a question of replacing one power source by another, but is creating an entire new infrastructure, from the management of energy sources down to the physical charger.

There is much more to electric transportation than cars. Since its early days, ABB has been closely connected to railway electrification. Electrification is also re-shaping the bus market, and even ships are going emission-free. These and many more aspects are explored in the present issue of ABB Review.

Enjoy your reading.

A handwritten signature in red ink, appearing to read 'Bazmi Husain', with a stylized flourish at the end.

Bazmi Husain
Chief Technology Officer



E-mobility



The transformational change of electric mobility is a race to put new technologies to work for the benefit of businesses, society, and the environment. ABB helps get electricity to more users when and where it's needed and, in the case of motorsports, drive race cars across the finish line.

- 08 Racing into the future with the ABB FIA Formula E Championship
- 14 Electrifying the Niagara Falls Maid of the Mist ferries
- 18 Welcome aboard hydrogen – QRV?
- 24 The electric bus – range is a matter of perspective
- 30 The future of the power grid in the coming era of e-mobility
- 38 EV infrastructure innovation through collaboration



E-MOBILITY

Racing into the future with the ABB FIA Formula E Championship



01



The ABB FIA Formula E Championship – a class of motorsport for electric-powered cars – presents not just a thrilling racing spectacle but also a versatile platform upon which to test and demonstrate e-mobility electrification and digitalization technologies.



Anthony Rowlinson
Asea Brown Boveri Ltd
Zurich, Switzerland

anthony.rowlinson@ch.abb.com



02

	Gen2 (Season 5)	Gen1 (Season 1–4)
Top speed (km/h)	280	225
Acceleration, 0–100 km/h (s)	2.8	3.0
Power in race mode (kW/hp)	200/270	180/240
Maximum power, Attack Mode (kW)	250 (335)	n/a
Battery capacity (kWh)	54 (full race length)	28 (car swap, mid-race)
Battery voltage (V)	900	700
Battery weight (kg)	385	320
Minimum weight (kg)	900	880
Race length	45 min + 1 lap	Track dependent

03

The global e-mobility revolution has many forms: experimental electric aircraft, autonomous ferries, fast-charging bus fleets, or the increasingly familiar sight of Web-connected electric vehicles (EVs) on public roads.

However, there is one e-mobility arena that takes the prize for high-profile, pioneering innovation: the ABB FIA Formula E Championship. This annual event pits 22 of the world's most talented drivers against each other in the most advanced electric race cars yet created. The championship has been

running since its inauguration in Beijing in 2014 and has been title-partnered by ABB since January 2018 →1.

The sound of silence

Perhaps the most notable aspect of ABB Formula E is the noise – or, more accurately, the lack thereof. As the world's first global, all-electric motor-racing category, the race series was born of an idea that would shatter one of the most dearly held conventions in motorsport: that racing should be ear-splittingly noisy, thanks to highly tuned internal combustion engines spinning at up to 20,000 rpm.

The ABB FIA Formula E Championship pits 22 of the world's most talented drivers against each other in the most advanced electric race cars yet created.

Since its inception, ABB Formula E has taken a radically different approach by adopting battery-powered cars driven by high-efficiency electric powertrains that use some of the world's most advanced e-mobility technology. As they compete on ever

01 Nissan team "Nissan e-Dams" action during the 2019 Formula E Championship at Marrakesh, Morocco.

02 The roar of Formula One is replaced by the quiet whine of some of the most advanced e-mobility technology on the planet. Here, the 2019 Formula E Championship in January in Santiago de Chile, Chile.

03 Gen2 cars compared with Gen1.

04 Exploded diagram of a Formula E car.

05 The 2019 Formula E Championship in Hong Kong. Jean-Éric Vergne of France driving the Gen2 DS E-Tense for the DS TECHEETAH team.

more city-center racetracks around the globe, the cars' characteristic, muted high-pitched whine is becoming a familiar replacement for the roar of petrol-driven vehicles of other racing series →2.

Going from strength to strength

In under five years, ABB Formula E has blossomed from an audacious start-up, that was dismissed as a niche curio by both hardcore motorsport fans and the less visionary quarters of the automotive sector, into a sporting property of such relevance that major car manufacturers are now pushing their way into the championship, keen to flaunt their e-mobility credentials through competition success. Already the likes of Audi, BMW, Nissan and Jaguar field leading teams; next season they will be joined by blue-chip industry titans Porsche and Mercedes-Benz.

ABB Formula E showcases advanced electrification technology, connected mobility and urban transport solutions.

The championship is flourishing because of the relevance of its proposition at a time of growing concern over matters of sustainability, energy efficiency, pollution and urban congestion. In a single package that maintains a visceral sporting appeal at its core, ABB Formula E can showcase

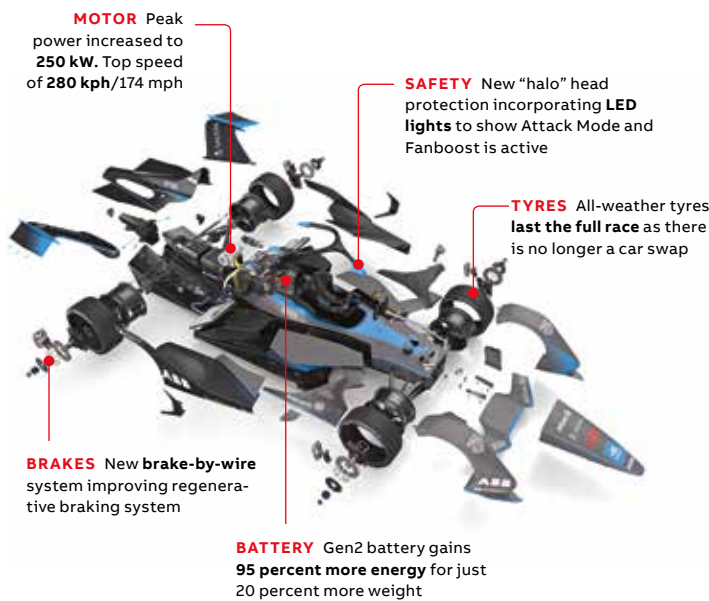

04



05

simultaneously: advanced electrification technology; urban transport solutions; the latest ideas in connected mobility; smart city visions and developments in sustainable power generation.

Putting the “E” into ABB Formula E

At the heart of the championship is a field of fast, electric racing cars driven by 22 of the world’s most talented drivers – many of whom have been drawn from Formula 1 racing.

Each of the 11 two-car, two-driver, teams competes with their own variant of the same basic machine: an open-cockpit single-seater built around an impact-resistant and highly protective carbon-fiber monocoque, which cocoons the driver.

The suspension is hung from this central component and aerodynamic bodywork cloaks

the inner workings. This much is relatively conventional and typical of almost any contemporary single-seat racer.

It is behind the driver that the defining hardware of an ABB Formula E race car is hidden.

But it is behind the driver that the defining hardware of an ABB Formula E race car is hidden. Instead of a fuel tank, internal combustion engine and a multi-speed, semi-automatic gearbox, the “Gen2” racer, introduced in 2019, has a large, high-efficiency battery, one or two motors and a single-speed transmission →3–5. These are the elements that put the “E” into ABB Formula E.



06



07



08

—
06 The Gen2's improved battery performance means the mid-race car changeover can be dispensed with.

—
07 Recently introduced electronic control of regenerative braking systems has further improved car performance.

—
08 The racing version of the Jaguar I-PACE benefits from ABB trackside charging technology.

Better batteries

The cars' batteries are built and supplied by McLaren Applied Technologies (MAT) – a sister company of the famous McLaren racing team. The batteries are common to every car and central to the car's performance.

Weighing around 385 kg, the battery is both larger and heavier than the unit supplied for the earlier generation of cars that raced from seasons one to four and its peak output of 900V is an increase of 200V over the previous technology. It permits peak power of 250 kW – approximately 330 bhp – and can propel the cars to top speeds of around 280 km/h.

More significant than these headline figures, however, is that the battery's increased capacity and efficiency allows ABB Formula E cars to complete a full race distance on a single charge. Over the first four seasons of racing, technological limitations meant that drivers would drive half the race in one car then swap to an identical machine with a full battery.

While this unique changeover procedure provided a distinctive ABB Formula E spectacle, it also drew attention to a specific consumer hesitancy that has hindered widespread EV adoption: range anxiety. The Gen2 car's bigger battery pack counters that concern, however, thanks to a 95 percent energy increase for a 20 percent weight gain →6. In this aspect more than any other, ABB Formula E has demonstrated the rapid pace of technical advancement across the e-mobility landscape.

MAT's Gen2 battery pack was developed with particular regard for temperature management. Its internal lithium cells are highly sensitive to temperature: too cool and efficiency is not optimized; too hot and output life suffers. Homogenous cooling across the multiple individual cells inside the pack was, therefore, a key design goal.

Technology test platform

Elsewhere beneath the aggressively styled bodywork of the Gen2 cars lie experimental technical developments. ABB Formula E provides an ideal rigorous environment in which companies can put their new technology through its paces. For example, twin-motor installations, where each motor is dedicated to one rear wheel (rather than the drive from a single motor being split between two) have been evaluated for potential traction and drivetrain efficiency benefits.

All cars incorporate regenerative braking systems that harvest significant amounts of energy during the many intensive decelerations on the circuit. Until this season, each car's so-called

“regen balance” was controlled by the driver but electronic control introduced for season five has enhanced the process →7. This is precisely the kind of sophisticated energy management technology that is invaluable to car manufacturers in developing class-leading road models.

Taking charge

ABB has brought its technical expertise to the Jaguar I-PACE eTROPHY series that supports ABB Formula E at 10 races this season.

The Jaguar I-PACE all-electric SUV was named the 2019 Car of the Year at the New York International Auto Show by a panel of 86 motoring journalists from 24 countries, just weeks after it claimed the European Car of the Year title. The race-prepared version of the I-PACE is powered at the trackside by custom-made variants of ABB's Terra 53 DC charger →8. To meet the demands for a charger that could be both mobile at racetracks and easily transported between them, ABB commissioned a team of its engineers to reconfigure a standard Terra unit into a smaller package, with wheels, for easy freighting and maneuverability. By mid-season, the charger units had operated with a 100 percent success rate.

—
The Gen2 car's bigger battery pack has a 95 percent energy increase for a 20 percent weight gain.

These are exciting times for ABB Formula E, with the championship in rude health and further ABB technical collaborations under discussion. As a platform upon which to test pioneering e-mobility technology and show the world the capabilities of electric vehicles, the championship is unparalleled. As Sébastien Buemi, a driver for Nissan e.Dams (a Formula E team), Season 2 champion and ABB ambassador, sums up: “When we compete in ABB Formula E, it feels like we are driving the future.” •

E-MOBILITY

Electrifying the Niagara Falls Maid of the Mist ferries

ABB zero-emission technology will power the next-generation, fully electric ferries on the iconic Maid of the Mist tour at the Niagara Falls. The two new vessels will be powered solely by high-capacity battery packs, making them the first purely electrically powered vessels built in the United States.



Priscila Faester
ABB Inc. Marine and Ports
Miramar, FL, United States

priscila.faester@
us.abb.com

It is appropriate that one of the latest advances in electrical power should be associated with the Niagara Falls. Here it was, in 1896, during the War of the Currents that pitted Edison's DC against Tesla's AC [1], that the switch was thrown on George Westinghouse's Niagara Falls Power Project. This historical event saw AC electricity flow to consumers in nearby Buffalo – the first city in the United States to have widespread street lighting and a place still known as “The City of Light.” Just a few years later, the AC power generated by the Niagara Falls was illuminating many parts of New York City, including Broadway. The project was one of the first large-scale hydropower plants in North America and a personal triumph for Tesla.

Westinghouse and Tesla in AC power. In a further twist to the story, a century later, in 1989, ABB acquired Westinghouse's transmission and distribution business.

Now, over 120 years after this early pioneering work in electrical engineering, the Niagara Falls are once more the focal point of technical innovation: ABB zero-emission technology will power the next-generation, fully electric ferries that will replace the current diesel vessels that take over 500 visitors at a time on the iconic Maid of the Mist tour. This tour sails past the base of the American Falls and into the basin of Horseshoe Falls – the largest of the three waterfalls at Niagara →1. This excursion is not only one of the top attractions in the United States, but also the oldest.



Edward Schwarz
ABB Inc. Marine and Ports
Miramar, FL, United States

edward.schwarz@
us.abb.com

Over 120 years after this early pioneering work in electrical engineering, the Niagara Falls are once more the focal point of technical innovation.

The two new 28 m catamaran vessels will be powered solely by high-capacity battery packs, making them the first fully electric vessels ever built in the United States (usually, electric boats and ships have auxiliary diesel generators to power onboard ancillary systems or to provide thrust when the electric propulsion is unavailable).

Emission remission

The Niagara Falls are a wonder of the natural world – and as such should be enjoyed without having to breathe in fumes from marine engines or endure the noise and vibrations the current ferries generate →2. Now, the nearly silent electric

ABB was involved in the Tesla/Westinghouse saga too: In 1891, the Swiss-born Charles Brown, then Europe's top AC engineer, cofounded Brown, Boveri and Company (ABB's predecessor), which helped General Electric fight the dominance of



01

01 Artist's rendering of the two new all-electric Maid of the Mist tour boats. The boats' design is modular. The modules were built in a shipyard then trucked to site, where they were craned into the assembly area near the river. Craning the vessel modules to the assembly area was challenging due to the difficult topography of the area. The boats' hulls are made from 5086 H116 marine-grade corrosion-resistant aluminum alloy.

ferries – due to enter service in late 2019 – will carry passengers up to the falls and allow them to take in their majesty while breathing clean air, just as nature intended.

The 7-minute battery boost enables the vessel's dual electric propulsion motors to maintain their total output of 400 kW.

In the dock and charged

The Maid of the Mist boats set off from their downstream dock for the base of Niagara Falls every 30 minutes, serving 1.6 million guests annually. While the ferry is docked and passengers are embarking and disembarking, the new boats' lithium-ion batteries will be recharged. The

seven-minute charge provides a battery boost to enable the vessel's dual electric propulsion motors to maintain their total output of 400 kW (563 HP). Each trip consumes about 38 kWh. The batteries are charged up to 100 percent overnight and still have 80 percent at the end of the working day. Naturally, the electricity needed to charge up the 316 kWh battery packs comes from zero-emission hydropower.

All-electric for all

The ferry company – the Maid of the Mist Corporation, founded in 1846 – is family owned and operated and their step forward in demonstrating the commercial viability of all-electric boat technology has attracted attention from around the world. The Niagara boats might be among the first all-electric vessels, but they will not be the last: Passenger ferries, river barges, harbor tugs and dredgers are just some classes of vessel that are

eminently suited to all-electric operation. Marine vessels are one of the largest contributors to transportation emissions (3 to 5 percent of global CO₂ and over 5 percent of global SO_x) so electrification of shipping cannot come soon enough.

Currently, it would be difficult to build ocean-going vessels that are 100 percent electric. However, as equipment becomes smaller and more cost-effective, doors are opened for many new opportunities not thought possible just a few years ago. Autonomous, all-electric high-sea vessels might just set sail some day in the not-too-distant future.

ABB is moving with e-mobility

ABB is supporting e-mobility for applications outside the maritime world too – for example, with public and private EV charging solutions (over 10,000 ABB DC fast chargers had been sold in 73 countries by the start of 2019). Looking ahead, products such as ABB's Terra HP high-power charger are designed to accommodate the higher-capacity batteries of tomorrow as well as those of today.

ABB is helping stakeholders across the globe establish electric bus services that reduce human impact on the environment. ABB is also a founder

of both the CHAdeMO and CCS alliance charging standards. Further, ABB launched its first DC fast charger in 2010, the first nationwide DC charging networks in 2012 and the first eBus charging networks in Europe in 2016.

—
Looking ahead, products such as ABB's Terra HP high-power charger are designed to accommodate the higher-capacity batteries of tomorrow.

New horizons in marine battery technology

Global interest in marine electrification is being spurred on by, for instance, new International Maritime Organization (IMO) rules, such as the 2020 IMO fuel sulfur regulation, which will reduce the limit on the sulfur content of bunker fuel. Maritime operators are therefore keen to explore fuel cell technology and for this reason ABB has research projects in this area. For instance, ABB is a member of the MARANDA project [2], a joint venture of several companies financed by the European Union. The project will design and



—
02 One of the current Maid of the Mist ferries at American Falls, Niagara. The new all-electric ferries will be noise-, emission- and vibration-free.

—
03 Iceland's first electric ferry, visualized by Polarkonsult, a design partner of the vessel.



03

implement a 165 kW proton-exchange membrane fuel-cell unit for the research vessel Aranda. The main objective is to verify the fuel cell's ability to produce emission-free electrical power with low noise and vibration levels. ABB will deliver the electrical power conversion technology needed to attach the fuel cell system to the vessel's electrical power plant.

The MARANDA project will design and implement a 165 kW proton-exchange membrane fuel-cell unit for the research vessel Aranda.

In a separate development, ABB and Ballard Power Systems, the leading global provider of innovative clean energy fuel cell solutions, have signed a Memorandum of Understanding (MoU) to jointly develop a next-generation, fuel-cell power system for sustainable marine e-mobility [3,4].

The fuel-cell power system will play a significant role in accelerating the adoption of sustainable solutions for marine e-mobility and help shipowners meet increasing demands for clean operations.

The two partners will leverage existing kW-scale fuel-cell technologies and optimize them to create a pioneering MW-scale solution suitable for powering larger ships. With an electrical generating capacity of 3 MW (4,000 HP), the new system will fit within a single module no bigger than a traditional fossil-fuel marine engine.

E-mobility for a greener world

Battery technology also underpins zero-emission, electrified vessels ABB has already equipped in Europe – for example, Iceland's first electrified ferry →3. This boat will carry 75 cars and 550 passengers on a sometimes treacherous 13 km crossing to an island off the Icelandic coast. ABB will not only supply the drive and energy storage (a 3 MWh battery pack) but also the generators, transformers, switchboard, power and energy management system, and the energy storage control system. An ABB dockside Onboard DC Grid™ system recharges the battery in just 30 min via a DC connection. Unlike the Niagara boats, this ferry has a backup diesel generator, though it is foreseen that it will be used only rarely.

The Maid of the Mist Corporation's decisive move toward e-mobility and the comprehensive palette of ABB solutions for marine vessel electrification described above not only signal the beginning of a new era in transportation, but they also underline ABB's commitment to power the world in a sustainable fashion. Reducing emissions at Niagara Falls is not only important for this national natural treasure, but also important in proving that the technologies enabling sustainable mobility are already available today. ●

References

[1] D. Siegrist, "125 years and a centennial: ABB celebrates 125 years' existence in Switzerland and 100 years of corporate research," ABB Review 3/2016, pp. 7–12.

[2] M. Kajava, "MARANDA – Aranda goes hybrid." Available: <http://search.abb.com/library/Download.aspx?DocumentID=9AKK107045A7585&LanguageCode=en&DocumentPartID=&Action=Launch>

[3] "ABB and Ballard Power Systems to jointly develop zero-emission fuel cell power plant for shipping industry." Available: <https://new.abb.com/news/detail/5360/abb-and-ballard-power-systems-to-jointly-develop-zero-emission-fuel-cell-power-plant-for-shipping-industry>

[4] K. Vanska, S. Kanerva, J. Bogen, G. Skinner "Welcome aboard hydrogen – QRV?" ABB Review 4/2019, pp. 18–23.

E-MOBILITY

Welcome aboard hydrogen – QRV*?

With hydrogen fuel coming of age, marine industry experts continue to explore alternatives to fossil fuels to meet the needs of a diverse and developing industry. Hydrogen fuel cells are regarded as a promising option for radically reducing vessel greenhouse gas emissions. Combined with more established shipboard battery technology, they have the capability to enhance energy density in zero-emission marine operations while also improving vessel endurance.



Photo: Adobe Stock

* Q codes are used in maritime telecommunications as message abbreviations. QRV is short for "Are you ready?" and QUK is short for "Can you tell me the condition of the sea observed at... (place or coordinates)?".



— In April 2018, IMO's Marine Environment Protection Committee (MEPC) adopted an initial strategy on the reduction of greenhouse gas emissions from ships. In the mid- and long-term, new marine propulsion technologies and low-carbon and zero-carbon fuels will be needed to decarbonize the sector.

— **Klaus Vanska**
Sami Kanerva
 ABB Marine & Ports
 Helsinki, Finland

klaus.vanska@fi.abb.com
 sami.kanerva@fi.abb.com

Jostein Bogen
 ABB Marine & Ports
 Billingstad, Norway

jostein.bogen@no.abb.com

George Skinner
 Ballard Power Systems
 Vancouver, Canada

To achieve the International Maritime Organization's (IMO) target to cut annual emissions from shipping by at least 50 percent by 2050 from the 2008 levels [1], the industry will need to consider multiple future fuel sources. The need cannot be met by just one or two, and each alternative fuel will have their own markets and uses. The challenge is to help customers understand the wide range of alternatives, and the complexity of selecting the best one for their needs. Different fuels are available depending on regions, market demands, operational and trading patterns, and more.

Among these are biodiesel, fuels from biomass including waste, and renewable sources including solar, wave and wind. It's possible to bind the electricity generated by renewables and use it to split molecules and create hydrogen. It's also possible to generate synthetic fuels, ammonia, methane or methanol.

— **Hydrogen fuel cells have the capability to enhance energy density in zero-emission marine operations while also improving vessel endurance.**

Production of these fuels is largely based on the fossil fuels of today, but all of them can be renewable in the future. Tried and trusted internal combustion can still be used to burn several of the alternative fuels, such as ammonia, though engine modification would be required in most cases. Fuel cells are another option. Within the scope of renewables, the costs of different fuels may be similar, but the differentiators will be in the way in which they are used, as well as their availability.

A new position

All fuel alternatives have their inherent challenges: for example, hydrogen has very low energy density and needs to be compressed and cooled so that it is practical to transport and store it. Ammonia is highly corrosive and needs to be cooled as well, and methanol is toxic. Each fuel requires its own



01

transportation and storage technology. There is no straightforward blanket solution. To meet the coming demand several countries are conducting hydrogen studies, each suited to their particular situation. The UAE has announced hydrogen production using solar power, while Iceland is using geothermal energy. But each of these countries still faces challenges in transporting the energy to where it will be used.

ABB and Ballard Power Systems have recently signed a Memorandum of Understanding (MoU) on developing next-generation fuel cell systems for the marine industry →1. The new fuel cell power system will be jointly designed, developed and validated by ABB and Ballard Power Systems, and is anticipated to play a significant part in accelerating the industry-wide adoption of sustainable solutions for marine e-mobility. Together with Ballard, ABB will leverage the existing kilowatt-scale fuel cell technologies to create a pioneering megawatt-scale solution suitable for powering larger ships →2. With a scalable solution in the megawatt range, the new system will fit within a single module no bigger in size than a traditional marine engine running on fossil fuels.

As a global provider of innovative clean energy solutions, Ballard Power Systems has years of experience in the deployment of hydrogen fuel cell systems for land-based use, with the first developments dating back to 1983. Ballard's work with marine hydrogen as a fuel goes back to their role as advisors to the Canadian military.

"The Canadian Navy has had fuel cells in their submarines since 1993", says George Skinner, safety expert with Ballard Power Systems. "This fact alone demystifies hydrogen as high risk – the last place you want a dangerous fuel on board is in a steel tube hundreds of meters under the sea."

—
The objective is to make a failsafe fuel cell power plant. This has been done on land, so it can be done at sea.

Some people's ears prick up at the mention of hydrogen as a fuel. However hydrogen is not necessarily more dangerous or safer than other fuels – just different →3. According to Skinner, "hydrogen has a less explosive energy, it burns quicker and colder, and it disperses straight up. It is very easy to ignite, so it is important to prevent leaks, install sufficient detection systems, and always have enough ventilation. The International Code of Safety for Ships using Gases or other Low-flashpoint Fuels [2] already lays out ways to deal with it, and DNV GL is looking into improved piping systems. New codes and standards are also under development."

DNV GL, a leading global quality assurance and risk management company, published the first rules for hydrogen on ships in January 2018. The rules are linked into codes and standards for other

—
01 ABB and Ballard Power Systems are jointly developing zero-emission fuel cells for the marine industry.

—
02 Representation of a PEM hydrogen fuel cell system.

industries with a longer hydrogen history. “The basic principles are the same for liquefied natural gas (LNG) and other low flashpoint fuels”, says Skinner. “Handling techniques for liquid gas are already well known, so the technology is broken in. The real challenge now is developing the infrastructure.”

Ultimately, the objective is to make a failsafe fuel cell power plant. This has been done on land, so it can be done at sea. Fuel cells have a long life and they are relatively low maintenance. Skinner is of the opinion that “the main problems with hydrogen have been connected to perceptions from the past, such as negative associations with the Hindenburg case [the German passenger airship LZ 129 Hindenburg event occurred on May 6, 1937, as it caught fire and was destroyed] – and the hydrogen bomb. In fact the hydrogen bomb is a nuclear reaction, so this is a total misrepresentation. Hydrogen is ubiquitous in industry, aerospace, and many forms of transportation.”

Skinner points out that NASA has decades of experience using hydrogen as rocket fuel, and

Viking Cruises have been in discussions with NASA to learn more about loading the fuel. Ballard Power also runs its own fuel cell lab on liquid hydrogen. “We have been getting deliveries twice a week for 20 years. Getting it from shore to ship will be basically the same thing. After all,” he smiles, “it’s only rocket science.”

“Once you are set up with hydrogen, you are flexible. Regardless of how it is produced – by solar, gas, hydropower, or wind – hydrogen is the energy carrier. A good example is Denmark”, Skinner says, “where they have periodic surplus power from wind that they convert into hydrogen for later use.”

—
Fuel cells combined with batteries are an important part of ABB’s “Electric. Digital. Connected.” vision for a sustainable maritime future.

Skinner sees the trend toward marine hydrogen fuel as an exciting opportunity. “The quantities in marine will get energy companies engaged, which will solve the infrastructure conundrum. And once hydrogen is available in ports for ships it can be used to fuel trucks and other movers of goods and people. The onset of marine hydrogen will be a major catalyst for kicking off the hydrogen economy. As a first step, the cruise industry will likely look toward a hybrid solution, using fuel cells to power hotel functions in ports and when in protected fjords. Eventually they could apply hydrogen to provide power for the entire vessel, including propulsion, and hydrogen-powered fuel cells produce water that can be used for other purposes on board.”

HYBRIDship

Fuel cells combined with batteries are an important part of ABB’s “Electric. Digital. Connected.” vision for a sustainable maritime future. In Norway, ABB and the SINTEF Ocean laboratory in Trondheim are conducting test to assess how fuel cells and batteries can best function together for short-distance ferry operations, and how Norwegian shipyard Fiskerstrand can integrate them with other engine room systems. The tests will also provide insight into the introduction of hydrogen fuel cells for future reviews of the rules covering shipboard use of hydrogen.

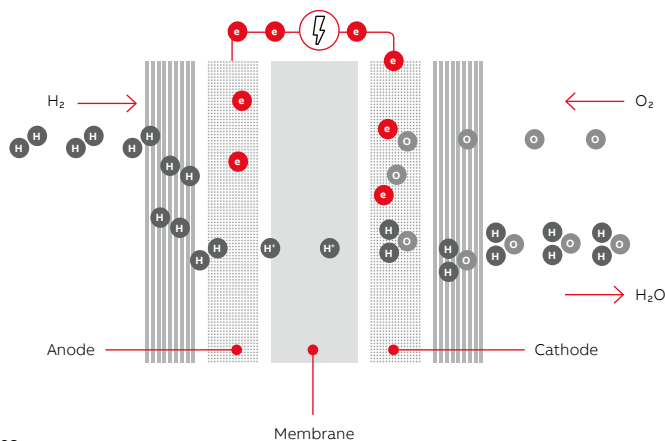

— DEMYSTIFYING HYDROGEN

- Hydrogen is the lightest element known to mankind. It is tasteless, odorless, and non-toxic.
- Using hydrogen as fuel, the proton exchange membrane fuel cells (PEM) separates electrons and protons, with protons passing through and electrons used as electrical output.
- PEM fuel cells operate at a lower temperature, are lighter and more compact than their solid oxide counterparts.
- Hydrogen very quickly disperses in air, rapidly dropping below flammability level.
- Hydrogen gas does not have a lot of “bang-power” per volume compared to other common fuels.
- Hydrogen’s very rapid burn rate means that personnel, equipment or facility exposure to heat or flame will be extremely brief.
- Objects near a hydrogen fire will receive very low levels of radiant heat.
- Hydrogen has a high auto-ignition threshold, but the spark-energy needed to ignite hydrogen can be far less than for other fuels – thus bonding and grounding are important.
- Hydrogen is converted directly to electricity and heat without combustion.

03

—
The joint ABB/SINTEF development program will also focus on finding solutions to support the hydrogen supply and bunkering infrastructure.

The HYBRIDship project, started in 2017 and driven by Fiskerstrand Holding, is supported by Norway’s “Pilot-E” technology accelerator program funded by the Research Council of Norway, Innovation Norway and Enova Norwegian government enterprise. ABB’s system integration know-how, combined with SINTEF Ocean’s long-standing experience in the field of marine propulsion systems, as well as SINTEF Industry’s expertise in fuel cells technology are vital elements in the success of this project. The project is envisaging a zero-emissions passenger ship retrofitted with fuel cells operating on a domestic route by the end of 2020 and battery power will certainly be key to meeting Norway’s target for zero ship emissions in the fjords from 2026 →4.

The tests will simulate the conditions the ferry is expected to encounter on a high frequency 10km route to ensure that the propulsion systems including fuel cells are robust enough for repetitive, short-burst service duties. The project is a major step towards the practical use of the hydrogen fuel cell as a maritime propulsion technology. One of the major beneficial outcomes of these tests will be in defining the optimum engine room configuration for hydrogen fuel cells to be installed, and to work day-in, day-out, with other systems on board.

The joint ABB/SINTEF development program will also focus on finding solutions to support the hydrogen supply and bunkering infrastructure. In addition, outputs from the new tests are expected to accelerate Norwegian Maritime Authority (NMA) work in modifying regulations to better accommodate and approve hydrogen as a maritime fuel.

—
03 Factbox: Demystifying hydrogen.

—
04 The world's first conversion of a passenger ship retrofitted with fuel cells for zero-emissions, is expected to be operating on a domestic route by the end of 2020.

Towards autonomous shipping

In addition to their sustainable profile, fuel cells are a good match for autonomous shipping. Today's propulsion systems are not ready to go fully autonomous due to the maintenance requirements of mechanical power trains, but fuel cells are well suited, as there are no moving parts, and little to no maintenance. This makes fuel cells suitable for the overall autonomous solution, because they can go longer without the need for on-site human intervention.

From a time perspective, alternative marine fuel solutions are in a demonstration phase at the moment. Increasingly strict environmental regulations are the main drivers of the development. Early adopters and R&D programs are showing the way, as are several ferry projects around the world.

There is also a growing interest in demonstrating the feasibility of fuel cell technology for the cruise industry, with the first step being to power hotel functions, emission free, also in port.

—
Fuel cells are a good match for autonomous shipping as there are no moving parts, and little to no maintenance.

With regulations setting the agenda, it is expected that a number of alternative fuel solutions should be realized in the shipping industry fairly soon, even as early as 2025. Once renewables are used to produce hydrogen for fuel cells and stored energy for batteries, the entire chain can be clean and then one may all hope that the response to the question QUK*? will be: Clear and calm. Out. •

References

[1] Note by the International Maritime Organization to the UNFCCC Talanoa Dialogue, "Adoption of the initial IMO strategy on reduction of GHG emissions from ships and existing IMO activity related to reducing GHG emissions in the shipping sector," IMO Headquarters, London, UK, Resolution MEPC.304(72), 13 Apr. 2018.

[2] International Maritime Organisation, "International Code of Safety for Ship Using Gases or Other Low-flashpoint Fuels (IGF Code)" [Online]. Available: <http://www.imo.org/en/OurWork/Safety/SafetyTopics/Pages/IGF-Code.aspx>. [Accessed: July 10, 2019].



04

E-MOBILITY

The electric bus – range is a matter of perspective

Because they travel a set route and schedule, range anxiety need not be an issue for electric buses. Far more, the question is: How fast, how and where can the battery be recharged? Efficient recharging reduces electric bus operating costs. What, then, are the core elements of an electric bus charging solution?



Photo: TPG



— In 2016, ABB was awarded a contract by TPG and Swiss bus manufacturer HESS to provide flash charging and onboard electric vehicle technology for 12 TOSA buses. The electric TOSA buses are as flexibly deployable as diesel buses.



Alexandre McCraw
ABB Ltd.
Baden, Switzerland

alexandre.mccraw@
ch.abb.com

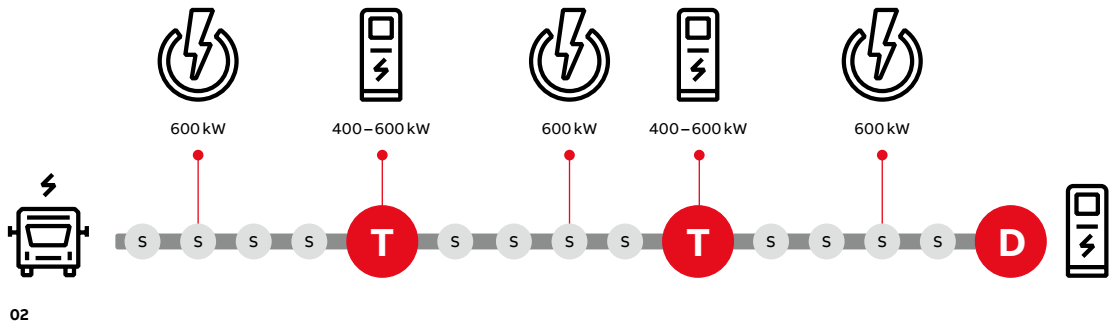

How far can an electric bus travel before it needs to recharge its batteries? The question comes naturally when thinking about electric cars, especially as the essence of having a car is the freedom to go anywhere, at any time. A bus, however, does not go anywhere at any time, it goes to a specific place, along a specific route and at a specific time, and repeats that day-in and day-out according to a published schedule. The real question, therefore, is not how far it can go but how fast can it recharge before going there again. This article looks at why flash recharging reduces the overall cost of operating an electric bus line and explains the core elements of a solution.

Bus cost

Achieving a low total cost of ownership (TCO) is about operating an electric bus line with only as many vehicles as are needed and for that, having a one-to-one correspondence with the diesel bus equivalent solution is the key. This means having the same schedule, the same layover time, the same numbers of buses and drivers, and the same passenger capacity as a diesel fleet.

—

Achieving a low TCO is about operating a bus line with only as many vehicles as are needed.

Buses, whatever their energy source, are costly to maintain. Conversely, infrastructure, once installed, has significantly lower maintenance costs and longer operational life. Bus operators can, therefore, lower the TCO of their electric fleet with a solution that optimizes the number of vehicles by maximizing the versatility of their infrastructure and by introducing common battery sizes on their bus fleet.

Battery charging strategies

Current charging strategies, whether overnight at the depot or opportunity charging at terminals, are governed by the time needed to charge the vehicle and the constraints imposed by the schedule.

In the case of depot charging, bus operators rely on the battery having sufficient capacity to complete the route. Battery size, however, negatively impacts passenger capacity and increases the cost and weight of the vehicle. Up to 45 percent of the cost of an electric bus with a depot charging strategy comes from the battery.

For opportunity charging strategies, with charging stations at the line terminals, the vehicle must charge in a period shorter than the scheduled layover time. Layover times exist to provide drivers with a break but also to provide delay buffers. During peak periods when layovers are shorter, line operators often face a dilemma: Only partially recharge the battery to keep to schedule and push the battery into deep discharge, or abandon the schedule to enable a full charge? Opportunity charging strategies only allow sufficient charging time by having more buses and drivers and more terminal and depot charging stations. These additional resources increase space requirements, energy consumption and cost. In other words, if charging is not fast enough, schedules suffer and/or costs are high.

Understanding the trade-offs

The cities of Geneva in Switzerland and Nantes in France understand the trade-offs involved in electric bus charging. Both municipalities have implemented an electric bus system that optimizes the number of vehicles and makes the most of charging opportunities. As both cities have different operating realities and different electrical grids systems, the systems they chose are likewise different to leverage those local opportunities. Regardless of these differences, there are core elements that both share.

—
02 Conceptual scheme showing that charging takes place at regular stops (S) in addition to the terminals (T) and depot (D).

—
03 Onboard versus traditional charging.

For instance, the two cities rely not only on charging opportunities at the terminals and depot but also on others along the route, while passengers embark and disembark →1–2. Charging along the route at selected stops, so-called flash charging:

- Ensures that batteries are kept in a high state of charge.
- Reduces the need for long charging periods.
- Extends battery life by avoiding deep discharges.

In periods of congested traffic, the vehicle gets most of its energy at stops along the route, while during off-peak operation, the vehicle recovers mostly at the terminus.

The benefits of onboard charging

The chargers at the terminals and along the routes in Geneva and Nantes provide 400 to 600 kW to maximize energy level recovery. Such an infrastructure is only effective when combined with a battery capable of absorbing such a high-power charge. That is why the vehicles are equipped with lithium titanate oxide (LTO) batteries that charge quickly and can operate at up to “10C.” 10C refers to the C-rate, a standard measure of how fast a battery can be charged or discharged. The higher the C-rate, the faster the charge or discharge. This measure is a key differentiator for ABB: A large battery is only helpful if it charges and discharges without impact on the schedule.

The Nantes and Geneva buses also both use onboard charging →3. In such systems, the overhead rail provides a constant DC voltage and the equipment mounted in the vehicle transforms this to a form useable by the auxiliaries and motors. By reversing the flow of power between battery and motor, the DC fed from the overhead rail can be used to charge the batteries.

—
The two cities rely not only on charging opportunities at the terminals and depot but also on others along the route.

This avoids breaking the mission-critical communication between the battery and the onboard charger at charging points. On-board charging thus keeps interfaces between the vehicle and charger to a simple physical contact check with no further communication needed.

Another element the Geneva and Nantes buses have in common is a fast-operating pantograph that enables the bus to connect to the charger in under 1s →4,5. Predeployment of the pantograph on nearing a charging point and automatic alignment with the charging hood allows drivers to approach the charging stop as they would any

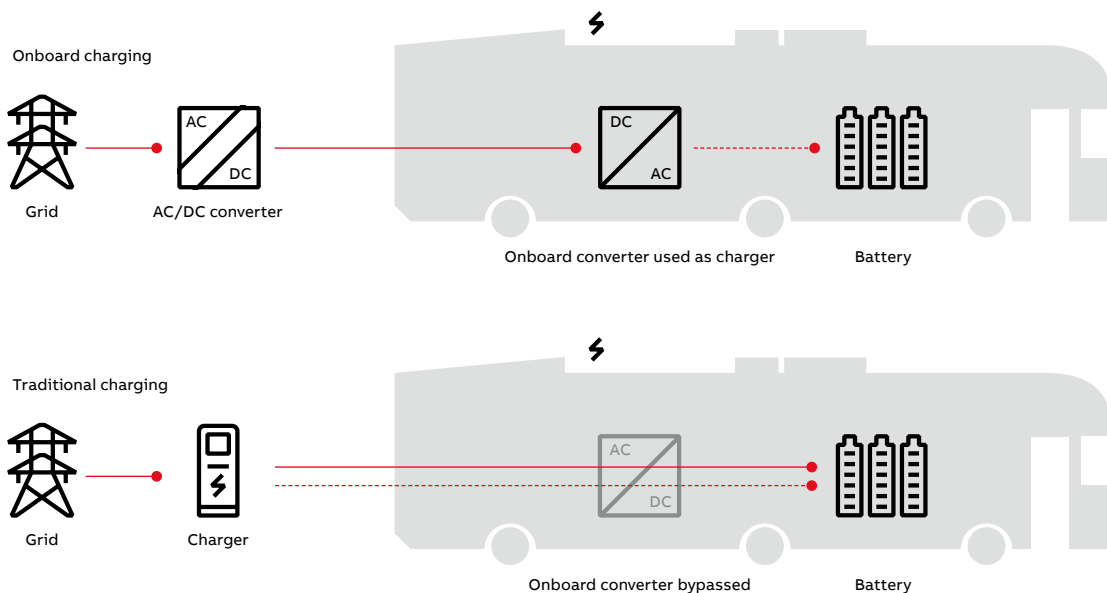

—
 04 Fast battery charging via a pantograph is performed at the stop and at the terminal.

—
 05 A TOSA flash charger with an energy storage unit in Geneva. The Nantes line did not require stored energy at bus stops.

—
 06 Key elements of an electric bus system.

—
 07 Charging fast and often is an excellent way to minimize cost and ensure schedules are met on busy routes or in challenging weather.

other and speeds the process. Each charging second gained helps reduce the number of flash charging points required along the route as well as the time needed to recharge at the terminal. These savings give the line operator more flexibility, improved schedule recovery times during peak periods and, thanks to common vehicle battery sizes, the ability to re-deploy any bus to any line and easily handle new demand.

Keeping to the schedule

Choosing the right battery charging philosophy keeps electric bus costs low →6. Depot charging strategies require larger, costlier batteries that reduce passenger capacity; opportunity charging strategies quickly impact layover times and require more vehicles and more infrastructure if schedules are to be maintained. The best chance of fulfilling timetables and keeping the commitment to passengers during peak periods, challenging weather, etc. →7, while keeping TCO down, is to charge faster than the layover time and as often as possible, as is done in Geneva and Nantes.

—
 Geneva and Nantes buses have in common a fast-operating pantograph that enables the bus to connect to the charger in under 1 s.

When it comes to electric buses, the focus should not be on the range but on keeping to the schedule. If the recharging is done wisely, an electric bus network can be run not only with a low TCO but also with environmentally friendly credentials, which is of benefit to all. •

04



Flash charging at selected points along the route



LTO batteries



High-power infrastructure



Onboard charging



Fast-operating pantograph

06



05



07

E-MOBILITY

The future of the power grid in the coming era of e-mobility

Between now and 2040, Europe must implement a series of practical steps that will make it possible to meet peak demand requirements resulting from the widespread adoption of electric vehicles. With this in mind, ABB has conducted an in-depth analysis of anticipated power needs in key European economies. The company's recommendations regarding power transmission and distribution and the challenges associated with developing cleaner and more resource-efficient transportation are outlined in this article.

—
Thierry Lassus
 ABB Sécheron SA
 Power Grids – Segment
 Transportation
 Geneva, Switzerland

thierry.lassus@
 ch.abb.com

Alexandre Oudalov
Adrian Timbus
 Power Grids Business
 Zurich, Switzerland

alexandre.oudalov@
 ch.abb.com
 adrian.timbus@
 ch.abb.com

Not since the times of our great, great grandparents has there been a transformation in transportation such as we are witnessing today. Roughly 120 years ago the transition from horses and buggies to motorized vehicles was barely on the horizon, yet by 1908 there were already as many automobiles on the streets of New York City (100,000) as horses.

—
 The impact of air pollution on health insurance and sick leave in the EU is estimated at 100 billion euros per year.

But that transformation was not simply a question of exchanging one type of motive power for another; it was, more profoundly, a question of coming up with an entirely new infrastructure. For instance, before cars and trucks could be of much practical use, asphalt production had to be developed and ramped up; roads had to be paved; a system of street signs, road markings and traffic laws had to be developed; gasoline production had to be improved; and society itself had to be retooled as stable boys made way for gas station attendants, carriage makers for engineers; and blacksmiths, harness makers, farriers and saddle makers for mechanics and assembly line workers.

Today, society is in the early stages of a similarly profound paradigm shift – a shift that will see a transition from internal combustion engines fired by fossil fuels to electric mobility. As people, businesses and public transport operators progressively adopt e-mobility as a primary transport technology, it will become increasingly necessary to invest in infrastructures and technologies that support and enable this transition, the most prominent of which is how power will be provided to charge the millions of new electric vehicles (EVs) that will soon take to the roads →1.

Driving the transition

Three major trends are driving the transition toward e-mobility. The first of these is the need to reduce greenhouse gas emissions. Within the context of the battle to limit climate change, the Paris Agreement, which was signed in 2016 by 174 countries, is designed to limit the increase in global average temperatures to well below 2° C above pre-industrial levels. The transport sector, which today accounts for 28 percent of CO₂ emissions in France, for instance, will notably have to reduce its emissions by 29 percent by 2028 in comparison with 2015 figures.

The second major trend driving demand for e-mobility is the need to reduce other types of emissions and pollutants that are harmful to human health and the economy. Air pollution by



01

— 01 A high-speed charging station. The key technologies supporting the transition to e-mobility will be those that make it possible to provide sufficient power to charge the millions of new electric vehicles (EVs) that will soon take to the roads.

nitrogen oxide and particulates is largely attributable to the transport sector. According to the European Environment Agency, particulate matter caused 391,000 premature deaths annually [1]. The economic impact of air pollution is also significant: more than 100 billion euros per year in costs associated with health insurance and sick leave, not to mention reduced agricultural yields and the degradation of buildings, bridges, etc. as a result of exposure to these pollutants.

Third on the list of forces driving the transition to e-mobility is the need to increase the attractiveness and livability of cities and regions. In addition to air and noise pollution, congestion in urban centers means lost time and productivity for users. An improved mix of public-private transportation, autonomous EVs and increasingly synchronized and optimized traffic management based on vehicle-to-infrastructure technology would reduce these stresses and help cities to attract companies, start-ups and creative people who demand efficient transport infrastructures and a healthy environment.

EV markets and the grid: growing up together

Considering the powerful environmental, economic and social forces driving demand for an EV-based transportation system powered by renewably generated electricity, ABB has carried out an

in-depth analysis of multiple scenarios for anticipated power needs in Germany covering the years 2020, 2030 and 2040 – a period that is likely to be marked by the progressive adoption of e-mobility. Additional analyses were carried out for France and the United Kingdom.

— **ABB has carried out an in-depth analysis of anticipated power needs in Germany covering the years 2020, 2030 and 2040.**

ABB's analysis indicates that, even if existing power generation systems can mostly cope with EV charging needs, there will be instances – primarily at times of peak demand on days when generation from renewable sources is limited – when demand outstrips available supply or overburdens existing transmission and distribution networks →2.

To ensure continuous and reliable service, cross-border and regional grid upgrades and expansions will be necessary in many cases in order to facilitate the exchange of renewably generated energy across geographies that have complementary patterns.

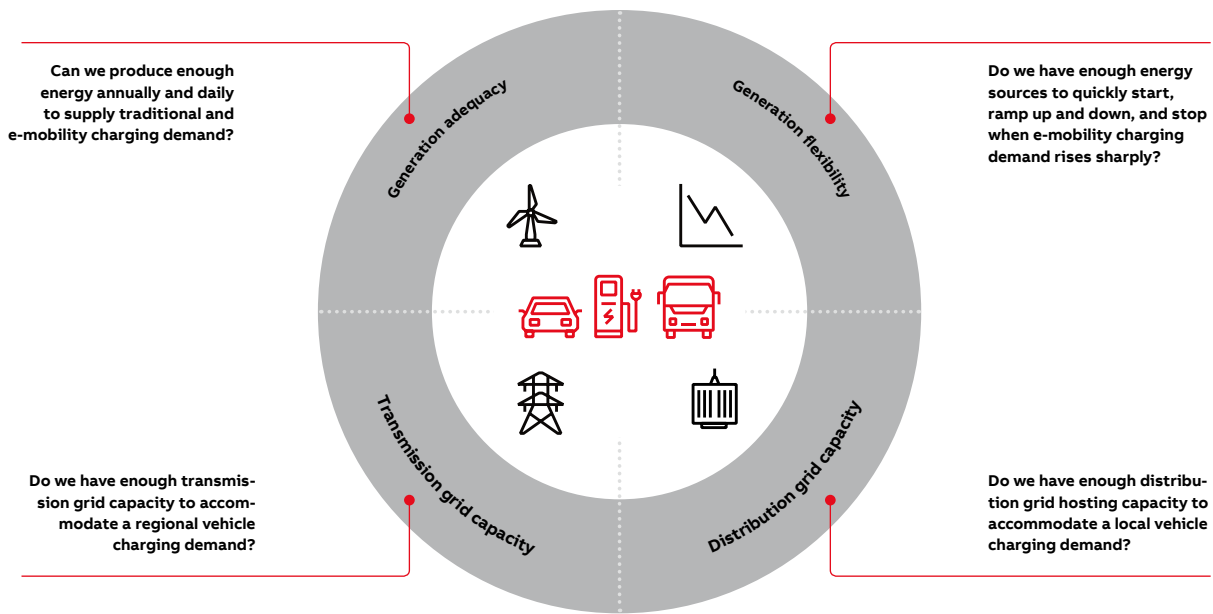

02

— 02 Capacity considerations that will need to be addressed in order to minimize disruption and maximize an orderly implementation of e-mobility.

— 03 Factbox: A commitment to electric mobility.

There are also several existing solutions that can limit the potential negative impacts of the mass adoption of e-mobility on grids. Among these are solutions that shift EV charging to non-peak hours or to the times when renewably generated energy is predicted to be in over-supply. For example, current systems for the charging of electric buses are already capable of managing overnight charging at a depot so that not all buses are charged simultaneously [2] →3, 4.

It would not be difficult to apply similar techniques to charging systems for other vehicles as well. A scheduling regime would reduce the risk of overloads triggered by changing tariff periods, although it may be necessary to provide a financial incentive to private users to charge their vehicles later at night, presumably by reducing the cost of power at off-peak hours.

Energy storage systems are also likely to play a growing role in our power systems, particularly as pressure grows to develop methods to store power generated by renewable sources. At the level of local distribution networks, small-scale storage systems make it possible to significantly reduce immediate loads on grids, as they make it possible to spread the transfer of power from the grid over a longer interval. Ever more storage technologies, both large and small in scale, are being developed or are already heading for market introduction.

Furthermore, solutions are being investigated that involve using the battery packs of EVs themselves

as components in a distributed power storage system. Since private vehicles are typically parked and not used 95 percent of the time, there is some logic in attempting to use them as sources of reserve energy that can be mobilized to support the power grid at times of peak demand. This would require the use of a bidirectional charging interface – an approach that could reduce the total cost of EV ownership by enabling owners to sell power from the vehicle to the grid at times of their own choosing.

Solutions are being investigated that involve EV battery packs as components in a distributed power storage system.

In addition, once an EV has come to the end of its useful life, its batteries could serve a secondary purpose in stationary applications to provide power storage and shift demand into non-peak periods.

Another technique that can be used to spread out the charging of vehicles relies on the centralized management of charging stations. A virtual power plant, or VPP, consists of centralizing and optimizing the operation of a number of assets. A VPP can integrate charging stations, demand sites, power generation sites and energy storage systems, and then optimize and prioritize consumption over an entire range of

A COMMITMENT TO ELECTRIC MOBILITY – ON LAND, SEA, AND IN THE AIR

—
Geneva's first electric bus. The bus uses flash chargers along routes to partially recharge batteries and thus reduce charging time at terminal stations.

ABB is actively working to meet the challenges posed by the electrification of mobility. To do so, it is investing heavily in research and development that is geared toward constantly improving the energy efficiency of in-vehicle and on-board technologies, as well as charging solutions. The company is also committed to the identification and development of new opportunities for services offered by the digitization of transportation systems.

High-speed rail

ABB has contributed key technologies to all major forms of transportation. In the rail sector, ABB systems made it possible for France's TGV high-speed train to achieve a record 575 km/h in 2007. In 2012, in Philadelphia, the company implemented the world's first train-braking energy recovery system based on the use of way-side battery energy storage. And in 2016 ABB electrified the Gotthard Tunnel in Switzerland – the world's longest railway tunnel.

Fast charging for buses, cars and boats

When it comes to public and private road-based transportation, ABB technology is helping to cut CO₂ emissions. For instance, working in close cooperation with local authorities, the company developed Geneva's first electric bus, which is based on its "TOSA" (Trolleybus Optimisation Système Alimentation) "flash charging" technology [1]. The technology uses flash chargers along routes to partially recharge batteries and thus reduce charging time at terminal stations. In 2014, ABB received a "smart Award" at the Smartgrid Paris trade show for the technology.

Since then, ABB has deployed one of the first ultra-fast charging stations (150 kW) for electric vehicles in the United States, has launched the world's first 24-meter electric bus based on flash charging technology, and is the first company anywhere to have deployed a 350 kW charging station [2]. The company has also delivered the first 100 percent electric ferry, which is now operating between Denmark and Sweden. The ferry can be charged in less than 10 minutes when docked.

In 2016, in a partnership with Volvo Buses, ABB automated two fast charging systems to serve electric buses in Namur, the capital city of Wallonia (Belgium). The systems are based on "opportunity charging," where, instead of returning a bus to a depot to connect to an individual charger, the bus is recharged in minutes each time it arrives at an end station. This allows buses to be outfitted with a smaller, lighter battery pack, which increases passenger capacity. Because they are not returned to a depot for charging, the buses are able to run more routes. ABB has since sold 10,500 DC high-speed chargers across 73 countries worldwide [3].

Electric flight

Only a few years ago, could anyone have imagined being able to fly around the world in a solar-powered plane? Solar Impulse did just that with the help of ABB, the result of a shared vision between two adventurers and a team of ABB engineers and scientists. •

References

[1] A. McCraw, "The electric bus - range is a matter of perspective", ABB review 4/2019, pp. 24–28.

[2] <http://www.abb.com/cawp/seit-p202/45ecf5b55b2ab-524c125829d002c21a9.aspx>

[3] <https://new.abb.com/news/detail/24231/abb-to-supply-high-power-charging-for-new-era-of-e-mobility-in-scandinavia>



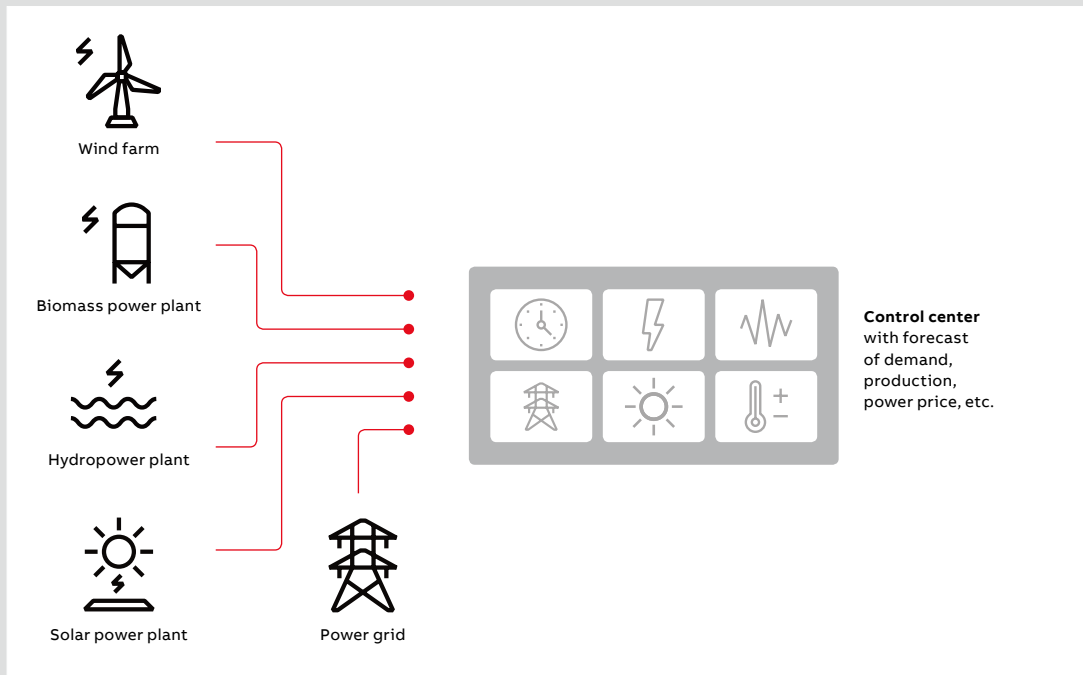

HOW THE GRID CAN MEET THE DEMANDS OF ELECTRIC MOBILITY

Virtual power plants (VPP) provide an entirely new toolbox with which to respond to and optimize energy supplies over a range of assets.

As electric mobility becomes increasingly important, it will have to be implemented in harmony with technological improvements in electrical power grids, which are themselves rapidly changing in response to the massive integration of renewable energy sources. Here are three examples of what can be done.

Sequential charging for electric bus depots

Tomorrow's buses will be powered by rechargeable batteries. Considering the huge amount of power this will require, a great deal of charging can be expected to take place when demand for electrical energy is low. To optimize their investments, transport authorities will benefit from pooling the use of chargers for several buses. With this scenario in mind, ABB has developed chargers with a capacity of up to 150 kW that can successively charge up to three buses. Known as sequential charging, this process can be programmed remotely. This spreads the charging power throughout the night, while guaranteeing a full charge for the following day.

Energy storage to spread power demand

As part of the implementation of an electric bus line in Geneva, Switzerland, ABB has integrated batteries in selected bus stops equipped with

flash charging stations. These "buffer" batteries recharge between two bus charging operations at a power of about 50 kW; however, they discharge at a power of 600 kW in about twenty seconds. This major innovation reduces peak power demand on the local distribution grid to less than one tenth of what it otherwise would be. The same concept could be applied in many other areas, including high-speed charging stations for electric vehicles. Such systems also hold the promise of ensuring improved energy quality, voltage support, and power reserves.

Centralized management of charging stations

Virtual power plants (VPP) can integrate charging stations, demand sites, power generation sites and energy storage systems, thus providing VPP operators with an entirely new toolbox with which to respond to and optimize energy supplies over a range of assets. The use of a VPP has enabled the energy company Stadtwerke Trier in Germany to guarantee the charging of electric vehicles using 100 percent renewable electricity. The platform has also allowed the operator to provide services to the local grid such as voltage adjustments and power reserves. •

—
04 Factbox: How the grid can meet the demands of electric mobility.

05 Potential for future power shortages on days of low output from renewable energy sources in Germany.

assets. The use of such a platform enabled Stadtwerke Trier, a utility in Germany, to ensure that EVs would be recharged using exclusively renewable electricity.

Key recommendations

It should be possible to modify and strengthen today's generation, transmission and local distribution infrastructure to serve tomorrow's needs without undue expense or disruption.

With respect to generation, future developments should be carried out with an eye to flexibility →5. For instance, unlike combined-cycle gas turbine plants or coal-fired plants, open cycle gas turbine plants can be started and stopped on short notice and with little wear and tear on equipment. Their flexibility would make them vitally useful in a situation when base load plants and renewables need to be supplemented to meet peak demand.

Transmission networks will continue to expand in the years ahead, largely in response to the rising profile of renewable energy.

The digitization of power grids →6,7 is already playing a key role in the energy revolution and is expected to play an even greater role going forward. Extensions and bolstering of the existing transmission network will serve the purpose of integrating grids and new renewable sources, as well as of enabling greater versatility of the sort that can support new demand patterns.

—
A virtual power plant can integrate, optimize and prioritize consumption over an entire range of assets.

Local distribution networks, particularly for commercial installations, should progressively be upgraded to serve increased demand from EVs, notably at sites where large numbers of EVs can be expected to require charging.

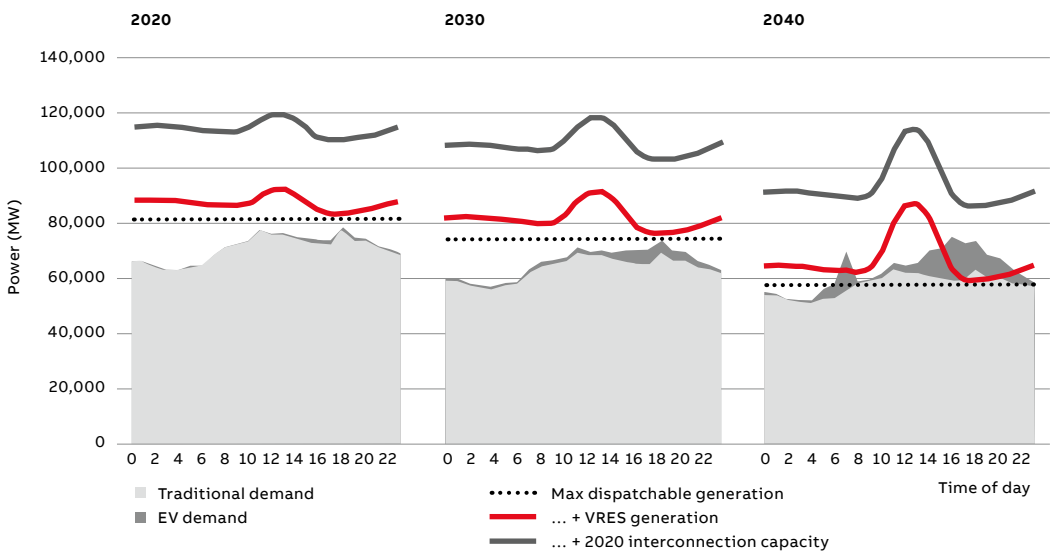



06a

—

A SECOND LIFE FOR BATTERIES – AND ADDED STABILITY FOR TOMORROW’S GRIDS

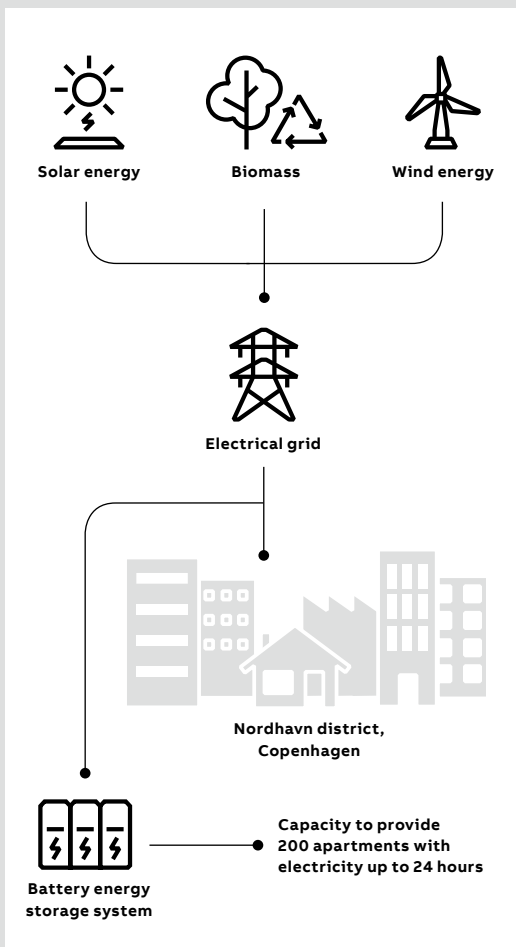

06b

—
06a An ABB battery-based energy storage solution in Denmark.

—
06b An ABB battery energy storage system, which is part of Copenhagen’s EnergyLab Nordhavn project, uses stationary batteries to provide renewably generated electricity to support the local grid during peak demand periods. In the future, such solutions could make use of batteries from retired electric vehicles.

Until autonomous driving and carsharing become common, most private electric vehicles will probably wind up being used in much the same way as their conventionally powered counterparts – in other words, they will sit in parking lots and garages 95 percent of their lives. Similarly, buses, trucks and other municipal and commercial vehicles, although more heavily used, will nevertheless be idle outside of well-defined schedules. What all such vehicles have in common – assuming they are powered by batteries – is that they hold the potential for being used as reserve power sources to support the grid →6a. What’s more, this approach allows for reducing the total cost of ownership (TCO) of all such vehicles, as well as reducing the cost of running the grid itself, as they would help to obviate peak power plants.

And one more thing: Once electric vehicles are retired, their batteries may be able to enjoy a second life in stationary applications →6b that may also help to stabilize the grid and provide a better quality of power.

Naturally, all such batteries could be charged on site using locally or remotely generated power from wind, photovoltaic, or other environmentally neutral sources. Charged this way, vehicle batteries could provide a nearly inexhaustible repository for renewably generated electricity. •

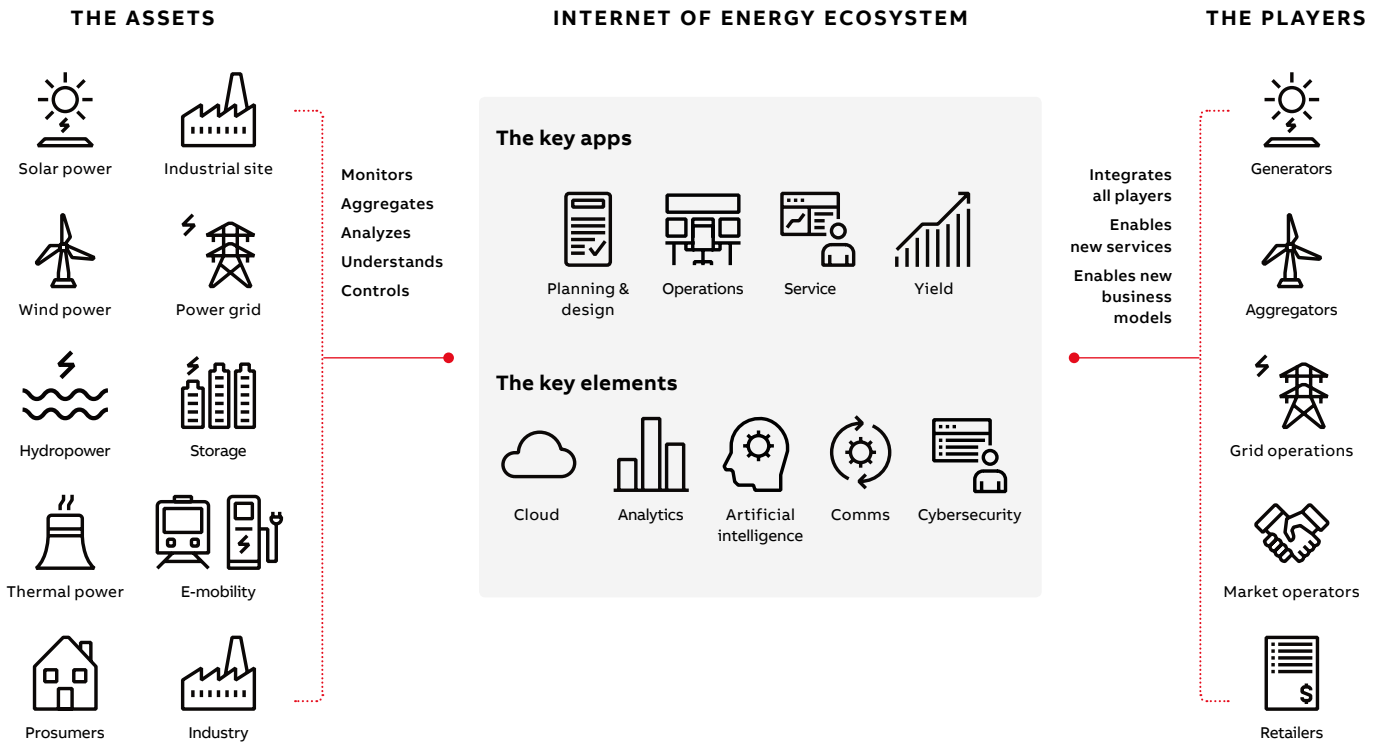

07

06 Factbox: A second life for batteries.

07 The digitization of power grids is expected to play an increasingly significant role in the development of an Internet of energy.

Furthermore, as new energy storage solutions emerge, they can be strategically deployed to serve local and regional needs in ways that will lighten the burden on generation, transmission and distribution systems. Decision-makers should continue to encourage innovative technological solutions that will limit the overall impact of charging stations on power grids.

All in all, building the infrastructure required to charge the millions of EVs that are expected to be built and sold over the next several decades represents a significant, but not insurmountable challenge. With proper planning and preparation, it should be possible to create that infrastructure at a reasonable cost, with a minimum amount of disruption, and in a manner that promotes the rapid and orderly implementation of e-mobility.

If EV penetration reaches 100 percent worldwide, total electricity demand will increase by 5 to 20 percent by 2040.

The road ahead

A gradual shift to e-mobility will not suddenly or dramatically overburden our existing power systems. In Germany, for instance, depending on factors such as population change, car ownership rates, average driving distances, and kilometers driven per vehicle, the additional electricity demand associated with EVs is expected to be 0.3 percent in 2020 and between 10 and 12 percent by 2040. Should EV penetration reach 100 percent around the globe, total electricity demand is projected to increase by 5 to 20 percent in different countries by 2040.

References

[1] <https://www.eea.europa.eu/highlights/air-pollution-still-too-high>

[2] F. Muehlon, "EV infrastructure innovation through collaboration", ABB Review 4/2019, pp. 38-43.

E-MOBILITY

EV infrastructure innovation through collaboration

The rapidly evolving electric vehicle (EV) market is driving innovation in EV technology and associated infrastructure. ABB maintains its position at the forefront of EV technology through a combination of in-house research and development (R&D) investment and collaboration with expert partners.



Frank Muehlon
ABB E-Mobility Infrastructure Solutions
Heidelberg, Germany

frank.muehlon@
de.abb.com

Growth in the EV market is undoubtedly gaining pace, with some commentators predicting that by 2040 there will be 559 million EVs on the road and 33 percent of the global fleet will be electrically powered [1]. Already, however, much progress has been made in the journey toward this more sustainable transport landscape. As evidence of the trend, ABB is witnessing surging demand for public and private EV charging solutions, having sold more than 10,500 DC fast chargers across 73 countries by 2019. ABB is also helping stakeholders across the globe establish electric bus services that reduce human impact on the environment →1.

—

ABB's long engineering history and strong R&D culture help the company pioneer e-mobility technologies.

To deliver its vision of a sustainable, emission-free future – and satisfy increasing demand from the EV field – ABB needs to continually innovate and develop new solutions. ABB's long engineering history and strong R&D culture are significant factors in the company's ability to advance pioneering technologies in the area of electric mobility. For example, ABB was a joint founder of the CHAdeMO and CCS alliance charging

standards. ABB launched its first DC fast charger in 2010, the first nationwide DC charging networks in 2012 and the first eBus charging networks in Europe in 2016.

Sustainable transportation for the future

ABB believes there are three key underlying challenges related to the delivery of sustainable transportation.

Firstly, investment in the sector must continue to increase – not only investment by vehicle original equipment manufacturers (OEMs) for the improvement of battery technology to enable greater range and cost efficiencies, but also investments by others in a widespread charging infrastructure network to satisfy growing demand. In many markets, the current situation presents a quite different picture. When one looks at the United States, for example, while 200,000 EVs were sold in 2017, there was no commensurate expansion in the country's charging infrastructure. This inadequacy causes consumers to lack confidence and suffer from range anxiety – both of which are major barriers to EV adoption. In response, ABB is collaborating with Electrify America – a subsidiary of Volkswagen Group of America that is a major owner and manager of EV infrastructure in the United States and Canada – to create the largest network of fast charging stations the country has ever seen. Secondly, attention must be focused on



01

— 01 Around the world, urban authorities are replacing diesel buses by electrically driven buses, using ABB charging infrastructure. In Singapore, ABB has helped launch the world's first fully electric, autonomous, 12-meter passenger bus.

standardization and operability. The automotive industry need only look at the electric public transport sector to see that adoption rates increase significantly with decreasing numbers of charging standards. To create positive change for the future, this approach must be replicated for passenger vehicles. Here, close collaboration between the parties involved will be crucial.

Thirdly, the world has to accept that its energy ecosystem has to evolve in order to enable an emission-free future. One key aspect of this future ecosystem is the provision of a reliable power infrastructure with low maintenance costs that enables cities to comfortably address peaks in demand. Safe, flexible and smart electrical networks are of crucial importance for the accommodation of such peaks. Here, for example, the integration of energy resources, the installation of smarter home technologies linked to private EV charging and the adoption of EVs with expanded battery capabilities

could turn homes into self-sufficient grids. Energy stored in electric car batteries could be sold back to the grid, enabling residential and commercial communities to become active participants in the energy revolution. In this context, ABB is currently developing a bidirectional DC home charger and is working closely with energy aggregators to set up reliable infrastructure solutions.

—
The world has to accept that its energy ecosystem has to evolve in order to enable an emission-free future.

Futureproofing with high-power charging

Currently, the pace of change, in both the commercial and consumer markets, is being set by the need for faster and higher-power charging. The



02

sector is, however, faced by one key challenge: the capacity of current EV batteries. At the moment, DC charging is still too powerful for most consumer vehicles, though this may change with the imminent launch of the first consumer car – as a 2020 model – capable of taking this power: the Porsche Taycan.

Even though current EV batteries do not have the capacity to store the level of charge available from a high-power charger, products such as ABB's Terra HP (high-power) charger serve the batteries of today and the higher-capacity batteries of tomorrow – and thus provide a futureproof solution that will support the development of next-generation EVs. Capable of delivering 350 kW of power, the Terra HP can add 200 km of range to an EV in a time (8 minutes) not much longer than it takes to refuel a traditional petrol-engined vehicle.

Meanwhile, for buses and trucks, the industry is currently limited to a maximum charge of 600 kW. ABB is confident, though, that there is potential for evolution here too, with 1 MW charging on the

horizon. ABB's \$10 million investment in a new R&D center, opened in September 2019, includes provision of facilities for increasing ABB's capabilities in the rapidly expanding eBus segment, which will facilitate pioneering ABB solutions in this field.

The Terra HP can add 200 km of range to an EV in a time not much longer than that taken to refuel a petrol-engined vehicle.

The power of collaboration

Hand in hand with technological progress comes the need for greater collaboration, which is a powerful enabler of innovation within the EV field. Working with other high-profile players allows ABB to push the boundaries of technology and develop new solutions. With the EV sector evolving at such a rapid rate, this need for collaboration is greater than ever. ABB continues to work



03

—
02 A Formula E car belonging to the Nissan team "Nissan e-Dams" in action during the 2019 Formula E Championship in Marrakesh.

—
03 ABB's Terra DC charger.

closely with OEMs and charge-point operators to ensure technology not only meets, but exceeds, current needs, so as to facilitate future growth. For example, ABB – in conjunction with Nanyang Technological University (NTU), the Land Transport Authority of Singapore and Volvo Buses – has just launched, in Singapore, the world's first fully electric, autonomous 12m passenger bus →1. This flagship project aims to prove that it is possible to provide fixed route and scheduled services powered by emission-free vehicles and demonstrates the remarkable advances that can be made in public transportation when the two pioneering technologies of EVs and autonomous vehicles come together.

Driving innovation

Taking the art of the possible one step further, ABB continually pushes the boundaries of what e-mobility technology can deliver. For instance, ABB is the title partner of the ABB FIA Formula E Championship series – a class of motorsport that uses only electric-powered cars. The series provides a powerful platform upon which to

test mobility electrification and digitalization technologies while showcasing their potential to a much wider audience. Fast battery charging for Formula E cars provides one good example of this innovation in action.

Latest Formula E cars have a maximum speed of 280 km/h and are capable of accelerating from 0 to 100 km/h in 2.8 s – thanks largely to significant gains in battery efficiency →2. The battery fitted to the new Gen2 racecars is heavier than the unit used in its predecessors, which raced during the first four seasons of ABB Formula E, but it has almost double the energy capacity. For a weight gain of 65 kg (to 385 from 320 kg), capacity has increased to 54 from 28 kWh – a 95 percent increase in capacity for a 20 percent weight gain. This rate of progress now allows Gen2 cars to complete a full 45 min race distance on a single charge.

This technological evolution is also becoming a reality in mainstream vehicles. For example, the Jaguar I-PACE eTROPHY series of motorsport features racing versions of the same Jaguar I-PACE electric SUVs that are now sold to consumers and that use everyday charging stations. Enabling this move from the "civil" world to the racing world required lateral thinking by ABB's technology experts, who developed a solution that would quickly recharge the batteries of up to 20 I-PACE eTROPHY race cars during breaks between practice, qualifying and races in 10 different cities on four continents during the season.

—
For a weight gain of 20 percent, capacity has increased by 95 percent.

The most obvious solution here was a DC fast charger. However, these chargers, which are designed for public use, are 2.2 m tall, making them too big to fit into the cargo holds of the jetliners that transport the series' racers and equipment around the world. Working collaboratively, a solution was developed that repackaged the functionality of a DC fast charger into a package on wheels, with a profile only 1.5 meters high →3–5.

This case illustrates well how the big challenges that e-mobility presents can be met with innovative engineering and collaboration.

The future for e-mobility technology

The e-mobility market is full of opportunities for players that range from the developers of next-generation vehicles and supporting components to charging technology providers,

charging operators, utilities and participants in the renewables sector. ABB is seeing bold portfolio diversification moves by companies – including some of the main energy providers and OEMs – that allow them to impact new parts of the value chain, particularly in the operation of charging stations. In Europe, for example, ABB is the main technology partner of, and supplier to, IONITY – a joint venture between the BMW Group, Daimler AG, the Ford Motor Company and the Volkswagen Group, with Audi and Porsche, that aims to operate a network of about 400 fast charging stations across 24 European countries by 2020. As is the case on the North American continent with Electrify America, for whom ABB is also a key technology partner, IONITY is a leader in the European high-power charging field. The sheer size and technical prowess of each of IONITY's constituent members mean that they are more joint collaboration partners who will drive the e-mobility rollout rather than simply customers. Ultimately, it is this collaborative approach and continual investment in new technology that will shape the future of e-mobility for generations to come. •

The big challenges that e-mobility presents can be met with innovative engineering and collaboration.



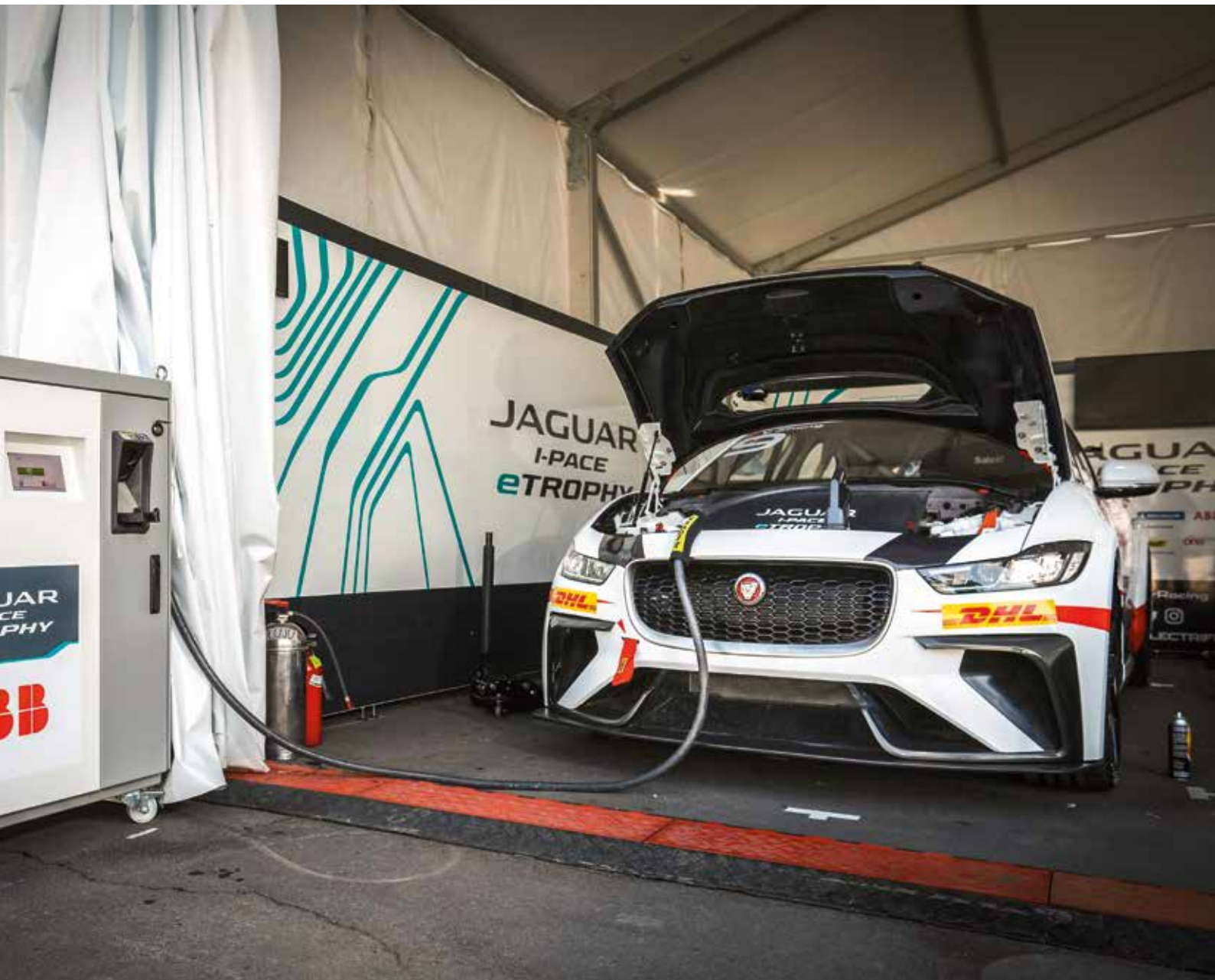

04 ABB's Terra DC charger in action.

05 Jaguar's i-Pace electric racing cars use ABB chargers to quickly recharge their batteries.

References

[1] <https://www.businessgreen.com/bg/news-analysis/3033315/iea-electric-vehicles-to-triple-by-2020-and-soar-to-125-million-by-2030>



05



Productiv



Photo: Tennet



ity



Digitalization provides next-gen tools to make electrical systems more productive and reliable, which means better controls for the underlying industrial processes they enable. It quite literally shines a light not only on what's happening, but what might happen next.

- 46 AI learns to mimic process dynamics
- 52 Unleashing the electrical powertrain through digital monitoring
- 56 Virtual prototyping of sensor systems
- 64 How to plug into asset optimization
- 68 Cosimulation-based circuit-breaker drive development
- 74 Power transformer performance monitoring presented in SCADA



PRODUCTIVITY

AI learns to mimic process dynamics

Industrial automatic control systems employ digital twin models to relate process inputs to outputs. Until recently, it would have needed an extreme engineering effort to provide always-up-to-date digital twins, but recent advances in artificial intelligence technologies are about to change that.

01

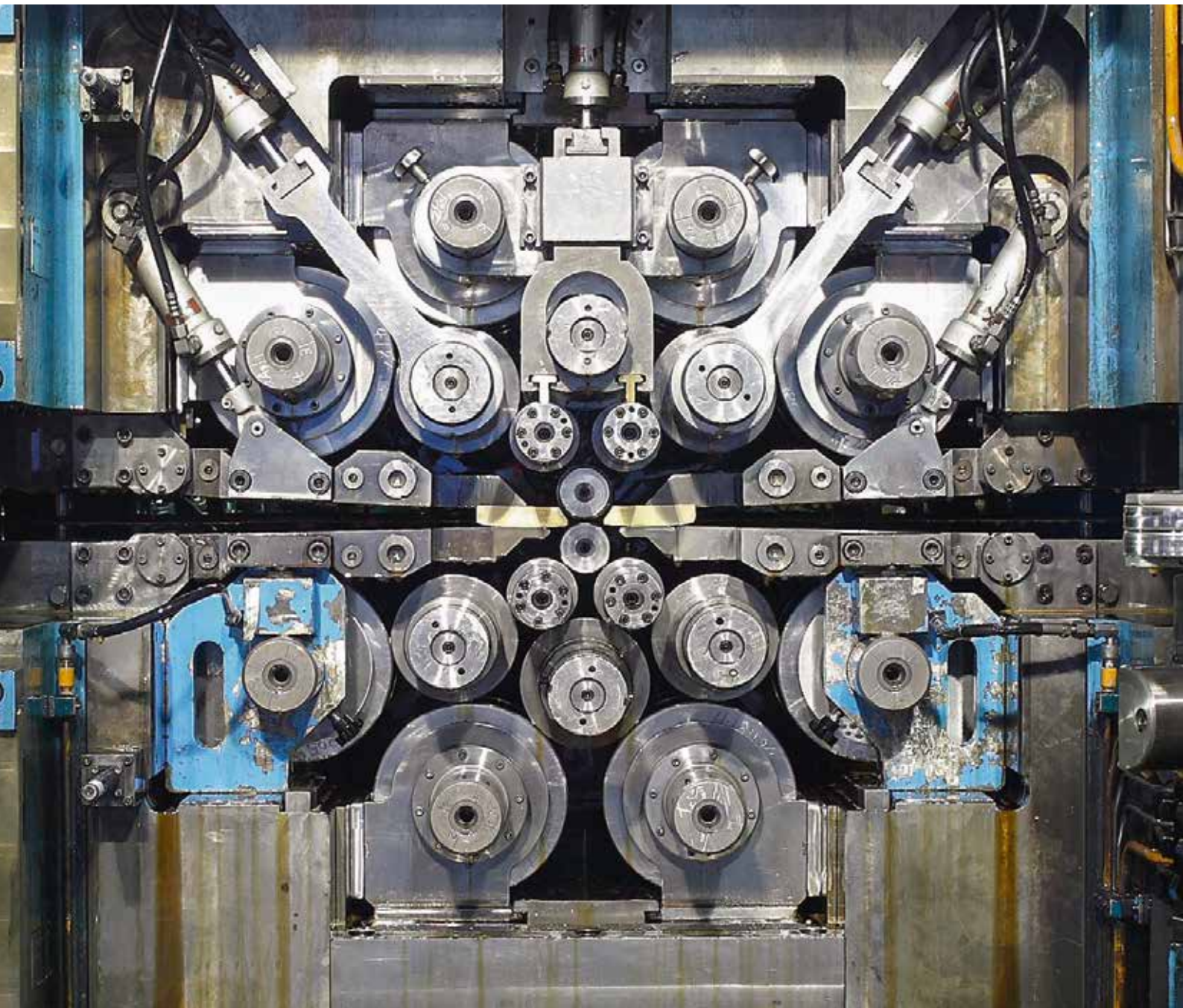

The role of automatic control systems in industrial plants is to maintain a safe and stable operation, ensure product quality by shifting variability from key outputs to process actuators, and provide operational flexibility and efficiency. Digital twins are powerful tools that help achieve these aims.

Practitioners in the domain of process control are no strangers to the concept of digital twins as even the simplest analysis of stability requires a mathematical model, conventionally in the form of a transfer function, to represent the relationship between a system's input and output.

Other automatic control concepts such as controllability and observability also rely on the possibility of model-based analysis. Therefore, the availability of always-up-to-date digital representations of such input-output relationships will be an exhilarating thought for control engineers, especially those dealing with systems whose performance or even configuration is subject to changes and uncertainties. Until recently, this idea would have been a pure fantasy or at best something only possible with extreme engineering effort – but recent advances in artificial intelligence (AI) are about to change that →1.

Digital twin vs. mathematical model

Mathematical modeling approaches in process control can be divided into two main categories: Those that utilize physical insight and domain knowledge, and data-driven methods. However, this division is not necessarily absolute. Most models based on physical relationships contain parametrization options that are chosen based on process data (gray-box models) and for data-driven approaches (black-box models) it is not uncommon to select model orders or forms (such as first-order plus time delay) based on prior experience or domain knowledge.

Regardless of the modeling approach, the conventional practice is to have experienced engineers carry out plant tests or analyze historical data to configure these models for specific applications. These applications can range from the creation of a simple soft sensor (eg, for Kappa number estimation in pulp production), to model predictive control (MPC) – eg, for controlling an integrated gasification and combined cycle plant. Unfortunately, all industrial plants are in a constant state of change: Catalysts in catalytic reactors get poisoned, compressors or turbines experience fouling and heat exchangers clog. Such phenomena lead to deviations from model predictions.

In contrast, a digital twin is a mathematical process model that can stay up-to-date and preferably do so without an army of expert engineers looking at the data to manually tweak and tune the model constituents.

Conventional digital twins: a scalability challenge

In conventional models, future system changes – for example coke deposition on a turbocharger – must be known and modeled in advance. But as system complexity grows, it becomes more and more difficult to write down the relevant mathematical formulas and identify the associated states and parameters to estimate. Qualified and experienced engineers are required to achieve this task and eventually the cost of the solution crosses the commercial feasibility barrier.

The art and science of black-box system identification

“System identification” refers to the model estimation problem for dynamic systems, based on observed input-output behavior [1]. The black-box model identification techniques emerging from this domain of study have found extensive use in industrial applications. Black-box modeling stands out as a scalable alternative to gray-box modeling approaches, especially since it shifts the requirement from domain expertise and know-how to the complexity of the mathematical constructs and algorithms, and to increased amounts of measurement data.

A digital twin is a mathematical process model that can stay up-to-date.

However, some challenges remain. Current practice is to use a series of open-loop and single-variable step tests to generate the data required for model identification using established black-box identification techniques. This procedure is not only time-consuming, but it might also not be feasible if the involved control loops cannot be safely taken into manual operation.

Further, step or impulse-response models can capture some of the output nonlinear dynamic behavior – such as time delays – but they need to be superposed in a linear way to represent multiple-input, multiple-output (MIMO) behavior and can only capture linear input and output relationships in the steady state.

—
01 Recent advances in AI are opening up whole new approaches to automatic process control in industry. Shown is a cluster mill used in metal processing.

—
Mehmet Mercangoez
Andrea Cortinovis
ABB Corporate Research
Baden-Dättwil,
Switzerland

mehmet.mercangoez@ch.abb.com
andrea.cortinovis@ch.abb.com

Luis Dominguez
Former ABB employee

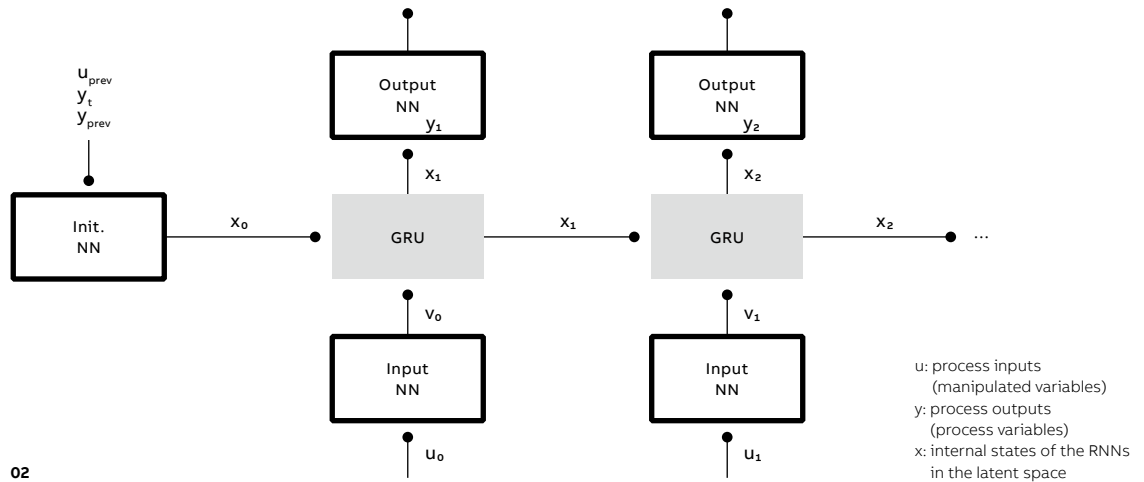

Moreover, these rudimentary models cannot represent open-loop unstable behavior. More advanced methods such as subspace identification can be used to obtain truly MIMO models, but these are inherently linear and cannot efficiently represent delays or saturation conditions. It is possible to utilize multiple models to represent the dynamic system behavior and capture nonlinearities, but this is a nontrivial task requiring further engineering effort.

The AI package: manifold learning meets recurrent neural networks

ABB decided to explore a new approach to constructing digital twins in the process industries, with several main objectives:

- Minimize or eliminate expert intervention or manual engineering.
- Have the ability to build the models without any open-loop plant testing and preferably from historical operating data.
- Retain or exceed previous prediction accuracy levels.

Among these wishes, the one that will run up against fundamental scientific limits is the second one, as no algorithm and computation will be able to extract the information needed if that information is not contained in the data. If a certain operating condition has not been visited by the system, the information needed will be absent and the predictive ability of the derived models will be constrained.

To realize the objectives listed above, recent developments in AI, and more specifically machine learning, were exploited.

The use of neural networks for nonlinear system modeling is not a new idea in process control.

Investigations in the 1990s examined the use of multilayer feedforward networks with hidden layers to approximate plant responses and their derivatives [2]. The conclusions of these early studies mostly highlighted the computational difficulties involved. Also, in those days, feedforward networks were, by design, not optimal for modeling dynamic systems – and key developments in recurrent neural networks (RNNs) or long short-term memory (LSTM) that better represent dynamics had not yet happened. Today, many research articles consider the use of RNNs for modeling dynamic systems in control problems.

Another development – manifold learning – delivered another piece of the solution. Principle component analysis (PCA) and dimensionality reduction techniques, in general, have been frequently used in process systems engineering, especially for condition monitoring and fault-detection applications.

ABB decided to explore a new approach to constructing digital twins in the process industries.

The basic idea here is that the process plants are many-dimensional by nature, but numerous measurements correlate due to their underlying physics. Again, the prevalent methods here were linear and had limited success in capturing nonlinear behavior. Although extensions of the linear methods were proposed and employed with some success, recent developments in artificial neural networks and their use for constructing variational autoencoders (VAEs) has brought a much more significant improvement in the performance

— 02 The basic scheme of the AI algorithm used to predict the future behavior of a process plant given future values of plant inputs.

— 03 Validation results for N-step-ahead predictions in the paper machine case study. Dots indicate measurement updates; uncorrected predictions, where measurements and their histories are updated again, lie between the dots. Y-axes are normalized.

of these approaches. A VAE is an unsupervised learning construct of an encoding and a decoding structure able to map data to a reduced order space and back to the original dimension with the goal of having minimum loss of information in that process.

— The main idea in the ABB approach for creating digital twins is to learn plant dynamics in a low-dimensional space encoded by the VAEs.

The main idea in the ABB approach for creating digital twins is to learn plant dynamics in a low-dimensional space encoded by the VAEs. In practice, the VAEs are realized as feedforward neural networks. In contrast to similar arrangements encountered in the literature, ABB suggests an additional layer that initializes the states of the so-called GRUs (gated recurrent units), which are the main element of the RNNs capturing the system dynamics. Note that the input neural network layers depicted in →2 are only shown



03

for completeness – in typical control problems the inputs are already reduced to a minimum set and are physically independent and uncorrelated. Therefore, a mapping of inputs to a lower dimensional latent space is not needed.

Putting it to the test

To test the performance and robustness of the suggested approach, a complex system concerning the machine direction (MD) control of a paper machine was chosen [3,4]. Paper machines have strong interactions between multiple scanning frames (sensors) and multiple sets of actuators. These interactions affect the properties of the paper produced. Moreover, due to different response times and transport delays between actuators and measurements along the scanned sensor locus, the sheets may experience different shrinkage amounts that lead to different widths. In general, the MD control system should apply control actions that eliminate rapid sheet weight and moisture variations during transitions from manufacturing one type of paper to another (“grade-change”), considering and predicting the long transport delays

The model was validated against plant data that consisted of three inputs: Stock Flow (ST01), Steam Pressure 1 (PR02) and Steam Pressure 2 (PR03); three outputs: Dry Weight (DW), Moisture Content 1 (MT1) and Moisture Content 2 (MT2); and three disturbances: Retention Air flow or Ash Content (RA01), Bright Clay Flow (CY01) and Machine Speed (MS). The objective in the present case study is reference tracking on the three outputs defined above, whereby the disturbances are assumed to be measured. The main challenges of the case study are the system complexity arising from a large number of states, the handling of various delays and the measurement noise added to the output signals.

Training data for this exercise was generated by running a high-fidelity paper machine simulator with various output reference changes and recording the input/output signals. Output reference changes are carried out back-to-back, meaning that no preprocessing is necessary to filter out the steady-state operation. Additive autocorrelated noise is added on each output channel to make the setup more realistic. Independent datasets that were never seen in the training are generated for validation.

The RNN model is constructed in Keras with the backend in Tensorflow. GRU training is based on back-propagation through time (BPTT), which has a relatively high computational cost.

HOW DOES AUTONOMOUS DECISION-MAKING WORK?

Traditional autonomous decision-making system

Traditional autonomous decision-making systems are handcrafted and are based on engineered mathematical models representing the physical reality. As a response to observations or commands, decisions are made by scanning over possible actions and using the mathematical models to determine the outcomes of those actions over a prediction horizon. The algorithm implements the action that produces the best outcome matching the commands.

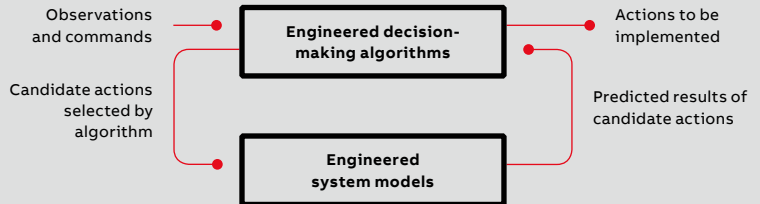

AI-generated model

The modeling method proposed in this article replaces the engineered system models by system models generated by an AI application. These AI-generated models are still compatible with the traditional way of using decision-making algorithms and can be used to generate predictions based on possible actions. They lend themselves to optimization of the actions to obtain the desired behavior and outcomes.

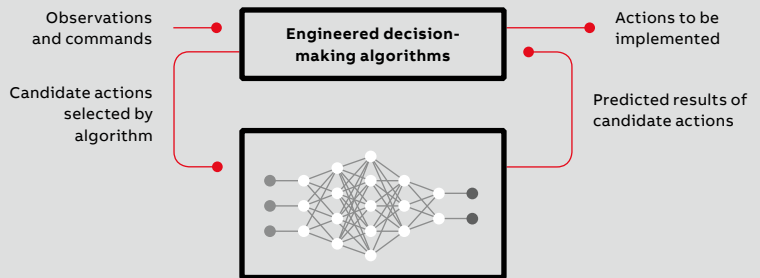

A promising future approach

The two previous schemes rely on the computation of the actions in real time in response to observations and changing commands. The creation of the engineered models or the training of the AI-based models has to happen offline or in a separate step. A promising approach for the future is to also employ AI to learn the best actions corresponding to observations and commands and let the AI decide on the actions directly. The advantage of this approach is the possibility to come up with previously unthought-of strategies that are not restricted by the engineered constructs

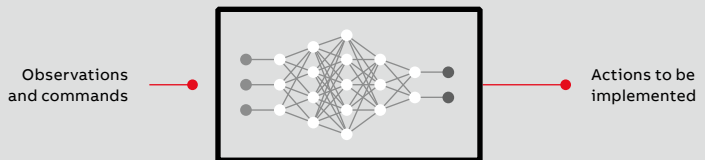

of the past. The proposed learning approach in this article can be used to generate digital twins as playgrounds for such AI algorithms to construct their policies on simulated realities.

04 Autonomous decision making.

05 ABB Ability APCA Suite implementing MD control of a paper machine using the VAE and RNN based modeling approach. The APCA Suite also supports graphical first-principles modeling, linear and nonlinear regression, PCA, artificial neural networks (ANN) and support vector machines (SVM).

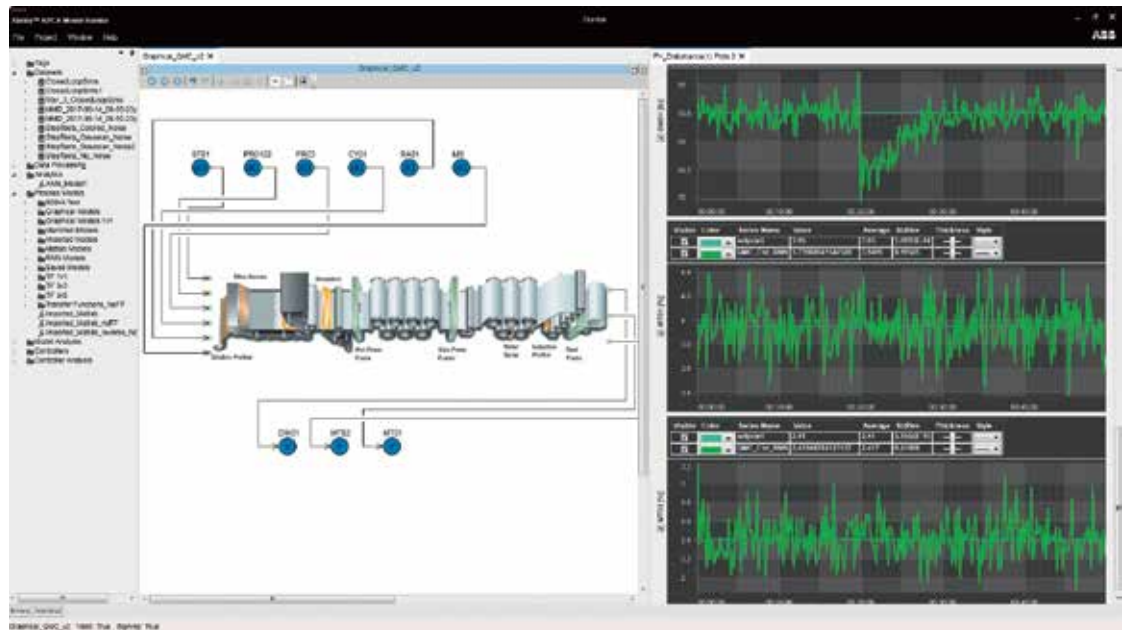

05

References

[1] L. Ljung, "Perspectives on system identification," *Annual Reviews in Control*, 34(1), pp. 1–12, 2010.

[2] K. Hornik, et al., "Universal approximation of an unknown mapping and its derivatives using multilayer feedforward networks," *Neural networks*, 3(5), pp. 551–560, 1990.

[3] S.-C. Chen et al., "Use a Machine's full capability," *Pulp & Paper International (PPI)*, *Process Control*, pp. 39–42, March 2009.

[4] S.-C. Chen et al., "Multivariable CD control applications," *IPW, Process and Quality Control*, pp. 16–20, October 2008.

[5] N. Lanzetti et al., "Recurrent Neural Network based MPC for Process Industries," *European Control Conference*, Naples, Italy, 2019.

[6] L. Dominguez and E. Galleste, "Leveraging advanced process control and analytics in industrial automation," *ABB Review*, 02/2018, pp. 38–45.

Both →3 and the quantitative metrics show that the RNN performs well on the unseen validation set and that it is, therefore, able to learn the dynamics of the system, including its delays. The obtained predictions can then be used for decision support or for closed-loop control using model-based techniques and, in the future, or autonomous operations →4.

Where ABB is now

The present work is just the first step toward the creation of sophisticated digital twins for the process industries. Some ingredients are already established, such as the capability to build accurate nonlinear multivariable dynamic models from closed-loop operating data [5]. The triggers for automatic retraining and the autonomous parameterization of the underlying structures in the associated neural networks are works in progress. The selection of architectures – such as the number of layers in the VAEs or the number of GRUs – is, at the moment, manual and requires knowledge of the deep-learning environments rather than knowledge of the engineering domains. Hyperparameter optimization can address this dependence.

A valuable asset is the ABB Ability™ APCA Suite – a set of tools that simplifies the deployment of advanced controllers and analytic models [6]. With the APCA Suite, analytic models can be deduced from either first principles or process data and deployed in the APCA run-time system. The modeling system described above together with the VAEs and RNNs are now part of the APCA

Suite and are ready to benefit ABB's customers →5. ABB is aiming to further improve these capabilities and offer customers tangible improvements in the safety, availability, quality, efficiency and flexibility of their processes. •

The predictions can be used for decision support or for closed-loop control using model-based techniques and, in the future, for autonomous operations.

PRODUCTIVITY

Unleashing the electrical powertrain through digital monitoring

Electrically driven powertrains are critical components in industry and it is essential that they can run continuously. With ABB Ability™ Condition Monitoring for powertrains, ABB is now helping customers increase the uptime of their entire powertrain. ABB Review interviewed ABB's Sönke Kock to find out more.

AR ABB Review (AR): Sönke, first of all, what is your role in ABB?

SK Sönke Kock (SK): I am ABB's Digital Leader for the Global Business Line Drives. Digital innovation is an important topic in Drives.

AR Let's start at the beginning, shall we: What are electrical powertrains and why are they important?

SK Throughout industry, infrastructure and buildings there is a need to drive conveyor belts, operate pumps, turn mixers, move or process material,

rotate fans, or any one of a thousand other tasks. These tasks are accomplished by electrical powertrains – that is, the connection of a number of drives, motors, bearings and couplings, gears and pumps, in different configurations. These powertrains are critical components for industrial operations, but also for our everyday life. Imagine an elevator not running, the water pressure dropping or the factory conveyor stopping. To avoid these inconveniences, outages, or potentially dangerous situations, it is very desirable to keep a close eye on the condition of the electrical and mechanical equipment.



AR And that is what is done at the moment?

SK Not quite. Traditionally, powertrain monitoring has come at a cost that made it prohibitive to use for anything but the most critical applications. That's because putting in a comprehensive monitoring system requires a sophisticated installation that is sometimes more expensive than the powertrain components themselves! Furthermore, the monitoring equipment and software must be installed and maintained by external specialists. I think you can see the dollars mount up in front of your eyes! For that reason, the industry often reverted to annual or bi-annual vibration measurements as a service, avoiding fixed monitoring equipment installations. This makes condition monitoring much more economical, but now there is a long period between measurements where things can still go wrong. And there is a safety risk, as the maintenance personnel must come close to the rotating machinery.

AR So how is ABB solving this conundrum?

SK With the service ABB Ability Condition Monitoring for powertrains →1.

AR And how does that work?

SK The availability of low-cost, IoT-based – that's the Internet of Things – wireless sensors and data transmission allows for permanent monitoring at a fraction of the cost of traditional condition monitoring systems. ABB Ability Condition Monitoring for powertrains is a cloud service that makes this data permanently available online at minimal installation cost. The solution is based on ABB Ability, which is ABB's unified, cross-industry, digital offering that extends from the device in the field to the edge and all the way to the cloud. ABB Ability enables fast global service, proactive



Sönke Kock
ABB Motion
Ladenburg, Germany

maintenance and a host of other benefits. This means the customer has better insight into their assets, thus enabling a safe, reliable and efficient operation that takes uptime and productivity to new heights.

AR What is contained in the condition monitoring solution?

SK The condition monitoring service currently covers drives, motors, bearings and pumps →2. Condition Monitoring for drives, for instance, is a service that provides real-time information about events in the connected frequency converters. Monitored parameters include the availability of the drives, environmental conditions and faults. With this service, possible problems can be detected early and necessary maintenance measures can be initiated.

AR And I believe smart sensors play a role too?

SK Yes, we can equip motors with the ABB Ability Smart Sensor, which converts traditional motors

—
01 ABB Ability Condition Monitoring for powertrains enables plant operators to improve the performance, reliability and efficiency of their powertrain components.

—
02 ABB connects drives, motors, bearings and pumps for advanced monitoring and analytics.

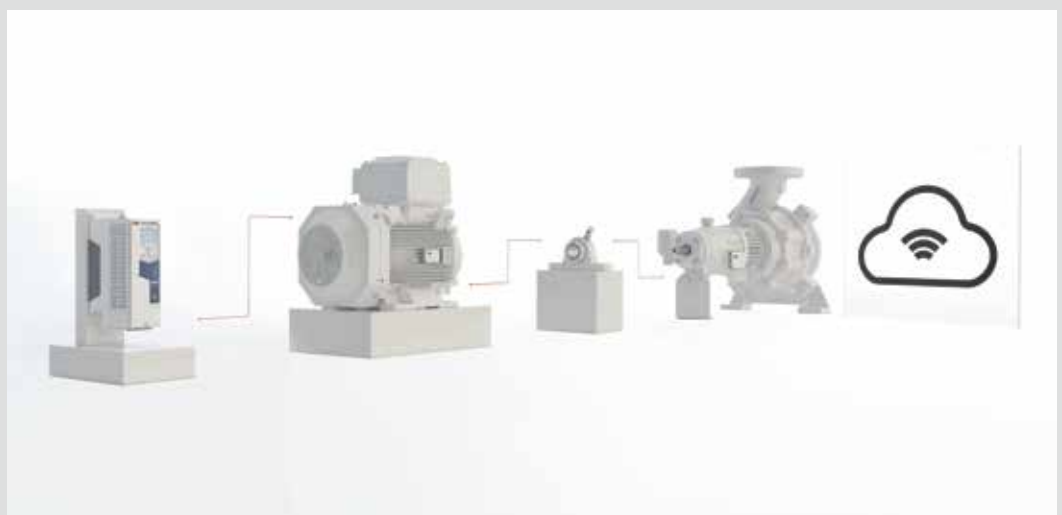



03a



03b

into smart, wirelessly connected devices →3. The smart sensor is attached to, say, low-voltage motors for remote monitoring via an app to the Internet portal. This arrangement creates predictive insights that can increase availability while reducing energy consumption.

AR Are the smart sensors used elsewhere?

SK Yes, in mounted bearings, for instance, to supply status information. Bearings are critical components in the overall system and can be leading indicators of problems, so it is well worth keeping a close watch on them. Analysis of data from smart sensors is also used in pumps to monitor pump temperature, cavitation and bearing condition to prevent clogging or pump malfunction.

AR What other advantages does ABB Ability Condition Monitoring for powertrains give the customer?

SK One very valuable aspect is that the digital powertrain offers users a low-cost introduction to digital monitoring. The low entry threshold lets customers try it and see – and usually they are won over. Other benefits are fast commissioning and installation, as motors, bearings and pumps do not need to be cabled separately. This is a big plus as, if you do get problems during commissioning or operation, the cabling is often the culprit. Ease of use and integration, manufacturer independence, scalability and flexibility are further advantages.

AR Can this solution lead to more comprehensive monitoring?

SK Yes, unlike previous solutions that provided only point data on the state of individual components, there can now be permanent monitoring of all of the components. This comprehensive monitoring delivers benefits such as lower cost, higher uptime and more efficient operation.

AR If it is so comprehensive, does that mean the customer has to install a full-scale monitoring system from the outset?

SK No, not at all! Our solution scales. Any individual component of a powertrain – motor, bearing or pump – can be outfitted with measuring equipment and included in the monitoring system. And then other components can be simply added – just like clickable building blocks! The data is collected in a mobile, easily configurable and scalable cloud-based system that is available through apps and Web portals →4. This all means that a finished solution can be used for only a part of the powertrain – for example, just the motor – or for the entire driveline. Because setup is quick and flexible, the customer can try out various configurations and invest in the condition monitoring solution that best fits their needs.

AR Are companies already using ABB Ability Condition Monitoring for powertrains?

SK Companies around the world are indeed already using it for optimized monitoring of their equipment. For example, the Swedish utility Uppsala Vatten och Avfall employs it to provide its operators with reports on real-time indicators for their pumping systems, such as reliability, usage, power consumption and load. Norway's Glencore Nikkelverk uses it in a seawater pumping system that distributes cooling water around their plant. The integration of the ABB solution gives the mining company the opportunity to gather more information about the thermal condition of the drives and to compare the data with that of other monitoring solutions.

AR Are there other examples?

SK Yes. All around the world. The giant SSAB steel mill in Finland uses ABB Ability Remote Assistance, a service-ready offering that comes along with the ABB Ability Digital Powertrain offering, to increase the reliability of key drives in their coking plant. The remote monitoring system has already enabled faster fault detection in a variable-speed drive on site. Further afield, global agricultural company Olam International has installed the ABB Ability Smart Sensor for motors in several factories: a cocoa plant in Singapore, a dairy in Malaysia and a sugar factory in Indonesia.

—
03 The ABB Ability Smart Sensor.

03a The Smart Sensor converts traditional motors into smart, wirelessly connected devices and enables an early warning of potential problems. Here it is seen on a mounted bearing.

03b Fitting and removal of the Smart Sensor is uncomplicated.

—
04 Portal pad. A monitoring portal shows key operational parameters of individual assets as one unified system.

—
05 The agricultural company Olam International is reducing motor downtime with Smart Sensors from ABB. Here, the Smart Sensor is mounted on a motor in an Olam facility.



04



05

The sensors allow remote monitoring of the motors and, thus, predictive maintenance →5. Downtimes have been significantly reduced and the life of the system has been extended. The customer is very happy and has told us that the ABB digital remote monitoring approach is much better than the previous method as shutdowns can be avoided and overall reliability increased.

Another significant example is found in the world's biggest free-fall simulator – Aero Gravity – in Italy. To meet the highest safety standards, Aero Gravity uses the cloud-based ABB Ability Condition Monitoring service for its drives. The service continuously collects data on key drive parameters and provides an overview through an indication system to identify areas that may need extra attention. Technicians can diagnose and analyze potential problems through an advanced set of online tools.

AR How about training personnel to use the system. Is it easy to operate?

SK A particular advantage of the powertrain analysis is the fact that all components report their status data in the dashboard of the user portal via an intuitive traffic light display. Green means that the component is OK; yellow indicates that the user should keep watching the component; and red indicates that there is a significant problem. Maintenance technicians and operators can thus maintain an overview of the powertrains. Of course, they then have easy access to any in-depth data they might need to review, such as vibrations, speeds, temperatures or power consumption.

AR Is there more to the digital powertrain than intelligent maintenance?

SK Absolutely. Imagine you are the manager of a major pump station. The total transparency of the operating point and the stress on all the components of your pumping systems allows you to select operating points for your different pumps that maximize their lifetime and minimize the energy consumption of your installation. So it is not only about predictive failures, it is also about intelligent and sustainable operation.

AR What are the next steps?

SK We launched the ABB Ability Digital Powertrain at the 2019 Hannover fair and have been busy with the work a major product launch entails. However, we already have expansions and enhancements in the pipeline. Maybe you'll have me back in the near future to describe them!

AR Sönke, thank you for the interview. •

PRODUCTIVITY

Virtual prototyping of sensor systems

Virtual prototyping of systems that contain a mix of sensor technologies optimizes the design pathway and reduces product time-to-market. Examples from high-voltage measurement, arc-fault detection and electronic overload protection illustrate the many advantages of this cosimulation-based approach.

—
01 Modern industrial plants can feature systems in which a large number of different sensor technologies have to work together. Virtual prototyping of such systems makes product development faster and delivers designs that are less error-prone and more accurate.

Modern industrial systems often feature many heterogeneous components that operate in different modalities (software, optical, electrical, thermal, or mechanical) and on different timescales. The optimal design of such systems calls for methodologies that allow for cosimulation of the interaction of these components without the need to build physical prototypes. Such approaches are often termed “virtual prototyping” or “system simulation” →1.

—
One of the main goals of virtual prototyping is to reduce the number of physical prototypes needed to develop new technology.

The simulation approach described here is sometimes referred to as “network simulation.” In this approach, the interaction of design units is simulated according to a predefined set of rules – rather like Kirchhoff’s laws in electrical systems. This method stands in contrast to finite-element simulation where all minute elements of a problem are simulated.

—
Yannick Maret
Matija Varga
Stefano Marano
ABB Corporate Research
Baden-Dättwil,
Switzerland

yannick.maret@ch.abb.com
matija.varga@ch.abb.com
stefano.marano@ch.abb.com

Francisco Mendoza
ABB Corporate Research
Ladenburg, Germany

francisco.mendoza@de.abb.com

Joris Pascal
Former ABB employee





One of the main goals of virtual prototyping is to reduce the number of physical prototypes needed to develop new technology and thus decrease time-to-market →2.

Motivation for virtual prototyping

The growth of heterogeneous components in industrial sensor systems is well illustrated by the changes going on in high-voltage measurement systems. Here, for example, conventional instrument transformers (ITs) are steadily being replaced by nonconventional instrument transformers (NCITs).

Conventional ITs are current or voltage transformers that enable accurate measurements in the electrical grid. However, as the power carried by the grid increases, the magnetization of an

IT's iron core will begin to saturate and thus limit dynamic range. A conventional IT also suffers from: overheating effects due to eddy currents; sluggish transient behavior that slows its response to critical events such as short circuit or overvoltage events; and risk of fire, explosion or leakage should the IT be paper- or oil-filled. Further limitations of conventional IT technologies are size, weight and cost. NCITs solve these limitations by using alternative sensing principles, eg, electro-optical, air-core coils, etc.

The development of a new NCIT requires knowledge of physics (eg, optical components, mechanical parts), electronics (eg, signal conditioning, communications) and mathematics (signal processing).

—
Virtual prototyping enables a new design methodology that encompasses the entirety of a complex system.

This multidisciplinary interdependency stems from the NCIT architecture, where the constituent elements no longer have a simple passive connection but have to interact in a closed loop.

Virtual prototyping enables a new design methodology that encompasses the entirety of a complex system. The resulting virtual prototype allows the development team to efficiently verify, test and improve the design as a whole rather than as separate units.

Benefits of virtual prototyping for sensor system development

Virtual prototyping helps to partition a design in an optimal and objective way. In other words, the design team is aided in their decisions as to which tasks should be implemented in hardware, which in software and, similarly, if signals should be processed in an analog or digital manner.

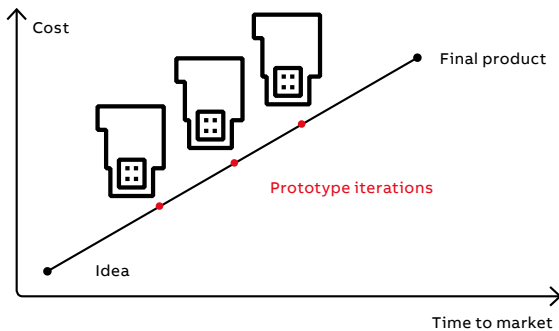

02a

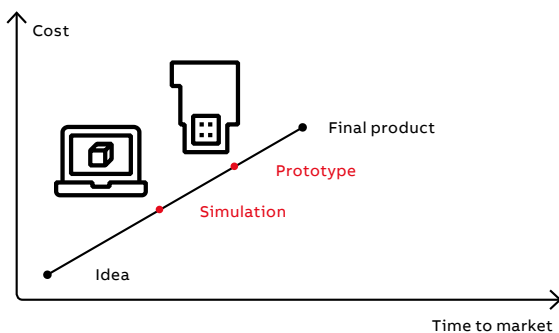

02b

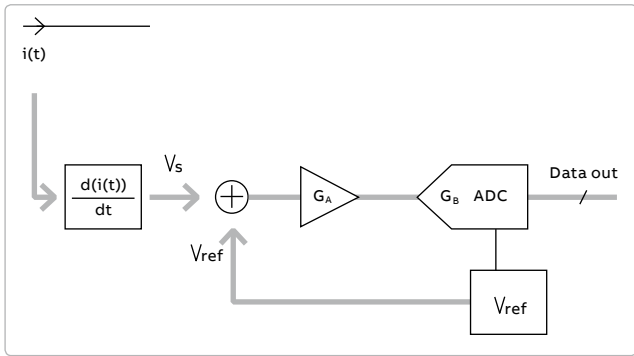

Fully behavioral
VHDL-AMS

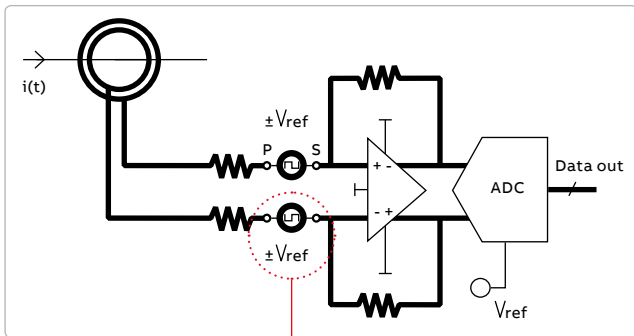
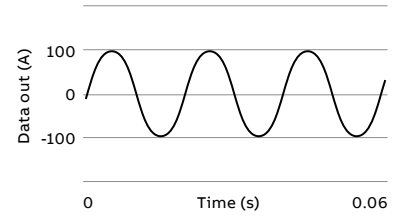

Sensor: physical
model
ADC, amplifier:
behavioral
Switches: structural
VHDL-AMS

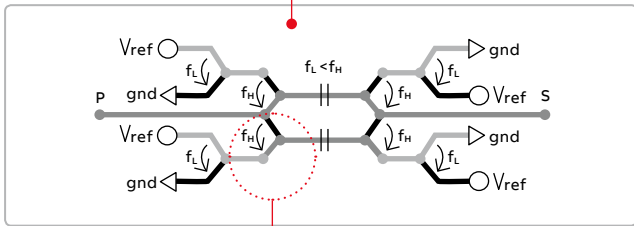
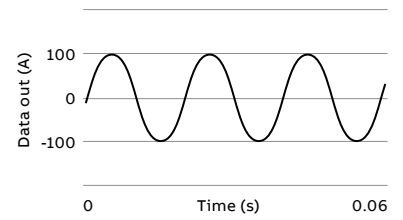

Switches:
IC manufacturer
Spice model
VHDL-AMS/Spice

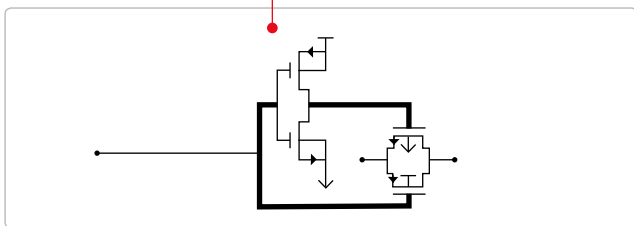
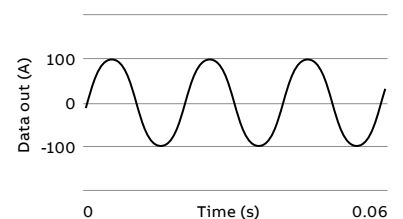

Transistor
model
VHDL-AMS

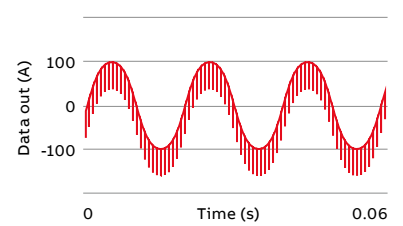

Abstraction level

03

02 Virtual prototyping radically reduces cost, time-to-market and the number of physical prototype iterations needed.

02a Traditional approach.

02b Using virtual prototyping.

03 Different levels of detail for a self-calibrating frontend for an NCIT based on a Rogowski coil.

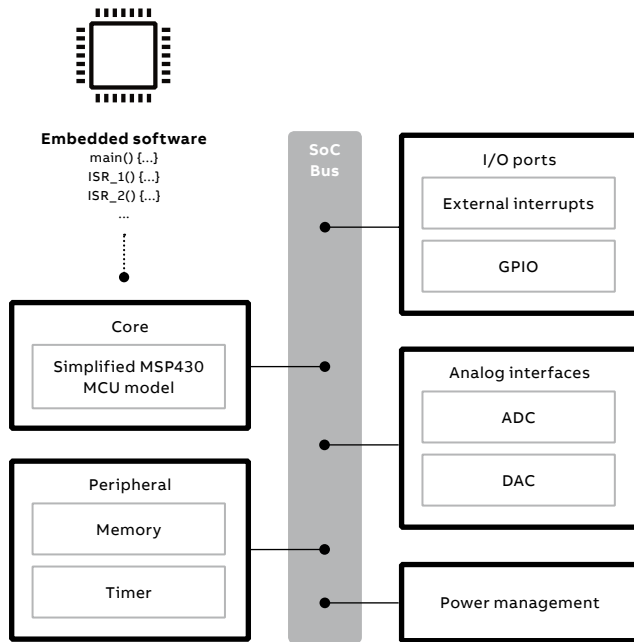

04

Besides partitioning, virtual prototyping also assists in correctly assigning system specifications to individual modules by allowing error propagation between modules and overall sensor system accuracy to be studied. Design errors will also be detected more easily and sooner than with traditional prototyping. Furthermore, the impact on the full system of a design change – for example, a cost-optimization measure – in a single module can be quickly evaluated.

Virtual prototyping accelerates future development projects too, via model reuse. Ideally, developed components should be organized in libraries that are retrievable by future designers or automatic design tools.

Another application of virtual prototyping is the collaboration between different product families. For example, a current sensor model can be reused in a circuit-breaker virtual prototype, which will be further reused for customer application modeling.

Regarding the customer applications, virtual prototyping enables an understanding of customer needs that goes far beyond the simple fulfillment of the requirements given in the standards – for

example, when customers regularly exceed sensor system specifications. By introducing these new use conditions into the virtual prototype, ABB can understand the impact of such misuse – and quantify it and inform the customer accordingly. Such specific requirements can be taken into account in the next sensor development.

Virtual prototyping: methodology

Several virtual prototyping methodologies exist. For sensor development, one tool used by ABB is based on VHDL-AMS Hardware Description Language (standard IEEE 1076). The AMS extension of VHDL stands for “analog and mixed signals.” As the name suggests, AMS supports the modeling of analog and mixed-signal entities and is operated on simulators that handle signals with both continuous and discrete time information. The simulator is event-driven, which means that only a change of signal value triggers the computation of a new operating point. This technique is highly efficient in terms of simulation time for combined analog and digital signal simulations. In addition, ABB employs SystemC, a library class (standard IEEE 1666) based on C++ for the modeling and simulation of digital hardware and software components in embedded systems. In order to build virtual prototypes that take digital hardware and software components into account, SystemC and VHDL-AMS models are cosimulated.

—
Virtual prototyping accelerates future development projects too, via model reuse.

The use of VHDL-AMS facilitates top-down or bottom-up design techniques and even the combination of the two. This flexibility allows a project team to start part of a design with high-level models and steadily to refine the model’s level of detail as the project develops. This is a top-down approach.

In parallel, if part of the project team already has some detailed models of other components, these either can be used as they are or can be simplified to a higher modeling level to shorten the simulation time. This is a bottom-up approach.

—
04 Microcontroller simulation model in SystemC.

—
05 A real home electrical installation was abstracted with a model comprising cables, loads and an arc-fault. By varying the parameters of the model, a rich dataset of current and voltage signals can be generated. Reproducing the same setups with real measurements would be very costly and time-consuming, if even possible.

05a Simulated arc voltage.

05b Simulated arc current.

VHDL-AMS has inbuilt support for multiple component descriptions and hence supports multiple levels of abstraction for a given model. →3 shows different levels of detail for a self-calibrating frontend for an NCIT based on a Rogowski coil. The self-calibration is achieved by injecting a high-frequency square signal with a very stable amplitude into the electronics. The software then computes calibration coefficients and uses them to correct the measured low-frequency signal. The self-calibration principle was first proven via simulation using a high level of abstraction. The first prototype functioned correctly but exhibited high-frequency noise in the measured signal. This phenomenon could be reproduced in simulation by increasing the level of detail of the transistors in the analog switches used for the square signal generation. ABB subsequently used the virtual prototype to identify and validate appropriate countermeasures (namely, analog filtering).

—
Project teams are able to start part of a design with high-level models and steadily to refine the model's level of detail as the project develops.

SystemC is used to create simulation models of digital components such as microcontrollers, analog-digital converters, storage units, transceivers, etc. →4. The high level of abstraction to which models are described makes it possible to create and reuse components with considerably less effort than with hardware description languages such as VHDL. Such components are put together to create virtual prototypes that mimic the behavior of real hardware platforms and that can

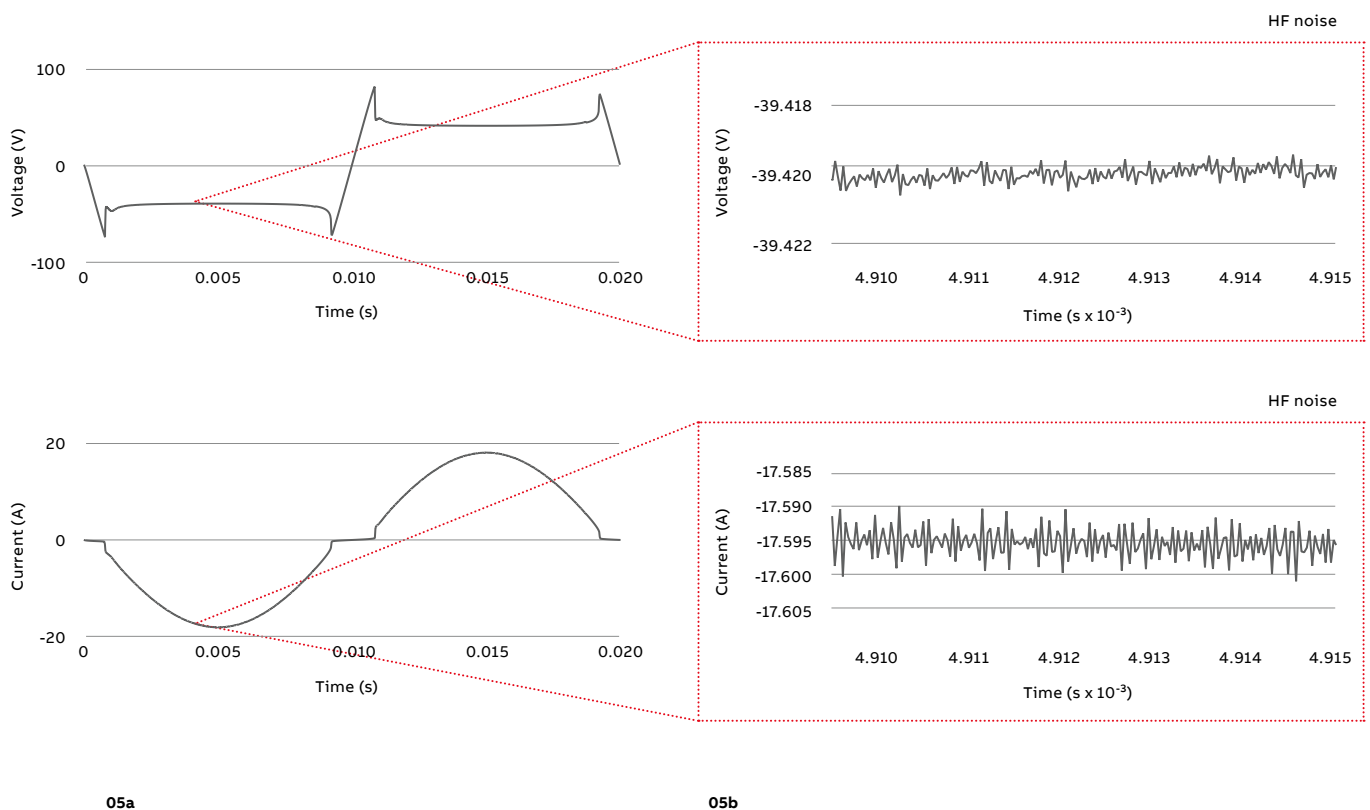

execute native software applications. This makes it possible for software developers to start coding and debugging long before hardware prototypes are available.

A virtual prototype of the system can be devised as soon as high-level models of all key components are available. This should ideally occur early on in a project as it gives a clear overview of the product under development and supports idea generation and key architectural decisions.

Arc-fault detection device simulation

Electric arc faults in home installations pose a fire risk. An arc-fault detection device (AFDD) – consisting of an electromechanical breaker, sensors and a microcontroller – interrupts the electrical circuit upon detection of an arcing event and thereby reduces fire risk. AFDDs distinguish hazardous arcing from signals produced by household appliances (eg, drills, pumps, powerline

communications) – though avoiding false trips caused by certain low-quality home appliances can be a challenge.

To simulate the different current and voltage signals that an AFDD can experience during normal or abnormal operation, ABB devised a VHDL-AMS model of a domestic electrical installation consisting of cables, different load types and an arc fault. Various electrical topologies, load types and fault locations were set via parameters →5.

It is possible for software developers to start coding and debugging long before hardware prototypes are available.

The high-level model of the sensing section used a measured transfer function approximated as a rational Laplace expression. The microcontroller arc-fault detection algorithm is abstracted as a Matlab script for use in the simulation.

Combining the virtual prototype of the AFDD with that of the household appliance facilitates different test scenarios and tracking of AFDD status over time while exploring details of why a trip did or did not occur. The level of detail and customization of this virtual testbed will allow new sensing principles, electronics and algorithms to be explored, and new standard requirements to be assessed, without the need for a physical prototype or laboratory experiments. Once a principle has been tested successfully with the virtual prototype, final validations are performed on a physical prototype.

Electronic overload (EOL) relay simulation

An EOL relay uses a current transformer to measure the current in a motor. Current overloads will, after a certain time, trip a relay. EOL relays thus offer reliable and precise motor protection in the event of overload or phase failure.

An initial EOL virtual prototype containing digital components similar to →4 was used to perform software-in-the-loop tests. This helped to validate the functionality of a newly developed sensing algorithm. The simulation time for each test case was only a couple of minutes, which facilitated iterative adaption and improvement of the sensing algorithm.



06a



06b

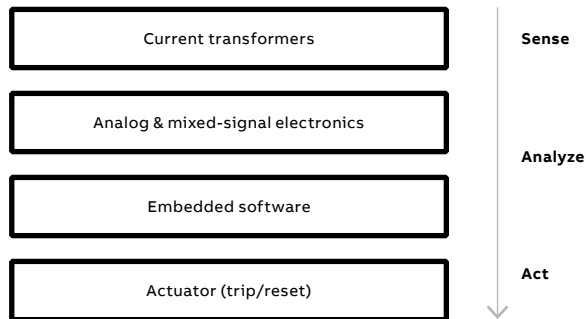

06c

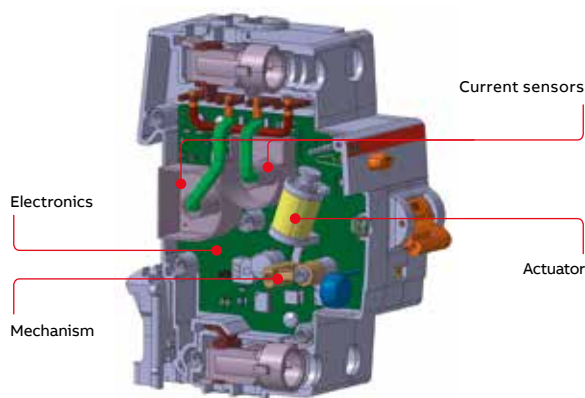

06d

As modeling tools improve, and libraries become more extensive and more detailed, virtual prototyping will reproduce real-life device behavior even more closely and will thus find use in many other product areas. This evolution will be driven by the ever-shorter product life cycles that are evident in almost every area of modern industrial technology and the faster development and productization times these require. •

Simulation results provided valuable insights and helped identify and solve design flaws earlier.

Acknowledgments

The setup of the methodology described here and some results were achieved with the collaboration of Professor Jürgen Becker, FZI (Forschungszentrum Informatik), Karlsruhe Institute of Technology; Dr. Alain Vachoux and Juan Sebastián Rodríguez Estupiñán, EPFL (Ecole Polytechnique Fédérale de Lausanne); and Dr. Jean-Baptiste Kammerer and Simon Paulus, UNISTRA (University of Strasbourg).

06 Arc-fault detection devices and EOL relays are two ABB products whose design encompasses many domains.

06a Arc-fault detection device.

06b EOL relay.

06c Range of domains in arc-fault detection devices and EOL relays.

06d The interior of the arc-fault detection device shows the different domains.

In a later development phase, a more complete virtual prototype was used to test the full measurement chain of the device. This more sophisticated method required simulation of current transformers, analog electronics, digital electronics and embedded software subsystems →6. Monte Carlo simulations were then used to understand the effects that typical component deviations (eg, in resistors, capacitors, regulator output voltages, op-amp offset voltages, etc.) have on the EOL relay trip-time calculation accuracy. Simulation results provided valuable insights and helped identify and solve design flaws earlier than would normally be the case. Tests at various operation points and temperatures can now be performed in a couple of hours, thereby saving days of testing in the laboratory.

PRODUCTIVITY

How to plug into asset optimization

A recent ARC Advisory Group market study declared ABB to be the world's No.1 Enterprise Asset Management (EAM) software provider to power generation, transmission and distribution utilities.



Matt Zafuto
Enterprise Software
Grid Automation
Broomfield, CO, USA
matthew.zafuto@us.abb.com



John Finney
Grid Automation
Zurich, Switzerland
john.finney@ch.abb.com

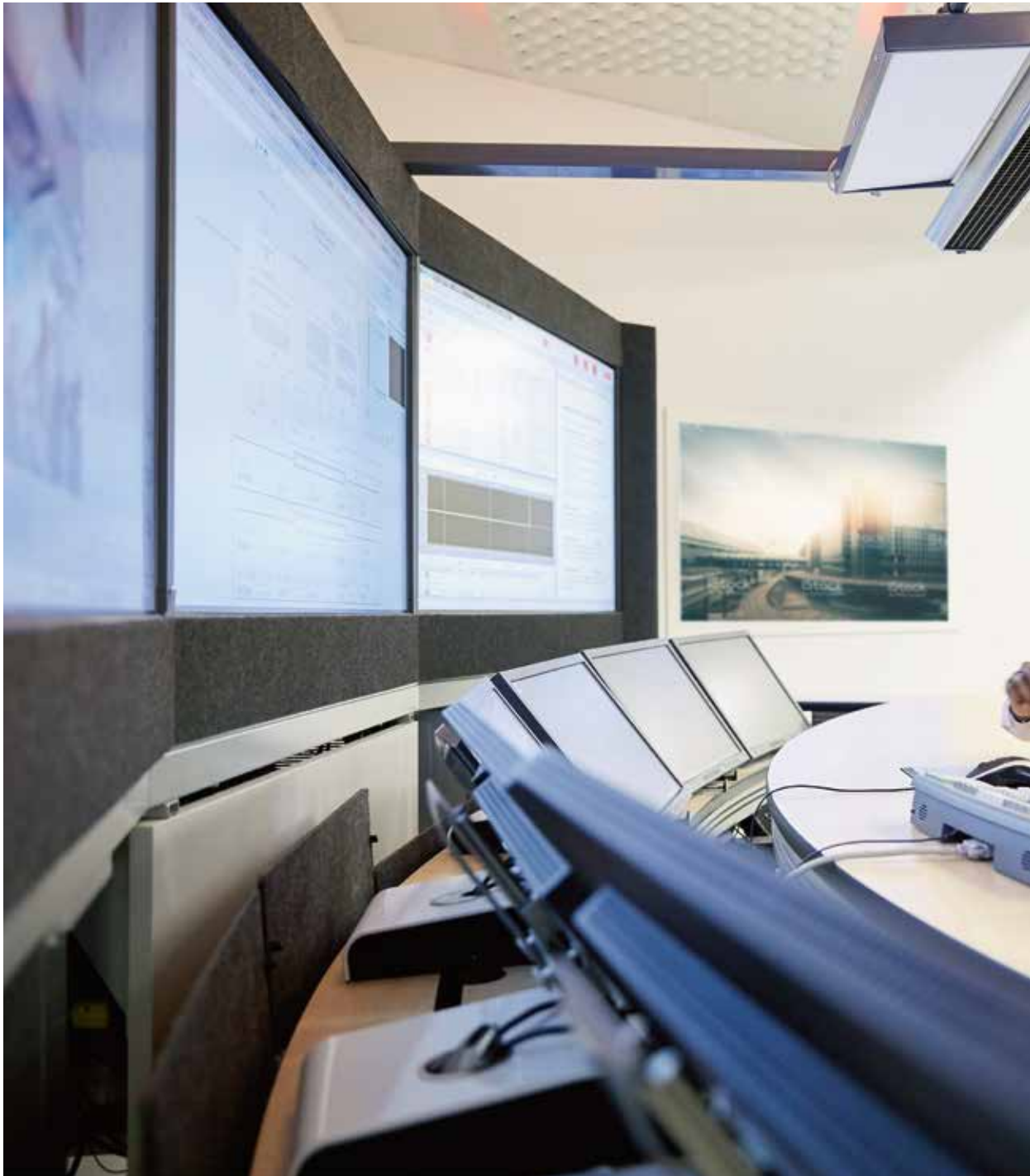

Driven by the growing power of machine learning, ABB's new Ability™ Ellipse® software is increasingly unifying the functionality of the company's world-class solutions for Enterprise Asset Management (EAM), Workforce Management (WFM) and Asset Performance Management (APM). As this process unfolds, the solution is poised to revolutionize predictive and preventive maintenance.



Grid complexity is growing by leaps and bounds. This can be seen in today's smart meters and switches and in distributed energy sources such as solar and wind: In the future there will be a corresponding increase in electric vehicles and buildings that are not only energy customers, but energy storage systems and even energy producers.

Coupled with this growth in complexity is a massive increase of available data. This presents both challenges and opportunities. The challenge is that it is clear that traditional asset management approaches will not be enough.

—
Utilities can now use a single, streamlined solution for the management, maintenance and monitoring of assets.

The opportunity is that by using data effectively a more accurate and holistic digital view of the real world can be created, that will allow challenges to be met through digitization and automation.

Against this backdrop, ABB has announced the global launch of its Ability™ Ellipse® software, a comprehensive solution that will enable electric power utilities to optimize asset utilization, drive down maintenance costs and reduce equipment failures and system outages.

“We understand the challenges electric utilities face in driving greater levels of performance in an increasingly complex grid,” says Massimo Danieli, head of ABB's Grid Automation business. “With ABB Ability Ellipse, utilities can now use a single, streamlined solution for the management, maintenance and monitoring of assets, enabling a stronger, smarter and greener grid.”

Leveraging the power of machine learning

Driving these capabilities is the growing implementation of machine learning, which is quietly starting to revolutionize asset performance management assessment and risk-based asset management capabilities. Leveraging the enormous volumes of data generated by online sensors, the vastly improved communications capabilities made possible by the Internet of Things (IoT) and the power of Microsoft’s Azure technology, machine learning algorithms stand ready to ingest this data, learn, generalize and make inferences with limited – or no – human intervention. These packaged machine learning models are now available in the ABB Ability Ellipse platform, which provides asset-intensive industries with solutions for maintenance prioritization and asset renewal.

Packaged machine learning models are now available in the ABB Ability™ Ellipse® platform.

Given the holistic nature of the information gleaned by machine learning systems, new opportunities for breaking down barriers between domain-specific silos and streamlining operations and strategies are opening up. “The biggest risk utilities face on the journey to digital transformation is the inability to unify applications and

data,” says Kevin Prouty, Vice President IDC Energy Insights. “One of the most obvious starting points for utilities is to address the silo approach to asset management and workforce management in their organizations. As asset performance management becomes a focal point for transforming the modern grid, it is vitally important that utilities manage their assets and labor with a cohesive strategy.”

And that is what the ABB Ability Ellipse solution is helping customers achieve. ABB has 1.3 million assets that are in production environments and are analyzed in customer environments every day. In one real-world test scenario with an existing customer, for instance, the Ellipse machine learning algorithm was able to predict the imminent failure of large power transformers based on (electrical) partial discharge data with sufficient lead time to prevent catastrophic failure. Up to now, failure prediction for transformers has been hit or miss. This scenario represents one of several examples where the electric utility industry has been able to capture real-life transformer failures in progress and where it’s been possible to address the issue before it could cause a power outage.

In another interesting pilot application, machine learning was successfully applied to the asset performance management assessment of point switches and motors, which enable trains to successfully navigate rail systems. The rail transportation industry is actively seeking to improve prediction of asset deterioration, since today’s alarms tend to be generated only during a failure or after a failure occurs. Supported by machine learning, advanced pattern recognition techniques can now enable the identification of assets operating outside “normal” conditions, thus providing early warning to operators for asset-specific maintenance.

As both of these cases illustrate, the potential benefits of machine learning-based asset performance predictions include vast potential improvements in terms of safety, costs, performance management and risk mitigation.

Number one

In view of ABB’s powerful role in these key areas, a recent ARC Advisory Group market study declared ABB to be the world’s No.1 Enterprise Asset Management (EAM) software provider to power generation, transmission and distribution utilities. The ARC Advisory Group is a leading technology research and advisory firm for industry, infrastructure and cities. The findings were part of ARC’s

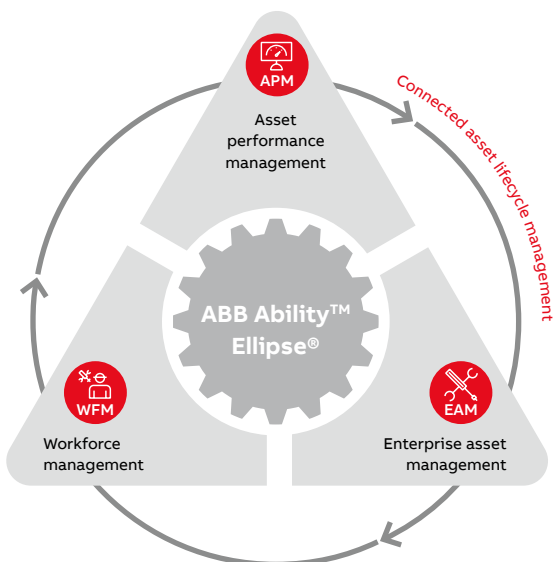

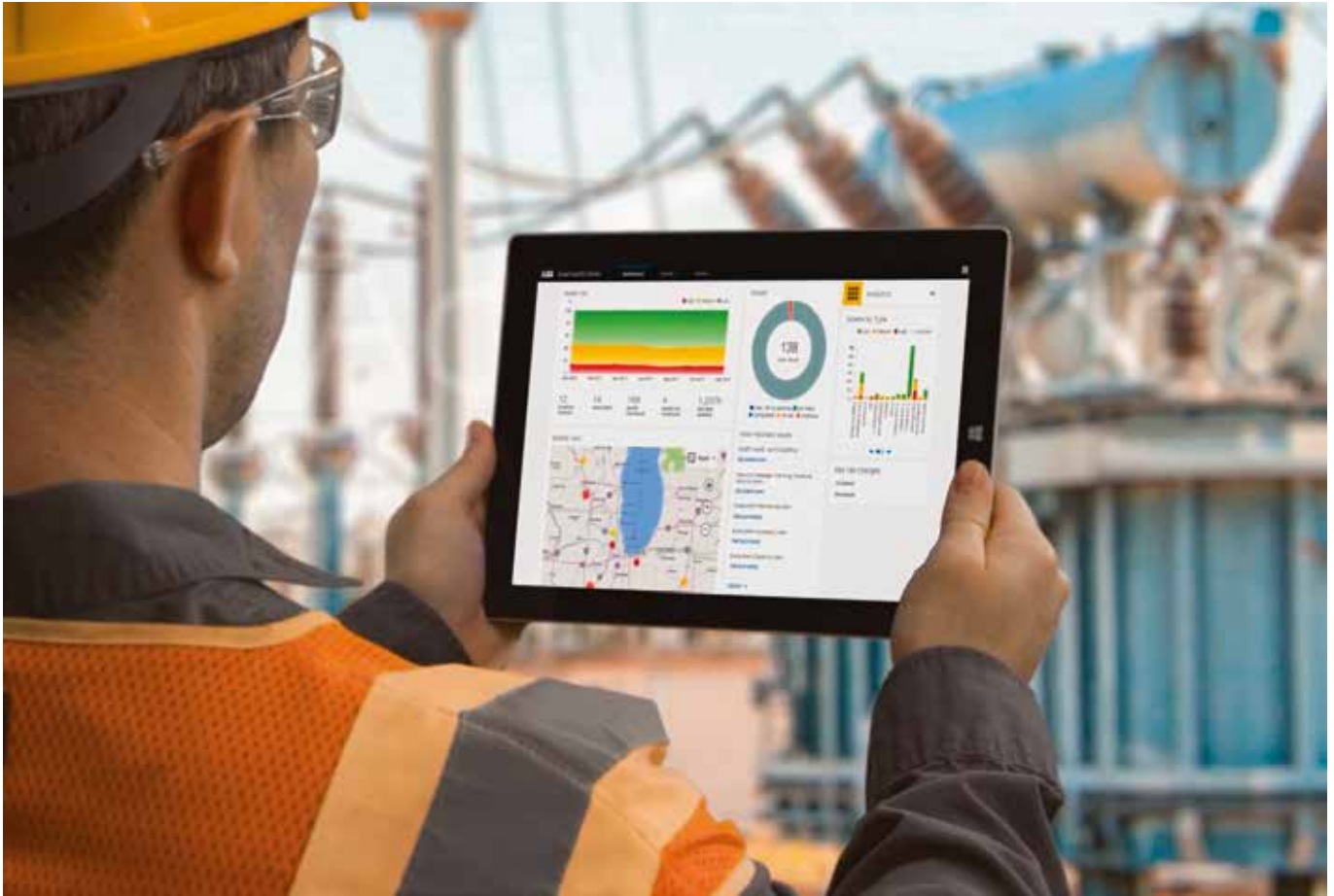

02

— 01 With ABB Ability Ellipse, utilities can now use a single, streamlined solution for the management, maintenance and monitoring of assets, enabling a stronger, smarter and greener grid.

— 02 ABB Ability Ellipse connects predictive analytics and asset management systems to the mobile worker in the field. It is available either as an “on-premises” or “software-as-a-service” solution for electric utilities and other asset-intensive sectors such as renewables, transport and mining.

comprehensive market and technology study titled “Enterprise Asset Management Global Market Analysis 2017-2022.”

ARC’s study also named ABB as the world’s leading EAM provider for linear assets such as power lines, substations and towers; the global leader in EAM for the mining industry, and the number one supplier of both EAM and field service management software in Asia.

“ABB’s Power Grids business is at the forefront of digital solutions in energy,” said Ralph Rio, Vice President, ARC Advisory Group. “ABB moved to the top of ARC Advisory’s EAM leaderboard in 2018 in electric power generation, transmission and distribution due to its deep domain expertise and track record with utilities around the world,” he said, adding that: “Our research revealed the global EAM market grew an impressive 11 percent in 2017. ARC Advisory expects this high growth to continue, which bodes especially well for ABB since power is the world’s largest EAM market.”

— The ABB Ability Ellipse solution is poised to revolutionize predictive and preventive maintenance.

All in all, by unifying the functionality of ABB’s world-class solutions for Enterprise Asset Management (EAM), Workforce Management (WFM) and Asset Performance Management (APM), the ABB Ability Ellipse solution is poised to revolutionize predictive and preventive maintenance. “ABB Ability™ asset and workforce management solutions are uniquely suited to the needs of the electric power industry,” says ABB’s Danieli, “Our continued EAM market leadership reinforces ABB’s position as a partner of choice.” •

PRODUCTIVITY

Cosimulation-based circuit-breaker drive development

The development of next-generation circuit-breaker drives requires an understanding of mechanical, electrical and magnetic phenomena and their interplay. Cosimulation of these domains leads to speedier development and better drives.

—
Thorsten Schindler
Arda Tüysüz
Christian Simonidis
 ABB Corporate Research
 Ladenburg, Germany

thorsten.schindler@
 de.abb.com
 arda.tueysuez@
 de.abb.com
 christian.simonidis@
 de.abb.com

Climate change concerns, along with increasing energy demand, are fueling a rapid expansion in generation from renewable energy sources. In fact, wind and solar are the fastest-growing electrical energy sources in the world today. However, the very nature of these energy sources presents challenges for the transmission and distribution grids that they connect to [1] →1. The interruptive nature of, for example, wind and solar energy penetration, obliges transmission and distribution system operators to look for ready solutions and new middle- and long-term strategies.

—
ABB's VM1 MV circuit breaker is maintenance-free and can be employed in a wide range of applications.

TenneT in Germany, for example, even today regularly points out the tremendous rise in the number of emergency interventions needed to stabilize the grid [2]. The causes of these interventions are the

time-varying energy demand in the south of Germany and, more importantly, the highly stochastic wind energy production in the north of the country and the slow rate of installation of appropriate north-south links.

Qualitative challenges – like the accommodation of more (capacitive) and synchronous switching due to the introduction of more compensation systems, faster and more reliable switching, adaptive travel-curve shaping and recognition – may be faced by electromagnetically driven switchgear. Compared with traditional equipment, such switchgear has fewer parts, simpler mechanical sequences, extremely high reliability and overall quality, very long lifetime and universality of use. For example, ABB's VM1 medium-voltage (MV) circuit breaker is maintenance-free and can be employed in a wide range of applications: from power stations through controlled distribution in transformer substations to multiple uses by the chemical, steel and automobile industries as well as for power supplies in airports, buildings and the like [3].

—
01 The increasing number of renewable energy sources connecting to the grid places great demands on equipment, especially switchgear, such as circuit breakers. Cosimulation of breaker mechanics, electrics and magnetics leads to better breaker designs.





02

→2,3 shows the arrangement of the VM1 circuit breaker, which consists of a linear electromagnetic actuator, an electronic controller, a capacitor as an intermittent energy source, a main shaft connected to the three vacuum interrupter (VI) poles and several sensors for switch position detection. The overall system has three main parts: the three poles, the linkage to the actuator and the linear magnetic actuator. With the opening and closing coils, opening, closing, latching and releasing can be handled with a single actuator.

The transient nature of the electromagnetic actuator physics means the mechanics and the electromagnetics of the system need to be studied.

For the closing operation, the actuator needs to provide linear motion to the pushrod within 45 to 60 ms. The counterforce seen by the actuator is the sum of the forces for compressing the contact springs, as well as the inertial forces, projected on

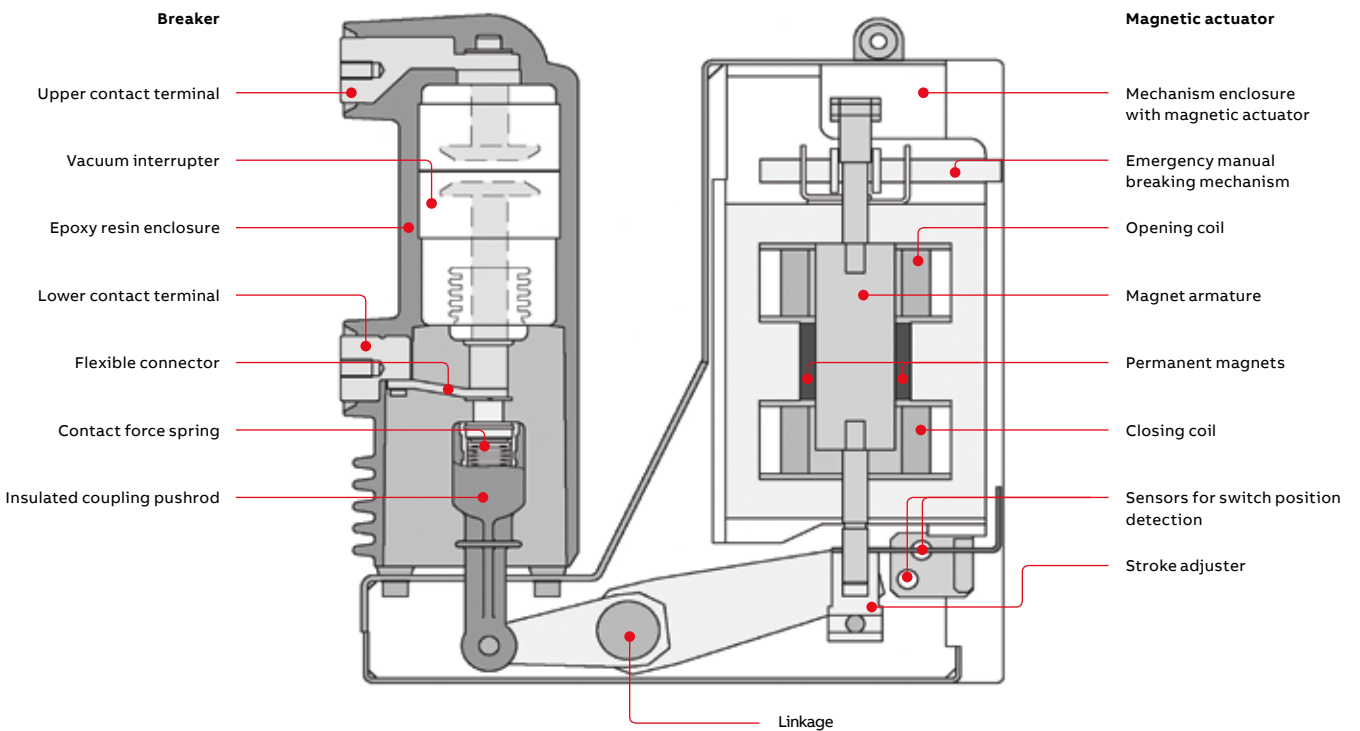

03

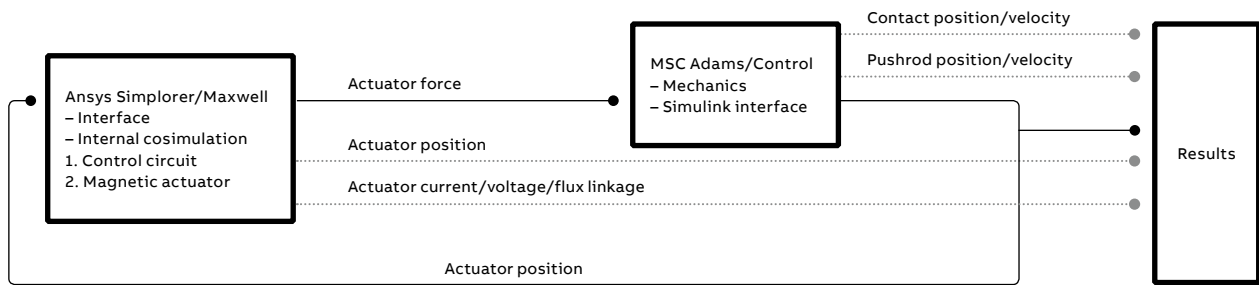

04

—
02 VM1 circuit-breaker arrangement [3].

—
03 VM1 circuit breaker, schematic view [3].

—
04 Cosimulation overview.

the axis of the linear actuator. The primary source of power is a capacitor, precharged to 100 to 400 V_{DC}, which is then applied to the appropriate actuator winding by the electronic controller. The transient nature of the electromagnetic actuator physics means that both the mechanics and the electromagnetics of the system need to be studied to understand the overall operation and to optimize its robust and efficient performance. For this reason, a cosimulation framework for the design of electromagnetic actuators has been developed.

Cosimulation – electromagnetic and mechanic coupling

Usually, for the development of MV actuators, either a simple mechanical model of the linkage and contact separation is inserted into the electromagnetics software tool, or a quasi-static force-over-position curve derived from the electromagnetics software tool is used with more sophisticated mechanical modelling. However, the use of so-called multibody simulation tools, eg, MSC Adams, and their extension with appropriate deformation, friction and clearance modelling is now indispensable for circuit-breaker development.

The accurate and robust behavior of circuit breakers is sensitive to the aforementioned mechanisms and neglecting them can give misleading indications. Therefore, a transient cosimulation environment has been introduced in which a time-stepping, quasi-transient electromagnetic finite element method (FEM) model of the actuator is coupled to a multibody mechanical model of the rest of the circuit-breaker system. The FEM actuator model uses Ansys Maxwell electromagnetic field

simulation software; the coupling to the multibody mechanical model (which is based on MSC Adams) is done using a combination of Ansys Simplorer, Matlab, Simulink and MSC Adams/Control. Simulink is a graphical programming environment for Matlab; Ansys Simplorer is a multidomain simulation software. An intermediate overview of the cosimulation framework is depicted in →4. Basically, the electromagnetic model feeds the force to the mechanical model, which returns the linear displacement to the electromagnetic model.

—
It makes sense to represent models of the poles, linkage and frame parametrically for re-use in a validated library.

MSC Adams – multibody simulation and coupling

The multibody simulation of circuit breakers must consider sophisticated and systematic modelling of joints with friction and clearance. This modelling is done in, for example, MSC Adams →5. It makes sense to represent models of the poles, linkage and frame parametrically for re-use in a validated library. The physical parameters are taken from the respective real designs.

The final coupling model is achieved via MSC Adams/Control. The input signal is the force variable, the output signal is at least the armature displacement, but the contact gap and velocity of the vacuum interrupter as well as the pushrod position and velocity may also be interesting.

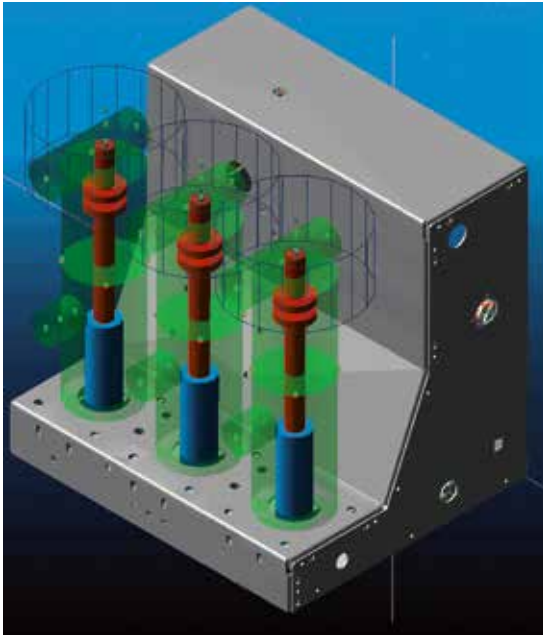

05

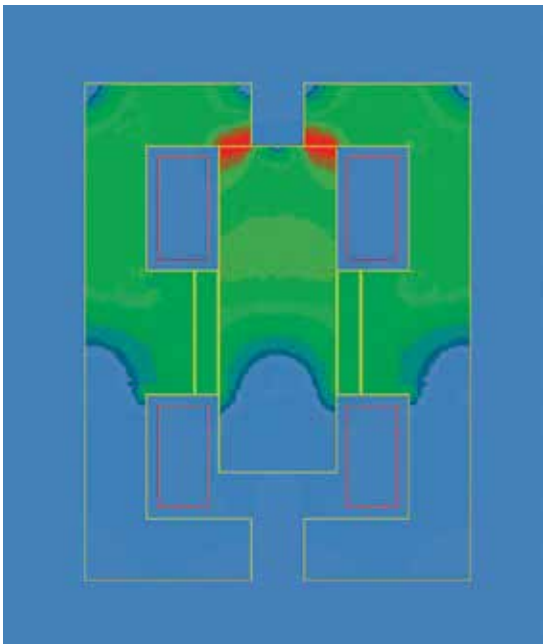

06

ANSYS Maxwell/Simplorer – electromagnetic simulation and coupling

The electromagnetic FEM model of the VM1 actuator is shown in →6. A 2-D model is used to decrease calculation effort while maintaining a good accuracy in terms of modeling the actuator's performance. Since the coils are wound using a thin wire, skin and proximity effects can be neglected, further simplifying the calculation. On the other hand, even though it makes the numeric solution more demanding, the partial magnetic saturation of the magnetic core is taken into

account by using an accurate magnetization curve, since the saturation plays an important role in the actuator's operation.

The time step size is defined by Ansys Simplorer, including the coupling to MSC Adams. The electromagnetic FEM model (Ansys Maxwell) is inserted as a transient cosimulation block, with Simplorer as the master. For the electrical circuit, it is beneficial to use a state-dependent switch that turns on after the decay of initial vibrations in the mechanical model (to make sure a steady initial state is reached) and turns off at a given value of the total stroke (to provide a basic controllability and limit the energy consumption). A more advanced state-dependent switching may also be implemented with Simplorer for modeling different current controllers and switching patterns, and designing more controllable circuit-breaker drives.

Matlab/Simulink – coupling and postprocessing

The final overview from the viewpoint of Matlab/Simulink is depicted in →4. The cosimulation is started from Matlab for the postprocessing of all interesting variables from electromagnetic and mechanic simulations. Cosimulation ensures that all integration schemes from Ansys Maxwell/Simplorer, MSC Adams and Matlab/Simulink run in parallel with the communication interval specified. In any case, when coupling with Ansys Simplorer, Simplorer will be the master of this top-level cosimulation.

—
Dynamic cosimulation extends classic quasi-static precomputation of the actuator force with dynamic coupling and eddy currents.

Cosimulation results

This section discusses typical results from a dynamic cosimulation for a linear electromagnetic drive.

Dynamic cosimulation extends classic quasi-static precomputation of the actuator force with two phenomena: dynamic coupling and eddy currents, both of which result in additional losses concerning the actuator force level. The realistic force level can only be well represented by the dynamic cosimulation and, depending on the actuator type, may be two to three times smaller than the one proposed by classic quasi-static simulation. As a result, quasi-static simulation overestimates, for example, closing velocities and results in

— 05 MSC Adams – multi-body dynamics model.

— 06 Ansys Maxwell – electromagnetic model [3].

— 07 shows the qualitative kinematic behavior expected for the closing of a circuit breaker, extracted from MSC Adams and Ansys Maxwell for verification.

misleading conclusions for the design of electromagnetic actuation of circuit breakers.

— The cosimulation framework for the design of, in particular, MV electromagnetic actuators has delivered exemplary results.

Cosimulation for electrical drives

The cosimulation framework for the design of, in particular, electromagnetic actuators for MV circuit breakers has delivered exemplary results. This framework can be easily applied to any kind of electromagnetic and mechanical coupling necessary for the design of electrical drives and may be helpful for the fast and automated development of actuators suited for the requirements of switch-gear for the future power grid. •

References

[1] Deutsche Energie-Agentur GmbH (dena); dena Ancillary Services Study 2030, "Security and reliability of a power supply with a high percentage of renewable energy," German Energy Agency Energy Systems and Energy Services, Berlin, 2013.

[2] Focus Online, "Stromnetz unter Druck – Betreiber zahlten 2017 fast eine Milliarde Euro für Noteingriffe." Available: https://www.focus.de/immobilien/energiesparen/foerderung-in-energie-wende-fehlt-stromnetz-unter-druck-betreiber-meldet-rekordkosten-fuer-noteingriffe_id_8180597.html

[3] ABB VM1 product brochure. Available: [https://library.e.abb.com/public/e090697e77f9425fbec2337890525a4d/Cat_VM1\(EN\)_M_1VCP000157.pdf](https://library.e.abb.com/public/e090697e77f9425fbec2337890525a4d/Cat_VM1(EN)_M_1VCP000157.pdf)

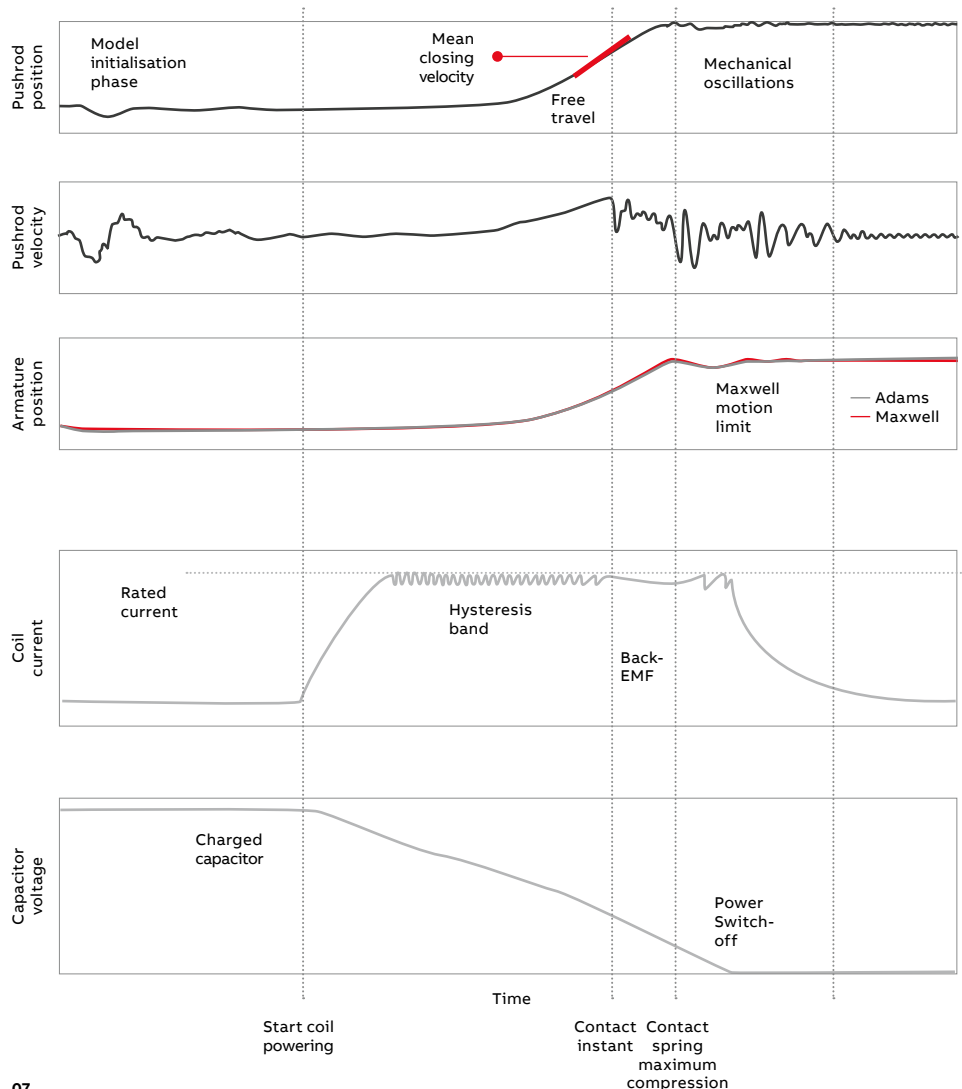

PRODUCTIVITY

Power transformer performance monitoring presented in SCADA

ABB's new field-tested model-based monitoring system is integrated within standard substation equipment and presented in MicroSCADA Pro. This unique approach allows an asset's performance to be evaluated while in actual service as well as imminent faults to be detected.

—
Tord Bengtsson
Nilanga Abeywickrama
Robert Saers
Subrat Sahoo
 ABB AB, Corporate
 Research, Västerås,
 Sweden

tord.bengtsson@
 se.abb.com
 nilanga.abeywickrama@
 se.abb.com
 robert.saers@se.abb.com
 subrat.sahoo@
 se.abb.com

In today's connected world customers demand greater reliability; this necessitates easy access to information about an asset's status; even assets like transformers that are not traditionally monitored → 1,2. To tackle this challenge, several monitoring methods have been developed to detect imminent problems experienced by power transformers and other devices in a power network. Currently, ABB offers a wide range of such asset monitoring systems [1].

Nonetheless shortcomings exist: the installation of modern monitoring systems requires specialized equipment and diverse proprietary software. Also, monitoring usually relies on condition assessment models based on data obtained from specialized sensors for gas in oil, temperature, dielectric losses, partial discharges, among others.

Furthermore, because the failure rate of power transformers is about one percent per year [2–4], most transformers are monitored manually by taking periodic offline measurements. The infrequency of these measurements heavily restricts the ability of the operators to react quickly to faults, or to correlate a reading to a system event.

Performance monitoring

Realizing these limitations, ABB's experts evaluated whether standard substation equipment could be used for monitoring while a transformer is in service, thereby complementing current online

monitoring systems. The advantages of such functionality would be consequential:

- There would be no need for specialized equipment; or, any additional hardware installations, ordinarily.
- The substation SCADA system could be used for data analysis, presentation, alerts and logging. By fully integrating the system with all other substation functionalities, communication to higher level systems would be achieved.

The extracted information would not only be relevant for a large number of known fault scenarios, one could also evaluate how well the monitored asset performs its duty – performance monitoring.

—
 ABB developed two unique monitoring applications that are integrated into MicroSCADA Pro.

Based on this, ABB has developed two unique monitoring applications: a power transformer performance monitor and a tap changer operation monitor. Both monitors are integrated into ABB's MicroSCADA Pro using this infrastructure for communication, presentation and alerts. To deliver the required measurements, substation modifications are limited to installation of monitoring applications and configuration of protection relays.



01

— 01 ABB operators and engineers provide customers with state-of-the-art technology such as monitoring systems to ensure optimal asset reliability.

Monitoring transformer performance

The power transformer performance monitor analyzes all voltages and currents in and out of a transformer to derive estimates of its turns ratio, short-circuit impedance and power loss [5–7]. These values can be directly compared to values on the name plate and from factory acceptance tests. Thus, the results are easy to interpret and the estimated sensitivity to changes are in accordance with the required precision of offline tests [8,9]. ABB's monitoring system allows several important transformer issues to be detected with great sensitivity, eg, shorted turns, deformed windings and eddy currents. By measuring the power loss online, operators receive a much faster indication of any change in transformer conditions than temperature can deliver. Such monitoring can reduce the frequency of traditional offline tests.

Moreover, new measurements are compared to historical measurements. Thus, sudden changes in the transformer performance, even miniscule changes, can be detected. Following a system incident such as a fault, performance can be compared before and after the incident. Furthermore, power system conditions that affect transformer performance, such as reverse power flow from renewable generation, can also be ascertained.

Model-based monitoring

The performance monitor samples steady-state waveforms of voltages and currents in and out of

the transformer at a regular interval, typically a few times per hour. Initially, the observed voltages and currents are used to set the parameters of a simple transformer model, the contribution from magnetization, R_m and X_m , can be separated from the winding impedances by using measurements made under varying load conditions; thus, all model parameters are determined →3.

— ABB's transformer monitoring system detects shortened turns, deformed windings and eddy currents with great sensitivity.

With the model parameters set, the monitor continuously delivers new estimates to detect any possible change. Every new measurement is compared to model predictions: This allows sudden performance changes to be recognized as fast as the measurement rate allows.

Nevertheless, limited accuracy is a challenge: voltage and current transformers are accurate within a range of one percent; the power loss of a modern transformer is typically less. ABB's extensive field tests show that individual instrument transformers are more sensitive to change than the accuracy rating implies (at least an order of magnitude better).



02

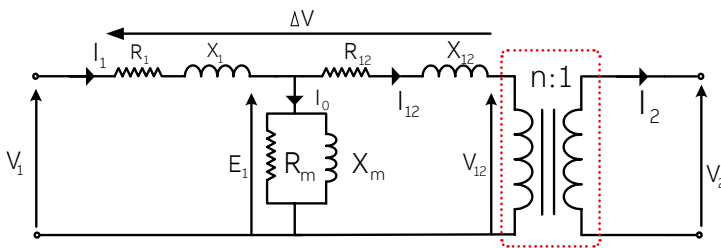

03

The performance monitor also delivers regular estimates of transformer ratio, impedance and magnetizing current; and evaluates both the power loss and deviations from model predictions for every new measurement.

Monitoring tap operation

The on-load tap changers are the only transformer parts that utilize mechanical movement and therefore account for approximately one-third of transformer failures [2–4].

Consequently, many methods have been explored to monitor tap changers [10–12]. These methods

are dependent on the use of additional sensors for vibration or motor current and do not, therefore, provide a clear estimate of the commutation time – a crucial additional performance indicator.

ABB’s tap changer operation monitor analyzes the transformer internal loss during a tap change with the same voltage and current signals as does the performance monitor. This novel monitor provides an estimate of the commutation time and the extra power loss associated with commutation.

—
 The novel tap changer operation monitor analyzes the transformer internal loss during a tap change.

A transition time that is too brief indicates a risk for an arc that bridges the tap contacts; a transition time that is too long indicates mechanical problems. ABB’s investigation shows that changes in the commutation power loss are due to the transition resistors: the expected power loss can be determined from the tap changers’ name plate.

02 Customers require immediate, accurate information about a transformer's performance and the operators' terminal in the control room is the best place for the presentation of results.

03 Conventional equivalent circuit of a two-winding transformer referred to the primary side.

04 Extra loss observed during tap change, the gray and black lines show the contribution from individual phases and the colored line denotes the total. Here, one phase opens the main contact about two ms after the others.

05 The history of current deviation from expected values are shown. In this special case, a sympathetic inrush event occurred on May 22 that caused a permanent change of the transformer parameters. Significantly, this change is minute (30 mA) in comparison to noise and, in absolute terms, to the nominal load current (about 0.5 A).

Tap operation monitor function

A tap changer does not simply shift to another number of turns in the transformer, it shifts the turns ratio in successive steps to avoid excessive arcing and other potential dangers. A circulating current between the old and the new tap positions is driven by the voltage difference and limited by the transition resistors.

The circulating current causes a temporary additional loss that can be extracted through a careful signal analysis →4. The commutation time and the resistor value can be estimated from the duration and magnitude of the additional loss.

Tap operation monitoring analyzes waveforms recorded during a tap change for the tap-change additional power loss. Such records are readily obtained from an adequately configured disturbance recorder.

Transformer performance case studies

Field cases exemplify just how sensitively transformer performance can be monitored with ABB's revolutionary monitoring solutions. Deviations from the model can unveil information about the occurrence and timing of an event, and more importantly, the cause.

Permanent change due to saturation

In one case ABB evaluated a transformer incident that occurred on May 22, when the current deviation from the established model changed abruptly →5. Because this change is not dependent on the load, it was attributed to the presence of a magnetizing

current. The timing of change correlated with energization of a transformer located nearby. The associated voltage effect is postulated to have driven the transformer to saturation; this created permanent eddy current paths in the structural parts. Nonetheless, the transformer remained in service because the increase in power loss was relatively low, about 20 percent of the losses at no load.

Temporary high loss due to external conditions

Because power system conditions, external to the transformer, can also affect performance, ABB evaluated power loss in a real-world field study.

Field cases exemplify how sensitively transformer performance can be monitored with ABB's revolutionary monitoring solution.

The studied 50 MVA transformer had a history of generating thermal alarms due to elevated temperature. An abnormal power loss was registered precisely by the performance monitor →6. There was no permanent change in transformer properties because the observed increase in power loss was temporary. On several past occasions, increased power loss was also observed and was correlated to operation at a small hydro-power station, located at the secondary side. ABB's novel monitoring system established the timing and likely cause of the event. Findings such as this corroborate the need for monitoring renewable power production.

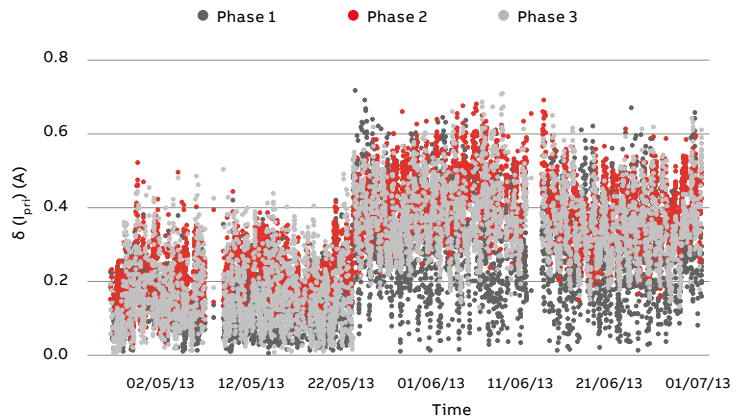
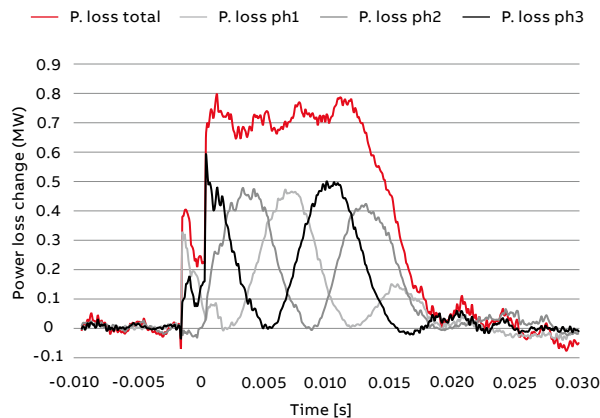

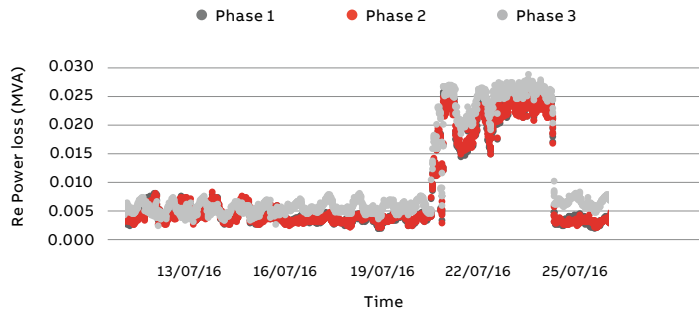

06

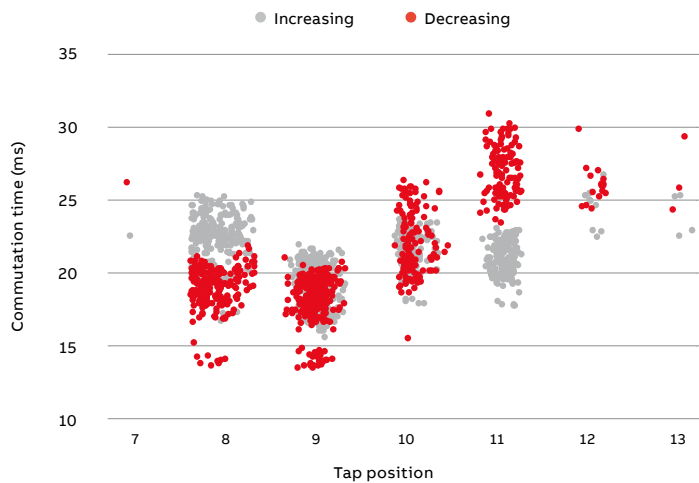

07

Commutation time variation

For some tap changer designs, the commutation time may vary between positions. To illustrate this, ABB estimated commutation time for a few thousand operations of one tap changer in service →7. The observed time differences between taps are significant and indicate contact wear has occurred and this tap changer should be scheduled for maintenance.

MicroSCADA Pro implementation

A Supervisory Control and Data Acquisition (SCADA) environment is ideal for the presentation of monitoring results because most other aspects of substation operation, such as event handling and cyber security are readily available.

A properly configured protection IED serves as an acquisition unit; the disturbance records are made available by IEC 61850-8-1. Preprocessed results

are then sent to the SCADA application process objects in ABB’s MicroSCADA Pro terminology.

The use of standard IEDs for basic signal acquisition eliminates not only the need for dedicated acquisition hardware, it also enables the use of either conventional (110V/5A) or digitized signals on the substation process bus for monitoring.

An update of process objects that belong to a specific MicroSCADA Pro function triggers additional analysis and attention indicators, eg, transformer ratio, loss, impedance, current difference, tap operation time and trend. Currently, a few dozen attention indicators are calculated: each is expressed in specific units of an acceptance limit. Thus, an attention indicator value of one means that the monitored quantity is precisely that of the acceptance limit.

—
ABB’s MicroSCADA Pro is ideal for the presentation of results because other aspects of substation operation are readily available.

The attention indicators can be summarized as a single main indicator – using the maximum value of all. This indicator is then used to control the appearance of the monitoring symbols →8. Thanks to this notification, the operator can click the symbol for additional information. An attention indicator that exceeds the acceptance limit will trigger a MicroSCADA Pro event – the event log then identifies the indicator and timing. The monitoring dialogs present all recent data and analytical results, eg, the transformer model parameters for each phase and tap positions utilized can be displayed →8.

Thanks to the MicroSCADA Pro application, further processing and logging is facilitated – selected results can be communicated to fleet-level asset management systems. Furthermore, the monitoring applications generate their own logs, which can be sent for detailed analysis to ABB’s remote experts.

Ushering in new monitoring capability

The presented method and results illustrate ABB’s new approach to monitoring: additional monitoring functions are fully integrated into standard substation equipment. The monitors not only serve to detect imminent faults; they also evaluate the assets’ performance in actual service.

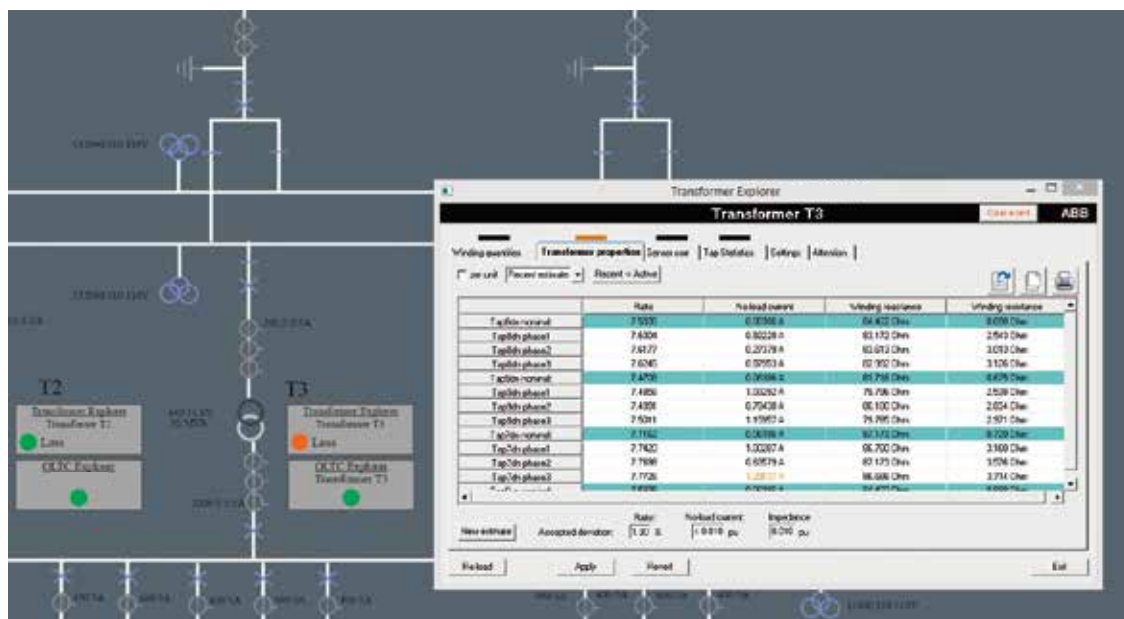

08

The process display shows a line diagram with a number of transformers, next to those are symbols indicating the monitoring status of the transformers. By clicking a symbol, the user interface pertinent to this symbol appears. In this example it shows estimated ratio, no-load current and winding impedance as estimated by the performance monitor for each phase and tap position used. The blue lines indicate nominal values calculated from name plate and one value is outside accepted deviation as indicated by the yellow coloring.

06 Example of power loss graph from a field case where power production on the low voltage side caused increased losses in this transformer.

07 Commutation times as a function of tap position for about 1750 tap operations in service. Increasing operations are in grey whereas decreasing operations are in red.

08 Screenshot from a SYS600C computer running MicroSCADA Pro.

To date, ABB has successfully field tested the monitoring applications on eight power transformers ranging from 30 to 1,000 MVA and from 120 to 750 kV. Data gathered from approximately ten transformer years and 10,000 tap operations have been recorded; this data provides rigorous support for ABB's novel approach.

Intent on bringing customers the best monitoring systems possible today and in the future, ABB continues to explore additional functionalities utilizing a similar structure. •

Acknowledgements

The authors wish to thank their colleagues from ABB business units for their support and encouragement.

References

- [1] ABB product guide, available under: <https://new.abb.com/products/transformers/service/advanced-services>
- [2] CIGRÉ Working Group 05, "An international survey on failures in large power transformers in service," *Electra*, no. 88, May 1983.
- [3] F. Vahidi, S. Tenbohlen, "Statistical Failure Analysis of European Substation Transformers," *ETG-Fachbericht – Diagnostik elektrischer Betriebsmittel*, 2014 pp. 5–9.
- [4] M. Minhas, et al., "Failure in power system transformers and

- appropriate monitoring techniques," presented at the 11th Int. Symp. High Voltage Engineering, London, U.K., 1999.
- [5] T. Bengtsson and N. Abeywickrama, "On-line Monitoring of Power Transformer by Fundamental Frequency Signals," *Cigré* 2012, Paper A2-110.
- [6] N. Abeywickrama, et al., "Transformer Explorer – monitoring transformer status by fundamental frequency signals", *Condition Monitoring and Diagnostics (CMD) Conference*, X'ian, China, Sept. 25–28, 2016, Paper 116.

- [7] S. Sahoo, et al., "Monitoring Power Transformer Performance, Usage and System Event Impacts – A Case Study," 3rd International Conference on Condition Assessment Techniques in Electrical Systems (CATCON), Nov. 2017.
- [8] IEEE Guide for diagnostic field testing of electric power apparatus – Part 1: Oil filled power transformers, regulators, and reactors, IEEE Std. pp. 62, Dec. 1995.
- [9] Power transformers – Part I: General, IEC 60076-1.

- [10] T. Bengtsson, et al., "Acoustic Diagnosis of Tap Changers", *Cigré* 1996, Paper 12–101.
- [11] R. Jongen, et al., "On-load tap changer diagnosis with dynamic resistance measurements," *IEEE International Conference on Condition Monitoring and Diagnosis*, Bali, 23–27 Nov. 2012, pp. 485–488.
- [12] K.G. Lewis, et al., "A tap-changer monitoring system incorporating optical sensors," *Second International Conference on the Reliability of Transmission and Distribution Equipment*, Coventry, UK, 1995, pp. 97–102.

BUZZWORD DEMYSTIFIER

Hybrid

This quarter we have less of a demystifier article and veer more towards philosophy. Because we all know what the word hybrid means, right? Or at least we think we do and therein lies the challenge for the word hybrid in 2019: it's become a buzzword.



Michelle Kiener
ABB Review
Baden-Daettwil,
Switzerland

michelle.kiener@
ch.abb.com

Type the word hybrid into google and the first thing that comes back is a definition for a hybrid vehicle. In fact, I conducted a small informal survey for this Buzzword Demystifier. I asked people "What's the first thing that comes into your head when I say hybrid?" and nearly everyone replied "cars".

But hybrid is so much bigger than that. The trigger for hybrid as a buzzword topic came from your author walking past a bicycle shop and seeing some e-bikes labelled "hybrid bikes". As an owner of both a hybrid car and an e-bike the labels caught my eye. I excitedly deviated from my intended food shopping objective to find out more. I was expecting to be amongst the first to see e-bikes with energy recovery, a hybrid of my car and my bike in fact. Instead, I found out that the hybrid aspect of these hybrid e-bikes was that they are a mix of a road bike and a mountain bike.

I haven't even defined my hybrid car correctly above. Despite the very nature of the technology demanding that my car be quite light, it's a "heavy hybrid" that has a petrol and an electric motor and uses energy recovery to charge the battery. As opposed to a plug-in hybrid, which is helpfully named to clarify that it must be plugged in to charge its battery. So I made a heavy hybrid assumption about the hybrid e-bikes. A plug-in hybrid owner may not have jumped to the same conclusion. And the word hybrid means something else entirely to keen gardeners. The roses at the start of this article are hybrid tea roses →1.

From the Latin hybrida, a variant of ibrida "mongrel," specifically meaning "offspring of a tame sow and a wild boar", the word hybrid seemed to



01

first emerge in c. 1600 and was used to refer to the "offspring of plants or animals of a different variety or species". Around about 2002 hybrid started being used as a short form of hybrid vehicle [1].

The Merriam Webster dictionary [2] defines Hybrid as:

- 1 an offspring of two animals or plants of different races, breeds, varieties, species, or genera a hybrid of two roses
- 2 a person whose background is a blend of two diverse cultures or traditions
- 3a something heterogeneous in origin or composition: composite
- 3b something (such as a power plant, vehicle, or electronic circuit) that has two different types of components performing essentially the same function

To be fair to the bicycle sellers, who I thought were perhaps being rather cheeky and jumping on the hybrid bandwagon to lure people in, perhaps I should have checked Wikipedia first [3]. There, in addition to the expected definitions of hybrid for biology (think of the tea roses above) hybrid vehicle, plug-in hybrid and hybrid train there, indeed, was hybrid bicycle, defined as "a bicycle with features of road and mountain bikes". But in addition was a fascinating list including, for example, hybrid library, hybrid market, hybrid gemstone and, of course, hybrid word. All perfectly valid uses of hybrid, but since 2002 becoming increasingly overshadowed by the shortening of hybrid vehicle to just hybrid.

And therein lies the modern challenge for the word hybrid. No longer restricted to sows and boars it is now, either overused or the victim of a narrow



02

01 A hybrid – the Chrysler Imperial hybrid tea rose.

02 Not a hybrid – the Chrysler Imperial car.

References

[1] Online Etymology Dictionary “hybrid (n.)” [online]. Available: <https://www.etymonline.com/word/hybrid> [Accessed: July 6, 2019].

[2] Merriam-Webster “hybrid” [online]. Available: <https://www.merriam-webster.com/dictionary/hybrid> [Accessed: July 25, 2019].

[3] Wikipedia “Hybrid” [online]. Available: <https://en.wikipedia.org/wiki/Hybrid> [Accessed: July 23, 2019].

The centuries-old term “hybrid” is no longer restricted to sows and boars, it’s become a buzzword.

assumption. In the world of technology hybrid has, in some ways, fallen victim to the “apple phenomena”: first there was the iMac, then the iBook, followed by iPod, iPhone and iPad. Now, businesses who’d like to imply the same innovation and design chic put i in front of their product name, technology based or not. I’ve even seen an iUmbrella. In the technology arena some use the word hybrid to imply environmental benefit, true or otherwise, and at the same time some of us see the word hybrid and make assumptions about the product, its behavior and benefits. As always in life hybrid now essentially boils down to “always check the small print”. Otherwise you may take delivery of a bargain Hybrid Chrysler Imperial that you have to plant in your garden, rather than park in your garage →2. •

Subscribe

How to subscribe

For a subscription, please contact your nearest ABB representative or subscribe online at www.abb.com/abbreview

ABB Review is published four times a year in English, French, German and Spanish. ABB Review is free of charge to those with an interest in ABB’s technology and objectives.

Stay informed...

Have you ever missed a copy of ABB Review? Sign up for the e-mail alert at abb.com/abbreview and never miss another edition.



Please note that when you register for this alert, you will receive an e-mail with a confirmation link. Please ensure that you have confirmed your registration.

Imprint

Editorial Board

Bazmi Husain

Chief Technology Officer
Group R&D and Technology

Adrienne Williams

Senior Sustainability
Advisor

Christoph Sieder

Head of Corporate
Communications

Reiner Schoenrock

Technology and Innovation

Roland Weiss

R&D Strategy Manager
Group R&D and Technology

Andreas Moglestue

Chief Editor, ABB Review
andreas.moglestue@ch.abb.com

Publisher

ABB Review is published by ABB Group R&D and Technology.

ABB Switzerland Ltd.
ABB Review
Segelhofstrasse 1K
CH-5405 Baden-Daettwil
Switzerland
abb.review@ch.abb.com

Partial reprints or reproductions are permitted subject to full acknowledgement. Complete reprints require the publisher’s written consent.

Publisher and copyright ©2019
ABB Switzerland Ltd.
Baden/Switzerland

Printer

Vorarlberger
Verlagsanstalt GmbH
6850 Dornbirn/Austria



Layout

Publik. Agentur für
Kommunikation GmbH
Ludwigshafen/Germany

Artwork

Konica Minolta
Marketing Services
London,
United Kingdom

Disclaimer

The information contained herein reflects the views of the authors and is for informational purposes only. Readers should not act upon the information contained herein without seeking professional advice. We make publications available with the understanding that the authors are not rendering technical or other professional advice or opinions on specific facts or matters and assume no liability whatsoever in connection with their use.

The companies of the ABB Group do not make any warranty or guarantee, or promise, expressed or implied, concerning the content or accuracy of the views expressed herein.

ISSN: 1013-3119

abb.com/abbreview

Tablet version

Production of the tablet version of ABB Review (for both iOS and Android) was discontinued at the end of 2018. Readers of the tablet versions are recommended to use the pdf or web versions instead.
abb.com/abbreview





01|2019

Ideas matter

Innovation highlights

- 06 Innovation short stories
- 21 ABB Customer World

Partnerships

- 24 Interview with SynerLeap
- 28 SynerLeap, Graphmatech and Algoryx

Connected for productivity

- 36 Charting a course to autonomous shipping
- 39 ABB Ability™ Power Transformer
- 46 Noninvasive sensor technology
- 54 ABB's ring bus with static UPS
- 61 New ABB Tmax XT circuit breakers

Drivechains and converters

- 64 New bearing sensor enhances safety
- 68 Tool-free, push-in wiring

Buzzword demystifier

- 70 Deep learning



02|2019

Digital twins and simulations

Digital twin and simulations

- 08 World of simulation
- 14 Edge-Cloud synergy with digital twins
- 20 Electrothermal simulations
- 26 HVDC Light® digital twin
- 34 Connected analytics
- 42 Easy simulations for engineers
- 47 Advanced simulations
- 52 Digital avatars for powertrains
- 58 Monitoring of rotating machines
- 64 Mitigating internal arc impact

Productivity

- 72 Process module engineering

Buzzword demystifier

- 78 Cloud, edge and fog computing



03|2019

Autonomous systems

Autonomous systems

- 08 From automation to autonomous systems
- 16 Visualizing power network models
- 23 Smart visualizations
- 30 Plant orchestration and pilot application
- 36 Data analytics tools for industry
- 44 Drive Connectivity Panel
- 46 Grinding mill liner monitoring

Energy

- 54 PowerLine DPA UPS for harsh conditions
- 60 The fuel cell – a green powerhouse
- 68 Rupture-resistant transformers

Buzzword demystifier

- 74 Autonomous systems

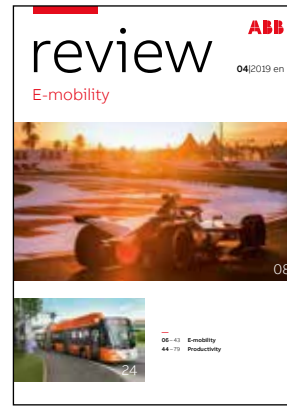

04|2019

E-mobility

E-mobility

- 08 Racing into the future
- 14 Electrifying Niagara Falls ferries
- 18 Welcome aboard hydrogen
- 24 Why electric bus range does not matter
- 30 The future of the power grid
- 38 Collaborating on EV infrastructure

Productivity

- 46 Machines learning machines
- 52 Optimizing the entire powertrain
- 56 Virtual prototyping of sensor systems
- 64 Asset optimization
- 68 Circuit-breaker drives
- 74 Performance monitoring in Scada

Buzzword Demystifier

- 80 Hybrid

Next 01/2020

Inspiring tomorrow

The new decade's first ABB Review will go beyond a summary of what is possible. It will reveal the new technologies, customer use cases, and process development approaches that will be necessary for competitive success and, thereby, should inform and challenge your planning. Think of it as a user's guide to activating the future.