

## Setup Instructions

### Wireless LAN Module (built-in)

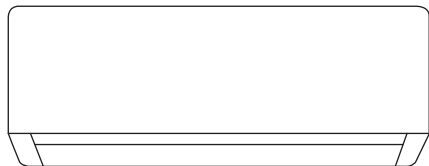

**Setup Instructions** 2-23  
**Wireless LAN Module (built-in)**  
Please read these operating instructions thoroughly and keep them for future reference.

**Instructions de configuration** 24-45  
**Module LAN sans fil (intégré)**  
Veuillez lire ce mode d'emploi dans son intégralité et conservez-le pour toute référence ultérieure.

**Instrucciones de funcionamiento** 46-67  
**Módulo LAN inalámbrico (integrado)**  
Sirvase leer atentamente estas instrucciones de funcionamiento y conservarlas para futuras consultas.

**Einrichtungsanleitung** 68-89  
**WLAN-Modul (eingebaut)**  
Bitte lesen Sie diese Bedienungsanleitung aufmerksam durch und bewahren Sie sie als künftige Referenz auf.

English

Français

Español

Deutsch



# Built-in Network Adaptor that allows you to control your air conditioning unit operation from anywhere.

Thank you for purchasing this Panasonic product.

## Table of Contents

Safety Precautions .....	2-3
System Overview .....	4
How to Use .....	5-18
Network Adaptor & App FAQs .....	19-21
Troubleshooting .....	22
Information .....	22-23
Copyright .....	90-94

## Safety Precautions

Before attempting to control / operate this air-conditioner product via wireless communication from a remote location, make sure to check the installation of the appliance and its surrounding area, and, be wary of any person(s) within the vicinity.

To prevent personal injury, injury to others or property damage, please comply with the following:

Incorrect operation due to failure to follow instructions below may cause harm or damage, the seriousness of which is classified as below:

 <b>WARNING</b>	This sign warns of death or serious injury.
---	---

 <b>CAUTION</b>	This sign warns of injury or damage to property.
---	--

The instructions to be followed are classified by the following symbols:



This symbol denotes an action that is **PROHIBITED**.



This symbol denotes an action that is **COMPULSORY**.



## WARNING

### Network Adaptor (activated)



Do not use the indoor unit near to any medical equipment or automatic control equipment (automatic door, wire alarms, etc.).  
(Radio wave from indoor unit may interfere with the equipment and may cause incident due to malfunction)

# Safety Precautions



Keep at least 15 cm away from the indoor unit if you have a cardiac pacemaker.

(Radio wave from indoor unit may interfere with the operation of pacemaker)



## CAUTION

### Network Adaptor (activated)



Check the following requirements in advanced (At home):

- Insert the power supply thoroughly. Ensure no dust builds up on the power supply.  
(This can cause fire due to ignition in the power supply's or poor contact)
- Check the status of timer activation set by other persons.  
(Unexpected run-stop operation may cause harm to human body, pets, and plants)
- There should be no abnormality in the air conditioner such as change of airflow. Ensure no object(s) which may be displaced easily due to the airflow blowing directly at it. The fallen or moved object(s) might lead to danger such as fire, injury etc.
- At all times, use the in-house remote control when there is a possibility of person(s) (such as infant, children, disabled person(s), elderly or sickly person(s)) who are incapable of controlling the temperature themselves and rely on the pre-set configuration of the air-conditioner. The rise and drop in the temperature due to remote operation might cause the occupant(s) to experience discomfort and/or disrupt their daily routine.  
Plant(s) and animal(s) are likely to be affected by sudden temperature adjustments.



Check the following requirements before operating the air conditioner from a remote location:

- Do inform the person(s) in the vicinity of the area being air-conditioned that you will remotely control the air conditioner operation and settings. This is to avoid any possibility of serious effects on person(s) either due to being taken by surprise or due to sudden changes in temperature (from comfort to cold or vice versa). (This may cause harm to human body due to sudden changes of outside temperature and room temperature. Temperature adjustment can be operated by remote control)
  - If the main display of the Panasonic Comfort Cloud app does not reflect the status of the operation, please use the in-house remote control to operate the air-conditioner.
- As the app uses network communication, there may be times when remote operation is not possible due to communication and/or network failures (such as Panasonic Cloud server downtime, telecom providers' server downtime, WIFI connectivity etc.). In the event of such failure(s), please use the in-house remote control to operate the air-conditioner.

# System Overview

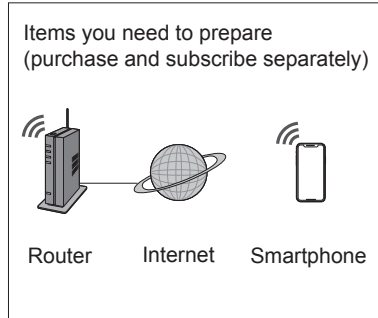
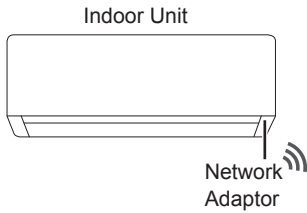

Download from app store

Panasonic Comfort Cloud app (free)

- This feature requires the app to work with a smartphone with Android 5.0 and above, or with iOS 9 and above. However, there is no guarantee that the app will work well with all versions.
- The Network Adaptor is designed specifically as a terminal for “Panasonic Comfort Cloud” app.
- The Wireless LAN network coverage must reach the indoor unit installation location.

## Specification

Network Adaptor	Wireless LAN Module (built-in)
Model	DNSK-P11
Input Voltage	DC 5V (From Air Conditioner Indoor Unit)
Current Consumption	Tx/Rx max. 290/100 mA
Wireless LAN standard	IEEE 802.11 b/g/n
Frequency range	2.4 GHz band
Encryption	WPA2-PSK (TKIP/AES)

## Precaution

- Do NOT disassemble or alter this Network Adaptor in any way.
- Do NOT remove this Network Adaptor from the indoor unit during operation.
- Data transmitted and received over radio waves may be intercepted and monitored.

## Maximum radio-frequency power transmitted in the frequency bands

Type of wireless	Frequency band	Max. EIRP (dBm)
WLAN	2412 - 2472 MHz	20 dBm

# How to Use

## Usage precaution

- Before using the product, be sure to read all the precautions in this manual. The Company is not liable for any defects and damages incurred by the use of this product that occur through incorrect use by yourself or a third party, unless legal liability is recognized in regard to failures.

## Security measure

- Wireless LAN uses radio waves to exchange information. Therefore, there is a risk of unauthorized access.
- Initialize the app settings on the product prior to disposal or transferring to a third party.

## Before setting the network connection

- Confirm the wireless router is connected to the network correctly.
- Confirm the Wireless LAN of the smartphone is activated.
- Confirm your smartphone and this product are connected to the same wireless router.

## App Installation

For Android user (Android 5.0 and above)

- Open .
- Search for "Panasonic Comfort Cloud" app.
- Download and install.

For iOS user (iOS 9 and above)

- Open .
- Search for "Panasonic Comfort Cloud" app.
- Download and install.

## Note

- The app user interface may change without notice when there is a version upgrade.
- There is no charge to use this app. However, other charges may be incurred for network connection and operation.

## Starting "Panasonic Comfort Cloud"

### Create New Panasonic ID

Use "Panasonic Comfort Cloud" app as an option to control this product.

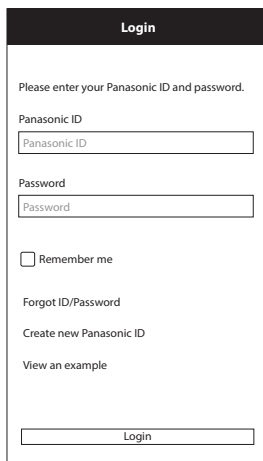

**Login**

Please enter your Panasonic ID and password.

Panasonic ID  
Panasonic ID

Password  
Password

Remember me

[Forgot ID/Password](#)

[Create new Panasonic ID](#)

[View an example](#)

Login

- For new user, select "Create new Panasonic ID" to register.
- For registered user, log in using your Panasonic ID and password.

# How to Use

## App Setting

### Add new air conditioner

- Before using the “Panasonic Comfort Cloud” app, you need to register this product.

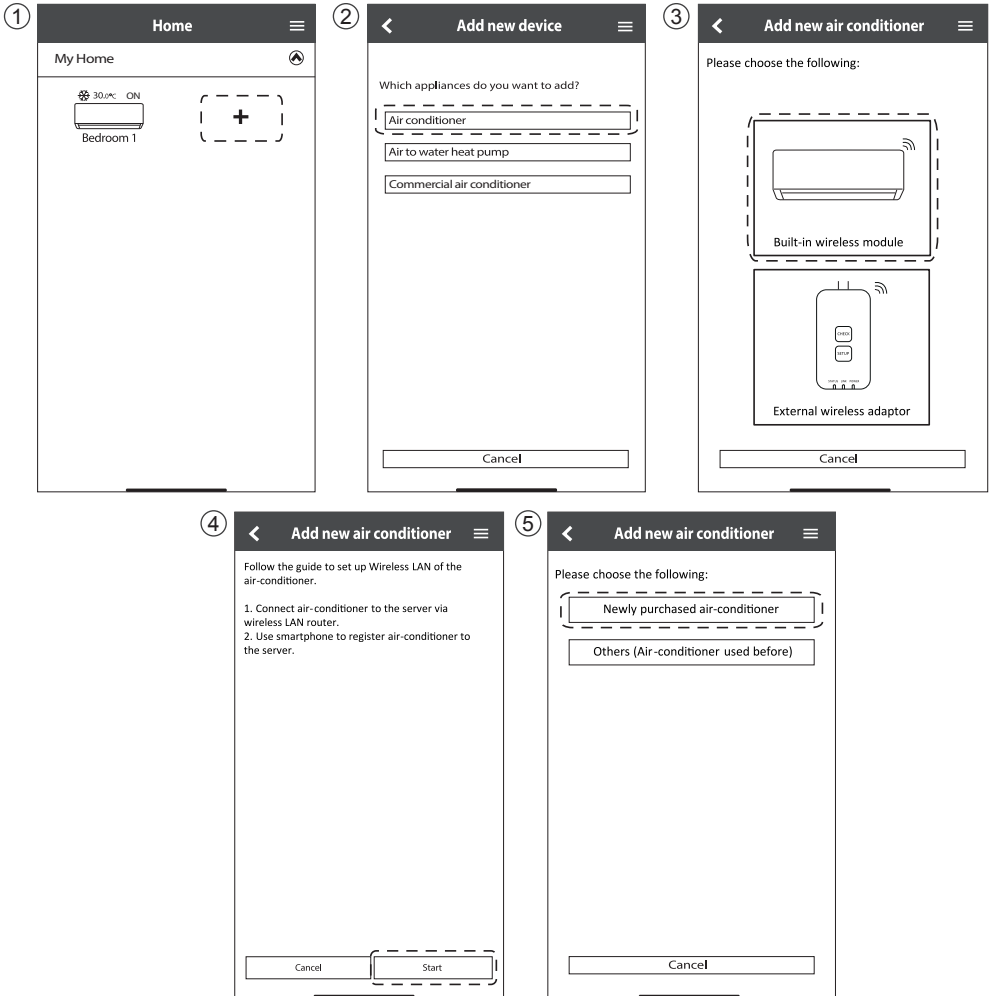

## Setting connection network

- ① Check that the Wireless LAN LED is ON. Point the remote control to the air conditioner and press the Wireless LAN  button until the Wireless LAN LED starts blinking.

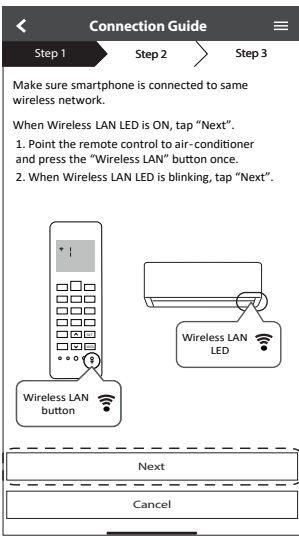

Fast blink	The unit is establishing the connection.
Slow blink	The unit is not securing the connection.
No blink (stays on)	The unit has established the connection.

- It can establish the connection to the unit even if the unit is turned OFF.

### Note

- If the Wireless LAN LED blinks continuously and you do not want to use the app, press the Wireless LAN  button to turn it off.

- ② Select the status of the Wireless LAN LED.

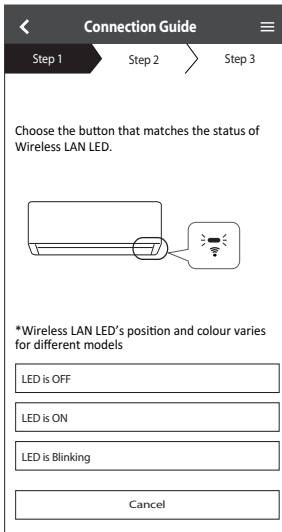

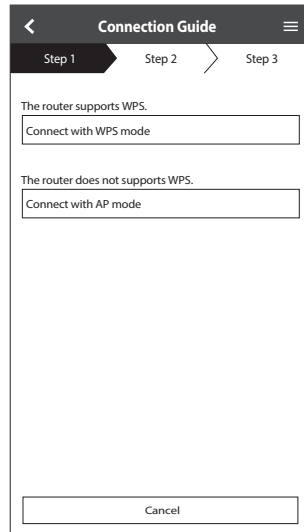

- ③ Select the preferred connection setup mode.



# How to Use

## Connection network using WPS mode (method 1)

- ① Press the WPS button on the router that will be connected to the air conditioner.
  - Check that the Wireless LAN LED is ON. If the Wireless LAN LED is OFF, press the Wireless LAN  button to turn it on, and enable Wireless LAN connection.
- ② Check that the Wireless LAN LED is ON. Press the Wireless LAN  button for 5 seconds until "1" appears on the remote control. Point the remote control to the air conditioner and press .

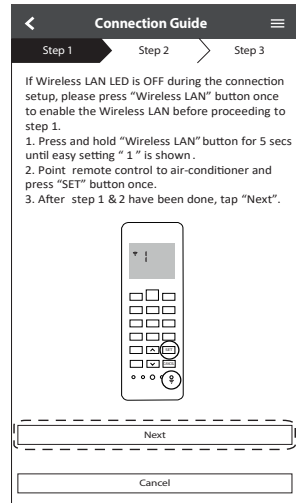
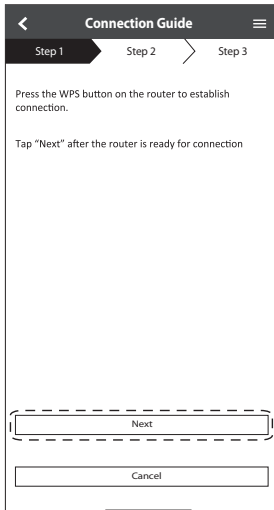

- ③ When the air conditioner is successfully connected to the router, the Wireless LAN LED stops blinking and turns ON.
- ④ If the Wireless LAN LED keeps blinking, check the wireless router connection.

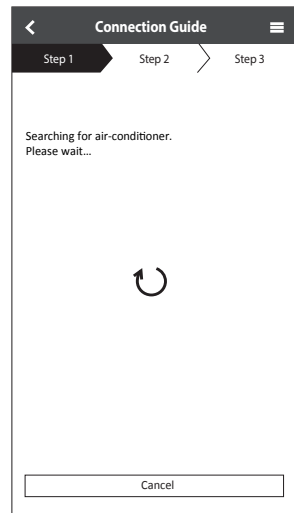
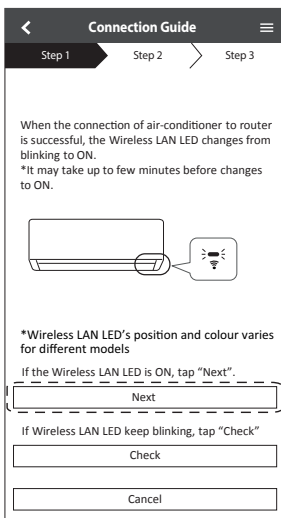





## Connection network using AP mode (method 2)

(For Android 5.0 and above & iOS 11 and above only)

- 1 Check that the Wireless LAN LED is ON. Press the Wireless LAN  button for 5 seconds until "1" appears on the remote control.

Press  until "2" appears. Point the remote control to the air conditioner and press .

Join to connect to the "Panasonic-CS-wirelessAP" network.

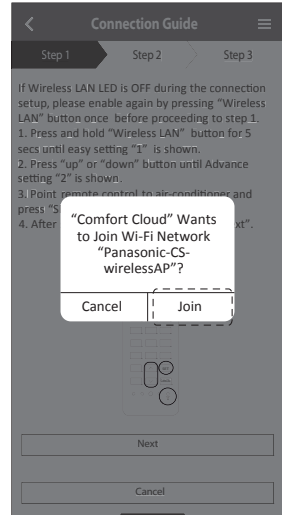
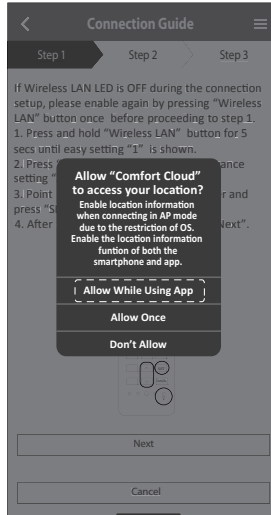
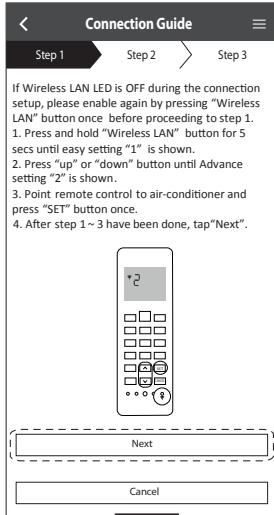

- 2 Enter the password of the selected wireless router and continue.

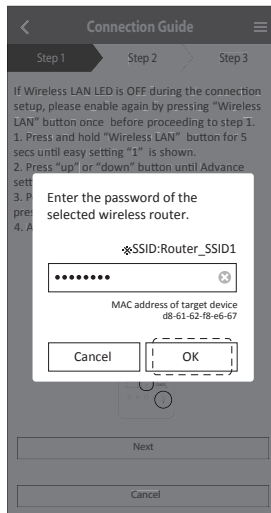

# How to Use

- ③ When the air conditioner is connected to the router successfully, the Wireless LAN LED stops blinking and turns ON. When the Wireless LAN LED is ON, connect your smartphone to the wireless router to continue the setup.
- If the Wireless LAN LED keeps blinking, check the wireless router connection.

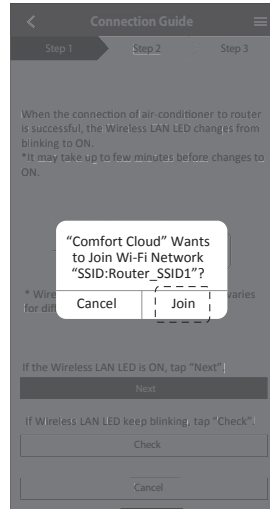
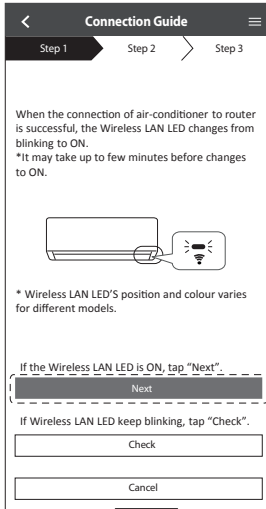

## Select the air-conditioner and set the password

- 1 Select the model to register your air-conditioner.

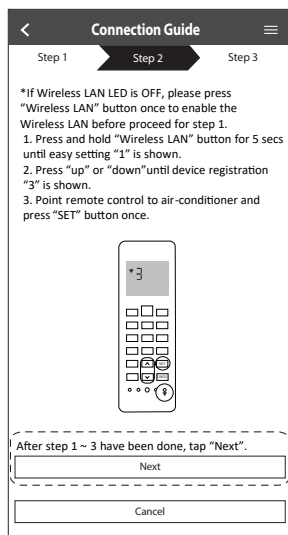
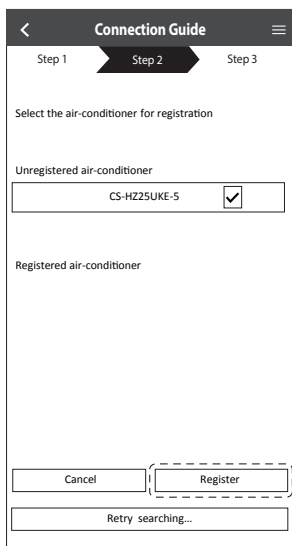

- 2 Set a password to complete the registration. The password must be 8-15 characters with letters and numbers.

### Note

- Keep the password for future use. You can use the same password when you register other Panasonic devices.

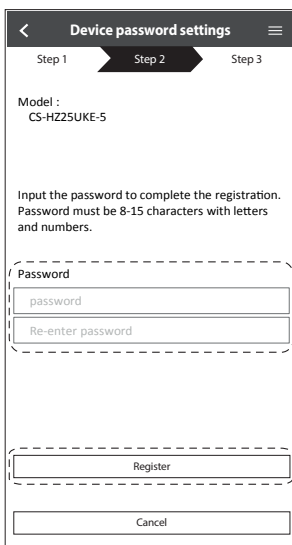

# How to Use

## Registration completed

- ① After registration and connection is established between the app and your air conditioner, set the preferred name to identify your air conditioner easily.
  - After registering your preferred name for your air conditioner, you can use the “Panasonic Comfort Cloud” app functions.
- ② Beside operation control, this application can monitor the estimated energy consumption and do comparison for different time frame by referring to the statistic's graph.

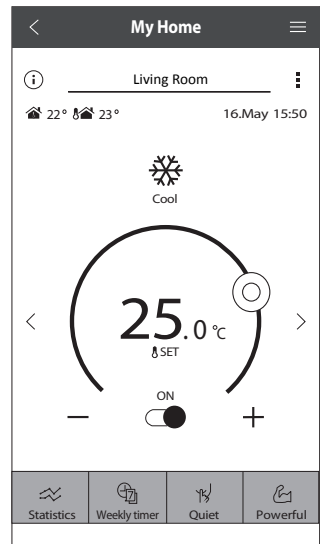
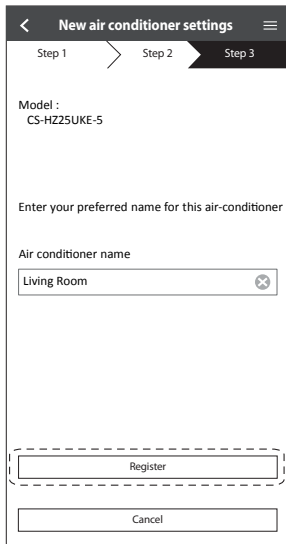

## Note

- Check the app's connectivity status before and during operation. If the status is not reflected, use the remote control to operate your air conditioner.

## Launch the App

- ① Log in to the “Panasonic Comfort Cloud” app.
- ② Select your air conditioner to control.

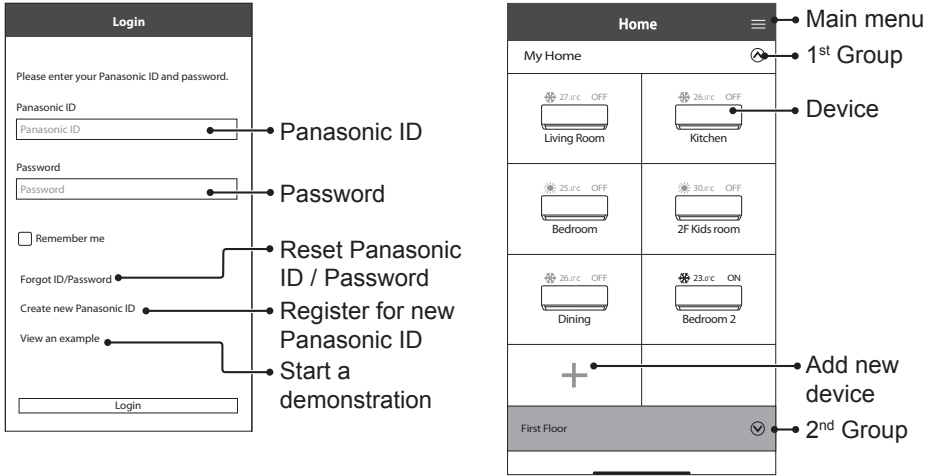

## Main Device Screen - Operation Setting

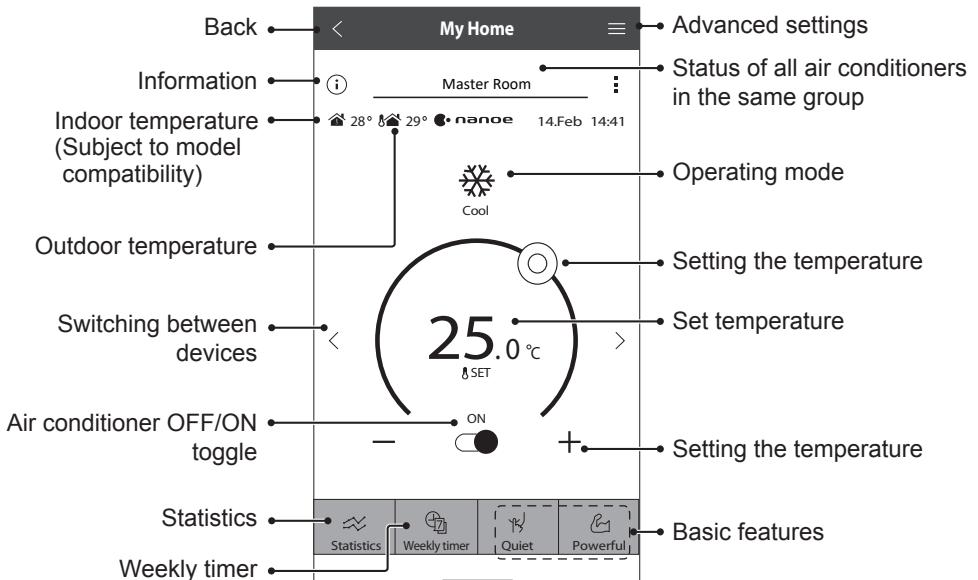

# How to Use

## Information

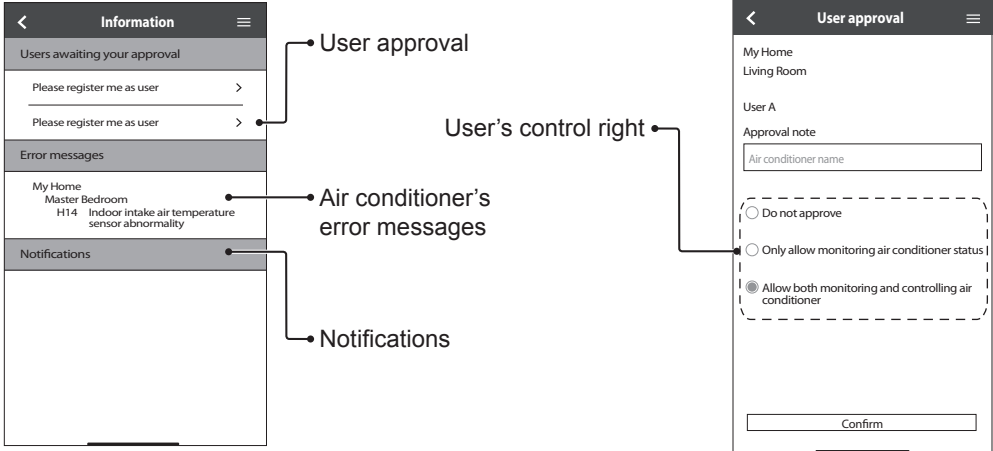

## Air Conditioner Status

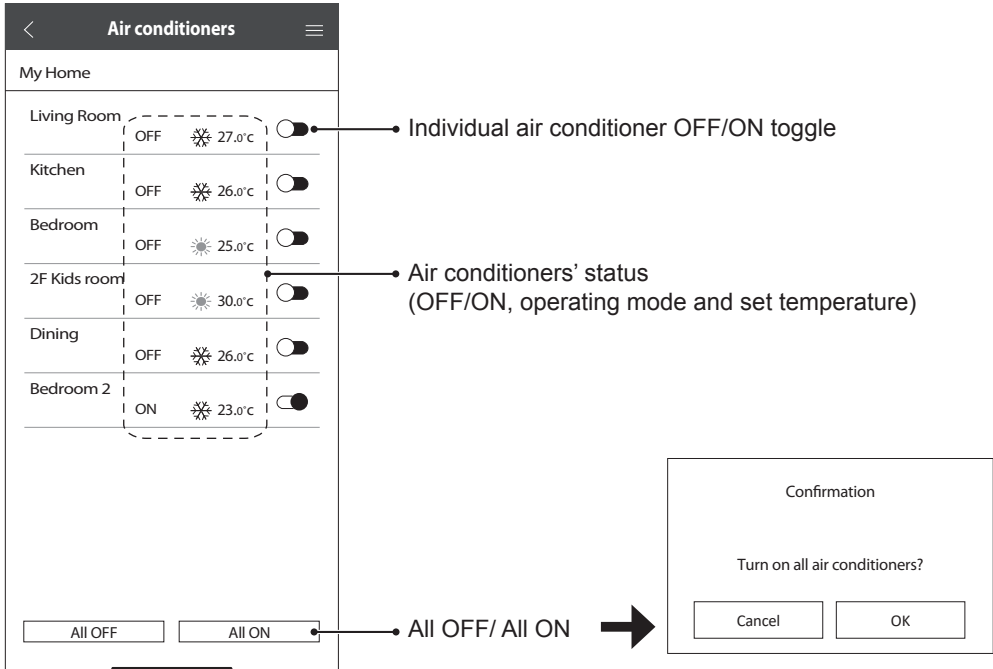

## Advanced settings

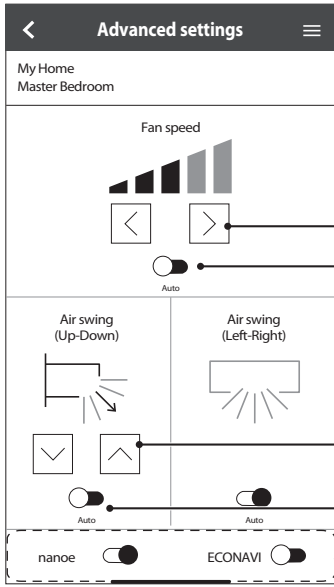

- Setting the fan speed
- Operating mode selection (Subject to model compatibility)
- Auto fan speed OFF/ON toggle
- Setting the air swing position
- Auto air swing OFF/ON toggle
- Additional features OFF/ON toggle

## Operating mode

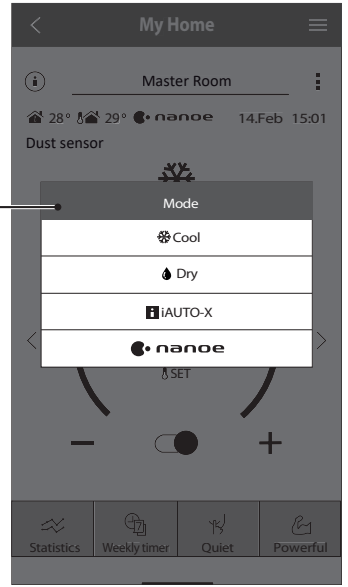

- Operating mode selection (Subject to model compatibility)
- Statistics
- Weekly timer
- Quiet
- Powerful

## Statistics

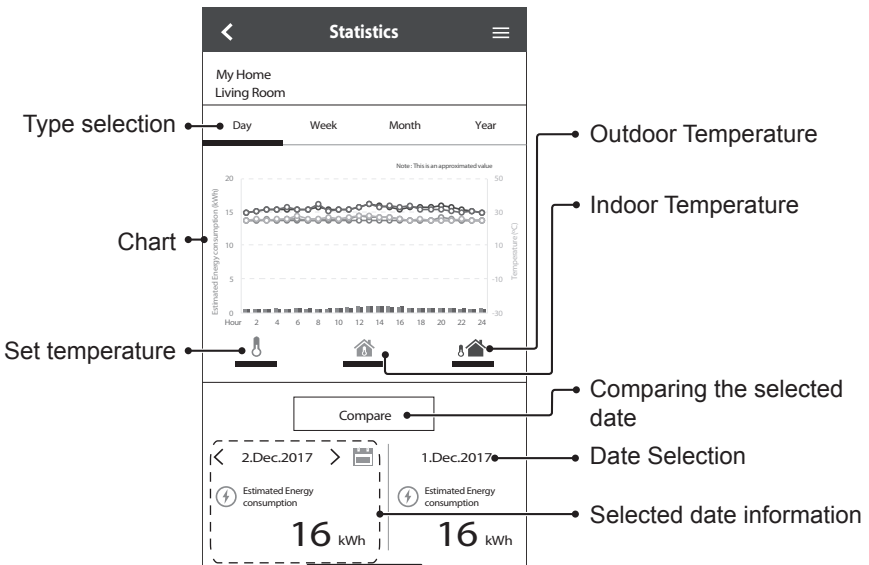

- Type selection
- Chart
- Set temperature
- Outdoor Temperature
- Indoor Temperature
- Comparing the selected date
- Date Selection
- Selected date information

## Note

• Estimated energy consumption may not be supported by certain models.  
 • For Multi-split AC system: energy consumption value displayed is for whole system.

# How to Use

## Weekly Timer

① Tap “Weekly timer” to set the timer schedule.

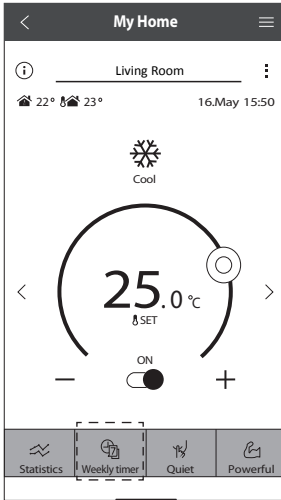

② Tap .

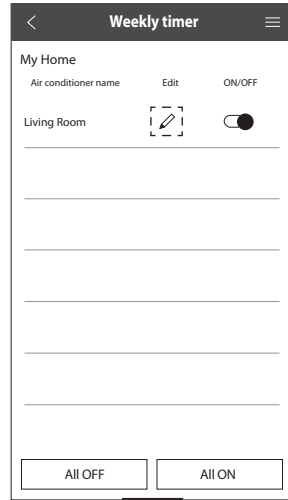

③ Tap  to add a new program. You can set a maximum of six programs for one day.

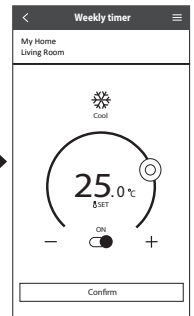
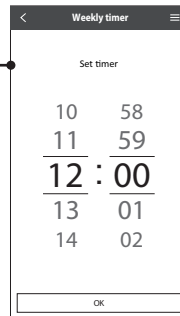
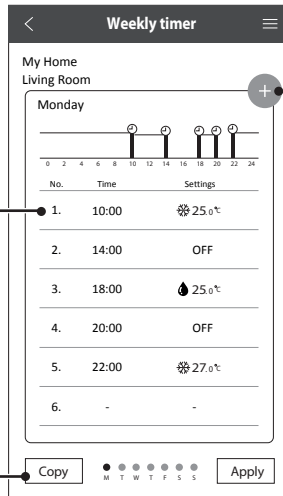
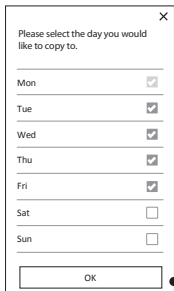
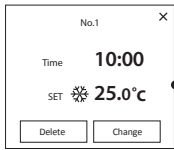

Copy timer



## Main Menu

The main menu allows user to edit the device settings and provides important information.

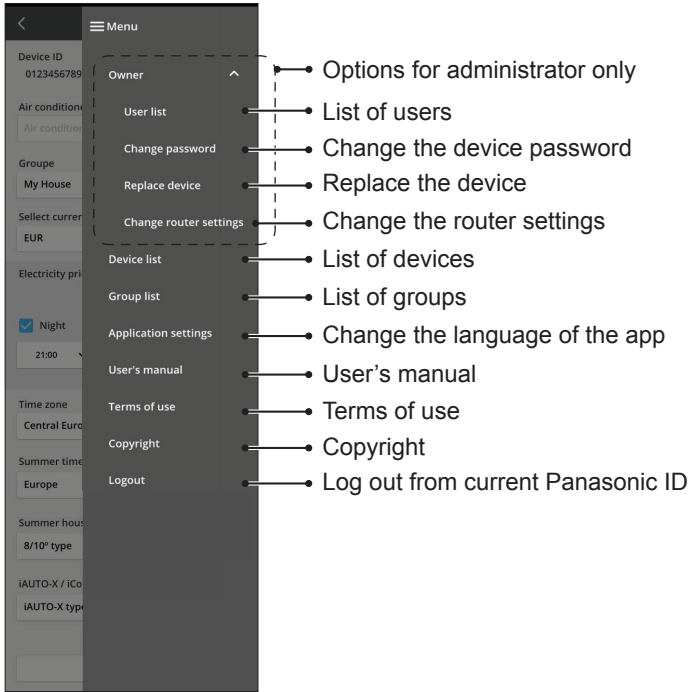

## User List

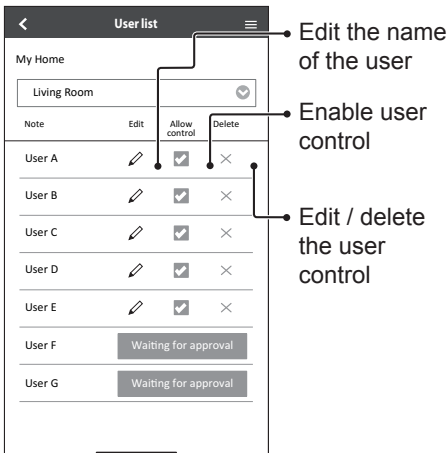

## Change the Device Password

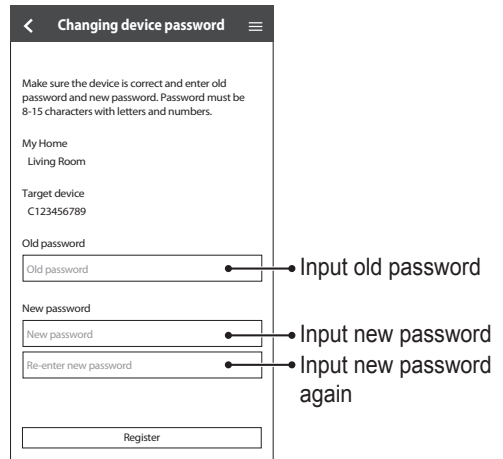

# How to Use

## Replace the Device

- ① Select “Replace device” from the menu.

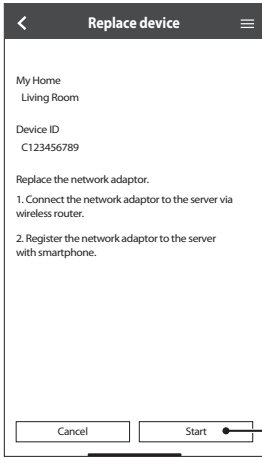

Tap Start

## Change the Router Settings

- ② Select “Change router settings” from the menu.

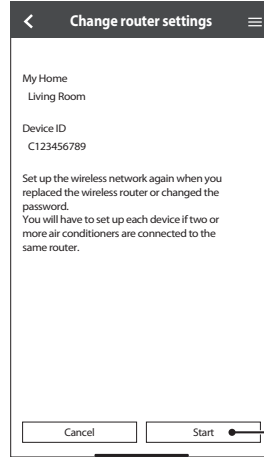

Tap Start

## Device List



Edit the device information and settings

Delete the device

## Group List

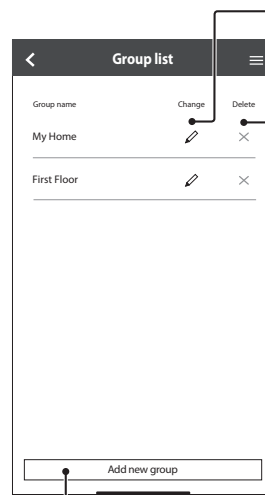

Edit the group name

Delete the group

Add new group





# Network Adaptor & App FAQs

Before calling your local service agent, please review this list. It may save you some time.

## Initial setting

Symptom	Solution
"Panasonic Comfort Cloud" app cannot be installed in smartphone.	Check if the smartphone version is compatible (Android 5.0 and above, or iOS9 and above). There is no guarantee that the app will work well with all versions.
Register additional air conditioner to "Panasonic Comfort Cloud" app.	Follow the steps for the initial air conditioner setup. We recommend that you name each registered air conditioner so that it is easy to differentiate them.
Register additional user to control the Network Adaptor.	Download the "Panasonic Comfort Cloud" app and create a new Panasonic ID. Follow the initial setting. When the air conditioner is registered, input the password set by the first user (owner). The owner needs to approve to complete the registration. For approval, the owner needs to select  , then select "Owner". After that, select "User List" to approve the additional user.

## Connection

Symptom	Solution
Air conditioner and wireless router cannot be connected.	Check that the router's LAN signal reaches the unit, the SSID is not hidden, the MAC address setup is enabled for the unit, and the router's dual band signal is enabled for 2.4 GHz connection. Before setup, ensure that your smartphone is connected to a 2.4 GHz network. Some MESH network router is automatically assigned to 5G signal. In such case, add a dedicated 2.4 GHz router to the existing network.
Unable to connect to Cloud server.	Business network that requires a server login are not supported. The IP address of PCPF and AFUS may be filtered or could have been blocked. Set up a separate Wireless LAN network for IoT products. For router setting, use port: 443; URL: <a href="http://ldcws.pcpf.panasonic.com">ldcws.pcpf.panasonic.com</a>
Wireless signal is disconnected or interrupted.	Your network connection may not be stable. Check the signal strength using these steps: <ul style="list-style-type: none"> <li>• Stop the air conditioner operation, then press the Wireless LAN  button for 5 seconds until "1" appears on the remote control.</li> <li>• Press  until "4" appears.</li> <li>• Press  and the operation stops.</li> <li>• After 5 seconds, the Wireless LAN LED on the indoor unit will show the signal strength. <ul style="list-style-type: none"> <li>Strong: Blink 3 times, followed by an interval</li> <li>Moderate: Blink 2 times, followed by an interval</li> <li>Weak: Blink once, followed by an interval</li> <li>No signal: OFF</li> </ul> </li> <li>• The network connection will automatically stop after 10 minutes. Press the Wireless LAN  button to stop immediately.</li> </ul>
Suspicious or unauthorized access to the unit.	• Reset the air conditioner to manufacturing default condition. For details, refer "Others - To transfer or dispose the air conditioner." in this chapter. Then, set up the network connection again.





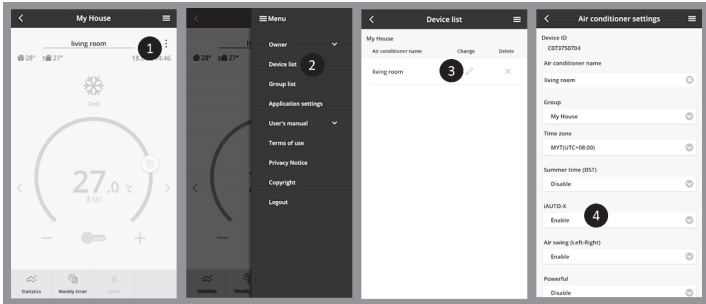

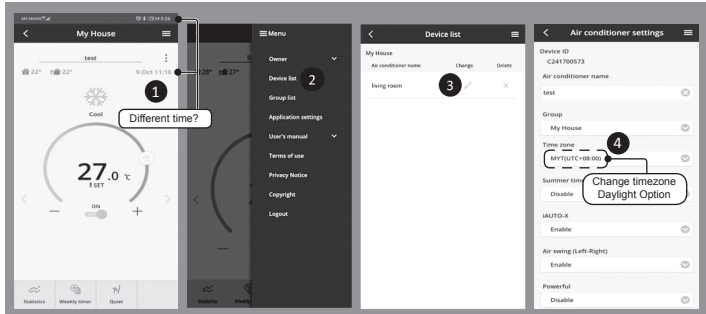
# Network Adaptor & App FAQs

## “Panasonic Comfort Cloud” app

Symptom	Solution
Unable to retrieve user ID	Due to the privacy data protection act, the “Panasonic Comfort Cloud” administrator cannot retrieve your Panasonic ID. Create a new Panasonic ID.
Unable to receive the email link for password rest after selecting “Forgot ID/password”	Your email address may have been input incorrectly. Select “Forgot ID/ Password” again.
Logged off even though “Remember me” is selected.	<ul style="list-style-type: none"> <li>• User disagreed with the privacy notice.</li> <li>• Due to the privacy data protection act, you will be logged off automatically if you do not access the “Panasonic Comfort Cloud” app for 15 day continuously.</li> <li>• The “Panasonic Comfort Cloud” app was closed in your mobile phone. Reopen the “Panasonic Comfort Cloud” app without network connection.</li> <li>• The “Panasonic Comfort Cloud” server is being maintained or updated.</li> <li>• Your Panasonic ID was used to log in on another smartphone. You can only log in one Panasonic ID on one smartphone.</li> <li>• The “Panasonic Comfort Cloud” storage data / cache was cleared. Log in to “Panasonic Comfort Cloud” app again.</li> </ul>
The indoor temperature icon is not displayed.	The indoor temperature icon is only applicable for models with the latest design.
Some product features such as HEAT, iAUTO-X, Air swing (Left-Right) and Powerful are unavailable.	<p>The product features will appear according to each country’s default setting. Select the correct country during User ID registration.</p> <p>The app administrator can enable the product features for each air conditioner in the group as follow:</p> 

Symptom	Solution
The Weekly Timer does not function.	<p>Check if you turned on the Weekly Timer at the “Panasonic Comfort Cloud” app as follow:</p>  <p>Check if there is any conflict between the Weekly Timer and the remote control Timer. The app server and the remote control time may be different. The timer will activate based on the earlier time. Check if the time zone has been set correctly as follow:</p> 

## Others

Symptom	Solution
Replacement of router.	Select  from the “Panasonic Comfort Cloud” app. Select “Owner”, then select “Change router settings”.
Change of smartphone’s model.	Check if the smartphone version is compatible (Android 5.0 and above, or iOS9 and above). Install the “Panasonic Comfort Cloud” app and log in using your Panasonic login ID and password. Follow the steps for the initial connection setup.
Change of control board of the indoor unit.	Change the control board. Then, select  from the “Panasonic Comfort Cloud” app. Select “Owner”, then select “Replace device”. Note that the authorised service dealer shall perform this.
Change of Network Adaptor/Wireless LAN module of indoor unit.	Change the Network Adaptor/Wireless LAN module. Then, select  from the “Panasonic Comfort Cloud” app. Select “Owner”, then select “Change router settings”. Note that the authorised service dealer shall perform this.
To transfer or dispose the air conditioner.	<p>Reset the air conditioner to manufacturing default condition.</p> <ul style="list-style-type: none"> <li>• Check that the Wireless LAN LED on the indoor unit is ON/blinking, then press the Wireless LAN  button for 5 seconds until “1” appears on the remote control.</li> <li>• Press  until “5” appears.</li> <li>• Press  for 3 seconds and the operation stops.</li> <li>• The Wireless LAN LED is OFF and the factory reset is completed.</li> </ul> <p>To unregister the air conditioner from the “Panasonic Comfort Cloud” app, select , then select “Device list” to delete the unit.</p>

# Troubleshooting

The following symptoms do not indicate malfunction.

Symptom	Cause
Wireless LAN LED is ON when the unit is OFF.	<ul style="list-style-type: none"><li>• The unit's wireless LAN connection with the router has been activated.</li></ul>
Wireless LAN LED blinks continuously.	<ul style="list-style-type: none"><li>• The unit's wireless LAN connection with the router is not established. Recheck your connection.</li><li>• If you do not want to use the app, press Wireless LAN  button to turn it off.</li></ul>

## Information



### Declaration of Conformity (DOC)

Hereby, "Panasonic Corporation" declares that this product is in compliance with the essential requirements and other relevant provisions of Directive 2014/53/EU

The full text of the EU declaration of conformity is available at the following internet address:

<http://www.ptc.panasonic.eu/>

Authorized Representative: Panasonic Testing Centre, Panasonic Marketing Europe GmbH, Winsbergring 15, 22525 Hamburg, Germany

Norway: There are usage restrictions within a radius of 20 km from the centre of Ny-Alesund on Svalbard.

**For latest software licensing and copyright information of this product, kindly refer to the latest user manual from our website :**

[https://accsmart.panasonic.com/Manual/Built-In/en/manual\\_en.pdf](https://accsmart.panasonic.com/Manual/Built-In/en/manual_en.pdf)

## **Firmware Update Function**

This product has functionality for connecting to the Panasonic firmware update server over the Internet to automatically update the device firmware to the latest version.

To update the firmware, the device will do check, once per day, whether its firmware is the latest version after power up. And if an update is required, the update is applied and the device restarts automatically. Operations are not possible while the device is being restarted (which takes about 1-5 minutes).

## **Software License Information**

This product incorporates the following software:

- (1) The software developed independently by or for Panasonic Corporation,
- (2) The software owned by third party and licensed to Panasonic Corporation,
- (3) The open source software under the BSD licence and/or equivalent licenses.

The software categorized as of (3) is distributed in the hope that it will be useful, but WITHOUT ANY WARRANTY, without even the implied warranty of MERCHANTABILITY or FITNESS FOR A PARTICULAR PURPOSE.

The following license terms shall be applied to Open-Sourced Components.

### 1. Supplicant license

Copyright (C) 2003-2016, Jouni Malinen <j@w1.fi > and contributors.  
All rights reserved.

This software may be distributed, used, and modified under the terms of BSD license:

Redistribution and use in source and binary forms, with or without modification, are permitted provided that the following conditions are met:

1. Redistributions of source code must retain the above copyright notice, this list of conditions and the following disclaimer.
2. Redistributions in binary form must reproduce the above copyright notice, this list of conditions and the following disclaimer in the documentation and/ or other materials provided with the distribution.
3. Neither the name(s) of the above-listed copyright holder(s) nor the names of its contributors may be used to endorse or promote products derived from this software without specific prior written permission.

THIS SOFTWARE IS PROVIDED BY THE COPYRIGHT HOLDERS AND CONTRIBUTORS AS IS AND ANY EXPRESS OR IMPLIED WARRANTIES, INCLUDING, BUT NOT LIMITED TO, THE IMPLIED WARRANTIES OF MERCHANTABILITY AND FITNESS FOR A PARTICULAR PURPOSE ARE DISCLAIMED. IN NO EVENT SHALL THE COPYRIGHT OWNER OR CONTRIBUTORS BE LIABLE FOR ANY DIRECT, INDIRECT, INCIDENTAL, SPECIAL, EXEMPLARY, OR CONSEQUENTIAL DAMAGES (INCLUDING, BUT NOT LIMITED TO, PROCUREMENT OF SUBSTITUTE GOODS OR SERVICES; LOSS OF USE, DATA, OR PROFITS; OR BUSINESS INTERRUPTION) HOWEVER CAUSED AND ON ANY THEORY OF LIABILITY, WHETHER IN CONTRACT, STRICT LIABILITY, OR TORT (INCLUDING NEGLIGENCE OR OTHERWISE) ARISING IN ANY WAY OUT OF THE USE OF THIS SOFTWARE, EVEN IF ADVISED OF THE POSSIBILITY OF SUCH DAMAGE.

# Adaptateur réseau intégré qui vous permet de contrôler le fonctionnement de votre climatiseur depuis n'importe où.

Nous vous remercions d'avoir porté votre choix sur ce produit Panasonic.

## Table des Matières

Consignes de sécurité .....	24-25
Présentation du système .....	26
Consignes d'utilisation .....	27-40
FAQ sur l'adaptateur réseau et l'application .....	41-43
Dépannage .....	44
Informations .....	44-45

## Consignes de sécurité

Avant d'essayer de contrôler / faire fonctionner ce climatiseur par communication sans fil depuis un lieu éloigné, assurez-vous de vérifier l'installation de l'appareil et son environnement, et méfiez-vous de toute personne se trouvant à proximité.

Pour éviter des blessures corporelles sur vous-même et sur les autres ou des dégâts matériels, respectez les instructions ci-dessous :

Tout dysfonctionnement dû au non-respect des instructions peut occasionner des nuisances ou des dégâts dont la gravité est classée comme décrit ci-après :



### AVERTISSEMENT

Ce symbole signale la présence d'un danger pouvant provoquer des blessures graves ou mortelles.



### ATTENTION

Ce symbole signale la présence d'un danger pouvant provoquer des blessures corporelles ou des dégâts matériels.

Les instructions à respecter sont classées d'après les symboles suivants :



Ce symbole désigne une action INTERDITE.



Ce symbole désigne une action OBLIGATOIRE.



## AVERTISSEMENT

### Adaptateur réseau (activé)



Ne pas utiliser l'unité intérieure à proximité d'un équipement médical ou d'un équipement de contrôle automatique (porte automatique, alarmes filaires, etc.).  
(Les ondes radio émises par l'unité intérieure pourraient interférer avec l'équipement et occasionner un incident dû à un dysfonctionnement)



# Consignes de sécurité



Laissez au moins 15 cm entre vous et l'unité intérieure si vous êtes porteur d'un stimulateur cardiaque.

(Les ondes radio émises par l'unité intérieure pourraient interférer avec le fonctionnement du stimulateur)



## ATTENTION

### Adaptateur réseau (activé)



Vérifier les exigences suivantes à l'avance (à la maison) :

- Insertion correcte de l'alimentation. Assurez-vous qu'il n'y a pas d'accumulation de poussière sur l'alimentation.

(Cela pourrait occasionner un incendie à cause d'une inflammation au niveau du mauvais contact de l'alimentation)

- Vérifiez l'état d'activation du minuteur réglé par une autre personne.

(Une opération de marche-arrêt inattendue pourrait nuire au corps humain, aux animaux domestiques et aux plantes)

- Le climatiseur ne doit présenter aucune anomalie, comme un changement de débit d'air. Veillez à ce qu'aucun objet ne puisse être facilement déplacé en raison du flux d'air soufflant directement sur lui. Les objets tombés ou déplacés peuvent occasionner des risques d'incendie, de blessures, etc.

- À tout moment, utilisez la télécommande intérieure lorsqu'il est possible que des personnes (comme un nourrisson, un enfant, une personne handicapée, une personne âgée ou malade) soient incapables de contrôler elles-mêmes la température et se fient à la configuration prédéfinie du climatiseur.

L'élévation et la baisse de la température dues au fonctionnement à distance peuvent causer de l'inconfort à l'occupant ou aux occupants et/ou perturber leur routine quotidienne.

Les plantes et les animaux sont susceptibles d'être affectés par des ajustements soudains de la température.



Vérifiez les conditions suivantes avant d'utiliser le climatiseur depuis un lieu distant :

- Prévenez la ou les personnes se trouvant à proximité de la zone à climatiser que vous allez contrôler le fonctionnement et les réglages du climatiseur à distance. Ceci afin d'éviter toute possibilité d'effets graves sur la ou les personnes, soit par l'effet de surprise, soit par des changements brusques de température (du confort au froid ou inversement).

(Ceci peut entraîner des changements soudains de la température extérieure ou de la température ambiante qui pourraient nuire au corps humain. Le réglage de la température peut être effectué avec la télécommande)

- Si l'écran principal de l'application Panasonic Comfort Cloud ne reflète pas l'état de fonctionnement, veuillez utiliser la télécommande intérieure pour faire fonctionner le climatiseur.

- Comme l'application utilise la communication réseau, le fonctionnement à distance peut parfois s'avérer impossible en raison de pannes de communication et/ou de réseau (telles que l'indisponibilité du serveur Panasonic Cloud, du serveur des fournisseurs de télécommunications, de la connectivité Wi-Fi, etc.) Dans l'éventualité d'une telle panne, veuillez utiliser la télécommande intérieure pour faire fonctionner le climatiseur.

# Présentation du système

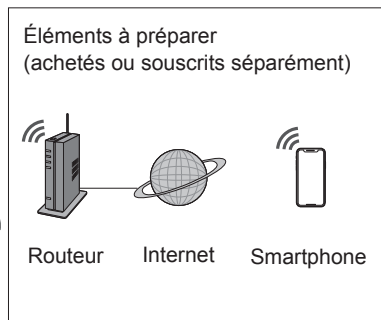
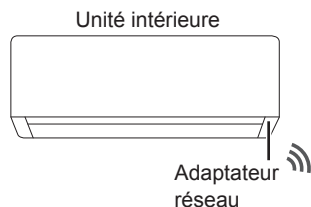

Télécharger depuis le magasin d'applications

Application Panasonic Comfort Cloud (gratuite)

- Cette fonction nécessite l'application d'être installée sur un smartphone Android 5.0 et ultérieur, ou iOS 9 et ultérieur. Toutefois, un fonctionnement correct de l'application n'est pas garanti pour toutes les versions.
- L'adaptateur réseau est spécifiquement conçu en tant que borne pour l'application « Panasonic Comfort Cloud ».
- La couverture réseau LAN sans fil doit atteindre le lieu d'installation de l'unité intérieure.

## Caractéristiques

Adaptateur réseau	Module LAN sans fil (intégré)
Modèle	DNSK-P11
Tension d'entrée	DC 5V (Depuis l'unité de climatisation intérieure)
Consommation de courant	Tx/Rx max. 290/100 mA
Norme LAN sans fil	IEEE 802,11 b/g/n
Plage de fréquences	Bande 2,4 GHz
Chiffrement	WPA2-PSK (TKIP/AES)

## Précautions

- Ne PAS démonter ou modifier l'adaptateur réseau de quelque manière que ce soit.
- Ne PAS retirer cet adaptateur réseau de l'unité intérieure pendant le fonctionnement.
- Les données transmises et reçues par ondes radio peuvent être interceptées et surveillées.

## Puissance maximale des radiofréquences émises dans les bandes de fréquences

Type de système sans fil	Bande de fréquences	PIRE max. (dBm)
WLAN	2412 - 2472 MHz	20 dBm

# Consignes d'utilisation

## Précautions d'utilisation

- Avant d'utiliser le produit, veuillez lire attentivement toutes les précautions d'utilisation fournies dans ce manuel. La Société ne pourra être tenue responsable de toute anomalie ou de tout dommage éventuels résultant d'une mauvaise utilisation par vous ou toute autre personne, à moins qu'une responsabilité juridique ne soit reconnue à l'égard de ces défaillances.

## Mesure de sécurité

- Le réseau local sans fil utilise les ondes radio pour échanger des informations. Il y a donc un risque d'accès non autorisé.
- Initialisez les réglages de l'application sur le produit avant de le mettre au rebut ou de le transférer à une tierce partie.

## Avant de régler la connexion réseau

- Confirmez que le routeur sans fil est correctement connecté au réseau.
- Confirmez que le LAN sans fil du smartphone est activé.
- Vérifiez que votre smartphone et ce produit sont bien connectés sur le même routeur sans fil.

## Installation de l'application

Pour les utilisateurs Android (Android 5.0 et ultérieur)

- Ouvrir  .
- Recherchez l'application « Panasonic Comfort Cloud ».
- Téléchargez-la et installez-la.

Pour les utilisateurs iOS (iOS 9 et ultérieur)

- Ouvrir  .
- Recherchez l'application « Panasonic Comfort Cloud ».
- Téléchargez-la et installez-la.

## Remarque

- L'interface utilisateur de l'application peut se trouver modifier sans préavis en cas de mise à jour.
- L'utilisation de cette application est gratuite. Toutefois, la connexion au réseau et le fonctionnement peuvent engendrer d'autres frais.

## Démarrage de « Panasonic Comfort Cloud »

### Créer un nouvel identifiant Panasonic

Utilisez l'application « Panasonic Comfort Cloud » comme option pour contrôler ce produit.

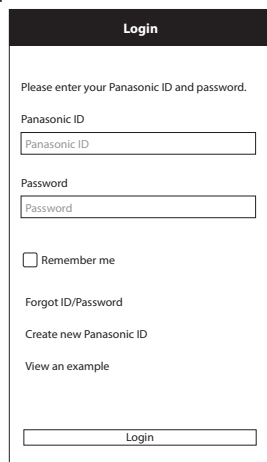

Login

Please enter your Panasonic ID and password.

Panasonic ID

Panasonic ID

Password

Password

Remember me

[Forgot ID/Password](#)

[Create new Panasonic ID](#)

[View an example](#)

Login

- Pour un nouvel utilisateur, sélectionnez « Create new Panasonic ID » pour vous enregistrer.
- Pour un utilisateur enregistré, connectez-vous à l'aide de votre identifiant Panasonic et de votre mot de passe.

# Consignes d'utilisation

## Paramétrage de l'application

### Ajout d'un nouvel appareil

• Avant d'utiliser l'application « Panasonic Comfort Cloud », vous devez enregistrer ce produit.

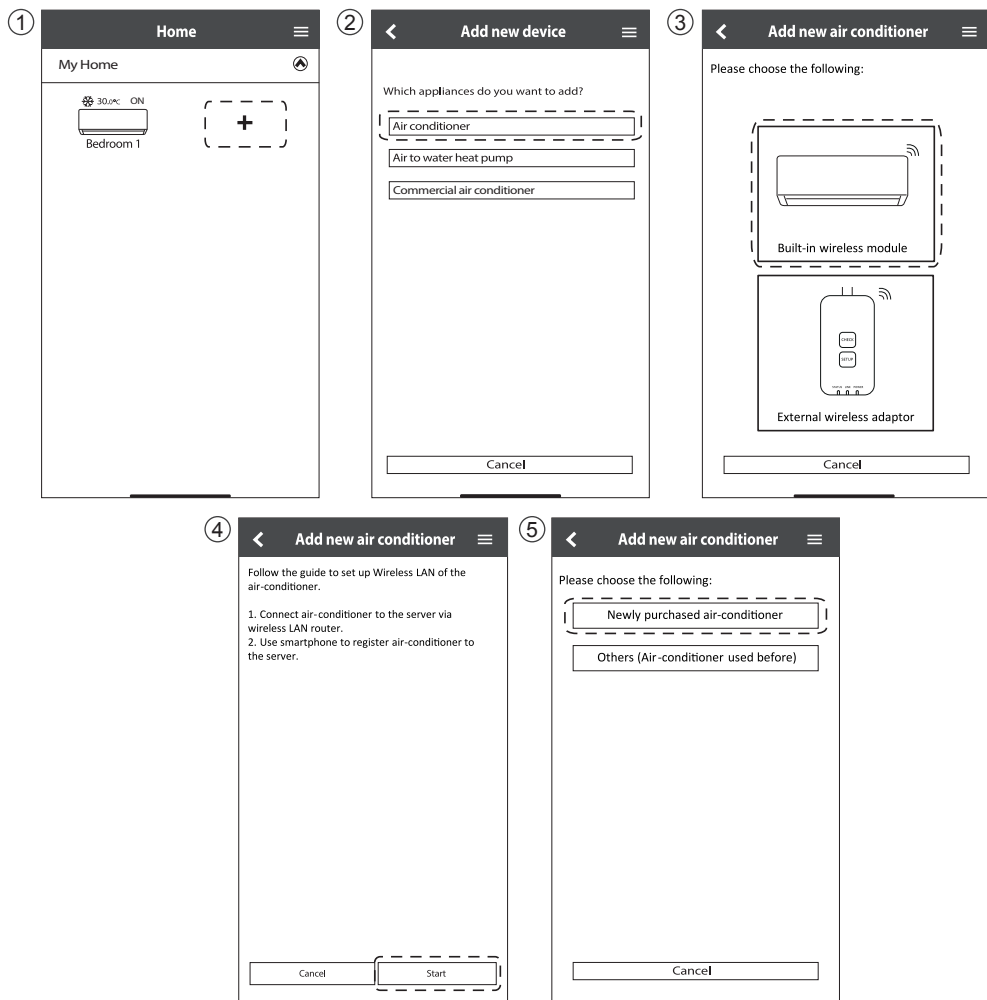

## Paramétrage de la connexion réseau

- Assurez-vous que la LED du LAN sans fil est allumée. Dirigez la télécommande vers le climatiseur et appuyez sur le bouton  du LAN sans fil jusqu'à ce que la LED du LAN sans fil se mette à clignoter.

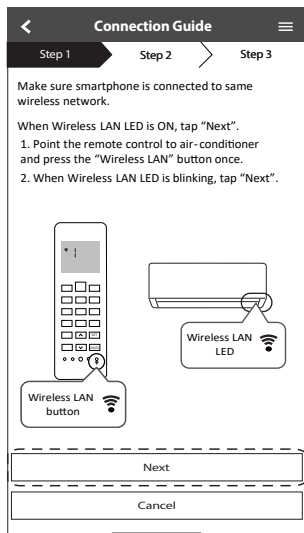

Clignotement rapide	L'unité est en train d'établir la connexion.
Clignotement lent	L'unité ne sécurise pas la connexion.
Pas de clignotement (reste éclairée)	L'unité a établi la connexion.

- La connexion peut être établie avec l'unité même si celle-ci est mise en ARRÊT.

### Remarque

- Si la LED du LAN sans fil clignote en continu et que vous ne souhaitez pas utiliser l'application, appuyez sur le bouton  du LAN sans fil pour mettre l'appareil hors tension.

- Sélectionnez l'état de la LED du LAN sans fil.

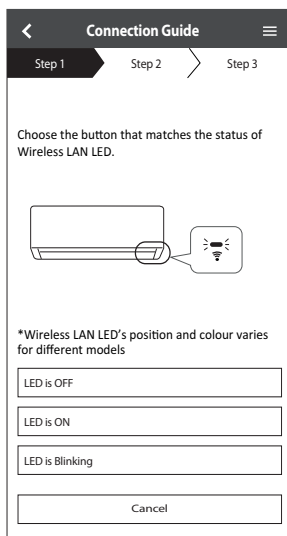

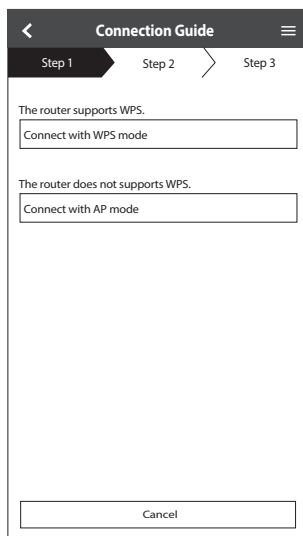

- Sélectionnez le mode de configuration de la connexion souhaitée.



# Consignes d'utilisation

## Connexion réseau avec le mode WPS (méthode 1)

- 1 Appuyez sur le bouton WPS du routeur à connecter au climatiseur.
  - Assurez-vous que la LED du LAN sans fil est allumée. Si la LED du LAN sans fil est éteinte, appuyez sur le bouton  du LAN sans fil pour allumer et activer la connexion du LAN sans fil.
- 2 Assurez-vous que la LED du LAN sans fil est allumée. Maintenez le bouton  du LAN sans fil enfoncé pendant 5 secondes jusqu'à ce que « 1 » s'affiche sur la télécommande. Dirigez la télécommande vers le climatiseur et appuyez sur .

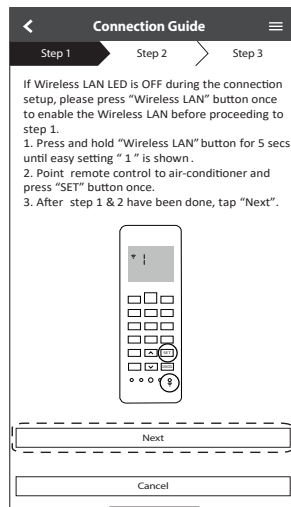
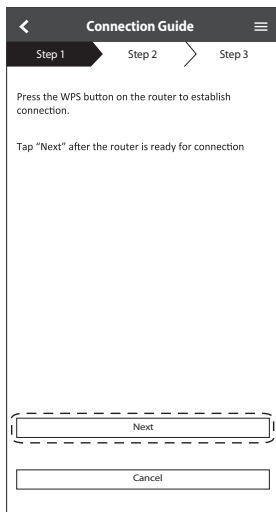

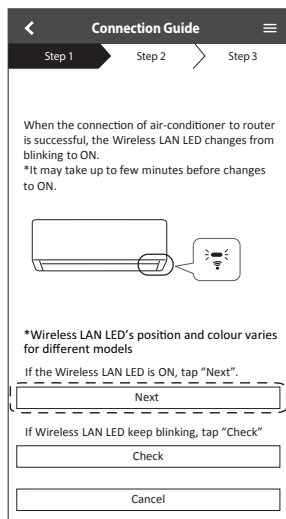

- 3 Lorsque le climatiseur est connecté au routeur, la LED du LAN sans fil arrête de clignoter et s'allume.
- 4 Si la LED du LAN sans fil continue de clignoter, vérifiez la connexion au routeur sans fil.



## Connexion réseau avec le mode AP (méthode 2)

(Pour Android 5.0 et ultérieur et iOS 11 et ultérieur uniquement)

- Assurez-vous que la LED du LAN sans fil est allumée. Maintenez le bouton  du LAN sans fil enfoncé pendant 5 secondes jusqu'à ce que « 1 » s'affiche sur la télécommande. Appuyez sur  jusqu'à ce que « 2 » apparaisse. Dirigez la télécommande vers le climatiseur et appuyez sur . Rejoindre pour établir la connexion au réseau « Panasonic-CS-wirelessAP ».

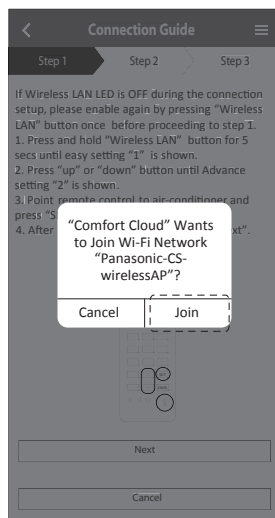
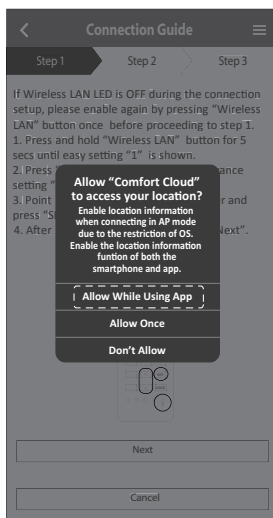
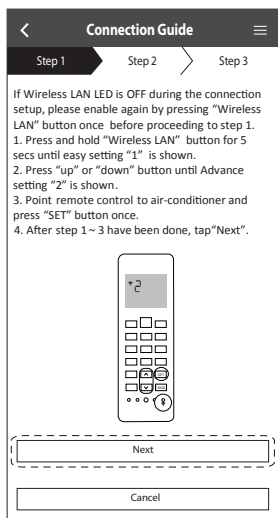

- Entrez le mot de passe du routeur sans fil sélectionné et continuez.

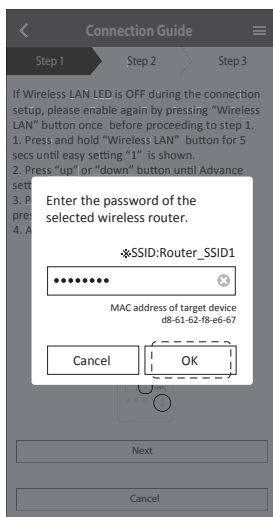

# Consignes d'utilisation

- ③ Lorsque le climatiseur est connecté au routeur, la LED du LAN sans fil arrête de clignoter et s'allume. Lorsque la LED du LAN sans fil s'allume, connectez le smartphone au routeur sans fil pour poursuivre l'installation.
- Si la LED du LAN sans fil continue de clignoter, vérifiez la connexion au routeur sans fil.

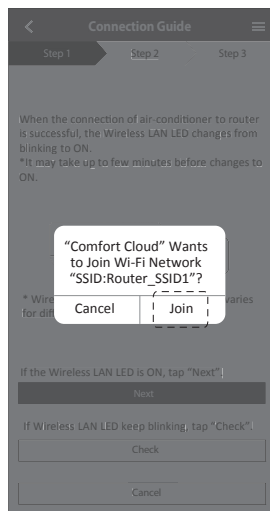
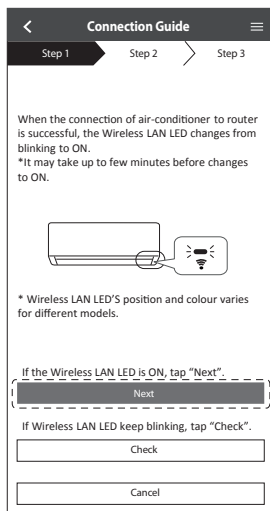



## Sélection du climatiseur et définition du mot de passe

- ① Sélectionnez le modèle pour enregistrer votre climatiseur.

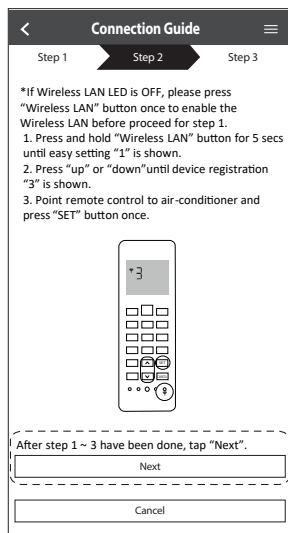
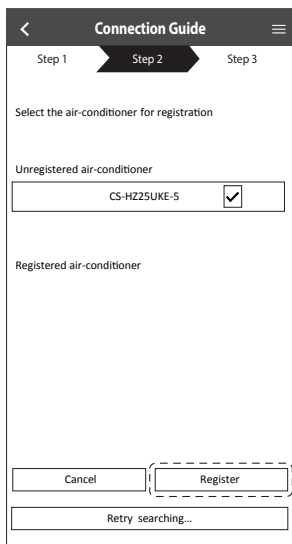

- ② Choisissez un mot de passe pour conclure l'enregistrement. Le mot de passe doit contenir entre 8 et 15 lettres et chiffres combinés.

### Remarque

- Conservez le mot de passe pour un usage ultérieur. Vous pouvez utiliser le même mot de passe quand vous enregistrez d'autres appareils Panasonic.

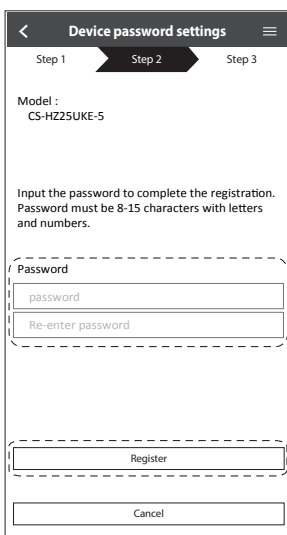

# Consignes d'utilisation

## Enregistrement terminé

- ① Après que l'enregistrement et la connexion soient établis entre l'application et votre climatiseur, choisissez un nom pour identifier plus facilement celui-ci.
  - Après avoir enregistré un nom pour votre climatiseur, vous pouvez utiliser les fonctions de l'application « Panasonic Comfort Cloud ».
- ② Outre le contrôle du fonctionnement, cette application peut surveiller la consommation d'énergie estimée et comparer les différentes périodes en se référant au graphique des statistiques.

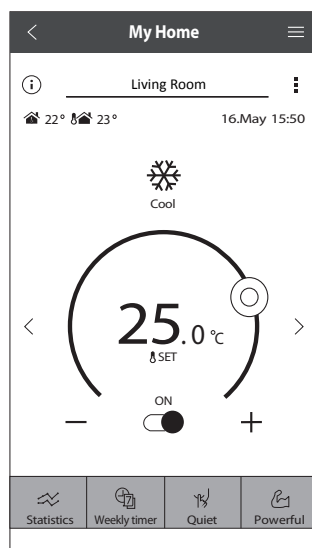
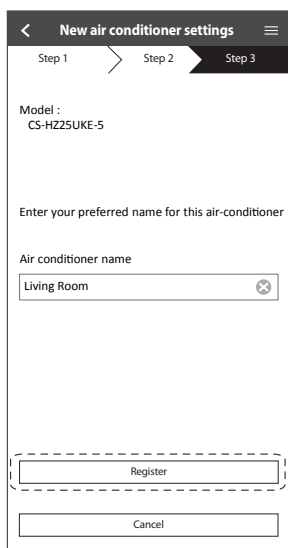

## Remarque

- Vérifiez l'état de la connectivité de l'application avant et pendant l'utilisation. Si l'état ne correspond pas, utilisez la télécommande pour utiliser votre climatiseur.

## Lancer l'application

- 1 Connectez-vous à l'application « Panasonic Comfort Cloud ».
- 2 Sélectionnez le climatiseur que vous souhaitez commander.

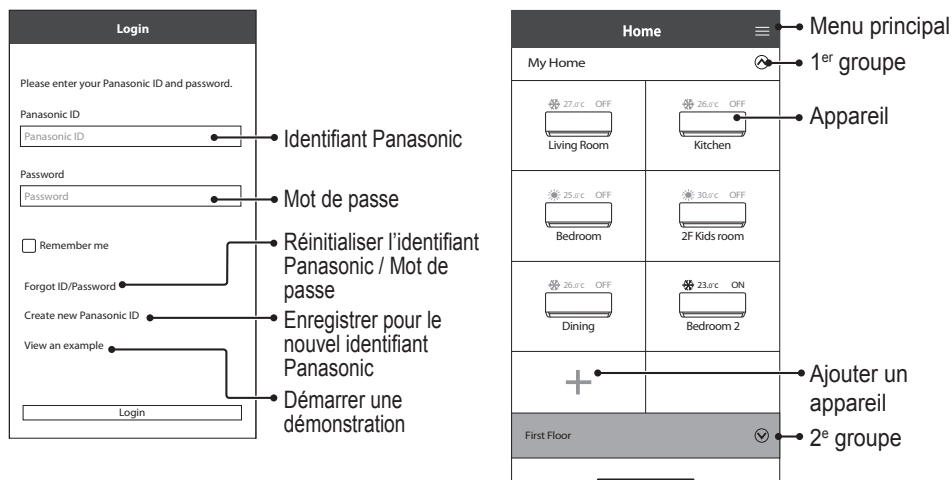

## Écran de l'appareil principal - Réglage du fonctionnement

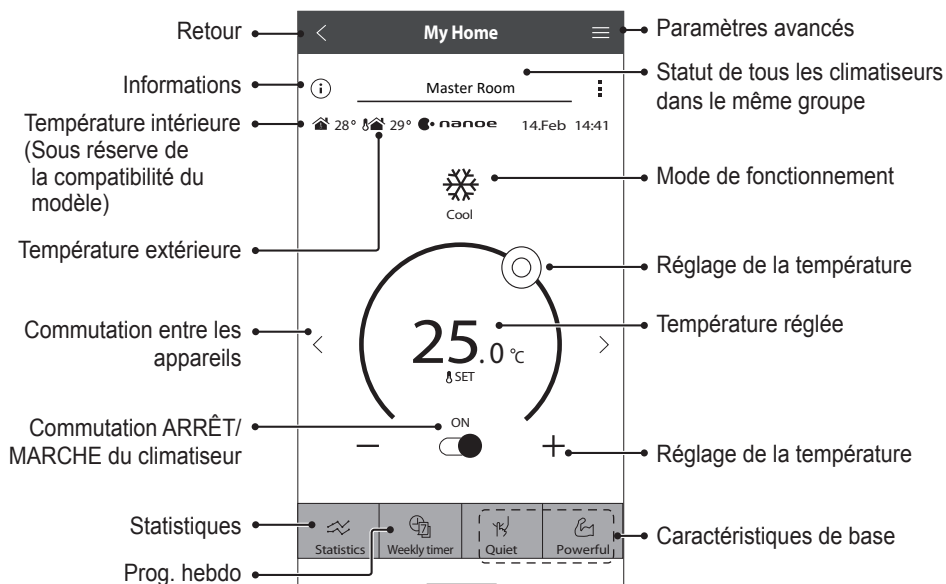

# Consignes d'utilisation

## Informations

The 'Information' screen shows sections for 'Users awaiting your approval', 'Error messages', and 'Notifications'. The 'User approval' screen shows a confirmation dialog for 'User A' with options to 'Do not approve', 'Only allow monitoring air conditioner status', or 'Allow both monitoring and controlling air conditioner'.

Annotations:

- Approbation de l'utilisateur
- Droit de contrôle de l'utilisateur
- Messages d'erreur du climatiseur
- Notifications

## Statut du climatiseur

The 'Air conditioners' screen lists rooms with their AC status (OFF/ON), mode (snowflake/sun), and temperature. At the bottom, there are 'All OFF' and 'All ON' buttons. A confirmation dialog asks 'Turn on all air conditioners?' with 'Cancel' and 'OK' buttons.

Annotations:

- Commutation ARRÊT/MARCHE du climatiseur individuel
- Statut des climatiseurs (ARRÊT/MARCHE, mode de fonctionnement et température réglée)
- Tous à l'ARRÊT/ Tous en MARCHE

## Paramètres avancés

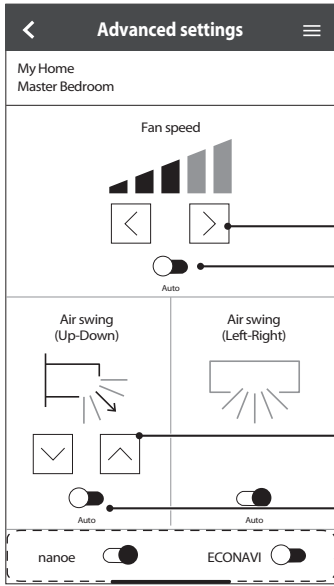

Réglage de la vitesse du ventilateur

Sélection du mode de fonctionnement (Sous réserve de la compatibilité du modèle)

Commutation ARRÊT/MARCHE de vitesse de ventilateur automatique

Réglage de la position d'oscillation de l'air

Commutation ARRÊT/MARCHE d'oscillation de l'air automatique

Commutation ARRÊT/MARCHE des caractéristiques supplémentaires

## Mode de fonctionnement

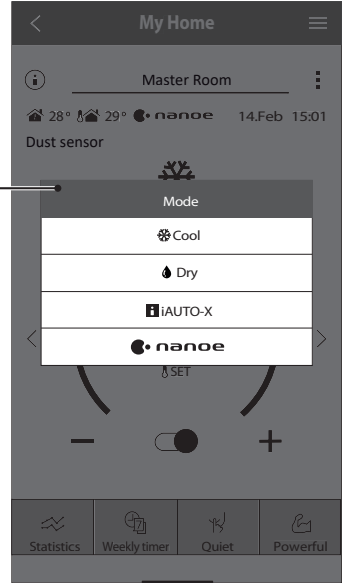

## Statistiques

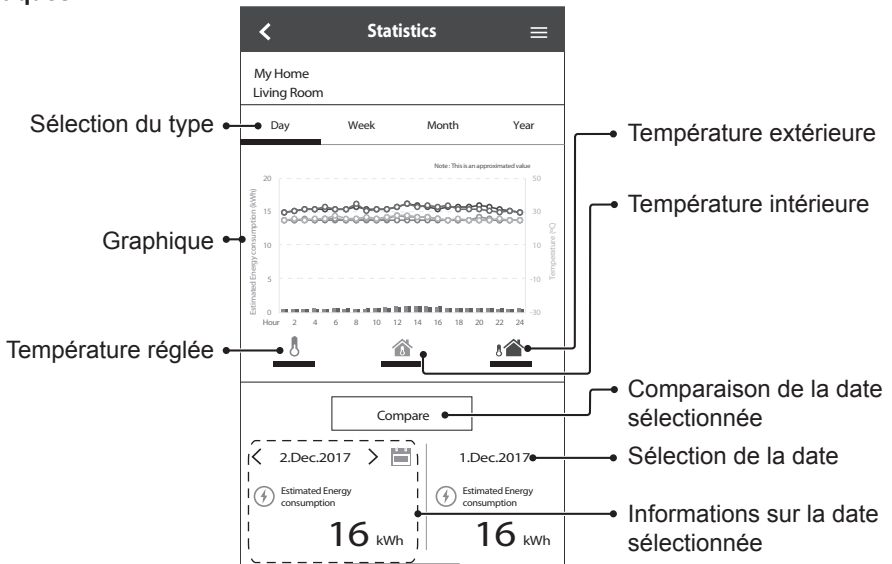

Sélection du type

Graphique

Température réglée

Température extérieure

Température intérieure

Comparaison de la date sélectionnée

Sélection de la date

Informations sur la date sélectionnée

## Remarque

- La consommation d'énergie estimée peut ne pas être prise en charge par certains modèles.
- Pour le système de climatiseur Multisplit : la consommation d'énergie affichée est celle de l'ensemble du système.

# Consignes d'utilisation

## Prog. hebdo

- ① Ouvrez l'onglet « Weekly Timer » pour régler l'emploi du temps.
- ② Ouvrez l'onglet .

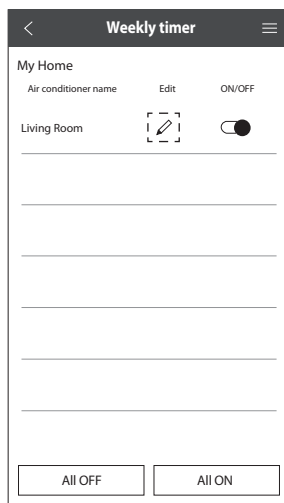
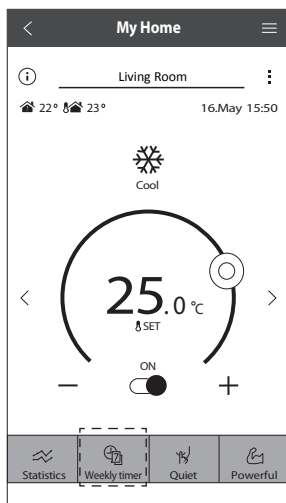

- ③ Ouvrez l'onglet  pour ajouter un nouveau programme. Vous pouvez régler un maximum de six programmes par journée.

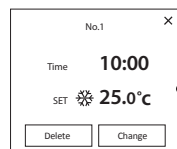

Modifier la minuterie

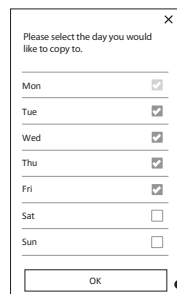

Copier la minuterie

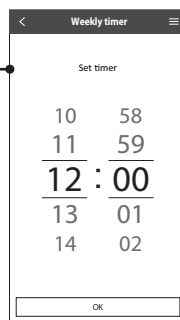
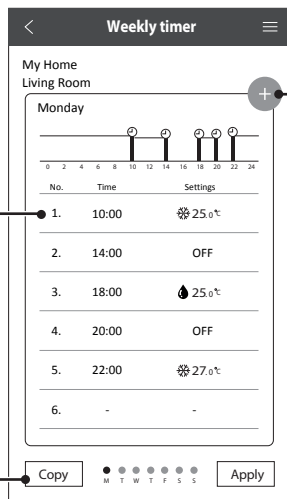

Régler l'heure

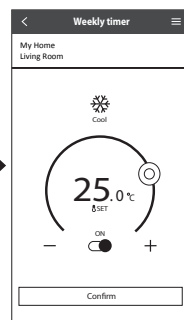

Régler les conditions

## Menu principal

Le menu principal permet à l'utilisateur de modifier les réglages de l'appareil et fournit des informations importantes.

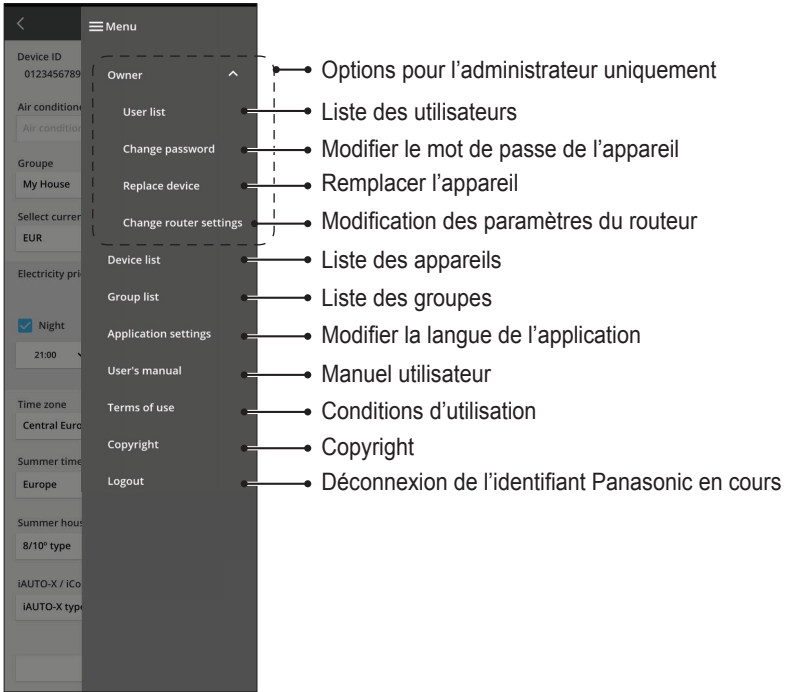

## Liste des utilisateurs



## Modifier le mot de passe de l'appareil

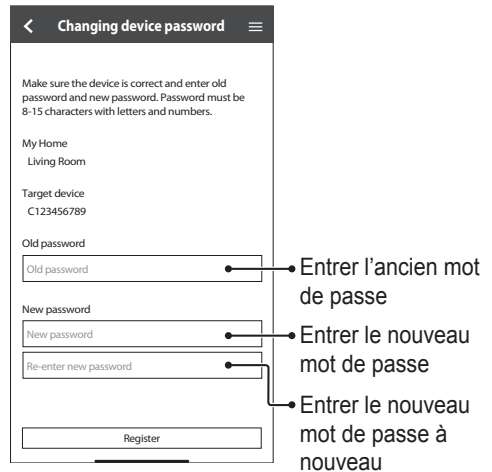

# Consignes d'utilisation

## Remplacer l'appareil

- ① Sélectionner « Replace device » dans le menu.

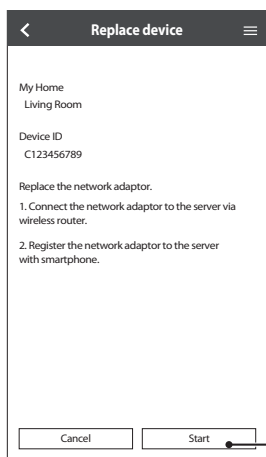

Toucher Démarrer

## Modification des paramètres du routeur

- ② Sélectionner « Change router settings » dans le menu.

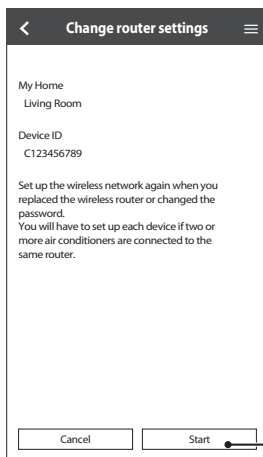

Toucher Démarrer

## Liste des appareils

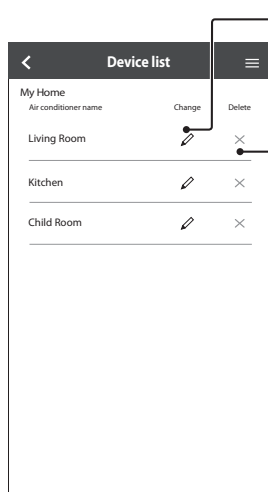

Modifier les informations et les réglages de l'appareil

Supprimer l'appareil

## Liste des groupes

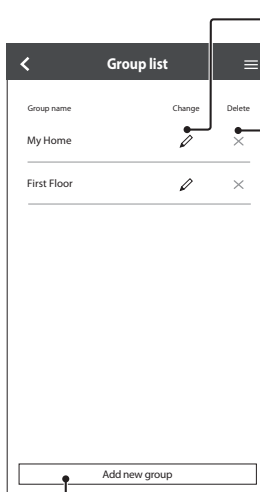

Modifier le nom du groupe

Supprimer le groupe

Ajouter un groupe







# FAQ sur l'adaptateur réseau et l'application

Avant de faire appel à votre technicien local, veuillez examiner cette liste. Cela pourrait vous faire gagner du temps.

## Réglage initial

Phénomène	Solution
Impossible d'installer l'application « Panasonic Comfort Cloud » dans le smartphone.	Vérifiez que la version de votre smartphone est compatible (Android 5.0 et ultérieur, ou iOS 9 et ultérieur). Un fonctionnement correct de l'application avec toutes les versions de système d'exploitation Android n'est pas garanti.
Enregistrement d'un climatiseur supplémentaire dans l'application « Panasonic Comfort Cloud ».	Suivez les étapes suivantes pour la première installation du climatiseur. Nous vous recommandons de nommer chaque climatiseur enregistré pour qu'il soit plus facile de les différencier.
Enregistrement d'un utilisateur supplémentaire pour contrôler l'adaptateur réseau.	Téléchargez l'application « Panasonic Comfort Cloud » et créez un nouvel identifiant Panasonic. Suivez le réglage initial. Quand un climatiseur est enregistré, saisissez le mot de passe choisi par le premier utilisateur (propriétaire). Le propriétaire doit approuver pour finaliser l'enregistrement. Pour l'approbation, le propriétaire doit sélectionner  , puis « Owner ». Ensuite, sélectionnez « User List » pour approuver l'utilisateur supplémentaire.

## Connexion

Phénomène	Solution
Impossible de connecter le climatiseur et le routeur sans fil.	Assurez-vous que le signal LAN du routeur atteint l'unité, que le SSID n'est pas masqué, que la configuration de l'adresse MAC est activée pour l'unité et que le signal de la double bande du routeur est activé pour la connexion 2,4 GHz. Avant l'installation, assurez-vous que votre smartphone est connecté à un réseau de 2,4 GHz. Certains routeurs du réseau MESH sont automatiquement attribués au signal 5G. Dans ce cas, ajoutez un routeur dédié de 2,4 GHz au réseau existant.
Impossible de se connecter au serveur Cloud.	Les réseaux professionnels nécessitant une connexion à un serveur ne sont pas pris en charge. L'adresse IP du PCPF et de l'AFUS peut être filtrée ou peut avoir été bloquée. Mettez en place un réseau LAN sans fil distinct pour les produits de l'IdO. Pour le réglage du routeur, utilisez le port : 443 ; URL : <a href="http://Idcws.pcpf.panasonic.com">Idcws.pcpf.panasonic.com</a>
Le signal sans fil est déconnecté ou interrompu.	Il se peut que votre connexion réseau ne soit pas stable. Vérifiez la puissance du signal via les étapes suivantes : <ul style="list-style-type: none"><li>• Interrompez l'utilisation du climatiseur, puis maintenez le bouton  du LAN sans fil enfoncé pendant 5 secondes jusqu'à ce que « 1 » s'affiche sur la télécommande.</li><li>• Appuyez sur  jusqu'à ce que « 4 » apparaisse.</li><li>• Appuyez sur  et le fonctionnement s'arrête.</li><li>• Après 5 secondes, la LED du LAN sans fil sur l'unité intérieure affichera la puissance du signal.<ul style="list-style-type: none"><li>Fort : Clignote 3 fois avec un intervalle</li><li>Modéré : Clignote 2 fois avec un intervalle</li><li>Faible : Clignote une fois avec un intervalle</li></ul></li><li>Aucun signal : ARRÊT</li><li>• La connexion réseau s'arrêtera automatiquement après 10 minutes. Appuyez sur le bouton  du LAN sans fil pour arrêter immédiatement.</li></ul>
Accès non autorisé ou suspect à l'unité.	• Réinitialisez l'unité de climatisation aux réglages par défaut d'usine. Pour plus de détails, référez-vous à « Autres - Transfert ou élimination du climatiseur » dans ce chapitre. Puis, réglez la connexion réseau à nouveau.





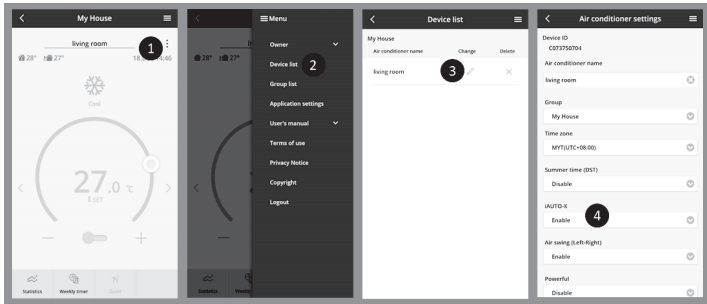

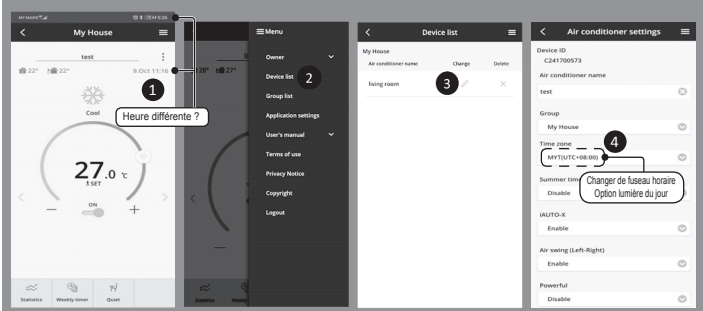
# FAQ sur l'adaptateur réseau et l'application

## Application « Panasonic Comfort Cloud »

Phénomène	Solution
<p>Impossibilité de récupérer l'identifiant utilisateur</p>	<p>En raison de la loi sur la protection des données personnelles, l'administrateur du « Panasonic Comfort Cloud » ne peut pas récupérer votre identifiant Panasonic. Créez un nouvel identifiant Panasonic.</p>
<p>Impossibilité de recevoir le lien par e-mail pour la réinitialisation du mot de passe après avoir sélectionné « Forgot ID/password »</p>	<p>Votre adresse e-mail a peut-être été mal saisie. Sélectionnez à nouveau « Forgot ID/Password ».</p>
<p>Déconnexion malgré la sélection de l'option « Remember me ».</p>	<ul style="list-style-type: none"> <li>• L'utilisateur n'a pas accepté la déclaration de confidentialité.</li> <li>• En raison de la loi sur la protection des données personnelles, vous serez automatiquement déconnecté si vous n'accédez pas à l'application « Panasonic Comfort Cloud » pendant 15 jours sans interruption.</li> <li>• L'application « Panasonic Comfort Cloud » a été fermée dans votre téléphone mobile. Ouvrez à nouveau l'application « Panasonic Comfort Cloud » sans connexion réseau.</li> <li>• Le serveur « Panasonic Comfort Cloud » est en cours de maintenance ou de mise à jour.</li> <li>• Votre identifiant Panasonic a été utilisé pour une connexion sur un autre smartphone. Vous ne pouvez vous connecter qu'avec un seul identifiant Panasonic sur un seul smartphone.</li> <li>• Les données de stockage / de cache de « Panasonic Comfort Cloud » ont été effacées.</li> </ul> <p>Connectez-vous à nouveau à l'application « Panasonic Comfort Cloud ».</p>
<p>L'icône de température intérieure ne s'affiche pas.</p>	<p>L'icône de température intérieure n'est applicable que pour les modèles les plus récents.</p>
<p>Certaines fonctions du produit telles que CHAUFFAGE, iAUTO-X, Oscillation de l'air (gauche-droite) et Turbo sont indisponibles.</p>	<p>Les fonctions du produit apparaîtront en fonction des réglages par défaut de chaque pays. Sélectionnez le pays approprié au cours de l'enregistrement de l'identifiant utilisateur. L'administrateur de l'application peuvent activer les fonctions du produit pour chaque climatiseur du groupe, comme suit :</p> 

Phénomène	Solution
<p>La Prog. hebdo ne fonctionne pas.</p>	<p>Vérifiez si vous avez activé la Prog. hebdo dans l'application « Panasonic Comfort Cloud » comme suit :</p>  <p>Vérifiez s'il existe un conflit quelconque entre la Prog. hebdo et la minuterie de la télécommande. L'heure du serveur et celle de la télécommande sont peut-être différentes. La minuterie sera activée sur la base de l'heure la plus proche. Vérifiez si le fuseau horaire a été correctement réglé, comme suit :</p> 

## Autres

Phénomène	Solution
Remplacement du routeur.	Sélectionnez  depuis l'application « Panasonic Comfort Cloud ». Sélectionnez « Owner » et sélectionnez « Change router settings ».
Changement du modèle de smartphone.	Vérifiez que la version de votre smartphone est compatible (Android 5.0 et ultérieur, ou iOS 9 et ultérieur). Installez l'application « Panasonic Comfort Cloud » et connectez-vous à l'aide de votre identifiant de connexion Panasonic et de votre mot de passe. Suivez les étapes suivantes pour la première connexion.
Changement de la carte de commande de l'unité intérieure.	Modifiez la carte de commande. Puis, sélectionnez  depuis l'application « Panasonic Comfort Cloud ». Sélectionnez « Owner », puis sélectionnez « Replace device ». Veuillez noter qu'un service après-vente agréé peut réaliser cette opération.
Modification du module Adaptateur réseau / LAN sans fil de l'unité intérieure.	Modifiez le module Adaptateur réseau / LAN sans fil. Puis, sélectionnez  depuis l'application « Panasonic Comfort Cloud ». Sélectionnez « Owner » et sélectionnez « Change router settings ». Veuillez noter qu'un service après-vente agréé peut réaliser cette opération.
Transfert ou élimination du climatiseur.	<p>Réinitialisez l'unité de climatisation aux réglages par défaut d'usine.</p> <ul style="list-style-type: none"> <li>• Vérifiez que la LED du LAN sans fil de l'unité intérieure est allumé / clignote et appuyez sur le bouton  du LAN sans fil pendant 5 secondes jusqu'à ce que « 1 » apparaisse.</li> <li>• Appuyez sur  jusqu'à ce que « 5 » apparaisse.</li> <li>• Appuyez sur le bouton  pendant 3 secondes et le fonctionnement s'arrête.</li> <li>• La LED du LAN sans fil est éteinte et les réglages usine sont rétablis.</li> </ul> <p>Pour supprimer l'unité de climatisation de l'application « Panasonic Comfort Cloud », sélectionnez le  et choisissez « Device list » pour supprimer l'unité définie.</p>

# Dépannage

Les phénomènes suivants ne correspondent pas à un dysfonctionnement.

Phénomène	Cause
La LED du LAN sans fil est allumé alors que l'unité est arrêtée.	<ul style="list-style-type: none"><li>• La connexion LAN sans fil de l'unité avec le routeur est activée.</li></ul>
La LED du LAN sans fil clignote en continu.	<ul style="list-style-type: none"><li>• La connexion LAN sans fil de l'unité avec le routeur n'est pas établie. Vérifiez à nouveau votre connexion.</li><li>• Si vous ne souhaitez pas utiliser l'application, appuyez sur le bouton  LAN sans fil pour mettre l'appareil hors tension.</li></ul>

## Informations

### Déclaration de conformité (DdC)



Par les présentes, « Panasonic Corporation » déclare que ce produit est conforme aux exigences fondamentales et autres dispositions pertinentes de la Directive 2014/53/UE

Le texte intégral de la déclaration de conformité UE est disponible à l'adresse Internet suivante : <http://www.ptc.panasonic.eu/>

Représentant autorisé : Panasonic Testing Centre, Panasonic Marketing Europe GmbH, Winsbergring 15, 22525 Hambourg, Allemagne

Norvège : Des restrictions d'utilisation existent dans un rayon de 20 km autour du centre de Ny-Alesund, dans le Svalbard.

# Informations

**Pour les dernières informations sur la licence et le copyright du logiciel de ce produit, veuillez vous reporter au dernier mode d'emploi disponible sur notre site Web :**

<https://accsmart.panasonic.com/Manual/Built-In/en/manual.en.pdf>

## Fonction de mise à jour du micrologiciel

Ce produit est doté d'une fonction lui permettant de se connecter au serveur de mise à jour du micrologiciel Panasonic via Internet pour effectuer automatiquement la mise à jour vers la dernière version.

Pour mettre le micrologiciel à jour, l'appareil contrôle une fois par jour, à son démarrage, s'il dispose bien de la dernière version du micrologiciel. Et si une mise à jour est requise, celle-ci est appliquée et l'appareil redémarre automatiquement. Les opérations sont impossibles pendant le redémarrage de l'appareil (qui prend entre 1 et 5 minutes).

## Informations sur la licence du logiciel

Ce produit intègre le logiciel suivant :

- (1) Le logiciel développé indépendamment par ou pour Panasonic Corporation,
- (2) Le logiciel détenu par un tiers et sous licence de Panasonic Corporation,
- (3) Le logiciel open source sous licence BSD et/ou licences équivalentes.

Le logiciel de catégorie (3) est distribué dans l'espoir qu'il sera utile, mais SANS AUCUNE GARANTIE, sans même la garantie implicite de QUALITÉ MARCHANDE ou d'ADAPTATION À UN USAGE PARTICULIER.

Les conditions de licence suivantes seront appliquées aux composants open source.

### 1. Licence de fournisseur

Copyright (C) 2003-2016, Jouni Malinen <j@w1.fi > et ses contributeurs.

Tous droits réservés.

Ce logiciel peut être distribué, utilisé et modifié sous les termes de la licence BSD :

La redistribution et l'utilisation sous forme source et binaire, avec ou sans modification, sont autorisées sous réserve que les conditions suivantes soient remplies :

1. Les redistributions de code source doivent conserver l'avis de copyright ci-dessus, cette liste de conditions et l'avertissement suivant.
2. Les redistributions sous forme binaire doivent reproduire l'avis de droit d'auteur ci-dessus, cette liste de conditions et la clause de non-responsabilité suivante dans la documentation et/ou les autres documents fournis avec la distribution.
3. Ni le(s) nom(s) du(des) titulaire(s) des droits d'auteur susmentionnés ni les noms de ses contributeurs ne peuvent être utilisés pour endosser ou promouvoir des produits dérivés de ce logiciel sans autorisation écrite préalable spécifique.

CE LOGICIEL EST FOURNI PAR LES DÉTENTEURS DES DROITS D'AUTEUR ET LES CONTRIBUTEURS TEL QUEL ET TOUTE GARANTIE EXPRESSE OU IMPLICITE, Y COMPRIS, SANS S'Y LIMITER, LES GARANTIES IMPLICITES DE QUALITÉ MARCHANDE ET D'ADAPTATION À UN USAGE PARTICULIER SONT REJETÉES. EN AUCUN CAS LE PROPRIÉTAIRE DES DROITS D'AUTEUR OU LES CONTRIBUTEURS NE SERONT TENUS RESPONSABLES DES DOMMAGES DIRECTS, INDIRECTS, ACCESSOIRES, SPÉCIAUX, EXEMPLAIRES OU CONSÉCUTIFS (Y COMPRIS, SANS S'Y LIMITER, L'ACHAT DE BIENS OU DE SERVICES DE REMPLACEMENT, LA PERTE D'UTILISATION, DE DONNÉES OU DE PROFITS, OU L'INTERRUPTION DES ACTIVITÉS), QUELLE QU'EN SOIT LA CAUSE, ET SELON TOUTE THÉORIE DE RESPONSABILITÉ, CONTRACTUELLE OU OBJECTIVE, OU DE RESPONSABILITÉ CIVILE (NÉGLIGENCE OU AUTRE) DÉCOULANT DE QUELQUE FAÇON DE L'UTILISATION DE CE LOGICIEL, MÊME SI LA POSSIBILITÉ DE TELS DOMMAGES A FAIT L'OBJET D'UN AVIS.

# Adaptador de red integrado que le permite controlar el funcionamiento de la unidad de aire acondicionado desde cualquier lugar.

Muchas gracias por elegir este producto Panasonic.

## Contenido

Precauciones de seguridad .....	46-47
Vista general del sistema .....	48
Forma de uso .....	49-62
Adaptador de red y preguntas sobre la aplicación .....	63-65
Localización de averías .....	66
Información .....	66-67

## Precauciones de seguridad

Antes de que intente controlar / operar este producto de aire acondicionado a través de la comunicación inalámbrica desde un lugar remoto, asegúrese de que la instalación del aparato y su área circundante sea verificada, y tenga cuidado con cualquier persona que se encuentre en las cercanías.

Para evitar lesiones personales, lesiones a terceros, o daños materiales, cumpla lo siguiente:

El uso incorrecto por no seguir las instrucciones puede causar daños o averías; su gravedad se clasifica con las indicaciones siguientes:

 <b>ADVERTENCIA</b>	Esta indicación advierte del posible peligro de muerte o de daños graves.
---	---

 <b>PRECAUCIÓN</b>	Esta indicación advierte de los posibles daños o desperfectos materiales.
--	---

Las instrucciones que deben seguirse están clasificadas mediante los siguientes símbolos:



Este símbolo denota una acción que está PROHIBIDA.



Este símbolo denota una acción que es OBLIGATORIA.



## ADVERTENCIA

### Adaptador de red (activado)



No utilice la unidad interna cerca de equipos médicos ni equipos de control automático (puertas automáticas, alarmas de incendios, etc.).

(Es posible que las ondas de radio de la unidad interna interfieran con los equipos y provoquen fallos por averías)

# Precauciones de seguridad



Sepárese un mínimo de 15 cm de la unidad interna si es portador de un marcapasos cardíaco.

(Es posible que las ondas de radio de la unidad interna interfieran con el funcionamiento del marcapasos)



## PRECAUCIÓN

### Adaptador de red (activado)



Compruebe los siguientes requisitos por adelantado (En la unidad doméstica):

- Inserte la fuente de alimentación directamente. Compruebe que no hay acumulación de polvo en la fuente de alimentación.  
(ya que podría provocar un incendio si se prende un contacto débil de la fuente de alimentación)
- Compruebe el estado de la activación del temporizador si lo definió otra persona. (Si el funcionamiento se detiene inesperadamente, las personas, animales o plantas pueden sufrir lesiones)
- El aparato de aire acondicionado no debe presentar ninguna anomalía, como por ejemplo, un cambio en el flujo de aire. Asegúrese de que no haya ningún objeto que pueda desplazarse fácilmente debido al flujo de aire que sopla directamente sobre él. Los objetos caídos o movidos pueden causar peligros como incendios, lesiones, etc.
- Utilice en todo momento el mando a distancia interno cuando exista la posibilidad de que una o varias personas (como bebés, niños, personas discapacitadas, ancianos o enfermos) sean incapaces de controlar la temperatura por sí mismas y dependan de la configuración preestablecida del aire acondicionado.

El aumento y la disminución de la temperatura debido a la operación remota podría causar incomodidad al/a los ocupante(s) y/o interrumpir su rutina diaria. La(s) planta(s) y el/los animal(es) pueden verse afectados por ajustes repentinos de temperatura.



Verifique los siguientes requisitos antes de operar el aparato de aire acondicionado desde un lugar remoto:

- Informe a la(s) persona(s) que se encuentra(n) en las cercanías del área que está siendo climatizada que usted controlará el funcionamiento y los ajustes del aparato de aire acondicionado de forma remota. Esto es para evitar la posibilidad de que se produzcan efectos graves en la(s) persona(s), ya sea por ser tomada(s) por sorpresa o debido a cambios bruscos de temperatura (de la comodidad al frío o viceversa). (Esto podría provocar lesiones debido a cambios repentinos de la temperatura exterior y la temperatura ambiente. Se puede ajustar la temperatura con un mando a distancia)
  - Si la pantalla principal de Panasonic Comfort Cloud APP no muestra el estado de la operación, utilice el mando a distancia interno para hacer funcionar el aire acondicionado.
- Como la aplicación utiliza la comunicación de red, puede haber ocasiones en las que el funcionamiento remoto no sea posible debido a fallos de comunicación y/o de red (tales como el tiempo de inactividad del servidor Panasonic Cloud, el tiempo de inactividad del servidor de los proveedores de telecomunicaciones, la conectividad WIFI, etc.). En caso de tales fallos, utilice el mando a distancia interno para hacer funcionar el aire acondicionado.

# Vista general del sistema

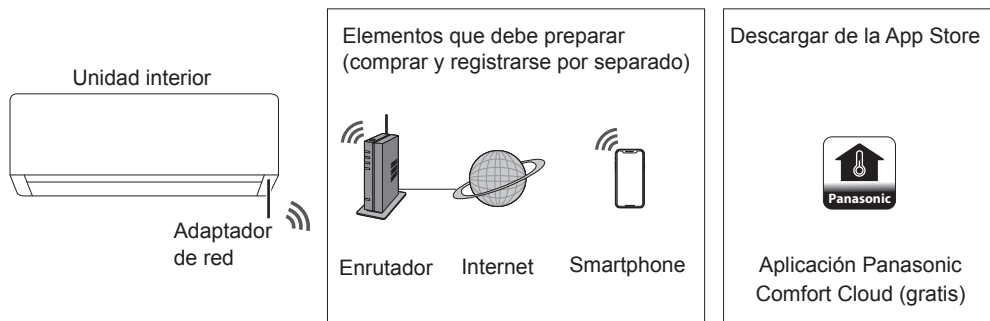

- Esta característica requiere la aplicación para funcionar con un smartphone con Android 5.0 y superior o iOS 9 y superior. Sin embargo, no hay garantías de que la aplicación funcione correctamente con todas las versiones.
- El adaptador de red está diseñado específicamente como un terminal para la aplicación "Panasonic Comfort Cloud".
- La cobertura de red LAN inalámbrica debe llegar al lugar de instalación de la unidad interior.

## Especificación

Adaptador de red	Módulo LAN inalámbrico (integrado)
Modelo	DNSK-P11
Voltaje de entrada	5 V CC (desde la unidad interna del aire acondicionado)
Consumo actual	Tx/Rx máx. 290/100 mA
LAN inalámbrica estándar	Instituto de Ingeniería Eléctrica y Electrónica (IEEE) 802,11 b/g/n
Rango de frecuencia	banda de 2,4 GHz
Cifrado	WPA2-PSK (TKIP/AES)

## Precauciones

- NO desmonte ni modifique este adaptador de red de ninguna manera.
- NO retire este adaptador de red de la unidad interior durante el funcionamiento.
- Es posible que los datos que se transmiten y reciben mediante ondas de radio se intercepten y monitoricen.

## Máxima potencia de radiofrecuencia transmitida en las bandas de frecuencia

Tipo de red inalámbrica	Banda de frecuencia	Máx. potencia isotrópica radiada equivalente (EIRP) (dBm)
WLAN	de 2412 a 2472 MHz	20 dBm



# Forma de uso

## Precauciones de uso

- Antes de usar el producto, asegúrese de leer todas las precauciones de este manual. La Empresa no se responsabiliza de ningún defecto o daño incurrido por el uso de este producto que ocurran debido a un uso incorrecto por parte de usted o de un tercero, a menos que la responsabilidad legal sea reconocida, en lo que respecta a fallas.

## Medida de seguridad

- La LAN inalámbrica utiliza ondas de radio para intercambiar información. Por lo tanto, hay un riesgo de acceso no autorizado.
- Inicializar los ajustes de la aplicación en el producto antes de su eliminación o transferencia a un tercero.

## Antes de la configuración de la conexión de red

- Confirme que el router está conectado a la red correctamente.
- Confirme que la red LAN inalámbrica del smartphone está activada.
- Confirme que su smartphone y este producto están conectados al mismo router inalámbrico.

## Instalación de la aplicación

### Usuarios de Android (Android 5.0 y superior)

- Abrir  .
- Busque la aplicación “Panasonic Comfort Cloud”.
- Descárguela e instálela.

### Usuarios de iOS (iOS 9 y superior)

- Abrir  .
- Busque la aplicación “Panasonic Comfort Cloud”.
- Descárguela e instálela.

## Nota

- Es posible que la interfaz de usuario de la aplicación cambie sin previo aviso si la versión se actualiza.
- El uso de esta aplicación es sin cargo. Sin embargo, podría incurrir en otros cargos de conexión y operación de red.

## Inicio de “Panasonic Comfort Cloud”

### Crear nuevo ID de Panasonic

Use la aplicación “Panasonic Comfort Cloud” como una opción para controlar este producto.

- En caso de ser un usuario nuevo, seleccione “Create new Panasonic ID” para registrarse.
- En caso de ser un usuario registrado, inicie sesión con su ID de Panasonic y su contraseña.

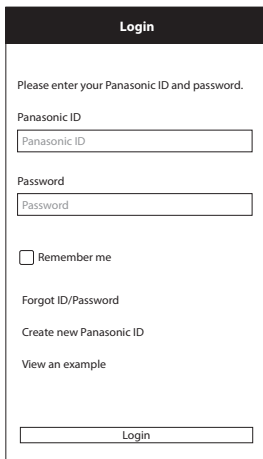

**Login**

Please enter your Panasonic ID and password.

Panasonic ID  
Panasonic ID

Password  
Password

Remember me

[Forgot ID/Password](#)

[Create new Panasonic ID](#)

[View an example](#)

Login

# Forma de uso

## Configuración de la aplicación

### Añadir un nuevo aire acondicionado

- Antes de usar la aplicación “Panasonic Comfort Cloud”, es necesario registrar este producto.

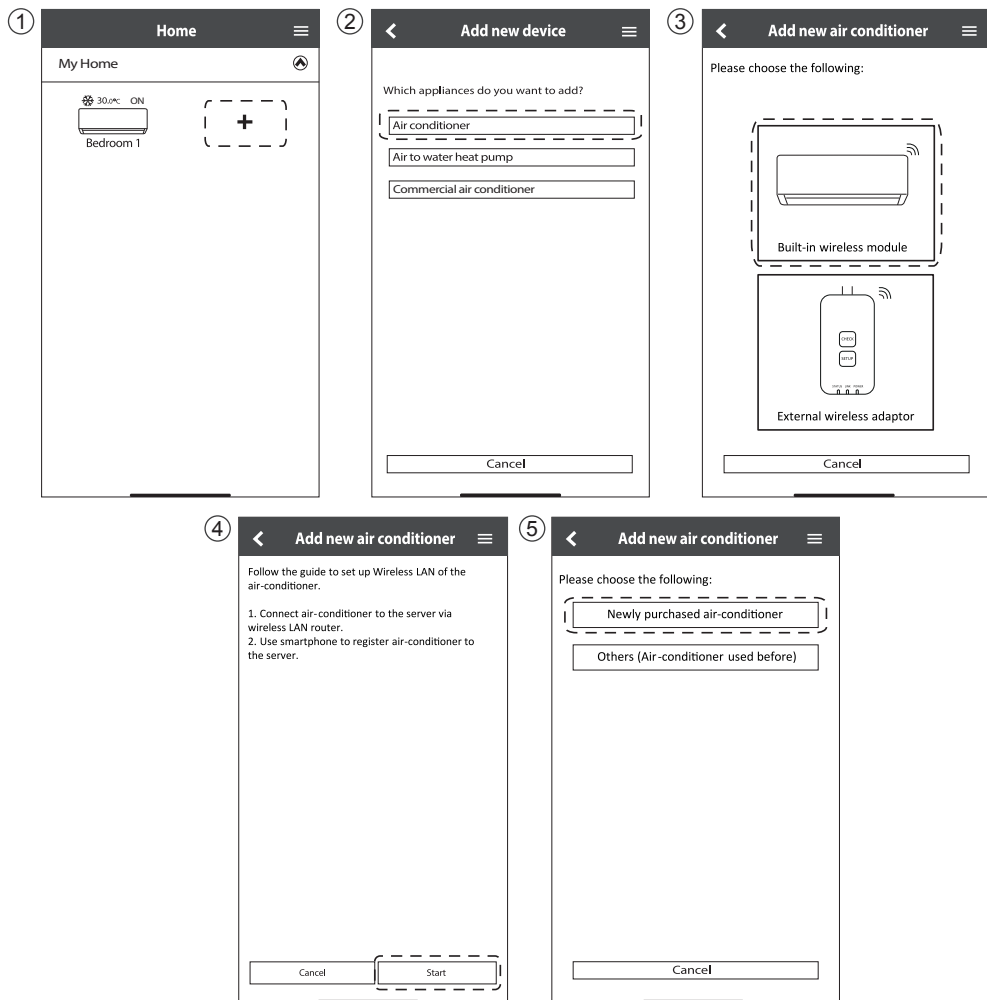

## Configurar la conexión a la red

- 1 Compruebe que el led de la red LAN inalámbrica esté ENCENDIDO. Apunte con el mando a distancia al aire acondicionado y pulse el botón  de LAN inalámbrica hasta que el led empiece a parpadear.

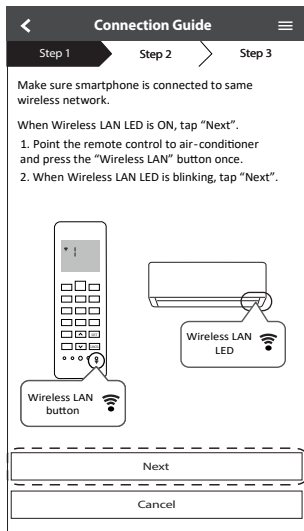

Parpadeo rápido	La unidad está estableciendo la conexión.
Parpadeo lento	La unidad no está asegurando la conexión.
Sin parpadeo (fijo)	La unidad ha establecido la conexión.

- Puede establecer la conexión a la unidad incluso si esta está APAGADA.

### Nota

- Si el led de la red LAN inalámbrica parpadea de forma continua y no desea utilizar la aplicación, pulse el botón  de LAN inalámbrica para apagarla.

- 2 Seleccione el estado del led de la red LAN inalámbrica.

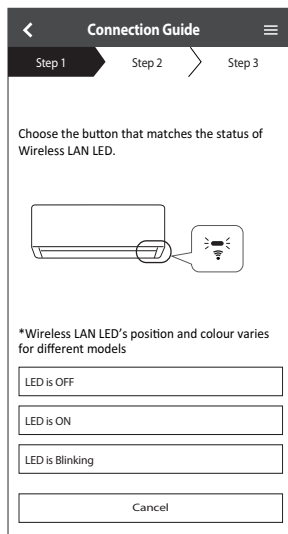

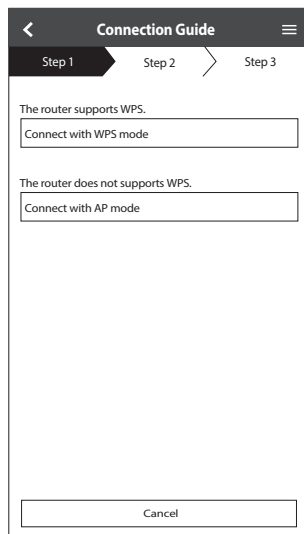

- 3 Seleccione el modo de configuración de conexión preferido.



# Forma de uso

## Conexión a la red con el modo WPS (método 1)

- 1 Pulse el botón WPS del router que se conectará al aire acondicionado.
  - Compruebe que el led de la red LAN inalámbrica esté ENCENDIDO. Si el led de la red LAN inalámbrica está APAGADO, pulse el botón  de LAN inalámbrica para encenderlo y para habilitar la conexión LAN inalámbrica.
- 2 Compruebe que el led de la red LAN inalámbrica esté ENCENDIDO. Pulse el botón  de LAN inalámbrica durante 5 segundos hasta que aparezca "1" en el mando a distancia. Apunte el mando a distancia hacia el aire acondicionado y pulse .

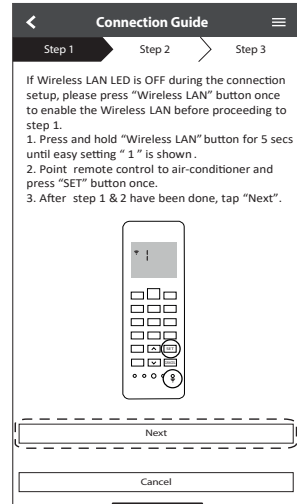
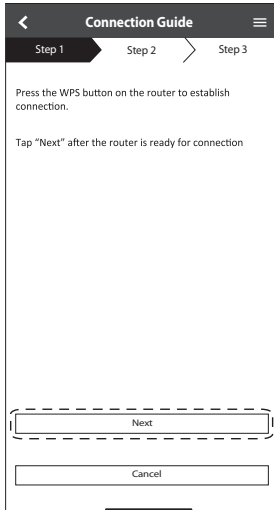

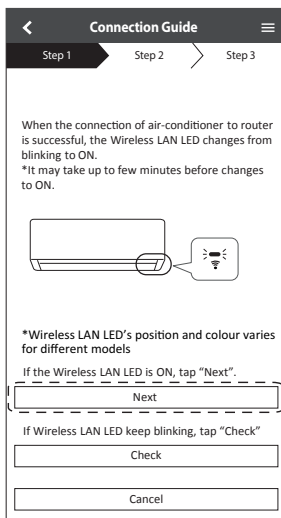

- 3 Cuando el aire acondicionado está correctamente conectado al router, el led de la red LAN inalámbrica deja de parpadear y se enciende.
- 4 Si el led de la red LAN inalámbrica sigue parpadeando, compruebe la conexión al router inalámbrico.



## Conexión a la red con el modo AP (método 2)

(Solo para Android 5.0 y versiones superiores e iOS 11 y versiones superiores)

- 1 Compruebe que el led de la red LAN inalámbrica esté ENCENDIDO. Pulse el botón  de LAN inalámbrica durante 5 segundos hasta que aparezca "1" en el mando a distancia. Pulse  hasta que aparezca "2". Apunte el mando a distancia hacia el aire acondicionado y pulse . Únase para conectar la red "Panasonic-CS-wirelessAP".

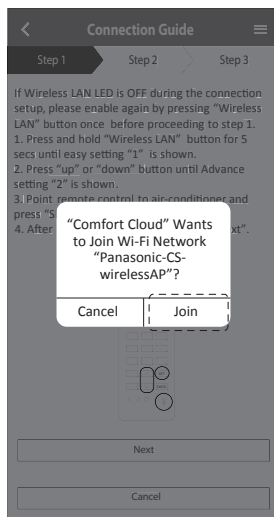
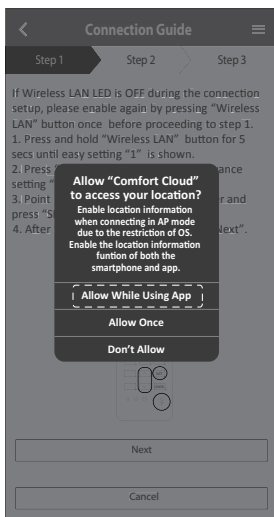
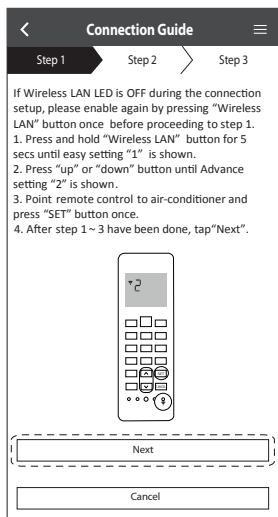

- 2 Ingrese la contraseña del enrutador inalámbrico seleccionado para continuar.

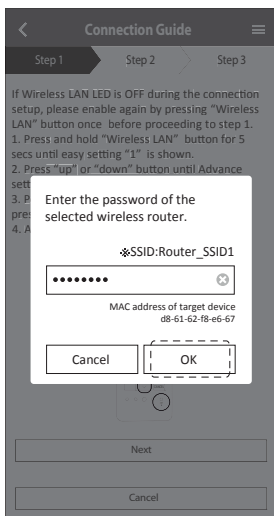

# Forma de uso

- ③ Cuando el aire acondicionado está conectado al router correctamente, el led de la red LAN inalámbrica deja de parpadear y se enciende. Si el led de la red LAN inalámbrica está ENCENDIDO, conecte el smartphone al router inalámbrico para continuar con la configuración.
- Si el led de la red LAN inalámbrica sigue parpadeando, compruebe la conexión al router inalámbrico.

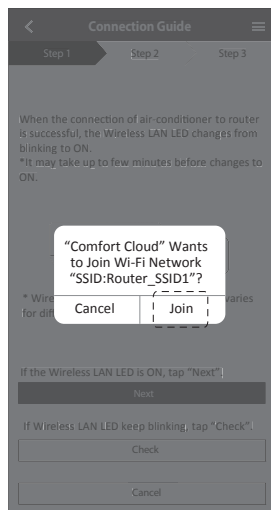
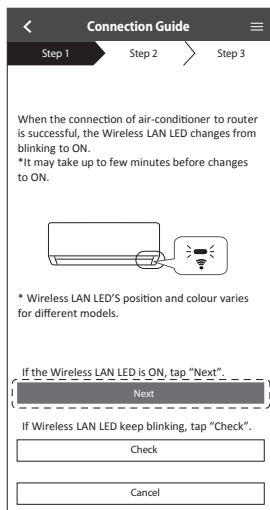

## Seleccione el aire acondicionado y establezca la contraseña

- ① Seleccione el modelo para registrar el aire acondicionado.

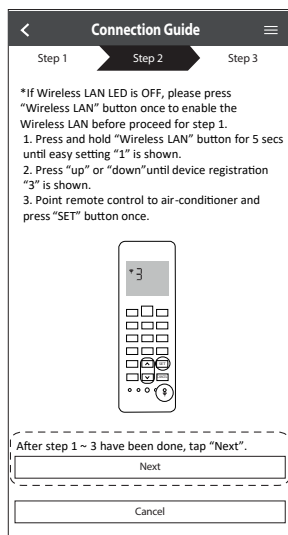
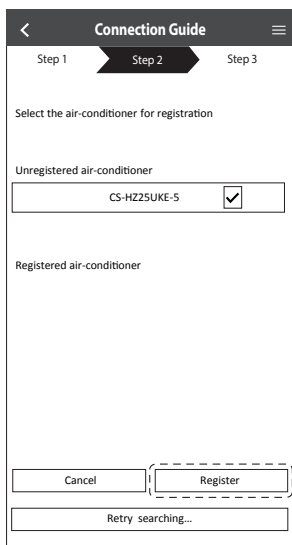

- ② Establezca una contraseña para completar el registro. La contraseña debe tener entre 8 y 15 caracteres de letras y números.

### Nota

- Guarde la contraseña para uso futuro. Puede utilizar la misma contraseña para registrar otros dispositivos Panasonic.

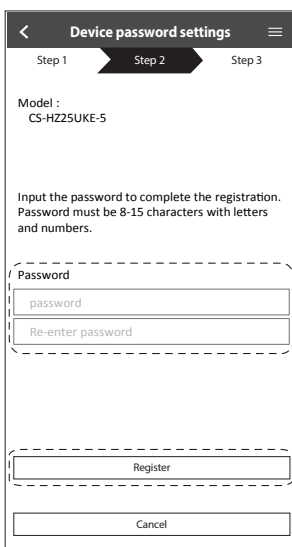

# Forma de uso

## Registro completo

- ① Una vez establecido el registro y la conexión entre la aplicación y el aire acondicionado, defina el nombre que desee para este aire acondicionado para que sea más fácil identificarlo.
  - Una vez registrado el nombre que desee para el aire acondicionado, puede usar las funciones de la aplicación “Panasonic Comfort Cloud”.
- ② Además del control de funcionamiento, la aplicación puede monitorizar el consumo energético estimado y comparar según distintos períodos haciendo referencia al gráfico de estadísticas.

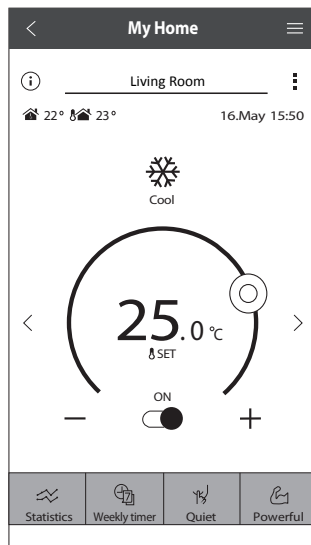
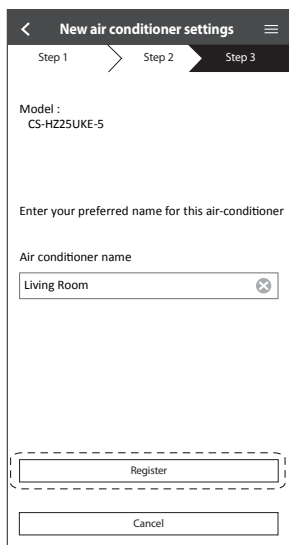

## Nota

- Compruebe el estado de conectividad de la aplicación antes y durante el funcionamiento. Si el estado no se refleja, use el mando a distancia para hacer funcionar el aire acondicionado.



## Inicie la aplicación

① Inicie sesión en la aplicación “Panasonic Comfort Cloud”.

② Seleccione el aire acondicionado a controlar.

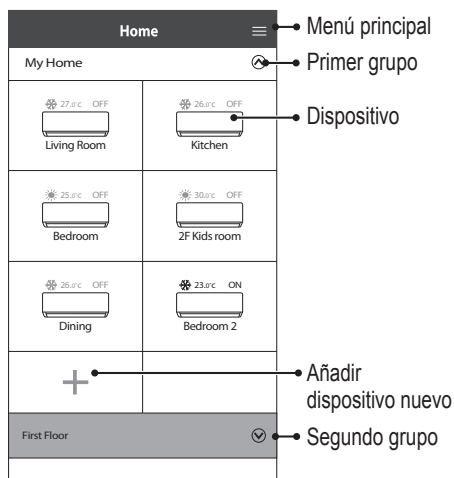
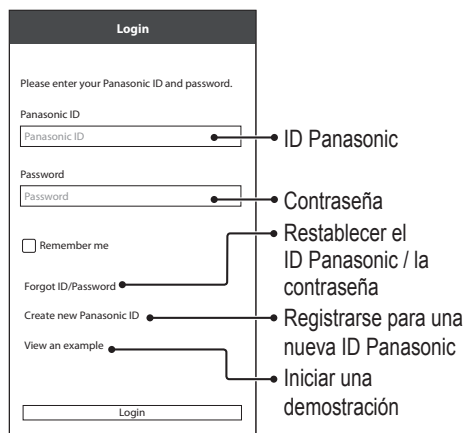

## Pantalla principal del dispositivo: configuración de operación

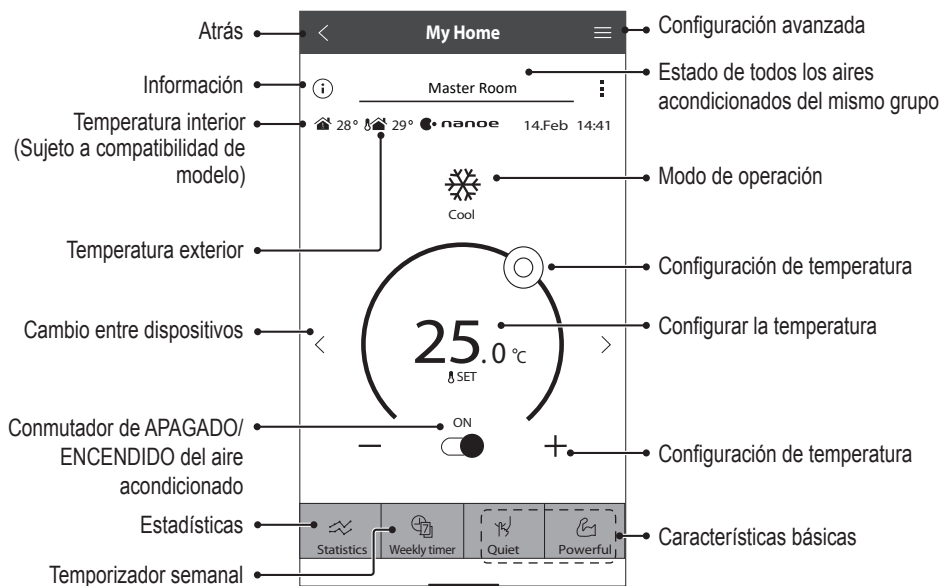

# Forma de uso

## Información

The 'Information' screen shows sections for 'Users awaiting your approval', 'Error messages', and 'Notifications'. The 'User approval' screen shows a confirmation dialog for 'User A' with radio button options for approval levels.

Aprobación de usuario

Derecho de control del usuario

Mensajes de error del acondicionador de aire

Notificaciones

Do not approve

Only allow monitoring air conditioner status

Allow both monitoring and controlling air conditioner

Confirm

## Estado del acondicionador de aire

The 'Air conditioners' screen lists rooms with their AC status and temperature. A dashed box highlights the room status and temperature information. A confirmation dialog asks to turn on all air conditioners.

Conmutador individual de APAGADO/ENCENDIDO del aire acondicionado

Estado de los aires acondicionados (APAGADO/ENCENDIDO, modo de operación y configuración de temperatura)

Todo apagado/ Todo encendido

Confirmation

Turn on all air conditioners?

Cancel OK

## Configuración avanzada

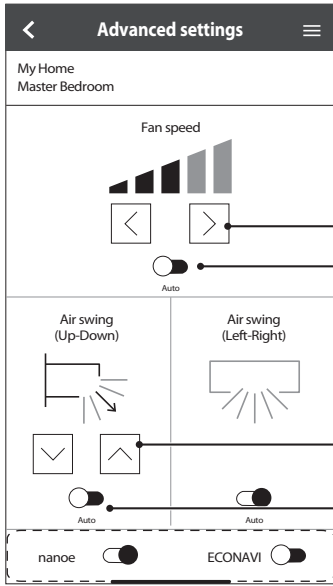

Configuración de la velocidad del ventilador

Selección del modo de operación (Sujeto a compatibilidad de modelo)

Conmutador de APAGADO/ENCENDIDO de la velocidad automática del ventilador

Configuración de la posición de oscilación de aire

Conmutador de APAGADO/ENCENDIDO de oscilación automática del aire

Conmutador de APAGADO/ENCENDIDO de las funciones adicionales

## Modo de operación

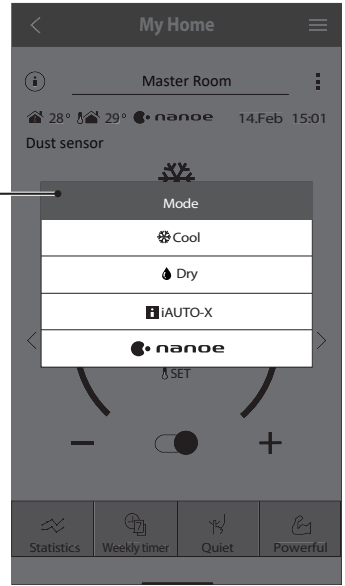

Forma de uso

## Estadísticas

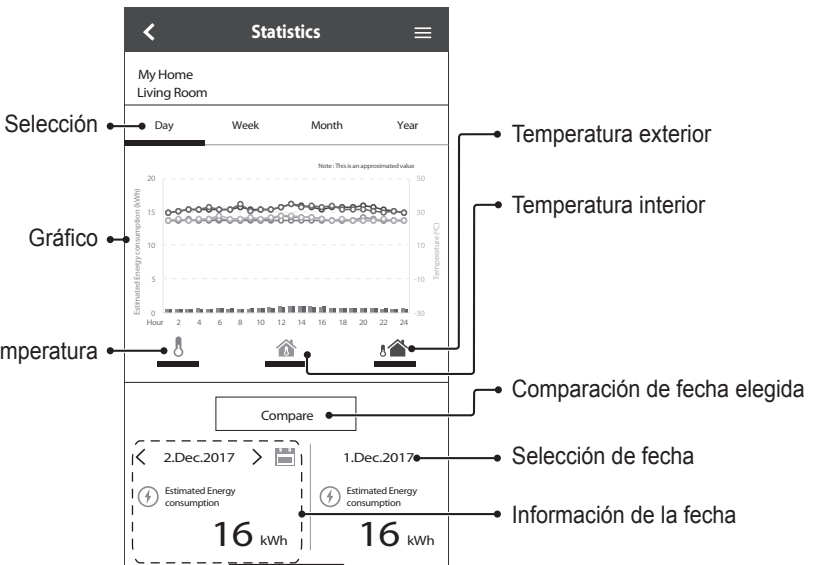

Selección

Gráfico

Configurar la temperatura

Temperatura exterior

Temperatura interior

Comparación de fecha elegida

Selección de fecha

Información de la fecha

## Nota

- El consumo energético estimado puede no ser admitido por determinados modelos.
- Para el sistema de AC de split múltiple: el valor de consumo de energía mostrado es para todo el sistema.

Español

# Forma de uso

## Temporizador semanal

- ① Presione “Weekly Timer” para ajustar el horario del temporizador.
- ② Presione .

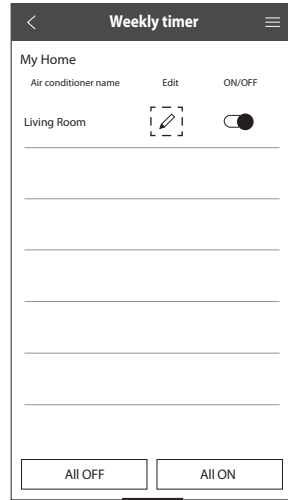
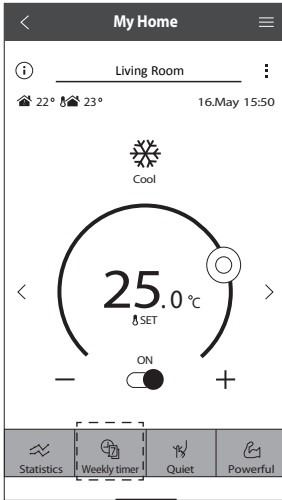

- ③ Presione  para añadir un programa nuevo. Se puede configurar un máximo de seis programas en un día.

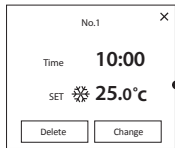

Editar el temporizador

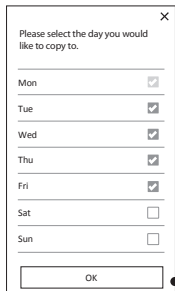

Copiar el temporizador

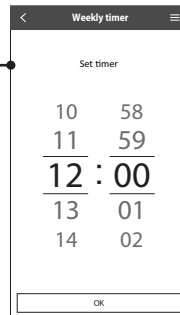
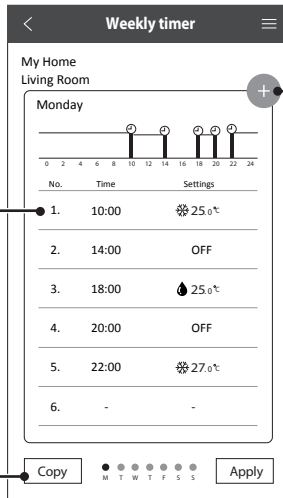

Ajuste la hora

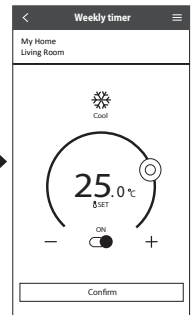

Establecer las condiciones

## Menú principal

El menú principal permite a los usuarios editar la configuración y brinda información importante.

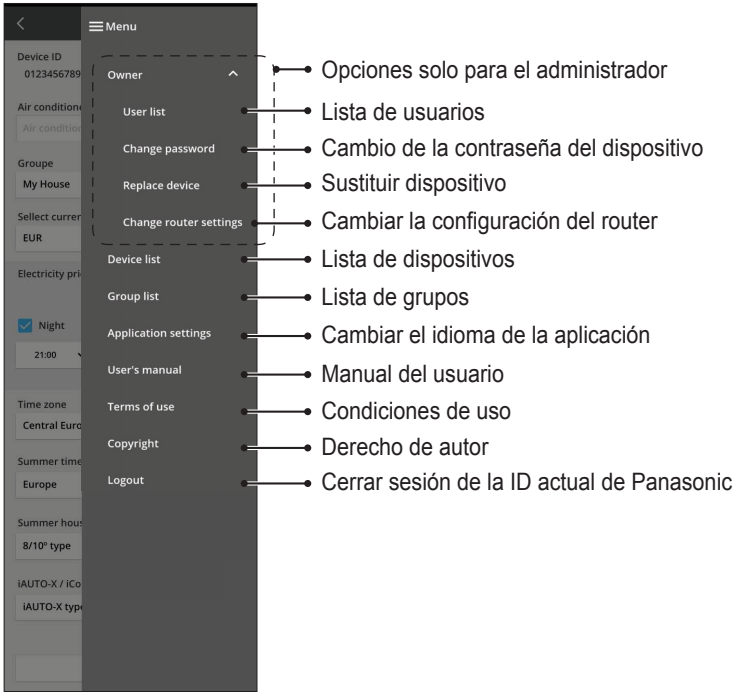

## Lista de usuarios

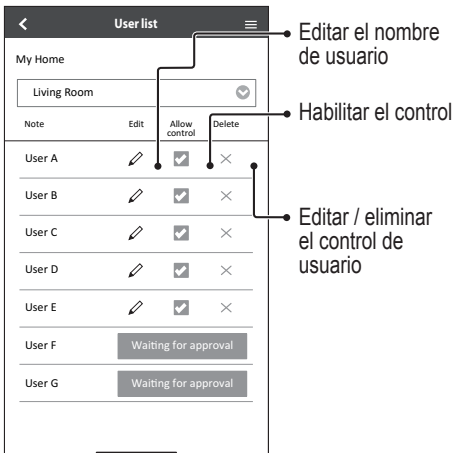

## Cambio de la contraseña del dispositivo

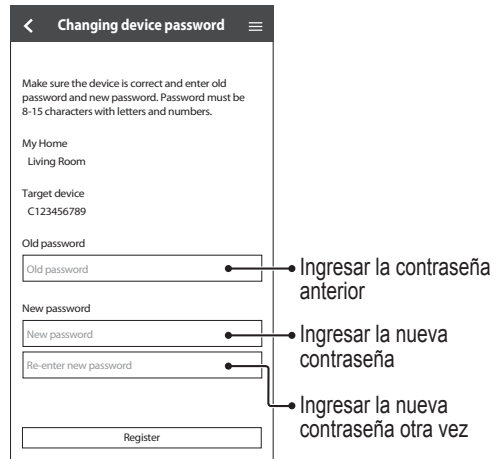

# Forma de uso

## Sustituir dispositivo

① Seleccionar "Replace device" del menú.

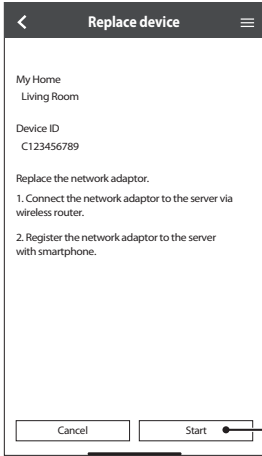

Presionar Iniciar

## Cambiar la configuración del router

② Seleccionar "Change router settings" del menú.

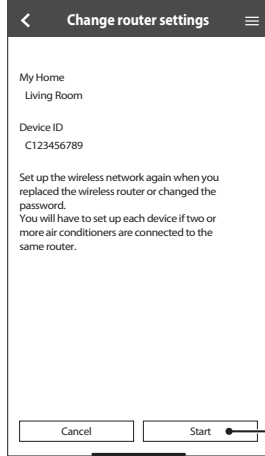

Presionar Iniciar

## Lista de dispositivos

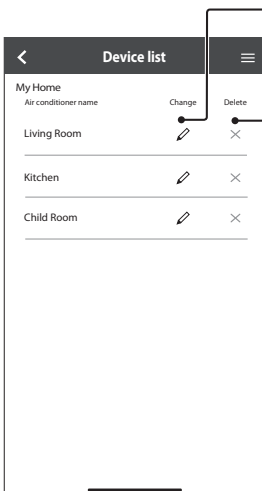

Editar la información del dispositivo y la configuración

Eliminar el dispositivo

## Lista de grupos

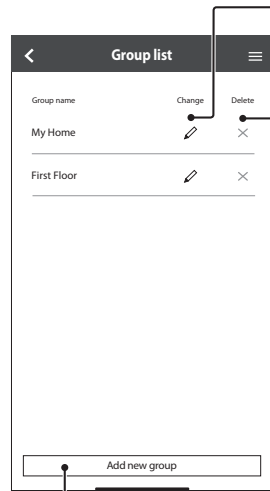

Editar el nombre del grupo

Eliminar el grupo

Añadir grupo nuevo





# Adaptador de red y preguntas sobre la aplicación

Antes de llamar al agente de servicio local, revise esta lista. Le ahorrará tiempo.

## Configuración inicial

Síntoma	Solución
La aplicación "Panasonic Comfort Cloud" no se puede instalar en el smartphone.	Compruebe si la versión del smartphone es compatible (Android 5.0 y superior o iOS9 y superior). No hay garantías de que la aplicación funcione correctamente con todas las versiones.
Registrar otro aire acondicionado en la aplicación "Panasonic Comfort Cloud".	Siga los pasos para la configuración inicial del aire acondicionado. Recomendamos poner nombre a las unidades de aire acondicionado registradas para que sea fácil distinguirlas.
Registrar otro usuario para que controle el adaptador de red.	Descargue la aplicación "Panasonic Comfort Cloud" y cree un nuevo ID de Panasonic. Siga los pasos de la configuración inicial. Cuando haya registrado el aire acondicionado, introduzca la contraseña que estableció el primer usuario (propietario). El propietario debe dar su aprobación para completar el registro. Para dar su aprobación, el propietario debe seleccionar  y, a continuación, seleccionar "Owner". Después de eso, seleccione "User List" para aprobar el usuario adicional.

## Conexión

Síntoma	Solución
El aire acondicionado y el router inalámbrico no se pueden conectar.	Compruebe que la señal LAN del router llegue a la unidad, el SSID no esté oculto, la configuración de la dirección MAC esté habilitada en la unidad, y que la señal de doble banda del router esté habilitada para una conexión de 2,4 GHz. Antes de configurar, compruebe la conexión a una red de 2,4 GHz. Algunos routers de red MESH se asignan automáticamente a una señal 5G. En ese caso, agregue un router dedicado de 2,4 GHz a la red.
No es posible conectarse a Cloud.	No se admite la red que requiere un inicio en el servidor. La dirección IP de PCPF y AFUS puede estar filtrada o bloqueada. Configure otra red LAN inalámbrica para productos de IoT. Para configurar, use el puerto 443 (URL: <a href="http://idcws.pcpf.panasonic.com">idcws.pcpf.panasonic.com</a> )
La señal inalámbrica está desconectada o se ha interrumpido.	Es posible que la conexión de red sea inestable. Para comprobar la intensidad de la señal con estos pasos: <ul style="list-style-type: none"> <li>• Detenga el funcionamiento del aire acondicionado y, a continuación, pulse el botón  de LAN inalámbrica durante 5 segundos hasta que aparezca "1" en el mando a distancia.</li> <li>• Pulse  hasta que aparezca "4".</li> <li>• Pulse  y dejará de funcionar.</li> <li>• Tras 5 segundos, el led de la red LAN inalámbrica de la unidad interior mostrará la intensidad de la señal. <ul style="list-style-type: none"> <li>Intensa: Parpadea 3 veces con un intervalo</li> <li>Moderado: Parpadea 2 veces con un intervalo</li> <li>Débil: Parpadea una vez con un intervalo</li> <li>Sin señal: OFF</li> </ul> </li> <li>• La conexión de red se detiene automáticamente después de 10 minutos. Pulse el botón  de LAN inalámbrica para detenerlo de inmediato.</li> </ul>
Acceso sospechoso o no autorizado a la unidad.	• Restablezca la unidad de aire acondicionado al estado predeterminado por el fabricante. Para más detalles, consulte "Otros: transferir o desechar el aire acondicionado" en este capítulo. A continuación, configure de nuevo la conexión de red.

# Adaptador de red y preguntas sobre la aplicación

## Aplicación “Panasonic Comfort Cloud”



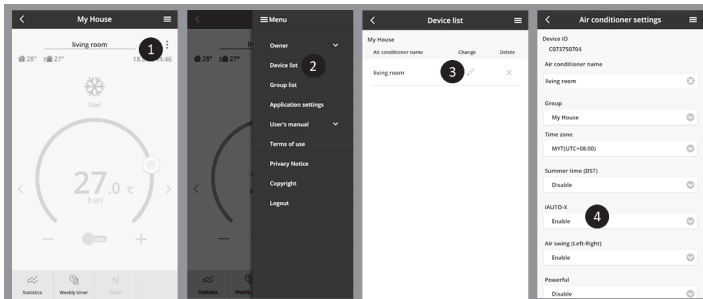



Síntoma	Solución
Inhabilite para recuperar el ID	Por el acta de protección de datos privados, el administrador de “Panasonic Comfort Cloud” no puede recuperar su ID. Cree una ID de Panasonic.
No he recibido el link para restablecer luego de seleccionar “Forgot ID/ password”	Se debe haber ingresado mal su dirección de correo. Seleccione “Forgot ID/ password” nuevamente.
Se cerró la sesión aunque “Remember me” estaba activado.	<ul style="list-style-type: none"> <li>El usuario rechazó el aviso.</li> <li>Por el acta de protección de datos privados, se cerrará la sesión automáticamente si no accede a la aplicación “Panasonic Comfort Cloud” durante 15 días consecutivos.</li> <li>La aplicación “Panasonic Comfort Cloud” se cerró en su teléfono. Vuelva a abrir la aplicación “Panasonic Comfort Cloud” sin conectarse a la red.</li> <li>El servidor de “Panasonic Comfort Cloud” está en mantenimiento o actualizándose.</li> <li>Su ID de Panasonic se usó para iniciar sesión en otro smartphone. Solo puede acceder con un ID Panasonic en un smartphone.</li> <li>Se limpiaron la memoria caché y el almacenamiento de “Panasonic Comfort Cloud”.</li> </ul> Vuelva a iniciar sesión en la aplicación “Panasonic Comfort Cloud”.
No se muestra el ícono Temperatura interior.	El ícono Temperatura interior solo se aplica a modelos con el diseño reciente.
Algunas funciones, como HEAT, iAUTO-X, Air Swing (izquierdo-derecho) y Powerful no están disponibles.	Las funciones se mostrarán según la configuración de cada país. Seleccione el país durante el registro de la ID. El administrador de la aplicación puede habilitar las características del producto de cada aire acondicionado del grupo de la siguiente forma:





Síntoma	Solución
El Temporizador semanal no funciona.	<p>Verifique si lo encendió en la aplicación "Panasonic Comfort Cloud" de esta forma:</p>  <p>Verifique si hay problemas entre el Temporizador semanal y el del control remoto. El temporizador del servidor y el del control pueden ser diferentes. El temporizador se activará en el tiempo menor.</p> <p>Verifique si la zona horaria se configuró bien de esta forma:</p> 

## Otros

Síntoma	Solución
Sustitución del router.	<p>Seleccione  en la aplicación "Panasonic Comfort Cloud". Seleccione "Owner" y seleccione "Change router settings".</p>
Cambiar el modelo de smartphone.	<p>Compruebe si la versión del smartphone es compatible (Android 5.0 y superior o iOS9 y superior). Instale la aplicación "Panasonic Comfort Cloud" e inicie sesión con su ID de Panasonic y su contraseña. Siga los pasos para la configuración inicial de la conexión.</p>
Cambiar el cuadro de control de la unidad interna.	<p>Cambie la tarjeta de control. A continuación, seleccione  en la aplicación "Panasonic Comfort Cloud". Seleccione "Owner" y seleccione "Replace device". Tenga en cuenta que lo deberá realizar el distribuidor de servicio autorizado.</p>
Cambio del adaptador de red/módulo LAN inalámbrico de la unidad interna.	<p>Cambie el módulo de adaptador de red/LAN inalámbrico. A continuación, seleccione  en la aplicación "Panasonic Comfort Cloud". Seleccione "Owner" y seleccione "Change router settings". Tenga en cuenta que lo deberá realizar el distribuidor de servicio autorizado.</p>
Transferir o desechar el aire acondicionado.	<p>Restablezca la unidad de aire acondicionado al estado predeterminado por el fabricante.</p> <ul style="list-style-type: none"> <li>• Asegúrese de que el led de la red LAN inalámbrica de la unidad interna esté ENCENDIDO/parpadeando y pulse el botón  de LAN inalámbrica durante 5 segundos hasta que aparezca "1" en el mando a distancia.</li> <li>• Pulse  hasta que aparezca "5".</li> <li>• Pulse  durante 3 segundos y dejará de funcionar.</li> <li>• El led de la red LAN inalámbrica está APAGADO y se ha completado el restablecimiento de fábrica.</li> </ul> <p>Para eliminar el registro del aire acondicionado de la aplicación "Panasonic Comfort Cloud", vaya al  y elija "Device list" para eliminar la unidad.</p>

# Localización de averías

Las siguientes señales no indican un mal funcionamiento.

Señal	Causa
El led de la red LAN inalámbrica está ENCENDIDO cuando la unidad está APAGADA.	• La conexión de la red LAN inalámbrica de la unidad con el router está activada.
El led de la red LAN inalámbrica parpadea de forma continua.	• La conexión de la red LAN inalámbrica de la unidad con el router no está establecida. Vuelva a comprobar su conexión. • Si no desea utilizar la aplicación, pulse el botón  de LAN inalámbrica para apagarla.

## Información



### Declaración de conformidad (DOC)

Por el presente, "Panasonic Corporation" declara que este producto cumple con los requisitos esenciales y demás disposiciones relevantes de la Directiva 2014/53/EU

El texto completo de la declaración de conformidad de la UE está disponible en la siguiente dirección de Internet: <http://www.ptc.panasonic.eu/>

Representante autorizado: Panasonic Testing Centre, Panasonic Marketing Europe GmbH, Winsbergring 15, 22525 Hamburgo, Alemania

Norway: Existen restricciones de uso en un radio de 20 km desde el centro de Ny-Alesund en Svalbard.

**Para obtener la última información de licencia de software y derechos de autor de este producto, consulte el último manual de usuario en nuestro sitio web :**

[https://accsmart.panasonic.com/Manual/Built-In/en/manual\\_en.pdf](https://accsmart.panasonic.com/Manual/Built-In/en/manual_en.pdf)

## **Función de actualización de firmware**

Este producto tiene funcionalidad para conectarse con el servidor de actualización de firmware de Panasonic en Internet para actualizar automáticamente el firmware del dispositivo a la versión más reciente.

Para actualizar el firmware, el dispositivo hará una revisión después de encender, una vez por día, para comprobar si cuenta con la versión más reciente. Si hace falta una actualización, esta se aplicará y el dispositivo reiniciará automáticamente. No es posible utilizar el dispositivo mientras reinicia (esto demora entre 1 y 5 minutos).

## **Información de licencia de software**

Este producto incorpora el siguiente software:

- (1) El software desarrollado de forma independiente por o para Panasonic Corporation,
- (2) El software que posee un tercero y otorga la licencia a Panasonic Corporation,
- (3) El software de código abierto bajo la licencia BSD o licencias equivalentes.

El software que se clasifica a partir de (3) se distribuye con la esperanza de que será útil, pero SIN ninguna GARANTÍA, sin incluso la garantía implícita de COMERCIALIZACION o IDONEIDAD PARA UN PROPÓSITO PARTICULAR.

Los siguientes términos de licencia se aplican a los componentes de código abierto.

### **1. Licencia de solicitante**

Copyright (C) 2003-2016, Jouni Malinen <j@w1.fi > y colaboradores.

Reservados todos los derechos.

Este software puede ser distribuido, usado y modificado bajo los términos de la licencia BSD:

La redistribución y el uso en forma de código fuente y binaria, con o sin modificación, están permitidos siempre que se cumplan las siguientes condiciones:

1. Las redistribuciones de código fuente deben conservar el aviso de copyright anterior, esta lista de condiciones y la siguiente exención de responsabilidad.
2. Las redistribuciones en forma binaria deben reproducir el aviso de derechos de autor anterior, esta lista de condiciones y la siguiente cláusula de exención de responsabilidad en la documentación y/u otros materiales proporcionados con la distribución.
3. Ni los nombres de los titulares de los derechos de autor arriba mencionados ni los nombres de sus colaboradores pueden ser usados para respaldar ni promocionar productos derivados de este software sin previa autorización específica por escrito.

LOS TITULARES DE LOS DERECHOS DE AUTOR Y LOS COLABORADORES OFRECEN ESTE SOFTWARE TAL CUAL, Y SE RECHAZA TODA GARANTÍA, EXPRESA O IMPLÍCITA, INCLUIDAS, ENTRE OTRAS, LAS GARANTÍAS IMPLÍCITAS DE COMERCIALIZACION E IDONEIDAD PARA UN FIN DETERMINADO. NI EL PROPIETARIO DE LOS DERECHOS DE AUTOR NI SUS COLABORADORES SERÁN RESPONSABLES EN NINGÚN CASO DE NINGÚN DAÑO DIRECTO, INDIRECTO, ACCIDENTAL, ESPECIAL, EJEMPLAR O CONSECUENTE (INCLUIDOS, A TÍTULO MERAMENTE ENUMERATIVO, PERO NO LIMITATIVO, LA ADQUISICIÓN DE BIENES O SERVICIOS SUSTITUTIVOS; PÉRDIDA DE USO O DATOS O LUCRO CESANTE; O INTERRUPCIÓN DE LA ACTIVIDAD COMERCIAL), INDEPENDIENTEMENTE DE SU CAUSA Y DE CUALESQUIER TEORÍAS DE RESPONSABILIDAD, YA SEA CONTRACTUAL, RESPONSABILIDAD OBJETIVA O EXTRA CONTRACTUAL (INCLUIDAS LA NEGLIGENCIA O CUALQUIER OTRA TEORÍA LEGAL) QUE SE DERIVEN DE CUALQUIER FORMA DEL USO DE ESTE SOFTWARE, INCLUSO SI SE AVISA DE LA POSIBILIDAD DE DICHOS DAÑOS.

# Der integrierte Netzwerkadapter ermöglicht Ihnen die Steuerung Ihres Klimageräts von jedem Standort aus.

Vielen Dank für den Kauf dieses Panasonic-Produkts.

## Inhalt

Sicherheitshinweise .....	68-69
Systemüberblick .....	70
Bedienung .....	71-84
F&A zu Netzwerkadaptern und Apps .....	85-87
Störungssuche .....	88
Informationen .....	88-89

## Sicherheitshinweise

Bevor Sie versuchen, dieses Klimagerätprodukt über drahtlose Kommunikation von einem entfernten Ort aus zu steuern / zu bedienen, überprüfen Sie unbedingt die Installation des Geräts und seiner Umgebung und seien Sie vorsichtig mit Personen in der Nähe.

Um Personen- oder Geräteschäden zu vermeiden, sind die nachfolgend aufgeführten Sicherheitshinweise zu beachten:

Die verwendeten Warnhinweise untergliedern sich entsprechend ihrer Wichtigkeit wie folgt:

 <b>VORSICHT</b>	Die Nichtbeachtung dieses Hinweises kann zu schweren Verletzungen oder gar zum Tod führen.
--	--

 <b>ACHTUNG</b>	Die Nichtbeachtung dieses Hinweises kann zu Verletzungen oder zu Beschädigungen führen.
---	---

Bei den folgenden Symbolen handelt es sich um Verbote bzw. Gebote:



Dieses Symbol weist darauf hin, dass eine bestimmte Tätigkeit NICHT durchgeführt werden darf.



Dieses Symbol weist darauf hin, dass eine bestimmte Tätigkeit durchgeführt werden MUSS.

 <b>VORSICHT</b>
---

### Netzwerkadapter (aktiviert)



Verwenden Sie das Innengerät nicht in der Nähe von medizinischen Geräten oder automatischen Kontrollgeräten (automatischen Türen, Brandmeldegeräten usw.). (Funkwellen vom Innengerät können das Gerät stören und zu Fehlfunktionen führen.)

# Sicherheitshinweise



Halten Sie sich bei einem Herzschrittmacher mindestens 15 cm von der Inneneinheit entfernt.  
(Die Funkwellen der Inneneinheit können die Funktion des Schrittmachers beeinträchtigen)



## ACHTUNG

### Netzwerkadapter (aktiviert)



Überprüfen Sie die folgenden Anforderungen im Voraus (Zu Hause):

- Stecken Sie das Netzteil richtig in die Steckdose. Stellen Sie sicher, dass die Stromversorgung nicht verstaubt ist. (Dies kann zu Bränden aufgrund von Zündung durch schlechte Kontakte der Stromversorgung führen)
- Überprüfen Sie den Status der durch eine andere Person eingestellten Timer-Aktivierung.  
(Ein unerwarteter Betrieb-Stopp-Vorgang kann den menschlichen Körper, Haustiere und Pflanzen schädigen)
- Es sollte keine Abnormalität in der Klimaanlage geben, wie z. B. eine Änderung des Luftstroms. Achten Sie darauf, dass sich keine Gegenstände davor befinden, die durch den direkt daran blasenden Luftstrom leicht verschoben werden können. Die heruntergefallenen oder bewegten Gegenstände können zu Gefahren wie Feuer, Verletzungen usw. führen.
- Verwenden Sie die hauseigene Fernbedienung immer dann, wenn die Möglichkeit besteht, dass Personen (z. B. Säuglinge, Kinder, Behinderte, ältere oder kranke Personen) die Temperatur nicht selbst regeln können und sich auf die voreingestellte Konfiguration der Klimaanlage verlassen. Der Anstieg und Abfall der Temperatur aufgrund der Fernbedienung kann dazu führen, dass sich die Insassen unwohl fühlen und / oder ihren Alltag stören. Pflanzen und Tiere sind wahrscheinlich von plötzlichen Temperaturschwankungen betroffen.



Überprüfen Sie die folgenden Anforderungen, bevor Sie die Klimaanlage von einem entfernten Ort aus betreiben:

- Informieren Sie die Person(en) in der Nähe des zu klimatisierenden Bereichs, dass Sie den Betrieb und die Einstellungen der Klimaanlage fernsteuern werden. Dadurch werden schwerwiegende Auswirkungen auf die Person(en) vermieden, die entweder durch Überraschungen oder durch plötzliche Temperaturschwankungen (von Komfort zu Kälte oder umgekehrt) verursacht werden können.  
(Dies kann den menschlichen Körper durch plötzliche Änderungen der Außentemperatur und der Raumtemperatur schädigen. Die Temperatureinstellung kann per Fernbedienung erfolgen)
  - Wenn die Hauptanzeige der Panasonic Comfort Cloud APP nicht den Status des Betriebs anzeigt, verwenden Sie bitte die hauseigene Fernbedienung, um die Klimaanlage zu bedienen.
- Da die APP die Netzwerkkommunikation verwendet, kann es vorkommen, dass der Remotebetrieb aufgrund von Kommunikations- und / oder Netzwerkfehlern nicht möglich ist (z. B. Ausfallzeiten von Panasonic Cloud-Servern, Serverausfallzeiten von Telekommunikationsanbietern, WLAN-Konnektivität usw.). Verwenden Sie in solchen Fällen die hauseigene Fernbedienung, um die Klimaanlage zu bedienen.

# Systemüberblick

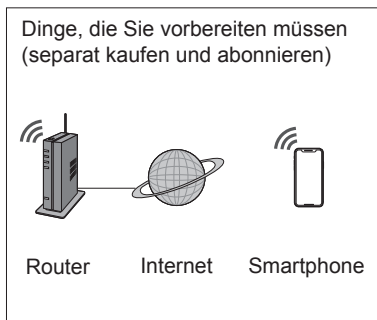
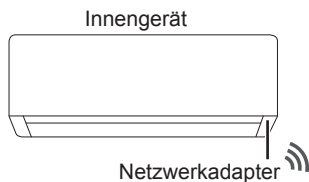

Herunterladen aus dem App-Store

Panasonic Comfort Cloud App (kostenlos)

- Um diese Funktion nutzen zu können, muss die App auf einem Smartphone mit Android 5.0 und höher oder mit iOS 9 und höher installiert sein.  
Es gibt jedoch keine Garantie dafür, dass die App mit allen Versionen problemlos funktioniert.
- Der Netzwerkadapter ist speziell als Endgerät für die „Panasonic Comfort Cloud“- App konzipiert.
- Die Abdeckung des WLAN-Netzwerks muss den Installationsort des Innengeräts einschließen.

## Spezifikation

Netzwerkadapter	WLAN-Modul (eingebaut)
Modell	DNSK-P11
Eingangsspannung	5 V DC (vom Innengerät der Klimaanlage)
Derzeitiger Verbrauch	Tx/Rx max. 290/100 mA
WLAN-Standard	IEEE 802,11 b/g/n
Frequenzbereich	2,4 GHz band
Verschlüsselung	WPA2-PSK (TKIP/AES)

## Vorsichtsmaßnahmen

- Zerlegen oder verändern Sie diesen Netzwerkadapter auf KEINE Weise.
- Entfernen Sie diesen Netzwerkadapter während des Betriebs NICHT aus dem Innengerät.
- Über Funk übertragene und empfangene Daten können abgefangen und überwacht werden.

## Maximale Hochfrequenzleistung, die in den Frequenzbändern übertragen wird

Art der Funkverbindung	Frequenzband	Max. EIRP (dBm)
WLAN	2412 - 2472 MHz	20 dBm

# Bedienung

## Vorsichtsmaßnahmen beim Gebrauch

- Lesen Sie vor der Verwendung des Produkts unbedingt alle Vorsichtsmaßnahmen in diesem Handbuch. Das Unternehmen haftet nicht für Mängel und Schäden durch Verwendung dieses Produkts, die durch unsachgemäßen Gebrauch durch Sie selbst oder einen Dritten entstehen, es sei denn, es wird eine gesetzliche Haftung in Bezug auf Ausfälle anerkannt.

## Sicherheitsmaßnahmen

- Wireless LAN verwendet Funkwellen, um Informationen auszutauschen. Daher besteht die Gefahr eines unbefugten Zugriffs.
- Initialisieren Sie die app-Einstellungen am Produkt, bevor Sie es entsorgen oder an Dritte übertragen.

## Vor dem Einstellen der Netzwerkverbindung

- Vergewissern Sie sich, dass der WLAN-Router korrekt mit dem Netzwerk verbunden ist.
- Vergewissern Sie sich, dass das WLAN des Smartphones aktiviert ist.
- Vergewissern Sie sich, dass Ihr Smartphone und dieses Produkt mit demselben WLAN-Router verbunden sind.

## App-Installation

Für Android-Benutzer (Android 5.0 und höher)

- Öffnen Sie .
- Suchen Sie nach der „Panasonic Comfort Cloud“-App.
- Laden Sie sie herunter und installieren Sie sie.

Für iOS-Benutzer (iOS 9 und höher)

- Öffnen Sie .
- Suchen Sie nach der „Panasonic Comfort Cloud“-App.
- Laden Sie sie herunter und installieren Sie sie.

## Hinweis

- Das Erscheinungsbild der App-Benutzeroberfläche kann sich bei Versions-Upgrades ohne Ankündigung ändern.
- Die Nutzung dieser App ist kostenlos. Es können jedoch weitere Kosten für die Netzwerkverbindung und den Betrieb anfallen.

## Starten der „Panasonic Comfort Cloud“

### Erstellen einer neuen Panasonic-ID

Verwenden Sie die „Panasonic Comfort Cloud“-App als eine Option zur Steuerung dieses Produkts.

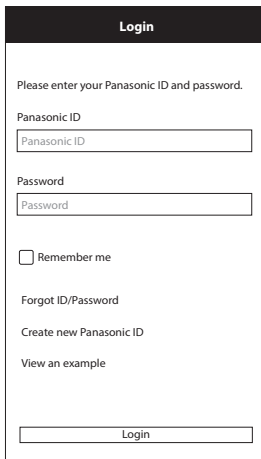

- Als neuer Benutzer wählen Sie zum Registrieren die Option „Create new Panasonic ID“.
- Als registrierter Benutzer melden Sie sich mit Ihrer Panasonic-ID und Ihrem Passwort an.

# Bedienung

## App-Einstellung

### Neues Klimagerät hinzufügen

- Sie müssen dieses Produkt registrieren, bevor Sie die „Panasonic Comfort Cloud“-App nutzen können.

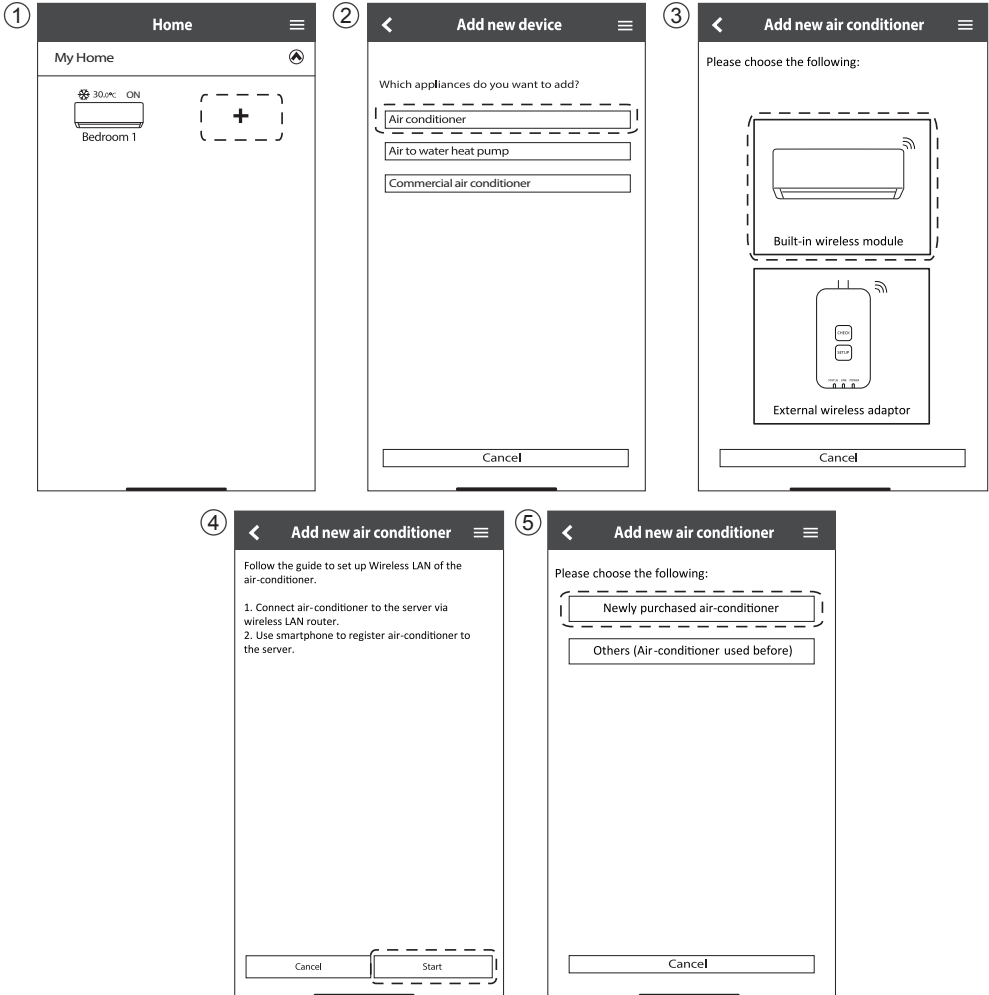



## Einstellen der Netzwerkverbindungen

- ① Vergewissern Sie sich, dass die WLAN-LED leuchtet. Richten Sie die Fernbedienung auf das Klimagerät und drücken Sie die WLAN-Taste , bis die WLAN-LED blinkt.

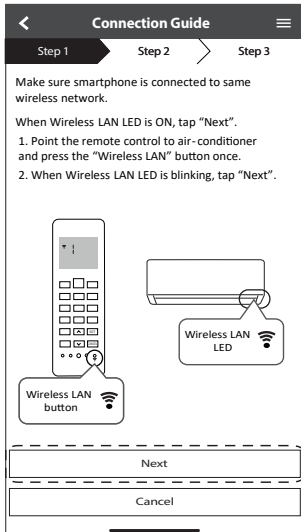

Schnelles Blinken	Das Gerät baut die Verbindung auf.
Langsames Blinken	Das Gerät sichert die Verbindung nicht.
Kein Blinken (bleibt an)	Das Gerät hat die Verbindung hergestellt.

- Es kann die Verbindung zum Gerät herstellen, auch wenn das Gerät ausgeschaltet ist.

### Hinweis

- Wenn die WLAN-LED ununterbrochen blinkt und Sie die APP nicht verwenden möchten, drücken Sie zum Ausschalten die WLAN-Taste .

- ② Wählen Sie den Status der WLAN-LED aus.

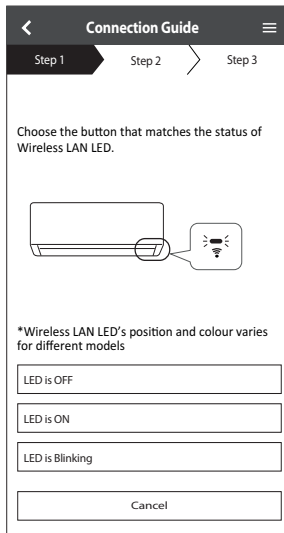

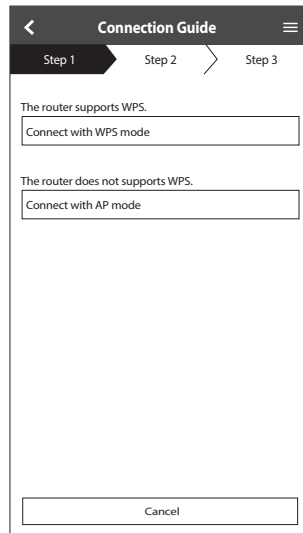

- ③ Wählen Sie den bevorzugten Verbindungsaufbau-Modus aus.



# Bedienung

## Netzwerkverbindung im WPS-Modus (Methode 1)

- ① Drücken Sie die „WPS“-Taste des Routers, der an ein Klimagerät angeschlossen wird.
  - Vergewissern Sie sich, dass die WLAN-LED leuchtet. Wenn die WLAN-LED aus ist, drücken Sie die WLAN-Taste , um die WLAN-Verbindung zu aktivieren.
- ② Vergewissern Sie sich, dass die WLAN-LED leuchtet. Halten Sie die WLAN-Taste  5 Sekunden lang gedrückt, bis auf der Fernbedienung „1“ angezeigt wird. Richten Sie die Fernbedienung auf das Klimagerät und drücken Sie die Taste .

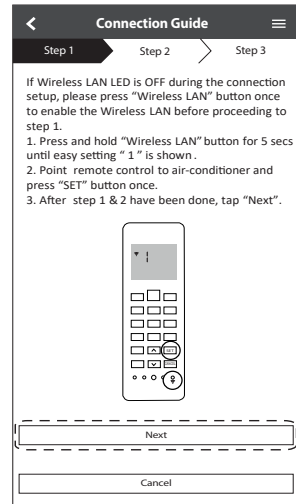
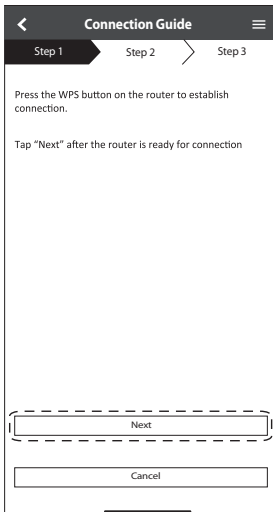

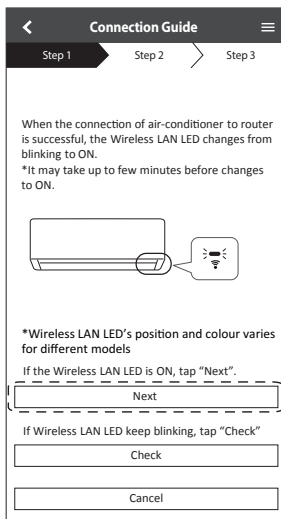

- ③ Wenn die Verbindung des Klimageräts mit dem Router erfolgreich war, blinkt die WLAN-LED nicht mehr, sondern leuchtet durchgehend.
- ④ Wenn die WLAN-LED weiterhin blinkt, überprüfen Sie die Verbindung zum WLAN-Router.



## Netzwerkverbindung im AP -Modus (Methode 2)

(Nur für Android 5.0 und höher und iOS 11 und höher)

- 1 Vergewissern Sie sich, dass die WLAN-LED leuchtet. Halten Sie die WLAN-Taste  5 Sekunden lang gedrückt, bis auf der Fernbedienung „1“ angezeigt wird. Drücken Sie die Taste , bis „2“ angezeigt wird. Richten Sie die Fernbedienung auf das Klimagerät und drücken Sie die Taste . Treten Sie bei, um sich mit dem „Panasonic-CS-wirelessAP“-Netzwerk zu verbinden.

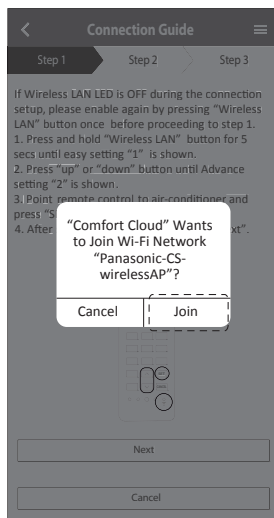
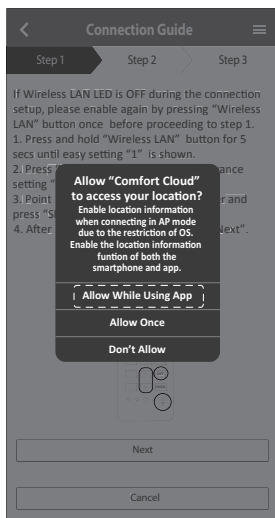
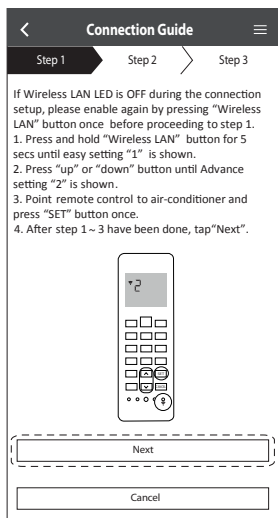

- 2 Geben Sie das Passwort des ausgewählten drahtlosen Routers ein und fahren Sie fort.

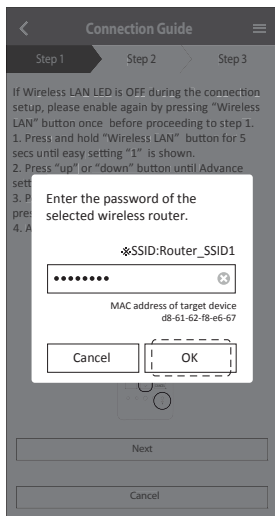

# Bedienung

- ③ Wenn die Verbindung des Klimageräts mit dem Router erfolgreich war, blinkt die WLAN-LED nicht mehr, sondern leuchtet durchgehend. Wenn die WLAN-LED leuchtet, schließen Sie das Smartphone an den WLAN-Router an, um mit der Einrichtung fortzufahren.
- Wenn die WLAN-LED weiterhin blinkt, überprüfen Sie die Verbindung zum WLAN-Router.

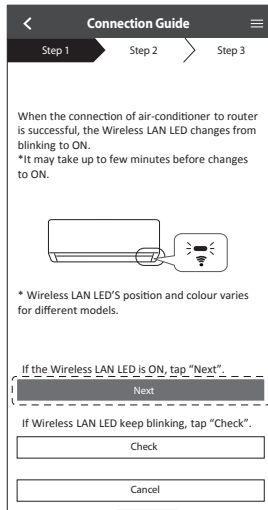

## Wählen Sie die Klimaanlage und legen Sie das Passwort fest.

- ① Wählen Sie das Modell aus, um das Klimagerät zu registrieren.

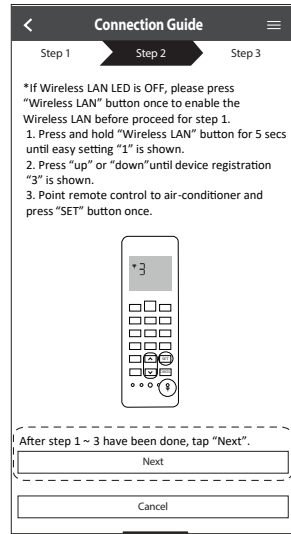
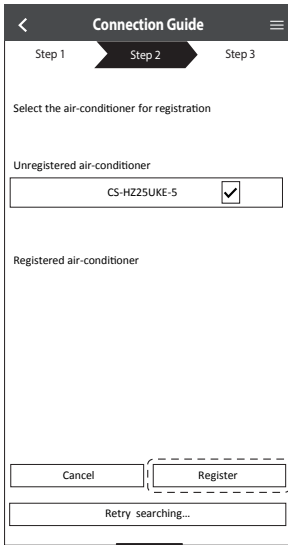

- ② Legen Sie ein Passwort fest, um die Registrierung abzuschließen. Das Passwort muss aus 8–15 Zeichen bestehen sowie Buchstaben und Zahlen enthalten.

### Hinweis

- Merken Sie sich das Passwort zur späteren Verwendung. Zur Registrierung weiterer Panasonic-Geräte können Sie dasselbe Passwort verwenden.

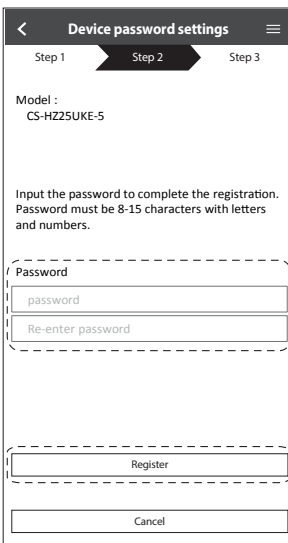

# Bedienung

## Registrierung abgeschlossen

- ① Nachdem die Verbindung zwischen der App und dem Klimagerät hergestellt ist, geben Sie den bevorzugten Namen für dieses Klimagerät ein, um es leicht identifizieren zu können.
  - Nachdem Sie den bevorzugten Namen für das Klimagerät angegeben haben, können Sie die Funktionen der „Panasonic Comfort Cloud“-App nutzen.
- ② Neben der Betriebssteuerung kann diese Anwendung den geschätzten Energieverbrauch überwachen und den Vergleich für verschiedene Zeiträume anhand eines Statistikdiagramms durchführen.

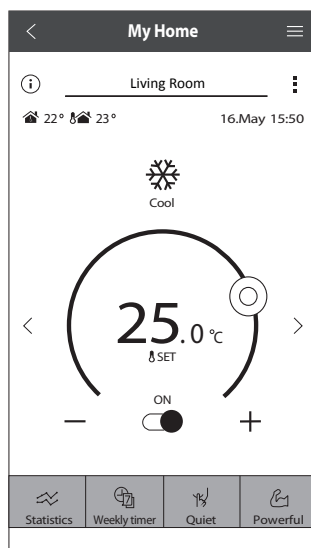
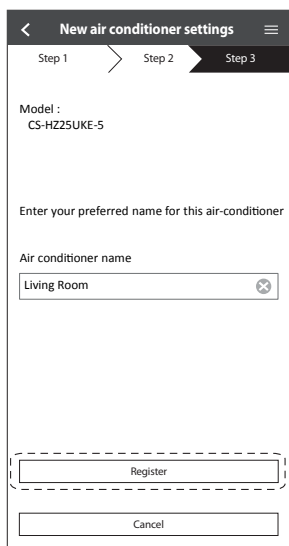

## Hinweis

- Prüfen Sie vor und während des Betriebs den Verbindungsstatus der App. Wenn der Status nicht angezeigt wird, verwenden Sie zum Bedienen des Klimageräts die Fernbedienung.

## Starten Sie die Anwendung

- ① Melden Sie sich bei der „Panasonic Comfort Cloud“-App an.

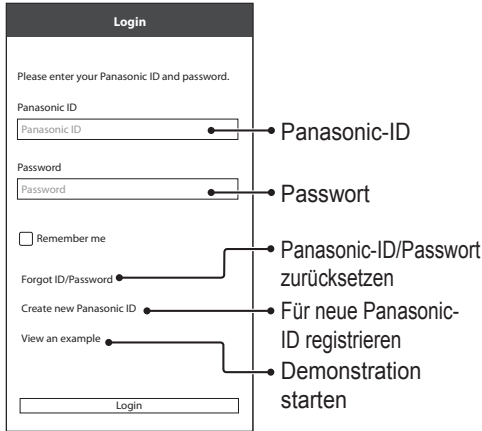

- ② Wählen Sie Ihre zu steuernde Klimaanlage aus.

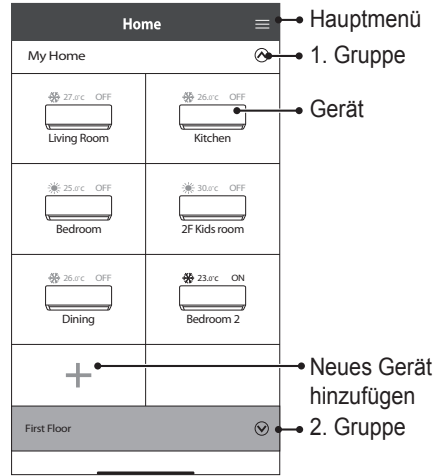

## Hauptgerätebildschirm – Einstellung des Betriebs

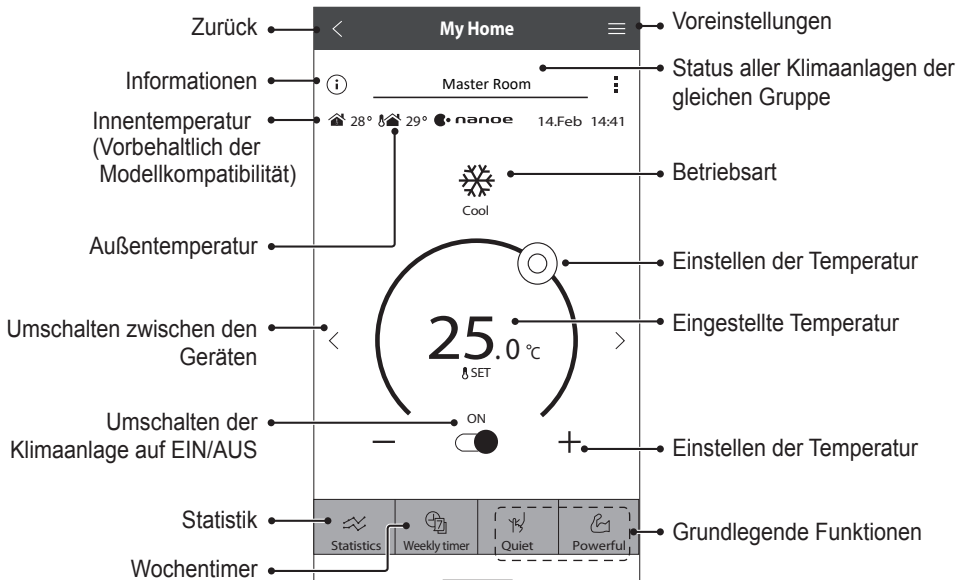

# Bedienung

## Informationen

The 'Information' screen shows sections for 'Users awaiting your approval', 'Error messages', and 'Notifications'. The 'User approval' screen shows a confirmation dialog for 'User A' with options to approve or deny monitoring and controlling the air conditioner.

Benutzerfreischaltung

Benutzersteuerungsrecht

Fehlermeldungen der Klimaanlage

Benachrichtigungen

Do not approve

Only allow monitoring air conditioner status

Allow both monitoring and controlling air conditioner

Confirm

## Status der Klimaanlage

The 'Air conditioners' screen lists rooms with their status (OFF/ON), temperature, and a toggle switch. A confirmation dialog asks to turn on all air conditioners.

Individuelles Umschalten der Klimaanlage auf EIN/AUS

Status der Klimaanlage (EIN/AUS, Betriebsart und eingestellte Temperatur)

Alle AUS/alle EIN

Confirmation

Turn on all air conditioners?

Cancel OK



## Voreinstellungen

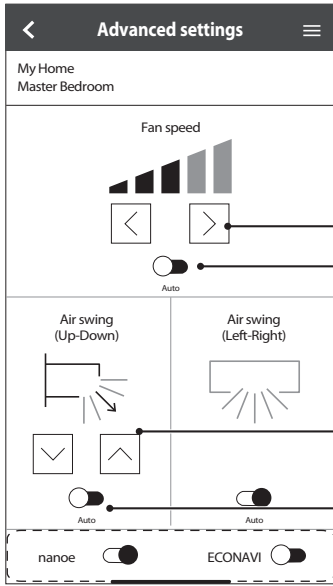

Einstellung der Ventilatorrehzahl

Auswahl der Betriebsart (Vorbehaltlich der Modellkompatibilität)

Automatische Umschaltung der Lüftergeschwindigkeit auf AUS/EIN

Einstellen der Luftschwungsstellung

Automatische Umschaltung der Luftschwingung auf AUS/EIN

Zusätzliche Funktionen der AUS/EIN-Umschaltung

## Betriebsart

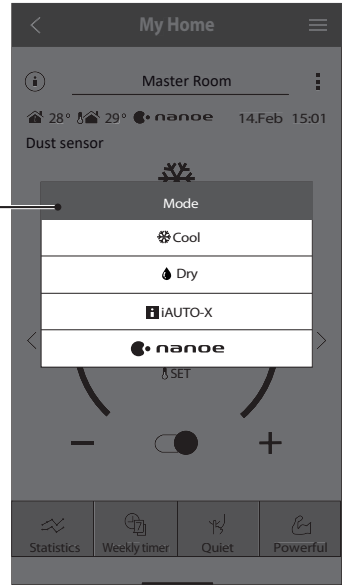

## Statistik

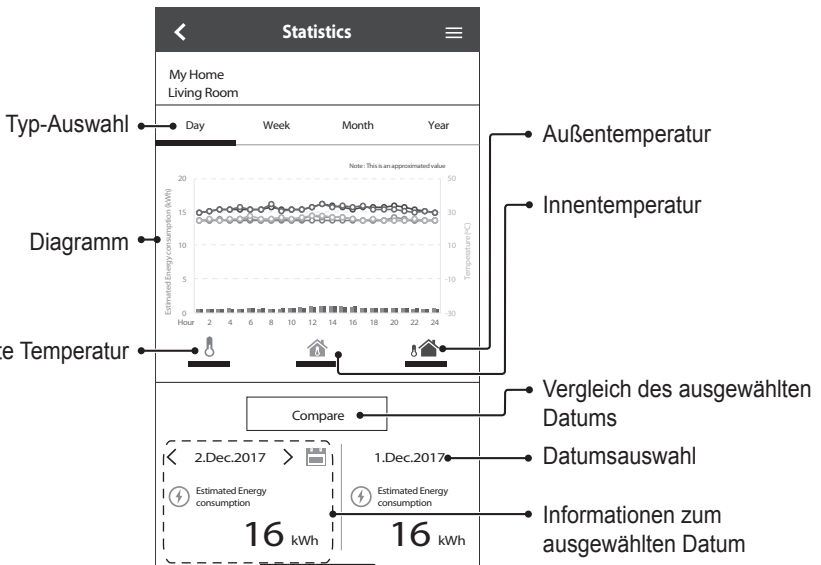

Typ-Auswahl

Diagramm

Eingestellte Temperatur

Außentemperatur

Innentemperatur

Vergleich des ausgewählten Datums

Datumsauswahl

Informationen zum ausgewählten Datum

## Hinweis

- Der geschätzte Energieverbrauch wird von bestimmten Modellen eventuell nicht unterstützt.
- Bei Multi-Split-Geräten: der angezeigte Energieverbrauchswert bezieht sich auf das gesamte System.

# Bedienung

## Wochentimer

- 1 Tippen Sie auf „Weekly Timer“, um den Timer einzustellen.
- 2 Tippen Sie auf .

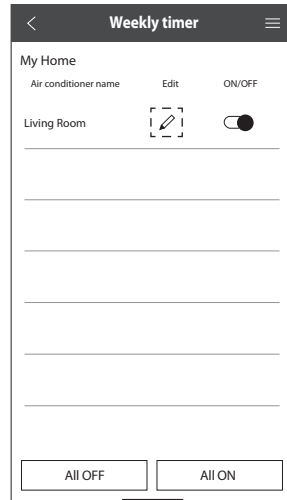
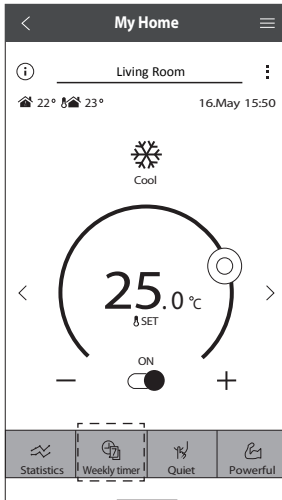

- 3 Tippen Sie auf , um ein neues Programm hinzuzufügen. Sie können maximal sechs Programme für einen Tag einstellen.

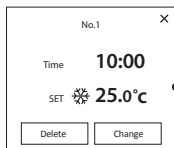

Schaltuhr bearbeiten

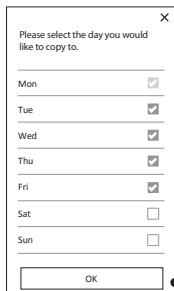

Schaltuhr kopieren

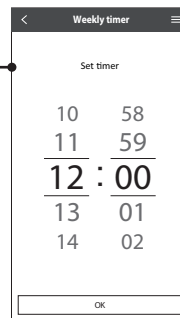
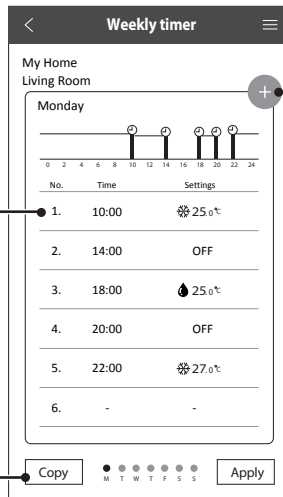

Zeit einstellen

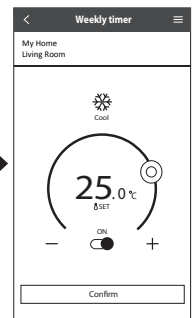

Bedingungen einstellen

## Hauptmenü

Das Hauptmenü ermöglicht dem Benutzer die Bearbeitung der Geräteeinstellungen und liefert wichtige Informationen.

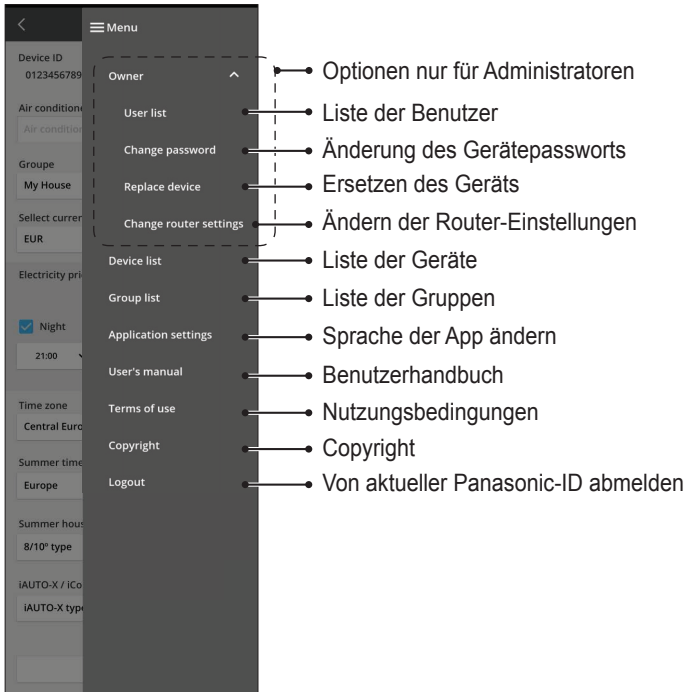

## Benutzerliste

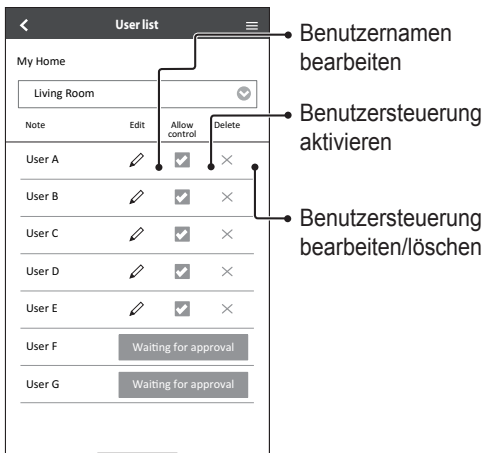

## Änderung des Gerätepassworts

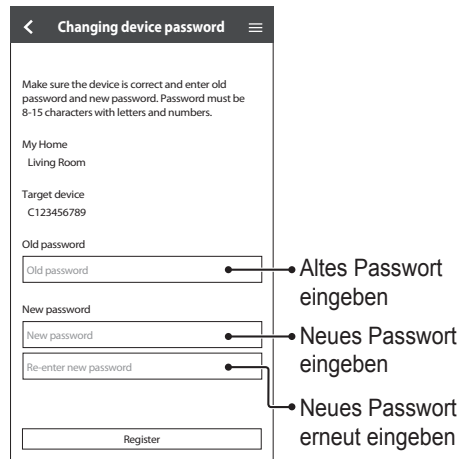

# Bedienung

## Ersetzen des Geräts

- 1 Wählen Sie „Replace device“ aus dem Menü.

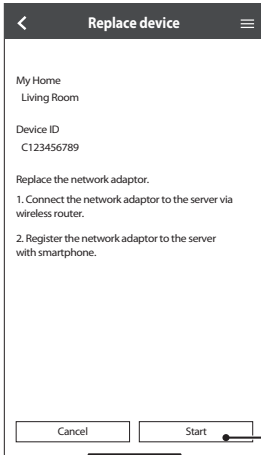

Tippen Sie auf Start

## Ändern der Router-Einstellungen

- 2 Wählen Sie „Change router settings“ aus dem Menü.

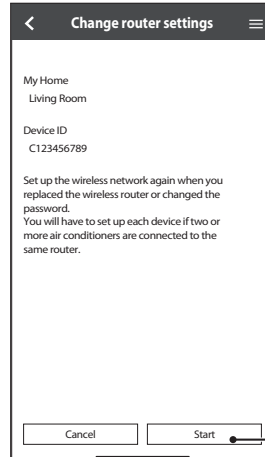

Tippen Sie auf Start

## Geräteliste

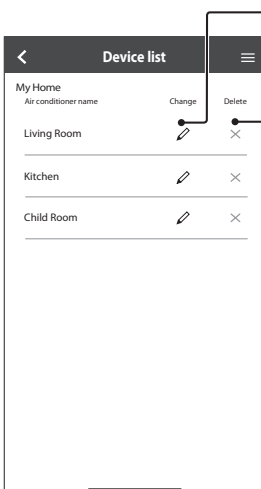

Geräteinformationen und -einstellungen bearbeiten

Gerät löschen

## Gruppenliste

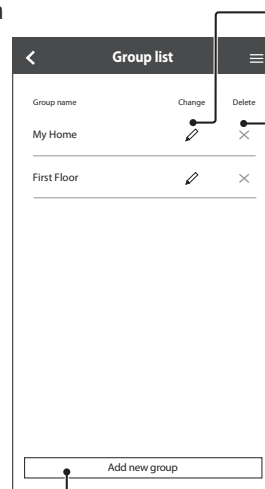

Gruppennamen bearbeiten

Gruppe löschen

Benutzergruppe hinzufügen





# F&A zu Netzwerkadaptern und Apps

Bevor Sie Ihre örtliche Servicestelle anrufen, lesen Sie bitte diese Liste durch. Vielleicht sparen Sie dadurch etwas Zeit.

## Grundeinstellung

Symptom	Lösung
Die „Panasonic Comfort Cloud“-App kann nicht auf dem Smartphone installiert werden.	Prüfen Sie, ob Ihre Smartphoneversion kompatibel ist (Android 5.0 und höher oder iOS 9 und höher). Es gibt keine Garantie dafür, dass die App mit allen Versionen problemlos funktioniert.
Registrieren Sie eine zusätzliche Klimaanlage in der „Panasonic Comfort Cloud“-App.	Befolgen Sie die Schritte für die Ersteinrichtung des Klimageräts. Wir empfehlen, dass Sie jedem registrierten Klimagerät einen Namen zuweisen, sodass sie die Geräte einfach unterscheiden können.
Registrieren Sie weitere Benutzer zur Steuerung des Netzwerkadapters.	Laden Sie die „Panasonic Comfort Cloud“-App herunter und erstellen Sie eine neue Panasonic-ID. Folgen Sie der Grundeinstellung. Nachdem das Klimagerät registriert wurde, geben Sie das vom ersten Benutzer (Eigentümer) festgelegte Passwort ein. Der Eigentümer muss das Abschließen der Registrierung genehmigen. Hierzu muss der Eigentümer  und dann „Owner“ auswählen. Wählen Sie anschließend „User List“ aus, um den zusätzlichen Benutzer zu genehmigen.

## Verbindung

Symptom	Lösung
Klimaanlage und kabelloser Router können nicht verbunden werden.	Stellen Sie sicher, dass das WLAN-Signal des Routers das Gerät erreicht, die SSID nicht versteckt ist, die MAC-Adresseneinstellung für das Gerät aktiviert ist und das Dual-Band-Signal des Routers für eine 2,4 GHz-Verbindung aktiviert ist. Stellen Sie vor der Einrichtung sicher, dass Ihr Smartphone an ein 2,4-GHz-Netzwerk angeschlossen ist. Einem MESH-Netzwerkrouter wird automatisch ein 5G-Signal zugewiesen. Fügen Sie in diesem Fall dem vorhandenen Netzwerk einen dedizierten 2,4-GHz-Router hinzu.
Verbindung zum Cloud-Server nicht möglich.	Unternehmensnetzwerke, die eine Serveranmeldung erfordern, werden nicht unterstützt. Die IP-Adressen von PCPF und AFUS können gefiltert oder blockiert worden sein. Richten Sie ein separates WLAN-Netzwerk für IoT-Produkte ein. Verwenden Sie zur Einstellung des Routers Port: 443; und den URL: <a href="http://Idcws.pcpf.panasonic.com">Idcws.pcpf.panasonic.com</a>
Das drahtlose Signal wird getrennt oder unterbrochen.	Möglicherweise ist Ihre Netzwerkverbindung nicht stabil. Prüfen Sie die Signalstärke mithilfe der folgenden Schritte: <ul style="list-style-type: none"> <li>• Schalten Sie das Klimagerät aus und halten Sie die WLAN-Taste  5 Sekunden lang gedrückt, bis auf der Fernbedienung „1“ angezeigt wird.</li> <li>• Drücken Sie die Taste , bis „4“ angezeigt wird.</li> <li>• Drücken Sie , und der Betrieb wird eingestellt.</li> <li>• Nach 5 Sekunden zeigt die WLAN-LED am Innengerät die Signalstärke an. <ul style="list-style-type: none"> <li>Stark: 3-maliges Blinken mit Intervall</li> <li>Mäßig: 2-maliges Blinken mit Intervall</li> <li>Schwach: 1-maliges Blinken mit Intervall</li> <li>Kein Signal: AUS</li> </ul> </li> <li>• Die Netzwerkverbindung wird nach 10 Minuten automatisch angehalten. Drücken Sie die WLAN-Taste , um sie sofort zu unterbrechen.</li> </ul>
Verdächtiger oder unbefugter Zugriff auf das Gerät.	• Setzen Sie das Klimagerät auf die Werkseinstellungen zurück. Nähere Informationen finden Sie unter „Sonstiges – Transportieren oder Entsorgen der Klimaanlage“ in diesem Kapitel. Richten Sie anschließend die Netzwerkverbindung erneut ein.

# F&A zu Netzwerkadaptern und Apps





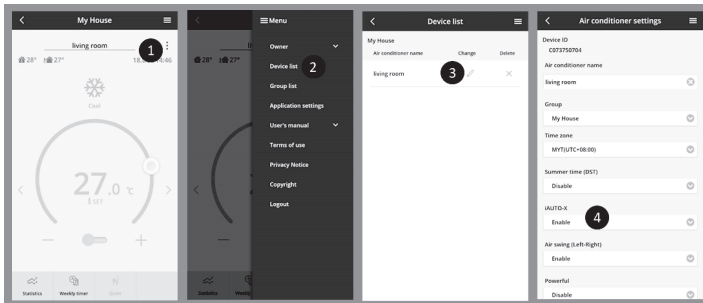

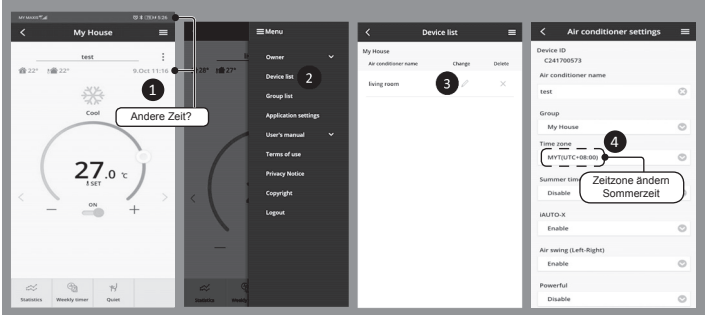
## „Panasonic Comfort Cloud“-App

Symptom	Lösung
Benutzer-ID kann nicht abgerufen werden	Aufgrund des Datenschutzgesetzes kann der „Panasonic Comfort Cloud“-Administrator Ihre Panasonic-ID nicht abrufen. Erstellen Sie eine neue Panasonic-ID.
Nach der Auswahl von „Forgot ID/password“ kann der E-Mail-Link für den Passwort-Reset nicht empfangen werden	Ihre E-Mail-Adresse ist möglicherweise falsch eingegeben worden. Wählen Sie erneut „Forgot ID/password“.
Abgemeldet, obwohl „Remember me“ ausgewählt ist.	<ul style="list-style-type: none"> <li>• Der Benutzer war mit dem Datenschutzhinweis nicht einverstanden.</li> <li>• Aufgrund des Datenschutzgesetzes werden Sie automatisch abgemeldet, wenn Sie 15 Tage lang nicht auf die „Panasonic Comfort Cloud“-App zugreifen.</li> <li>• Die „Panasonic Comfort Cloud“-App wurde in Ihrem Mobiltelefon geschlossen. Öffnen Sie die „Panasonic Comfort Cloud“-App erneut ohne Netzwerkverbindung.</li> <li>• Der „Panasonic Comfort Cloud“-Server wird derzeit gewartet oder aktualisiert.</li> <li>• Ihre Panasonic-ID wurde verwendet, um sich auf einem anderen Smartphone anzumelden. Sie können sich nur mit einer Panasonic-ID auf einem Smartphone anmelden.</li> <li>• Die „Panasonic Comfort Cloud“-Speicherdaten bzw. der Cache wurde geleert. Melden Sie sich erneut bei der „Panasonic Comfort Cloud“-App an.</li> </ul>
Das Innentemperatur-Symbol wird nicht angezeigt.	Das Innentemperatur-Symbol ist nur für Modelle mit dem neuesten Design anwendbar.
Einige Produktmerkmale wie HEAT, iAUTO-X, Luftschwingung (Links-Rechts) und Leistungsstark sind nicht verfügbar.	<p>Die Produktmerkmale werden entsprechend der Standardeinstellung jedes Landes angezeigt. Wählen Sie bei der Registrierung der Benutzer-ID das richtige Land aus.</p> <p>Der Anwendungsadministrator kann die Produktfunktionen für jede Klimaanlage in der Gruppe wie folgt aktivieren:</p>



Symptom	Lösung
<p>Der Wochentimer funktioniert nicht.</p>	<p>Prüfen Sie, ob Sie den Wochentimer in der „Panasonic Comfort Cloud“-App wie folgt eingeschaltet haben:</p>  <p>Prüfen Sie, ob es einen Konflikt zwischen dem Wochentimer und dem Fernbedienungstimer gibt. Der Anwendungsserver und die Fernbedienungszeit können unterschiedlich sein. Der Timer wird auf der Grundlage der früheren Zeit aktiviert. Überprüfen Sie, ob die Zeitzone wie folgt korrekt eingestellt ist:</p> 

## Sonstiges

Symptom	Lösung
<p>Austausch des Routers.</p>	<p>Wählen Sie in der „Panasonic Comfort Cloud“-App  aus. Wählen Sie „Owner“ und dann „Change router settings“ aus.</p>
<p>Änderung des Smartphone-Modells.</p>	<p>Prüfen Sie, ob Ihre Smartphoneversion kompatibel ist (Android 5.0 und höher oder iOS 9 und höher). Installieren Sie die „Panasonic Comfort Cloud“-App, und melden Sie sich mit Ihrer Panasonic Login-ID und Ihrem Passwort an. Befolgen Sie die Schritte für die Ersteinrichtung der Verbindung.</p>
<p>Austausch der Schalttafel des Innengeräts.</p>	<p>Ändern Sie die Schalttafel. Wählen Sie anschließend in der „Panasonic Comfort Cloud“-App  aus. Wählen Sie „Owner“ und dann „Replace device“ aus. Dies muss durch einen autorisierten Servicehändler erfolgen.</p>
<p>Änderung des Netzwerkadapters/WLAN-Moduls des Innengeräts.</p>	<p>Tauschen Sie den Netzwerkadapter/das WLAN-Modul aus. Wählen Sie anschließend in der „Panasonic Comfort Cloud“-App  aus. Wählen Sie „Owner“ und dann „Change router settings“ aus. Dies muss durch einen autorisierten Servicehändler erfolgen.</p>
<p>Transportieren oder Entsorgen der Klimaanlage.</p>	<p>Setzen Sie das Klimagerät auf die Werkseinstellungen zurück.</p> <ul style="list-style-type: none"> <li>• Vergewissern Sie sich, dass die WLAN-LED des Innengeräts leuchtet/blinkt, und drücken Sie 5 Sekunden lang die WLAN-Taste , bis auf der Fernbedienung „1“ angezeigt wird.</li> <li>• Drücken Sie die Taste , bis „5“ angezeigt wird.</li> <li>• Drücken Sie 3 Sekunden lang die -Taste, woraufhin der Betrieb stoppt.</li> <li>• Die WLAN-LED ist aus und das Rücksetzen auf Werkseinstellung ist abgeschlossen.</li> </ul> <p>Um die Registrierung des Klimageräts aus der „Panasonic Comfort Cloud“-App zu entfernen, wählen Sie  und dann „Device list“, um das Gerät zu löschen.</p>

# Störungssuche

Die nachfolgend aufgeführten Symptome sind kein Anzeichen für eine Fehlfunktion.

Symptom	Mögliche Ursache
WLAN-LED bleibt auch bei ausgeschaltetem Gerät EIN.	<ul style="list-style-type: none"><li>• WLAN-Verbindung des Gerätes mit dem Router ist aktiviert.</li></ul>
Die WLAN-LED blinkt ununterbrochen.	<ul style="list-style-type: none"><li>• WLAN-Verbindung des Gerätes mit dem Router ist nicht hergestellt. Überprüfen Sie Ihre Verbindung erneut.</li><li>• Wenn Sie die App nicht verwenden möchten, drücken Sie zum Ausschalten die WLAN-Taste .</li></ul>

## Informationen



### Konformitätserklärung (DOC)

Hiermit erklärt die „Panasonic Corporation“, dass dieses Produkt die maßgeblichen Anforderungen sowie andere relevante Bestimmungen der Richtlinie 2014/53/EU erfüllt.

Der vollständige Wortlaut der EU-Konformitätserklärung ist unter folgender Internetadresse abrufbar:  
<http://www.ptc.panasonic.eu/>

Bevollmächtigter Vertreter: Panasonic Testing Centre, Panasonic Marketing Europe GmbH,  
Winsbergring 15, 22525 Hamburg, Deutschl

Norwegen: Im Umkreis von 20 km um das Zentrum von Ny-Alesund auf Svalbard gibt es  
Nutzungsbeschränkungen.



# Informationen

**Die neuesten Informationen zur Software-Lizenz und zum Copyright zu diesem Produkt finden Sie im aktuellen Benutzerhandbuch auf unserer Website:**

[https://accsmart.panasonic.com/Manual/Built-In/en/manual\\_en.pdf](https://accsmart.panasonic.com/Manual/Built-In/en/manual_en.pdf)

## Firmware-Update-Funktion

Dieses Produkt verfügt über Funktionen zur Verbindung mit dem Panasonic Firmware- Update-Server über das Internet, um die Geräte-Firmware automatisch auf die neueste Version zu aktualisieren. Um die Firmware zu aktualisieren, prüft das Gerät einmal täglich, ob die Firmware nach dem Einschalten die neueste Version ist. Und wenn ein Update erforderlich ist, wird das Update durchgeführt und das Gerät startet automatisch neu. Während des Neustarts des Gerätes (Dauer ca. 1–5 Minuten) sind keine Operationen möglich.

## Informationen zur Software-Lizenz

Dieses Produkt enthält folgende Software:

- (1) unabhängig von oder für die Panasonic Corporation entwickelte Software,
  - (2) Software, die sich im Besitz von Dritten befindet und an die Panasonic Corporation lizenziert ist,
  - (3) Open-Source-Software unter der BSD-Lizenz und/oder gleichwertigen Lizenzen.
- Software, die unter (3) kategorisiert ist, wird in der Hoffnung vertrieben, dass sie von Nutzen ist; jedoch OHNE JEDE GARANTIE, also auch ohne implizite Garantie der MARKTGÄNGIGKEIT oder der EIGNUNG FÜR EINEN BESTIMMTEN ZWECK.

Die folgenden Lizenzbedingungen gelten für Open-Source-Komponenten.

### 1. Supplicant-Lizenz

Copyright (C) 2003-2016, Jouni Malinen <j@w1.fi > und Beitragsleistende.

Alle Rechte vorbehalten.

Diese Software darf unter den Bedingungen der BSD-Lizenz vertrieben, verwendet und modifiziert werden:

Die Weitergabe und Nutzung der Software im Quellcode- und Binärformat ist mit oder ohne Änderung nur gestattet, wenn die folgenden Bedingungen erfüllt sind:

1. Bei der Weitergabe des Quellcodes sind der oben genannte Copyright-Hinweis, die vorliegende Liste von Bedingungen sowie der folgende Haftungsausschluss hinzuzufügen.
2. Bei der Weitergabe im Binärformat sind der Dokumentation und/oder sonstigen Materialien, die beim Vertrieb bereitgestellt werden, der oben genannte Copyright-Hinweis, die vorliegende Liste von Bedingungen und der folgende Haftungsausschluss hinzuzufügen.
3. Weder der/die Name(n) des/der oben genannten Urheberrechtsinhaber noch der Name der Beitragsleistenden darf ohne vorherige schriftliche Zustimmung zur Werbung für Produkte verwendet werden, die von dieser Software abgeleitet werden.

DIESE SOFTWARE WIRD VON DEN URHEBERRECHTSINHABERN UND MITWIRKENDEN IM „IST-ZUSTAND“ BEREITGESTELLT; SÄMTLICHE AUSDRÜCKLICHEN ODER STILLSCHWEIGENDEN GEWÄHRLEISTUNGEN WERDEN AUSGESCHLOSSEN, EINSCHLIESSLICH, JEDOCH NICHT BESCHRÄNKT AUF STILLSCHWEIGENDE GEWÄHRLEISTUNGEN DER MARKTGÄNGIGKEIT UND EIGNUNG FÜR EINEN BESTIMMTEN ZWECK. DER AUTOR ODER DIE MITWIRKENDEN SIND IN KEINEM FALL FÜR DIREKTE, INDIREKTE, ZUFÄLLIGE, KONKRETE ODER EXEMPLARISCHE SCHÄDEN ODER FOLGESCHÄDEN HAFTBAR (EINSCHLIESSLICH, ABER NICHT BESCHRÄNKT AUF DIE BESCHAFFUNG VON ERSATZPRODUKTEN ODER -DIENSTEN, NUTZUNGSAusFALL, DATEN- UND GEWINNVERLUST ODER GESCHÄFTSAUSFALL), DIE AUFGRUND DER VERWENDUNG DIESER SOFTWARE ENTSTEHEN KÖNNEN, UND ZWAR AUCH DANN, WENN AUF DIE MÖGLICHKEIT SOLCHER SCHÄDEN HINGEWIESEN WURDE; DIES GILT UNABHÄNGIG DAVON, WIE DIESE SCHÄDEN ENTSTANDEN SIND UND AUS WELCHEM HAFTUNGSGRUND ANSPRÜCHE HERGELEITET WERDEN,, GLEICH OB VERTRAGSGEMÄSSE HAFTUNG, GEFÄHRDUNGSHAFTUNG ODER HAFTUNG AUS UNERLAUBTER HANDLUNG (INSBESONDERE FAHRLÄSSIGKEIT).

# Copyright<sup>①</sup>

- The App Store is a service mark of Apple Inc.
- iPhone is a trademark of Apple Inc. registered in the United States and other countries. The iPhone trademarks is used under license of iPhone Co., Ltd.
- Android and Google Play are trademarks or registered trademarks of Google LLC.
- Other names, company names, product names, etc described in this manual are trademarks or registered trademarks of each company. In the text, some <sup>TM</sup> and <sup>®</sup> marks are not listed.

## About Software

This product incorporates the following software:

- 1) The software developed independently by or for Panasonic Corporation,
- 2) The software owned by third party and licensed to Panasonic Corporation,
- 3) The software licensed under the GNU GENERAL PUBLIC LICENSE Version 2.0 (GPL V2.0),
- 4) Open sourced software other than the software licensed under the GPL V2.0.

The software categorized as (3) and (4) are distributed in the hope that it will be useful, but without any warranty, without even the implied warranty of [merchantability] or [fitness for a particular purpose].

Please refer to the detailed terms and conditions thereof shown in the "Software License" menu on this product.

At least three (3) years from delivery of this product, Panasonic will give to any third party who contacts us at the contact information provided below, for a charge no more than our cost of physically performing source code distribution, a complete machine-readable copy of the corresponding source code covered under GPL V2.0 or the other licenses with the obligation to do so, as well as the respective copyright notice thereof.

Contact information:

oss-cd-request@gg.jp.panasonic.com

The source code and the copyright notice are also available for free in our website below.

<https://panasonic.net/cns/oss/ap/>

## lwIP

lwIP is licenced under the BSD licence:

Copyright (c) 2001-2004 Swedish Institute of Computer Science.

All rights reserved.

Copyright (c) 2001-2003 Swedish Institute of Computer Science. All rights reserved.

Copyright (c) 2002 CITEL Technologies Ltd. All rights reserved.

Copyright (c) 2007 Dominik Spies <kontakt@dspies.de> All rights reserved.

Copyright (c) 2002-2003, Adam Dunkels. All rights reserved.

Copyright (c) 2001-2003 Swedish Institute of Computer Science.

Copyright (c) 2003-2004 Leon Woestenberg <leon.woestenberg@axon.tv>

Copyright (c) 2003-2004 Axon Digital Design B.V., The Netherlands.

All rights reserved.

Copyright (c) 2001-2004 Leon Woestenberg <leon.woestenberg@gmx.net>

Copyright (c) 2001-2004 Axon Digital Design B.V., The Netherlands.

All rights reserved.

Copyright (c) 2001-2004 Axon Digital Design B.V., The Netherlands.

All rights reserved.

Copyright (c) 2001-2004 Axon Digital Design B.V., The Netherlands.

All rights reserved.

## MINIX3

Copyright (c) 2016 The MINIX 3 Project.

All rights reserved.

Redistribution and use in source and binary forms, with or without modification, are permitted provided that the following conditions are met:

1. Redistributions of source code must retain the above copyright notice, this list of conditions and the following disclaimer.
2. Redistributions in binary form must reproduce the above copyright notice, this list of conditions and the following disclaimer in the documentation and/or other materials provided with the distribution.
3. The name of the author may not be used to endorse or promote products derived from this software without specific prior written permission.

THIS SOFTWARE IS PROVIDED BY THE AUTHOR "AS IS" AND ANY EXPRESS OR IMPLIED WARRANTIES, INCLUDING, BUT NOT LIMITED TO, THE IMPLIED WARRANTIES OF MERCHANTABILITY AND FITNESS FOR A PARTICULAR PURPOSE ARE DISCLAIMED. IN NO EVENT SHALL THE AUTHOR BE LIABLE FOR ANY DIRECT, INDIRECT, INCIDENTAL, SPECIAL, EXEMPLARY, OR CONSEQUENTIAL DAMAGES (INCLUDING, BUT NOT LIMITED TO, PROCUREMENT OF SUBSTITUTE GOODS OR SERVICES; LOSS OF USE, DATA, OR PROFITS; OR BUSINESS INTERRUPTION) HOWEVER CAUSED AND ON ANY THEORY OF LIABILITY, WHETHER IN CONTRACT, STRICT LIABILITY, OR TORT (INCLUDING NEGLIGENCE OR OTHERWISE) ARISING IN ANY WAY OUT OF THE USE OF THIS SOFTWARE, EVEN IF ADVISED OF THE POSSIBILITY OF SUCH DAMAGE.

## mbdTLS

Copyright (C) 2006-2015, ARM Limited, All Rights Reserved

Copyright (C) 2006-2016, ARM Limited, All Rights Reserved

Apache License

Version 2.0, January 2004

<http://www.apache.org/licenses/>

TERMS AND CONDITIONS FOR USE, REPRODUCTION, AND DISTRIBUTION

### 1. Definitions.

"License" shall mean the terms and conditions for use, reproduction, and distribution as defined by Sections 1 through 9 of this document.

"Licensor" shall mean the copyright owner or entity authorized by the copyright owner that is granting the License.

"Legal Entity" shall mean the union of the acting entity and all other entities that control, are controlled by, or are under common control with that entity. For the purposes of this definition, "control" means (i) the power, direct or indirect, to cause the direction or management of such entity, whether by contract or otherwise, or (ii) ownership of fifty percent (50%) or more of the outstanding shares, or (iii) beneficial ownership of such entity.

"You" (or "Your") shall mean an individual or Legal Entity exercising permissions granted by this License.

"Source" form shall mean the preferred form for making modifications, including but not limited to software source code, documentation source, and configuration files.

"Object" form shall mean any form resulting from mechanical transformation or translation of a Source form, including but not limited to compiled object code, generated documentation, and conversions to other media types.

"Work" shall mean the work of authorship, whether in Source or Object form, made available under the License, as indicated by a copyright notice that is included in or attached to the work.

"Derivative Works" shall mean any work, whether in Source or Object form, that is based on (or derived from) the Work and for which the editorial revisions, annotations, elaborations, or other modifications represent, as a whole, an original work of authorship. For the purposes of this License, Derivative Works shall not include works that remain separate from, or merely link (or bind by name) to the interfaces of, the Work and Derivative Works thereof.

"Contribution" shall mean any work of authorship, including the original version of the Work and any modifications or additions to that Work or Derivative Works thereof, that is intentionally submitted to Licensor for inclusion in the Work by the copyright owner or by an individual or Legal Entity authorized to submit on behalf of the copyright owner. For the purposes of this definition, "submitted" means any form of electronic, verbal, or written communication sent to the Licensor or its representatives, including but not limited to communication on electronic mailing lists, source code control systems, and issue tracking systems that are managed by, or on behalf of, the Licensor for the purpose of discussing and improving the Work, but excluding

communication that is conspicuously marked or otherwise designated in writing by the copyright owner as "Not a Contribution."

"Contributor" shall mean Licensor and any individual or Legal Entity on behalf of whom a Contribution has been received by Licensor and subsequently incorporated within the Work.

**2. Grant of Copyright License.** Subject to the terms and conditions of this License, each Contributor hereby grants to You a perpetual, worldwide, non-exclusive, no-charge, royalty-free, irrevocable copyright license to reproduce, prepare Derivative Works of, publicly display, publicly perform, sublicense, and distribute the Work and such Derivative Works in Source or Object form.

**3. Grant of Patent License.** Subject to the terms and conditions of this License, each Contributor hereby grants to You a perpetual, worldwide, non-exclusive, no-charge, royaltyfree, irrevocable (except as stated in this section) patent license to make, have made, use, offer to sell, sell, import, and otherwise transfer the Work, where such license applies only to those patent claims licensable by such Contributor that are necessarily infringed by their Contribution(s) alone or by combination of their Contribution(s) with the Work to which such Contribution(s) was submitted.

If You institute patent litigation against any entity (including a cross-claim or counterclaim in a lawsuit) alleging that the Work or a Contribution incorporated within the Work constitutes direct or contributory patent infringement, then any patent licenses granted to You under this License for that Work shall terminate as of the date such litigation is filed.

**4. Redistribution.** You may reproduce and distribute copies of the Work or Derivative Works thereof in any medium, with or without modifications, and in Source or Object form, provided that You meet the following conditions:

- (a) You must give any other recipients of the Work or Derivative Works a copy of this License; and
- (b) You must cause any modified files to carry prominent notices stating that You changed the files; and
- (c) You must retain, in the Source form of any Derivative Works that You distribute, all copyright, patent, trademark, and attribution notices from the Source form of the Work, excluding those notices that do not pertain to any part of the Derivative Works; and
- (d) If the Work includes a "NOTICE" text file as part of its distribution, then any Derivative Works that You distribute must include a readable copy of the attribution notices contained within such NOTICE file, excluding those notices that do not pertain to any part of the Derivative Works, in at least one of the following places: within a NOTICE text file distributed as part of the Derivative Works; within the Source form or documentation, if provided along with the Derivative Works; or, within a display generated by the Derivative Works, if and wherever such third-party notices normally appear. The contents of the NOTICE file are for informational purposes only and do not modify the License. You may add Your own attribution notices within Derivative Works that You distribute, alongside or as an addendum to the NOTICE text from the Work, provided that such additional attribution notices cannot be construed as modifying the License.

You may add Your own copyright statement to Your modifications and may provide additional or different license terms and conditions for use, reproduction, or distribution of Your modifications, or for any such Derivative Works as a whole, provided Your use, reproduction, and distribution of the Work otherwise complies with the conditions stated in this License.

**5. Submission of Contributions.** Unless You explicitly state otherwise, any Contribution intentionally submitted for inclusion in the Work by You to the Licensor shall be under the terms and conditions of this License, without any additional terms or conditions.

Notwithstanding the above, nothing herein shall supersede or modify the terms of any separate license agreement you may have executed with Licensor regarding such Contributions.

**6. Trademarks.** This License does not grant permission to use the trade names, trademarks, service marks, or product names of the Licensor, except as required for reasonable and customary use in describing the origin of the Work and reproducing the content of the NOTICE file.

**7. Disclaimer of Warranty.** Unless required by applicable law or agreed to in writing, Licensor provides the Work (and each Contributor provides its Contributions) on an "AS IS" BASIS, WITHOUT WARRANTIES OR CONDITIONS OF ANY KIND, either express or implied, including, without limitation, any warranties or conditions of TITLE, NON-INFRINGEMENT, MERCHANTABILITY, or FITNESS FOR A PARTICULAR PURPOSE. You are solely responsible for determining the appropriateness of using or redistributing the Work and assume any risks associated with Your exercise of permissions under this License.

**8. Limitation of Liability.** In no event and under no legal theory, whether in tort (including negligence), contract, or otherwise, unless required by applicable law (such as deliberate and grossly negligent acts) or agreed to in writing, shall any Contributor be liable to You for damages, including any direct, indirect, special, incidental, or consequential damages of any character arising as a result of this License or out of the use or inability to use the Work (including but not limited to damages for loss of goodwill, work stoppage, computer failure or malfunction, or any and all other commercial damages or losses), even if such Contributor has been advised of the possibility of such damages.

**9. Accepting Warranty or Additional Liability.** While redistributing the Work or Derivative Works thereof, You may choose to offer, and charge a fee for, acceptance of support, warranty, indemnity, or other liability obligations and/or rights consistent with this License. However, in accepting such obligations, You may act only on Your own behalf and/or on Your sole responsibility, not on behalf of any other Contributor, and only if You agree to indemnify, defend, and hold each Contributor harmless for any liability incurred by, or claims asserted against, such Contributor by reason of your accepting any such warranty or additional liability.

END OF TERMS AND CONDITIONS

APPENDIX: How to apply the Apache License to your work.

To apply the Apache License to your work, attach the following boilerplate notice, with the fields enclosed by brackets "[]" replaced with your own identifying information. (Don't include the brackets!) The text should be enclosed in the appropriate comment syntax for the file format. We also recommend that a file or class name and description of purpose be included on the same "printed page" as the copyright notice for easier identification within third-party archives.

Copyright [yyyy] [name of copyright owner]  
Licensed under the Apache License, Version 2.0 (the "License"); you may not use this file except in compliance with the License.

You may obtain a copy of the License at

<http://www.apache.org/licenses/LICENSE-2.0>

Unless required by applicable law or agreed to in writing, software distributed under the License is distributed on an "AS IS" BASIS, WITHOUT WARRANTIES OR CONDITIONS OF ANY KIND, either express or implied.

See the License for the specific language governing permissions and limitations under the License.

=====  
Copyright (c) 2003-2016, Jouni Malinen  
<j@w1.fi> and contributors All Rights Reserved.

This program is licensed under the BSD license (the one with advertisement clause removed).

If you are submitting changes to the project, please see CONTRIBUTIONS file for more instructions.

License  
-----

# Copyright<sup>2</sup>

This software may be distributed, used, and modified under the terms of BSD license:

Redistribution and use in source and binary forms, with or without modification, are permitted provided that the following conditions are met:

1. Redistributions of source code must retain the above copyright notice, this list of conditions and the following disclaimer.
2. Redistributions in binary form must reproduce the above copyright notice, this list of conditions and the following disclaimer in the documentation and/or other materials provided with the distribution.
3. Neither the name(s) of the above-listed copyright holder(s) nor the names of its contributors may be used to endorse or promote products derived from this software without specific prior written permission.

THIS SOFTWARE IS PROVIDED BY THE COPYRIGHT HOLDERS AND CONTRIBUTORS "AS IS" AND ANY EXPRESS OR IMPLIED WARRANTIES, INCLUDING, BUT NOT LIMITED TO, THE IMPLIED WARRANTIES OF MERCHANTABILITY AND FITNESS FOR A PARTICULAR PURPOSE ARE DISCLAIMED. IN NO EVENT SHALL THE COPYRIGHT OWNER OR CONTRIBUTORS BE LIABLE FOR ANY DIRECT, INDIRECT, INCIDENTAL, SPECIAL, EXEMPLARY, OR CONSEQUENTIAL DAMAGES (INCLUDING, BUT NOT LIMITED TO, PROCUREMENT OF SUBSTITUTE GOODS OR SERVICES; LOSS OF USE, DATA, OR PROFITS; OR BUSINESS INTERRUPTION) HOWEVER CAUSED AND ON ANY THEORY OF LIABILITY, WHETHER IN CONTRACT, STRICT LIABILITY, OR TORT (INCLUDING NEGLIGENCE OR OTHERWISE) ARISING IN ANY WAY OUT OF THE USE OF THIS SOFTWARE, EVEN IF ADVISED OF THE POSSIBILITY OF SUCH DAMAGE.

## Free RTOS

The FreeRTOS source code is licensed by a \*modified\* GNU General Public License (GPL). The modification is provided in the form of an exception.

NOTE: The modification to the GPL is included to allow you to distribute a combined work that includes FreeRTOS without being obliged to provide the source code for proprietary components outside of the FreeRTOS kernel.

The FreeRTOS GPL Exception Text:

Any FreeRTOS source code, whether modified or in its original release form, or whether in whole or in part, can only be distributed by you under the terms of the GNU General Public License plus this exception. An independent module is a module which is not derived from or based on FreeRTOS.

Clause 1:

Linking FreeRTOS statically or dynamically with other modules is making a combined work based on FreeRTOS. Thus, the terms and conditions of the GNU General Public License cover the whole combination.

As a special exception, the copyright holder of FreeRTOS gives you permission to link FreeRTOS with independent modules that communicate with FreeRTOS solely through the FreeRTOS API interface, regardless of the license terms of these independent modules, and to copy and distribute the resulting combined work under terms of your choice, provided that

- + Every copy of the combined work is accompanied by a written statement that details to the recipient the version of FreeRTOS used and an offer by yourself to provide the FreeRTOS source code (including any modifications you may have made) should the recipient request it.
- + The combined work is not itself an RTOS, scheduler, kernel or related product.
- + The independent modules add significant and primary functionality to FreeRTOS and do not merely extend the existing functionality already present in FreeRTOS.

Clause 2:

FreeRTOS may not be used for any competitive or comparative purpose, including the publication of any form of run time or compile time metric, without the express permission of Real Time Engineers Ltd. (this is the norm within the industry and is intended to ensure information accuracy).

The standard GPL exception text:

GNU GENERAL PUBLIC LICENSE  
Version 2, June 1991

Copyright (C) 1989, 1991 Free Software Foundation, Inc. 59 Temple Place, Suite 330, Boston, MA 02111-1307 USA  
Everyone is permitted to copy and distribute verbatim copies of this license document, but changing it is not allowed.

Preamble

The licenses for most software are designed to take away your freedom to share and change it. By contrast, the GNU General Public License is intended to guarantee your freedom to share and change free software—to make sure the software is free for all its users. This General Public License applies to most of the Free Software Foundation's software and to any other program whose authors commit to using it. (Some other Free Software Foundation software is covered by the GNU Library General Public License instead.) You can apply it to your programs, too.

When we speak of free software, we are referring to freedom, not price. Our General Public Licenses are designed to make sure that you have the freedom to distribute copies of free software (and charge for this service if you wish), that you receive source code or can get it if you want it, that you can change the software or use pieces of it in new free programs; and that you know you can do these things.

To protect your rights, we need to make restrictions that forbid anyone to deny you these rights or to ask you to surrender the rights. These restrictions translate to certain responsibilities for you if you distribute copies of the software, or if you modify it.

For example, if you distribute copies of such a program, whether gratis or for a fee, you must give the recipients all the rights that you have. You must make sure that they, too, receive or can get the source code. And you must show them these terms so they know their rights.

We protect your rights with two steps: (1) copyright the software, and (2) offer you this license which gives you legal permission to copy, distribute and/or modify the software.

Also, for each author's protection and ours, we want to make certain that everyone understands that there is no warranty for this free software. If the software is modified by someone else and passed on, we want its recipients to know that what they have is not the original, so that any problems introduced by others will not reflect on the original authors' reputations.

Finally, any free program is threatened constantly by software patents. We wish to avoid the danger that redistributors of a free program will individually obtain patent licenses, in effect making the program proprietary. To prevent this, we have made it clear that any patent must be licensed for everyone's free use or not licensed at all.

The precise terms and conditions for copying, distribution and modification follow.

GNU GENERAL PUBLIC LICENSE  
TERMS AND CONDITIONS FOR COPYING,  
DISTRIBUTION AND MODIFICATION

0. This License applies to any program or other work which contains a notice placed by the copyright holder saying it may be distributed under the terms of this General Public License. The "Program", below, refers to any such program or work, and a "work based on the Program" means either the Program or any derivative work under copyright law: that is to say, a work containing the Program or a portion

of it, either verbatim or with modifications and/or translated into another language. (Hereinafter, translation is included without limitation in the term "modification".) Each licensee is addressed as "you".

Activities other than copying, distribution and modification are not covered by this License; they are outside its scope. The act of running the Program is not restricted, and the output from the Program is covered only if its contents constitute a work based on the Program (independent of having been made by running the Program).

Whether that is true depends on what the Program does.

1. You may copy and distribute verbatim copies of the Program's source code as you receive it, in any medium, provided that you conspicuously and appropriately publish on each copy an appropriate copyright notice and disclaimer of warranty; keep intact all the notices that refer to this License and to the absence of any warranty; and give any other recipients of the Program a copy of this License along with the Program.

You may charge a fee for the physical act of transferring a copy, and you may at your option offer warranty protection in exchange for a fee.

2. You may modify your copy or copies of the Program or any portion of it, thus forming a work based on the Program, and copy and distribute such modifications or work under the terms of Section 1 above, provided that you also meet all of these conditions:

- a) You must cause the modified files to carry prominent notices stating that you changed the files and the date of any change.
- b) You must cause any work that you distribute or publish, that in whole or in part contains or is derived from the Program or any part thereof, to be licensed as a whole at no charge to all third parties under the terms of this License.
- c) If the modified program normally reads commands interactively when run, you must cause it, when started running for such interactive use in the most ordinary way, to print or display an announcement including an appropriate copyright notice and a notice that there is no warranty (or else, saying that you provide a warranty) and that users may redistribute the program under these conditions, and telling the user how to view a copy of this License. (Exception: if the Program itself is interactive but does not normally print such an announcement, your work based on the Program is not required to print an announcement.)

These requirements apply to the modified work as a whole. If identifiable sections of that work are not derived from the Program, and can be reasonably considered independent and separate works in themselves, then this License, and its terms, do not apply to those sections when you distribute them as separate works. But when you distribute the same sections as part of a whole which is a work based on the Program the distribution of the whole must be on the terms of this License, whose permissions for other licensees extend to the entire whole, and thus to each and every part regardless of who wrote it.

Thus, it is not the intent of this section to claim rights or contest your rights to work written entirely by you; rather, the intent is to exercise the right to control the distribution of derivative or collective works based on the Program.

In addition, mere aggregation of another work not based on the Program with the Program (or with a work based on the Program) on a volume of a storage or distribution medium does not bring the other work under the scope of this License.

3. You may copy and distribute the Program (or a work based on it, under Section 2) in object code or executable form under the terms of Sections 1 and 2 above provided that you also do one of the following:

- a) Accompany it with the complete corresponding machine-readable source code, which must be distributed under the terms of Sections 1 and 2 above on a medium customarily used for software interchange; or,
- b) Accompany it with a written offer, valid for at least three years,

to give any third party, for a charge no more than your cost of physically performing source distribution, a complete machine-readable copy of the corresponding source code, to be distributed under the terms of Sections 1 and 2 above on a medium customarily used for software interchange; or,

c) Accompany it with the information you received as to the offer to distribute corresponding source code. (This alternative is allowed only for noncommercial distribution and only if you received the program in object code or executable form with such an offer, in accord with Subsection b above.)

The source code for a work means the preferred form of the work for making modifications to it. For an executable work, complete source code means all the source code for all modules it contains, plus any associated interface definition files, plus the scripts used to control compilation and installation of the executable. However, as a special exception, the source code distributed need not include anything that is normally distributed (in either source or binary form) with the major components (compiler, kernel, and so on) of the operating system on which the executable runs, unless that component itself accompanies the executable.

If distribution of executable or object code is made by offering access to copy from a designated place, then offering equivalent access to copy the source code from the same place counts as distribution of the source code, even though third parties are not compelled to copy the source along with the object code.

4. You may not copy, modify, sublicense, or distribute the Program except as expressly provided under this License. Any attempt otherwise to copy, modify, sublicense or distribute the Program is void, and will automatically terminate your rights under this License. However, parties who have received copies, or rights, from you under this License will not have their licenses terminated so long as such parties remain in full compliance.

5. You are not required to accept this License, since you have not signed it. However, nothing else grants you permission to modify or distribute the Program or its derivative works. These actions are prohibited by law if you do not accept this License. Therefore, by modifying or distributing the Program (or any work based on the Program), you indicate your acceptance of this License to do so, and all its terms and conditions for copying, distributing or modifying the Program or works based on it.

6. Each time you redistribute the Program (or any work based on the Program), the recipient automatically receives a license from the original licensor to copy, distribute or modify the Program subject to these terms and conditions. You may not impose any further restrictions on the recipients' exercise of the rights granted herein. You are not responsible for enforcing compliance by third parties to this License.

7. If, as a consequence of a court judgment or allegation of patent infringement or for any other reason (not limited to patent issues), conditions are imposed on you (whether by court order, agreement or otherwise) that contradict the conditions of this License, they do not excuse you from the conditions of this License. If you cannot distribute so as to satisfy simultaneously your obligations under this License and any other pertinent obligations, then as a consequence you may not distribute the Program at all. For example, if a patent license would not permit royalty-free redistribution of the Program by all those who receive copies directly or indirectly through you, then the only way you could satisfy both it and this License would be to refrain entirely from distribution of the Program.

If any portion of this section is held invalid or unenforceable under any particular circumstance, the balance of the section is intended to apply and the section as a whole is intended to apply in other circumstances. It is not the purpose of this section to induce you to infringe any patents or other property right claims or to contest validity of any such claims; this section has the sole purpose of protecting the integrity of the free

# Copyright<sup>③</sup>

software distribution system, which is implemented by public license practices. Many people have made generous contributions to the wide range of software distributed through that system in reliance on consistent application of that system; it is up to the author/donor to decide if he or she is willing to distribute software through any other system and a licensee cannot impose that choice.

This section is intended to make thoroughly clear what is believed to be a consequence of the rest of this License.

8. If the distribution and/or use of the Program is restricted in certain countries either by patents or by copyrighted interfaces, the original copyright holder who places the Program under this License may add an explicit geographical distribution limitation excluding those countries, so that distribution is permitted only in or among countries not thus excluded. In such case, this License incorporates the limitation as if written in the body of this License.

9. The Free Software Foundation may publish revised and/or new versions of the General Public License from time to time. Such new versions will be similar in spirit to the present version, but may differ in detail to address new problems or concerns. Each version is given a distinguishing version number. If the Program specifies a version number of this License which applies to it and "any later version", you have the option of following the terms and conditions either of that version or of any later version published by the Free Software Foundation. If the Program does not specify a version number of this License, you may choose any version ever published by the Free Software Foundation.

10. If you wish to incorporate parts of the Program into other free programs whose distribution conditions are different, write to the author to ask for permission. For software which is copyrighted by the Free Software Foundation, write to the Free Software Foundation; we sometimes make exceptions for this. Our decision will be guided by the two goals of preserving the free status of all derivatives of our free software and of promoting the sharing and reuse of software generally.

## NO WARRANTY

11. BECAUSE THE PROGRAM IS LICENSED FREE OF CHARGE, THERE IS NO WARRANTY FOR THE PROGRAM, TO THE EXTENT PERMITTED BY APPLICABLE LAW. EXCEPT WHEN OTHERWISE STATED IN WRITING THE COPYRIGHT HOLDERS AND/OR OTHER PARTIES PROVIDE THE PROGRAM "AS IS" WITHOUT WARRANTY OF ANY KIND, EITHER EXPRESSED OR IMPLIED, INCLUDING, BUT NOT LIMITED TO, THE IMPLIED WARRANTIES OF MERCHANTABILITY AND FITNESS FOR A PARTICULAR PURPOSE. THE ENTIRE RISK AS TO THE QUALITY AND PERFORMANCE OF THE PROGRAM IS WITH YOU. SHOULD THE PROGRAM PROVE DEFECTIVE, YOU ASSUME THE COST OF ALL NECESSARY SERVICING, REPAIR OR CORRECTION.

12. IN NO EVENT UNLESS REQUIRED BY APPLICABLE LAW OR AGREED TO IN WRITING WILL ANY COPYRIGHT HOLDER, OR ANY OTHER PARTY WHO MAY MODIFY AND/OR REDISTRIBUTE THE PROGRAM AS PERMITTED ABOVE, BE LIABLE TO YOU FOR DAMAGES, INCLUDING ANY GENERAL, SPECIAL, INCIDENTAL OR CONSEQUENTIAL DAMAGES ARISING OUT OF THE USE OR INABILITY TO USE THE PROGRAM (INCLUDING BUT NOT LIMITED TO LOSS OF DATA OR DATA BEING RENDERED INACCURATE OR LOSSES SUSTAINED BY YOU OR THIRD PARTIES OR A FAILURE OF THE PROGRAM TO OPERATE WITH ANY OTHER PROGRAMS), EVEN IF SUCH HOLDER OR OTHER PARTY HAS BEEN ADVISED OF THE POSSIBILITY OF SUCH DAMAGES.

## END OF TERMS AND CONDITIONS

### How to Apply These Terms to Your New Programs

If you develop a new program, and you want it to be of the greatest possible use to the public, the best way to achieve this is to make it free software which everyone can redistribute and change under these terms.

To do so, attach the following notices to the program. It is safest to attach them to the start of each source file to most effectively convey the exclusion of warranty; and each file should have at least the "copyright" line and a pointer to where the full notice is found.

<one line to give the program's name and a brief idea of what it does.>

Copyright (C) <year> <name of author>

This program is free software; you can redistribute it and/or modify it under the terms of the GNU General Public License\*\* as published by the Free Software Foundation; either version 2 of the License, or (at your option) any later version.

This program is distributed in the hope that it will be useful, but WITHOUT ANY WARRANTY; without even the implied warranty of MERCHANTABILITY or FITNESS FOR A PARTICULAR PURPOSE. See the GNU General Public License for more details.

You should have received a copy of the GNU General Public License along with this program; if not, write to the Free Software Foundation, Inc., 59 Temple Place, Suite 330, Boston, MA 02111-1307 USA

Also add information on how to contact you by electronic and paper mail. If the program is interactive, make it output a short notice like this when it starts in an interactive mode:

```
Gnomovision version 69, Copyright (C) year name of author
Gnomovision comes with ABSOLUTELY NO WARRANTY; for
details type `show w'.
```

```
This is free software, and you are welcome to redistribute it
under certain conditions; type `show c' for details.
```

The hypothetical commands 'show w' and 'show c' should show the appropriate parts of the General Public License. Of course, the commands you use may be called something other than 'show w' and 'show c'; they could even be mouseclicks or menu items--whatever suits your program.

You should also get your employer (if you work as a programmer) or your school, if any, to sign a "copyright disclaimer" for the program, if necessary. Here is a sample; alter the names:

```
Yoyodyne, Inc., hereby disclaims all copyright interest in
the program 'Gnomovision' (which makes passes at compilers)
written by James Hacker.
```

```
<signature of Ty Coon>, 1 April 1989
Ty Coon, President of Vice
```

This General Public License does not permit incorporating your program into proprietary programs. If your program is a subroutine library, you may consider it more useful to permit linking proprietary applications with the library. If this is what you want to do, use the GNU Library General Public License instead of this License.



Manufactured by: Panasonic Corporation  
1006 Kadoma, Kadoma City, Osaka, Japan  
Importer for Europe: Panasonic Marketing Europe GmbH  
Panasonic Testing Centre  
Winsbergring 15, 22525 Hamburg, Germany

Website: <http://www.panasonic.com>

© Panasonic Corporation 2020

Printed in Malaysia



Authorised representative in EU  
Panasonic Testing Centre  
Panasonic Marketing Europe GmbH  
Winsbergring 15, 22525 Hamburg, Germany

**ACXF55-30281**  
FC1220-1