

--	--

First Edition (March 1983)

It is possible that this material may contain reference to, or information about, IBM products (machines and programs), programming, or services that are not announced in your country. Such references or information must not be construed to mean that IBM intends to announce such IBM products, programming, or services in your country.

Publications are not stocked at the address given below; requests for IBM publications should be made to your IBM representative or to the IBM branch office serving your locality.

A form for readers' comments is provided at the back of this publication. If the form has been removed, address comments to IBM Corporation, Department 52Q, Neighborhood Road, Kingston, N.Y. 12401. IBM may use or distribute any of the information you supply in any way it believes appropriate without incurring any obligations whatever. You may, of course, continue to use the information you supply.

Preface

This publication provides introductory, reference, operational, and error-recovery information relative to the functional and programming characteristics of the IBM 3290 Information Panel.

This manual is for system programmers, application programmers, and those who prepare operating procedures for end users.

Organization

This manual has six chapters and three appendixes:

- Chapter 1 contains introductory information.
- Chapter 2 gives the characteristics of the 3290.
- Chapter 3 describes functions that are unique to the 3290 and that are largely operator-controlled.
- Chapter 4 lists the 3270 data stream functions supported by the 3290. For a general description of the 3270 data stream functions, the reader is referred to the *IBM 3270 Information Display System Data Stream Programmer's Reference*, GA23-0059. Only those functions unique to the 3290 are described in this chapter.
- Chapter 5 describes the 3290 controls and indicators.
- Chapter 6 explains the functions of the keyboard and keypad keys.
- Appendix A contains examples of operator setup and screen management.
- Appendix B lists the 3290 error codes, with the probable causes and corrective actions.
- Appendix C defines setup level 3 error codes.

A Glossary, preceding the Index, defines terms used in this manual.

Companion Publications

It is assumed that the user is familiar with the 3270 data stream, its functions, and how to write programs using it. If not familiar with the 3270 data stream, the user should view the *IBM 3270 Information Display System Data Stream Programmer's Reference*, GA23-0059, before trying to use this manual. In any case, that publication should be available for reference.

It may also be necessary to refer to other IBM publications:

- *IBM 3270 Information Display System 3274 Control Unit Description and Programmer's Guide*, GA23-0061
- *IBM 3270 Information Display System Feature Description*, GA23-0113
- *IBM 3270 Information Display System Character Set Reference*, GA27-2837

- *IBM 3270 Information Display System 3274 Control Unit Planning, Setup, and Customizing Guide, GA27-2827 (for Configuration Support T)*
- *IBM 3270 Information Display System 3274 Customizing Guide, GA23-0065 (for Configuration Support D)*
- *IBM 3290 Information Panel Setup Instructions, GA23-0080*
- *IBM 3290 Information Panel Screen Management Form, GX27-0028*
- *IBM 3290 Information Panel Problem Analysis and Resolution, GA23-0125 (U.S.)*
- *IBM 3290 Information Panel Problem Determination, GA23-0126 (other countries)*
- *IBM 3270 Information Display System Data Stream Programmer's Reference, GA23-0059*
- *IBM 3270 Information Display System Buffer Address Codes, GA23-0057*

Contents

Chapter 1. Introduction	1-1
Chapter 2. Display Characteristics	2-1
Character Cell	2-2
Character Matrix	2-3
Screen Layout and Addressing	2-3
Chapter 3. 3290-Unique Functions	3-1
Multiple Interactive Screens Function	3-1
Customizing for the Multiple Interactive Screens Function	3-2
Logical-Terminal Definition Table	3-2
Logical-Terminal Set Defaults	3-5
Allowable Screen Divisions and Usable Area	3-5
Allowable Number of Logical Terminals	3-6
Logon	3-6
Multiple Copy Screens Function	3-6
Copy Screen Mode	3-6
Setup Functions	3-7
Setup Level 1	3-8
Setup Level 2	3-10
Setup Level 3	3-11
Logical-Terminal Screen Sizes and Character Cell Sizes	3-15
Logical-Terminal Screen Size (Non-SNA)	3-16
Logical-Terminal Screen Size (SNA)	3-16
Partition/Viewport Size	3-16
Character Cell Sizes	3-16
Zoom Function	3-17
Rule Function	3-17
Rule Function in Implicit Partition State	3-18
Rule Function in Explicit Partitioned State	3-18
Image Limit	3-18
Row/Column Indicator	3-19
Logical-Terminal Identifier	3-19
3290-Unique Aspects of the Local Copy Function	3-19
Row Suppression	3-20
Local Copy Initiation	3-20
Operator-Initiated Local Copy	3-21
Host-Initiated Local Copy	3-21
Host Contention with Operator-Initiated Local Copy	3-21
Printer PA Key Operation during Local Copy	3-23
Customizing for the Local Copy Function	3-23
Chapter 4. 3270 Data-Stream Functions	4-1
Interface Codes	4-1
Attributes	4-4
Field Attributes	4-4
Extended Field Attributes and Character Attributes	4-5
Attribute Type X'41' – Extended Highlighting	4-5
Attribute Type X'42' – Color	4-5
Attribute Type X'43' – Character Set Selection	4-5
Commands	4-6
3270 Data Stream Commands	4-6
Non-SNA Channel Commands	4-6
Write Control Character	4-7
3270 Data Stream Orders	4-7
Outbound 3270 Data Stream Structured Fields	4-9
Load Programmed Symbols Structured Field Format	4-10
Create Partition Structured Field Format	4-11
Activate Partition Structured Field Format	4-12
Destroy Partition Structured Field Format	4-13
Set Window Origin Structured Field Format	4-13
Set Reply Mode Structured Field Format	4-14
Reset Partition Structured Field Format	4-15
ERASE/RESET Structured Field Format	4-15
Outbound 3270DS Structured Field Format	4-16
Read Partition Structured Field Format	4-16

- Inbound 3270 Data Stream 4-17
- Inbound 3270 Data Stream for Partition 0 4-18
 - Short Read Format 4-18
 - Read Modified and Read Modified All Format 4-19
 - Read Buffer Format 4-20
 - Read Buffer Format in Field Reply Mode 4-20
 - Read Buffer Format in Extended Field and Character Mode 4-21
- Inbound Structured Fields 4-22
 - Inbound 3270DS Structured Field Format for Partitions 01 through 0F 4-22
 - Query Reply Structured Field 4-23
 - Usable Area Query Reply Structured Field Format 4-23
 - Partitions Query Reply Structured Field Format 4-24
 - Self-Defining Parameter 4-25
 - Character Sets Query Reply Structured Field Format 4-26
 - Character Sets Descriptor Format 4-27
 - Reply Modes Query Reply Structured Field Format 4-27
 - Color Query Reply Structured Field Format 4-28
 - Highlight Query Reply Structured Field Format 4-29
 - Implicit Partition Query Reply Structured Field Format 4-30
 - Implicit Partition Default and Alternate Screen Size 4-30
 - Character Cell Dimensions 4-30
 - Self-Defining Parameters 4-30
- Transmission of Buffer Addresses 4-31
 - Buffer Addresses 4-31
 - Example of Buffer Address Calculation 4-32
 - Transmission of a Buffer Address 4-32
 - Transmission of Buffer Address in 16-Bit Address Mode 4-32
 - Transmission of Buffer Address in 12/14-Bit Address Mode 4-32

Chapter 5. 3290 Controls and Indicators 5-1

- 3290 Controls 5-2
 - On/Off Switch 5-2
 - On Indicator 5-2
 - Security Keylock 5-3
 - Test Switch 5-3
 - Tilt Control Lever 5-4
 - Audible Alarm Control 5-4
- 3290 Indicators 5-5
 - Quick Reference 5-6
 - Readiness and System Connection 5-8
 - Online (Non-SNA) 5-8
 - Online (SNA) 5-8
 - Ready 5-8
 - Setup 5-8
 - Copy Screen 5-8
 - Test 5-8
 - System Operator 5-9
 - My Job 5-9
 - Unowned 5-9
 - Do Not Enter 5-9
 - Security Key 5-10
 - Machine Check 5-10
 - Communication Check 5-10
 - Printer Not Working 5-10
 - Printer Busy 5-11
 - Printer Very Busy 5-11
 - Program Check 5-11
 - What ? 5-12
 - Terminal Wait 5-12
 - Minus Function 5-12
 - Minus Function – Operator Unauthorized 5-12
 - Too Much Entered 5-13
 - Numeric Data Only 5-13
 - Invalid Dead-Key Combination (Canadian-Bilingual and French Keyboards Only) 5-13
 - Go Elsewhere 5-14
 - Partition Wait 5-14
 - System Lock 5-14
 - What Number 5-14
 - Operator Unauthorized 5-15

Communication Error Reminder	5-15
Communication Error Reminder	5-15
Programmed Symbol Selection	5-15
Programmed Symbol Set (A through F) (Field-Defined)	5-15
Nonloadable Character Set (Field Inherit)	5-15
Programmed Symbol Set (A through F) (Field Inherit)	5-16
Programmed Symbol Set (A through F) (Operator-Selected)	5-16
Character Selection	5-16
Alpha	5-16
Katakana	5-16
APL	5-16
Shift Selection	5-17
Numeric	5-17
Upshift	5-17
Highlight Selection	5-17
Normal (Field Inherit)	5-17
Blink (Field Inherit)	5-17
Reverse Video (Field Inherit)	5-18
Underscore (Field Inherit)	5-18
Blink (Operator-Selected)	5-18
Reverse Video (Operator-Selected)	5-18
Underscore (Operator-Selected)	5-18
Insert	5-19
Insert Mode	5-19
Printer Status	5-19
Assign Printer	5-19
Printer Assignment	5-19
Printer Failure	5-19
Printer Printing	5-19
What Printer	5-19
Image Limit	5-20
Image Limit	5-20
Logical-Terminal ID	5-20
Logical-Terminal ID	5-20
Row and Column Position	5-20
Row and Column Indicator	5-20

Chapter 6. 3290 Keyboard and Keypad 6-1

Keyboard	6-1
Keyboard Controls	6-3
Clicker Volume Control	6-3
Keyboard ID Switches	6-3
Keypad	6-4
Keyboard Key Functions	6-6
Left Control Keys	6-6
Attention Key	6-6
Clear Key	6-7
Clear Partition Key	6-7
Copy Key	6-8
Cursor Select Key	6-8
Erase to End of Field Key	6-8
Erase Input Key	6-9
ExSel Key	6-9
Ident Key	6-9
Print Key	6-10
Print Operation	6-10
Copy Screen Operation	6-11
Setup Key	6-11
System Request Key	6-12
Operating in an SNA Environment	6-12
Operating in a Non-SNA Environment	6-12
Test Key	6-12
Zoom Key	6-13
Right Control Keys	6-14
Backtab Key	6-14
Change Screen Key	6-15
Cursor Left and Cursor Right Keys	6-15
Cursor Up and Cursor Down Keys	6-15
Delete Character Key	6-15
Key	6-16

- Dup Key 6-16
- Field Mark Key 6-16
- Home Key 6-17
- Insert Mode Key 6-17
- Jump Partition Key 6-18
- Jump Screen Key 6-18
- Program Access (PA) Keys—PA1 through PA3 6-18
- Rule Key 6-19
- Scroll Forward and Backward Keys 6-19
- ◀▶ Keys 6-19
- Program Function Keys 6-20
- Alternate Cursor Key 6-20
- APL Key 6-20
- Blink Character (Highlighting) Key 6-21
- Clicker Key 6-21
- Cursor Blink Key 6-21
- Field Inherit Keys 6-22
 - Programmed Symbol Set Field Inherit 6-22
 - Highlighting Field Inherit 6-23
- Program Function (PF) Keys – PF 1 through PF 24 6-23
- Programmed Symbols (PS) Keys, PSA through PSF 6-24
- Reverse Video (Highlighting) Key 6-25
- Underscore (Highlighting) Key 6-25
- Data Keys 6-26
 - Alphabetic Keys 6-26
 - Alternate Shift Keys 6-27
 - APL Character Keys 6-27
 - Dead Keys (Canadian-Bilingual or French Keyboards Only) 6-28
 - Device Cancel Key 6-29
 - Enter Key 6-29
 - New Line Key 6-30
 - Numeric and Symbol and Punctuation Mark Keys 6-30
 - Reset Key 6-31
 - Spacebar 6-31
 - Tab Key 6-32
 - Backspace Key 6-32
 - Uppercase Shift and Uppercase Shift Lock 6-32

Appendix A. Examples of Setup and Screen Management A-1

- Example 1: Rule Function A-2
- Example 2: Multiple Interactive Screens A-3
- Example 3: Copy Screen A-5
- Example 4: Modifying Screen Characteristics A-7

Appendix B. Error Code Charts B-1

- Indications during Power-On Sequence (3274-Detected Errors) B-1
 - During Initiating of Downstream Load B-1
 - During Downstream Load B-2
- Indications during Operation B-2
 - 3274-Detected Machine Check Errors B-2
 - 3274-Detected Program Checks B-2
 - Communication Check Errors B-2
- 3290-Detected Machine Check Errors B-2
- Program Error Codes B-5

Appendix C. Setup Level 3 Error Codes C-1

Glossary X-1

Index X-3

Figures

- 2-1. 3290 Display Screen 2-1
- 2-2. Character Cells (9 x 15 Size) 2-2
- 2-3. 7 x 9 Character Matrix in 9 x 15 Character Cell 2-3
- 3-1. Screen Divisions 3-1
- 3-2. IBM-Supplied Logical-Terminal Definition Table 3-3
- 3-3. IBM-Supplied Default Logical-Terminal Sets 3-5
- 3-4. Allowable Screen Divisions for Given Usable Areas 3-5
- 3-5. Allowable Usable Areas for Programs Written for 3278 Models 2, 3, 4, and 5 3-5
- 3-6. Maximum Number of Logical Terminals 3-6
- 3-7. Setup Level 3 Display 3-12
- 3-8. Character Cell Sizes 3-15
- 3-9. Specification Options for Byte 24 of the Bind Command 3-16
- 3-10. Data Copied for Operator-Initiated Local Copy 3-21
- 3-11. Data Copied for Host-Initiated Local Copy 3-22
- 4-1. United States EBCDIC I/O Interface Code 4-2
- 4-2. EBCDIC Control Character I/O Codes 4-3
- 4-3. Field Attribute Character Bit Assignment 4-4
- 4-4. Write Control Character (WCC) Reset Actions 4-8
- 5-1. 3290 Controls 5-1
- 6-1. 104-Key Typewriter Keyboard Layout 6-2
- 6-2. APL Keyboard Layout 6-2
- 6-3. 3290 Keypad - Program Function Layout 6-4
- 6-4. 3290 Keypad - Calculator Layout 6-5
- A-1. IBM-Supplied Values for Logical-Terminal Set C A-8

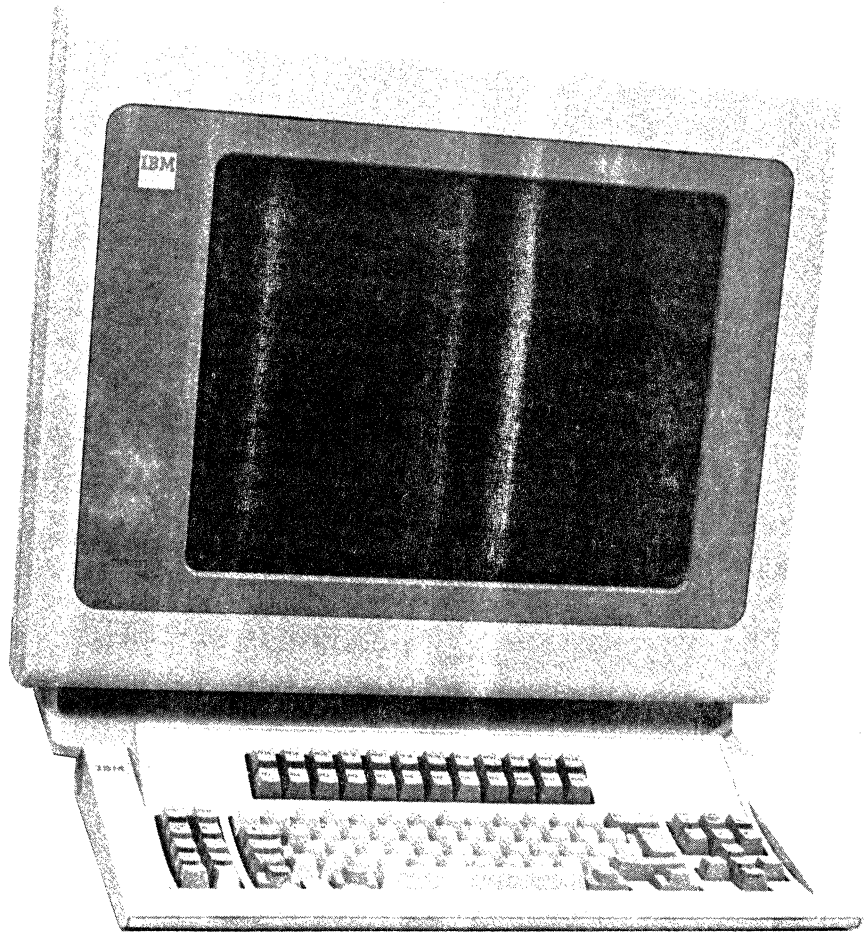

Frontispiece. IBM 3290 Information Panel

Chapter 1. Introduction

The IBM 3290 Information Panel (Frontispiece) uses the 3270 data stream as described in the *IBM 3270 Information Display System Data Stream Programmer's Reference*, GA23-0059. Refer to that publication for 3270 data stream information. This publication lists only the 3270 data stream functions supported by the 3290 and describes only those implementation differences that are unique to the 3290.

The 3290 interacts with host programs written for the 3270 displays. In terms of screen management facilities, keyboards, methods of highlighting, and peripheral device attachment, there are operational differences between the 3290 and other 3270 displays. See your IBM representative for any compatibility differences.

The 3290 supports the *multiple interactive screens* and *multiple copy screens* functions. These functions allow the operator to benefit from the larger 3290 screen, using existing 3270 host programs as well as new programs. The multiple interactive screens function allows the 3290 to operate as up to four logical displays, each interacting independently with its own host program. The multiple copy screens function allows the 3290 operator to initiate a copy of the active screen to one of up to three copy screens and to retain the copies for reference.

With new or modified 3270 host programs, the 3290 displays large screens (up to 9920 characters), and multiple (up to 16) partitions, with or without vertical scrolling. The 3290 interacts with structured-field data-stream functions. Although a monochromatic display, the 3290 accepts the structured-field (color) codes and returns them unchanged on a subsequent read operation.

The 3290 operates in the systems network architecture (SNA) and non-SNA environments. For SNA support, virtual telecommunications access method (VTAM) must be Advanced Communication Function (ACF)/VTAM, Release 1 or later, and telecommunications access method (TCAM) must be Version 2, Release 3 or later. In the SNA environment, the 3290 is a logical unit (LU) type 2 device, attached to a physical unit (PU) type 2 control unit. In a binary synchronous communication (BSC) environment, transparency must be used with structured fields or with extended attributes.

The 3290 can be attached to the IBM 3274 Control Unit. (See the *IBM 3270 Information Display System Feature Description*, GA23-0113, for the 3274 models to which the 3290 can be attached and for the necessary 3274 features and support.) When attached to the 3274 Control Unit, the 3290 is a Category A terminal that attaches to a type A port (except port A0).

Certain 3290-unique information is stored on the 3290 load diskette in the 3274 unit. This diskette must be placed in the 3274 diskette drive when any attached 3290s are to be used, because each time an attached 3290 is switched on (and at other times mentioned in this manual) the 3274 must provide a downstream load of this information from the diskette to the 3290.

The 3274 monitors and controls communication between the attached 3290s and the host system. See the *IBM 3270 Information Display System 3274 Control Unit Description and Programmer's Guide*, GA23-0061, for local operations, remote BSC operations, and SNA/synchronous data link control (SDLC) communication.

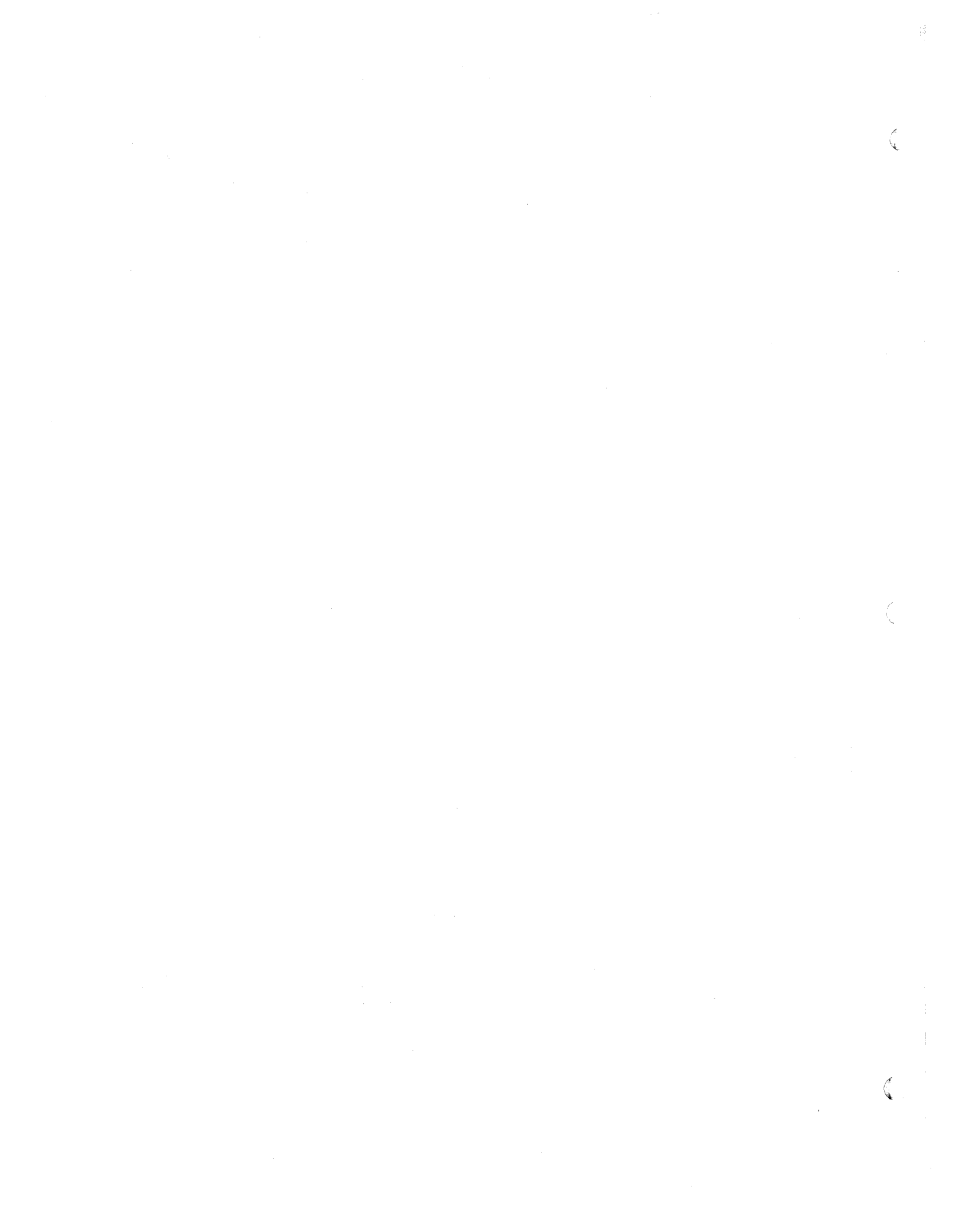

Chapter 2. Display Characteristics

The display element of the 3290 includes a plasma panel as a display screen. The display space of the screen permits the display of individual picture elements (PELs) in a contiguous matrix of 960 PELs in the horizontal direction and 751 PELs in the vertical direction. The display space is the area above the separator line for the operator information area. (See Figure 2-1.) The contiguous matrix permits the size, spacing, and location of alphanumeric text and programmed symbol (PS) characters to be varied in both the horizontal and vertical directions. Up to 62 rows of 160 columns are displayed in the display space, for a maximum of 9920 characters.

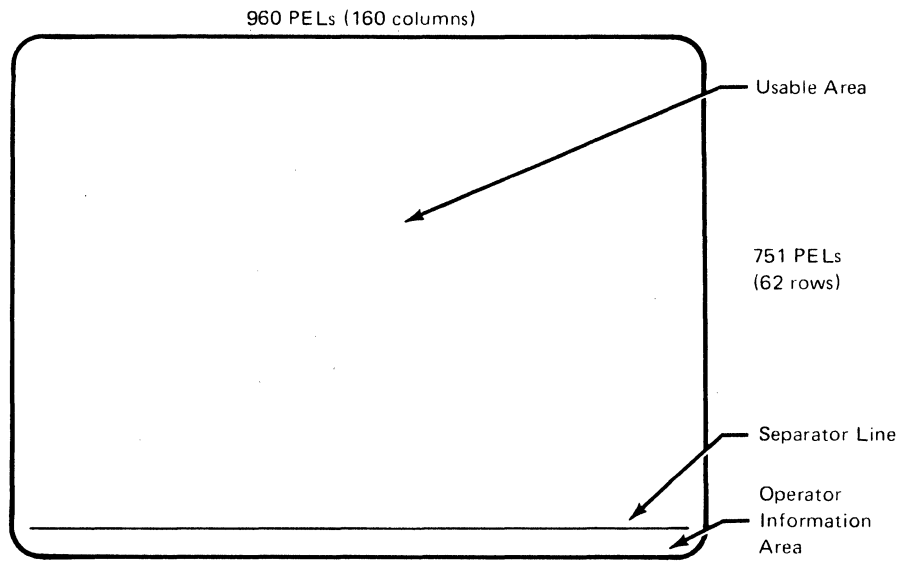

Figure 2-1. 3290 Display Screen

Character Cell

A character cell is a rectangular array of PELs, in the display space, that represents the maximum physical boundary for a single character. Whatever character cell size is used, the character cells are contiguous both horizontally and vertically on the 3290 screen.

Allowable character cell sizes range from 6 x 12 to 12 x 31 PELs. See Figure 2-2 for an example of an allowable size. How the character cell sizes are determined under various conditions is described in Chapter 3.

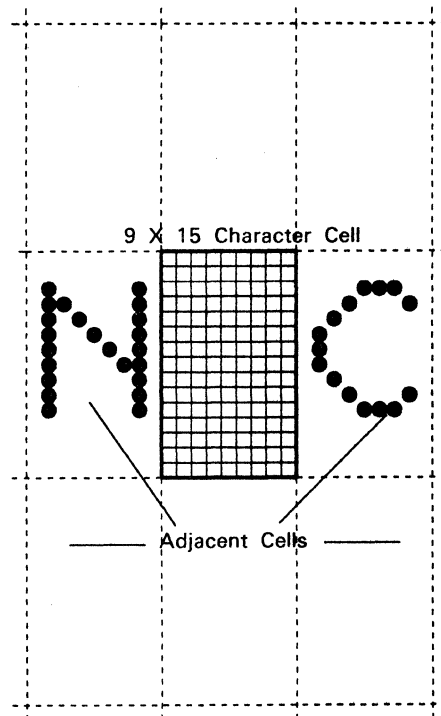

Figure 2-2. Character Cells (9 x 15 Size)

Character Matrix

A character matrix is a rectangular array of PELs that represents the minimum rectangular matrix necessary to display the uppercase E character for a given character set. The character matrixes for the two 3290 character sets are 5 x 8 and 7 x 9.

The 7 x 9 character set is used in character cells whose width is greater than or equal to 9, and whose height is greater than or equal to 15 (see Figure 2-3). The 5 x 8 character set is used in character cells smaller than 9 x 15.

9 x 15 Character Cell

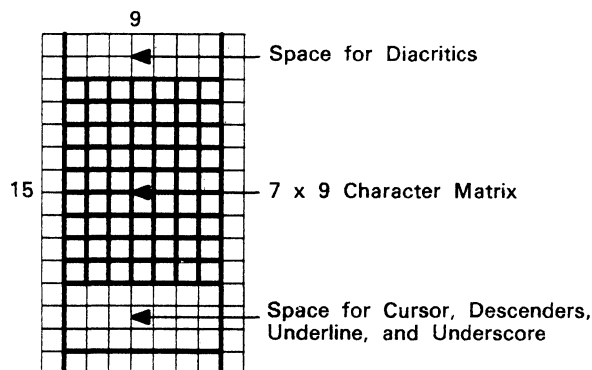

Figure 2-3. 7 x 9 Character Matrix in 9 x 15 Character Cell

Because the character cells are contiguous on the display screen, the size relationship between the character matrix and the character cell determines the vertical and horizontal spacing between characters. Characters can be densely packed or opened up for greater legibility through the proper choice of character cell size and character matrix size.

The allowable combinations of character cell size and character matrix size allow one or more PEL rows above the character matrix for the diacritics associated with some national languages, and one or more PEL rows beneath the character matrix for the cursor, for an underline, for an underscore, and for the descenders of certain lowercase alphabetic characters. Figure 2-3 illustrates a 7 x 9 character matrix within a 9 x 15 character cell, and shows the intercharacter spacing and the allowance for diacritics, descenders, etc.

Screen Layout and Addressing

Regardless of the sizes of the character cell and character matrix, character locations on the screen are addressed by buffer displacement, starting with 0,0 in the upper left of the screen area involved. See the *IBM 3290 Information Panel Screen Management Form*, GX27-0028. See Chapter 4 for a discussion of how to determine buffer addresses.

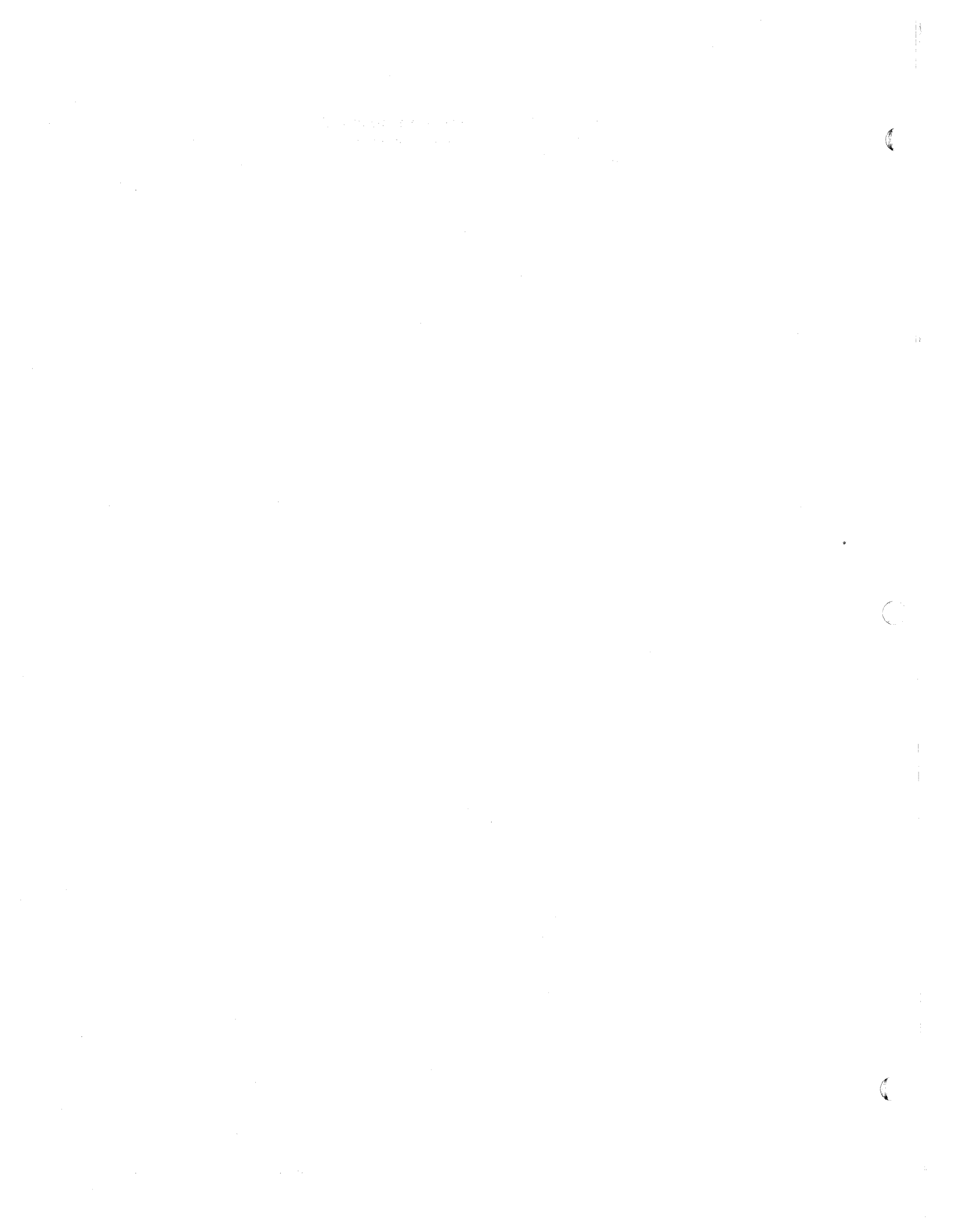

Chapter 3. 3290-Unique Functions

This chapter describes those functions that are unique to the 3290:

- Multiple interactive screens
- Multiple copy screens
- Setup
- Zoom
- Rule
- Image limit
- Row/column indicator
- Logical-terminal identifier
- 3290-unique aspects of the local copy function

These functions are largely operator-controlled.

Multiple Interactive Screens Function

The *multiple interactive screens* function provides the capability of using the 3290 as up to four co-resident interactive logical terminals. Each logical terminal can interact independently with its own host application program. To make use of this capability, the proper number of logical-terminal addresses must have been customized for the port to which the 3290 is attached. (See "Customizing for the Multiple Interactive Screens Function.")

When the multiple interactive screens function is used, the display space (above the separator line) can be undivided, divided into equal halves vertically or horizontally, or divided into equal quarters, as in Figure 3-1.

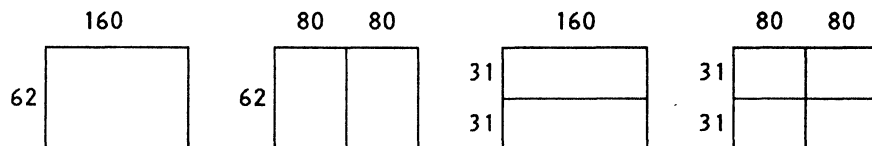

Note: The numbers shown indicate the dimensions of the screen areas in characters (assuming a 6 X 12 character cell size).

Figure 3-1. Screen Divisions

Each of these screen areas can contain a logical screen that displays the data associated with a logical terminal.

The logical screen containing the cursor is the active logical screen and accepts operator input. The keyboard and the symbols in the operator information area relate to the active logical screen. Only one logical screen can be the active logical screen. If more than one logical screen is displayed, the operator can make another logical screen the active logical screen by pressing the Jump Screen key. (When only one logical screen is displayed, the Jump Screen key has no effect.) The cursor moves from the current cursor position of the logical screen currently active to the current cursor position of the next clockwise logical screen, which then becomes the new active logical screen. The host programs interact with the logical screen for any defined logical terminal, whether it is active or inactive. It is possible for the logical screen associated with a logical terminal not to be physically displayed. At least one logical screen must always be displayed. The

operator specifies which logical terminals will have their logical screens displayed. (Refer to "Setup Mode".) A logical screen that is not displayed is placed in the background queue.

When a logical screen is placed in the background queue, the host can still interact with its logical terminal; but, for the operator to see the logical screen or to interact with it, the logical screen must be displayed as a foreground screen. This is accomplished by pressing the Change Screen (Chg Sc) key. If no background logical screen exists, the Change Screen key has no effect. Each time the Change Screen key is pressed, the active logical screen is placed at the bottom of the background queue and the top logical screen from the background queue is displayed as a foreground screen in its place.

Customizing for the Multiple Interactive Screens Function

See the *IBM 3270 Information Display System 3274 Control Unit Planning, Setup, and Customizing Guide*, GA27-2827 (Configuration Support T), or the *IBM 3270 Information Display System 3274 Control Unit Customizing Guide*, GA23-0065 (Configuration Support D). 3290s can be attached to any type A ports except port A0 (only a 3278 or 3279 can be attached to port A0).

For non-SNA 3274s, the maximum allowable number of logical-terminal addresses is 31. For SNA 3274s, the maximum allowable number of logical-terminal addresses is 128.

It is expected that users will customize three or five logical-terminal addresses when existing programs (smaller screens) are to be intermixed with a new program using a large screen. Those using only existing programs will probably customize two or four logical-terminal addresses.

Logical-Terminal Definition Table

The logical-terminal definition table (Figure 3-2) is supplied by IBM as a part of 3290 support. The table is downstream-loaded to the 3290 (from the load diskette placed in the 3274 diskette drive) whenever it is powered on and at other times, as described later.

The logical-terminal definition table defines six labeled logical-terminal sets (A, B, C, D, E, and F), each having provision for four logical-terminal definitions. Each logical-terminal definition can differ from the definitions for the other logical terminals, but the sum of the resources allocated to any logical-terminal set cannot exceed the resources available to the physical 3290.







The contents of the IBM-supplied logical-terminal definition table can be modified, either temporarily, for this 3290, or permanently (with the use of a password), for all attached 3290s. (See "Setup Level 3" for an explanation.) The contents of the logical-terminal definition table must meet the criteria specified in the text that follows Figure 3-2.

Logical-Terminal Set Label	Alt Screen Size	Char. Cell Size	Extended Attributes	PS	No. of Partitions	Scroll Enable	Num Lck	Logical-Terminal ID
	1	2	3	4	5	6	7	8
A	24x080	06x15	1	6	08	1	0	LT-1
	24x080	00x00	1	0	08	1	0	LT-2
	24x080	00x00	1	0	00	0	0	LT-3
	24x080	00x00	1	0	00	0	0	LT-4
B	31x160	00x00	0	0	08	1	0	LT-1
	31x160	00x00	0	0	08	1	0	LT-2
	31x160	00x00	0	0	00	0	0	LT-3
	00x000	00x00	0	0	00	0	0	
C	62x160	06x12	1	6	16	1	0	LT-1
	00x000	00x00	0	0	00	0	0	
	00x000	00x00	0	0	00	0	0	
	00x000	00x00	0	0	00	0	0	
D	32x080	00x00	1	6	08	1	0	LT-1
	32x080	00x00	1	0	08	1	0	LT-2
	00x000	00x00	0	0	00	0	0	
	00x000	00x00	0	0	00	0	0	
E	24x080	09x15	1	6	08	1	0	LT-1
	24x080	00x00	1	0	00	0	0	LT-2
	27x132	00x00	1	0	08	1	0	LT-3
	00x000	00x00	0	0	00	0	0	
F	43x080	00x00	1	6	08	1	0	LT-1
	43x080	00x00	1	0	08	1	0	LT-2
	00x000	00x00	0	0	00	0	0	
	00x000	00x00	0	0	00	0	0	

Figure 3-2. IBM-Supplied Logical-Terminal Definition Table

Following is an explanation of the contents of each column of this table and of the criteria that apply when the contents are modified.

Logical-Terminal Set Label (A, B, C, D, E, and F). Each logical-terminal set is associated with a default screen division and usable area. The usable area is the amount of display space allocated to a logical screen. The usable area specified determines which screen divisions are allowed. The IBM-supplied defaults for both usable area and screen division are as follows:

- A  Quarter screen
- B  Horizontal half
- C  Full screen
- D  Vertical half
- E  Horizontal half
- F  Vertical half

Column 1. Alternate (logical) screen size in rows and columns (RxC) for each logical terminal (00x000 = logical terminal not defined). Logical terminal 1 must be defined. Other logical terminals must be defined contiguously within a logical-terminal set: logical terminal 3 cannot be defined unless logical terminal 2 is defined, etc. In addition, both the default screen size and the defined alternate screen size, using the defined cell size, must be containable within the usable area available to the logical terminal.

Column 2. Character cell size in horizontal and vertical picture elements (PELs). 00x00 = cell size not defined. If not defined, the cell size is variable and is selected by the 3290 for optimum viewing in terms of character and row spacing. If defined, cell size must not be smaller than 06x12 or larger than 12x31. In addition, both the default screen size and the defined alternate screen size, using the defined cell size, must be containable within the usable area available to the logical terminal.

Column 3. Extended attributes enabled? (1 = yes; 0 = no.) Must be set to 1 for the APL-Text character set, programmed symbols, and extended highlighting.

Column 4. The number of programmed symbol (PS) sets configured (must be 6 or 0; cannot be 6 unless column 3 is 1). The six PS sets can be assigned to only one logical terminal in a logical-terminal set.

Column 5. Maximum number of partitions allowed for this logical terminal (must be 0, 8, or 16). The total number of partitions allowed cannot exceed 16 for a logical-terminal set.

Column 6. Scroll enabled? (1 = yes; 0 = no; cannot be 1 unless column 5 specifies either 8 or 16 partitions for this logical terminal.) If column 6 is 0, Create Partition commands specifying a partition with a viewport smaller than the presentation space for this logical terminal are rejected. See the *IBM 3270 Information Display System Data Stream Programmer's Reference*, GA23-0059, for descriptions of partitioning and scrolling.

Column 7. Numeric lock function active? (1 = yes; 0 = no.)

Column 8. An ID of up to 4 characters can be assigned to each logical terminal. The IBM-supplied IDs are shown, but the operator can enter any ID desired. A logical terminal may be defined without an identifier (blanks).

Logical-Terminal Set Defaults

The default logical-terminal set used by the 3290 is determined by the number of logical-terminal addresses customized for the 3274 port. (See Figure 3-3.) These defaults can be modified in setup mode.

Logical-Terminal Addresses Customized	IBM-Supplied Default Logical-Terminal Set
1	C
2	D
3	F
4	A
5	E

Figure 3-3. IBM-Supplied Default Logical-Terminal Sets

Allowable Screen Divisions and Usable Area

The allowable screen divisions for each logical-terminal set are determined by the usable area defined for the logical-terminal set. (See Figure 3-4.) Both the default and defined alternate screen sizes using the defined character cell size must be containable within the usable area specified for the logical terminal. (See Figure 3-5.)

Usable Area	Screen Divisions Allowed
1. Full Screen	
2. Horizontal Half-Screen	
3. Vertical Half-Screen	
4. Quarter Screen	

Figure 3-4. Allowable Screen Divisions for Given Usable Areas

3278		3290 Usable Area			
Model	Screen Size	62 x 160	31 x 160	62 x 80	31 x 80
2	24 X 80	Yes	Yes	Yes	Yes
3	32 X 80	Yes	No	Yes	No
4	43 X 80	Yes	No	Yes	No
5	27 X 132	Yes	Yes	No	No

Note: Size shown assumes 6 x 12 character size.

Figure 3-5. Allowable Usable Areas for Programs Written for 3278 Models 2, 3, 4, and 5

Allowable Number of Logical Terminals

The maximum number of logical terminals that can be defined in the selected logical-terminal set is determined by the number of logical-terminal addresses customized for the 3274 port. (See Figure 3-6.)

Logical-Terminal Addresses Customized	Maximum Number of Logical Terminals Defined in Set
1	1
2	2
3	2
4	4
5	4

Figure 3-6. Maximum Number of Logical Terminals

Logon

For each logical terminal that is to be used, the operator must log on as though it were an individual physical terminal.

Multiple Copy Screens Function

The *multiple copy screens* function allows the operator to designate from one to three copy screens into which the contents of logical screens can be copied for future reference. At least one logical screen must be present. The operator can clear a copy screen or copy a logical screen to a copy screen. However, the host cannot interact with a copy screen; nor can the operator interact with it other than to clear it or to copy over it. The copy screen is maintained on the display surface, but does not have a buffer. Therefore, if a copy screen is cleared for any reason, it can be restored only by another copy operation. Under certain conditions, the display space can be divided into more screens than can be used by the number of defined logical terminals in the selected logical-terminal set. These "extra" screens are copy screens. Furthermore, as long as the display space is divided into more than one screen, all but one logical screen can be designated as copy screens. (Refer to "Setup Function".) Any logical terminals that are defined but not displayed are placed in the background queue.

Copy Screen Mode

To copy the active logical screen to a copy screen or to a printer attached to the same 3274 Control Unit, or to clear a copy screen, the 3290 must enter *copy screen* mode. Pressing the Print (\square) key causes the 3290 alternately to enter and to exit copy screen mode. When the 3290 enters copy screen mode, the cursor moves from the active logical screen to the operator information area, and the copy screen mode indicator (\square) appears. In addition, certain symbols appear in the operator information area that indicate the screen division and screen designations (screens are designated as either copy screens or logical screens) in effect when the 3290 entered copy screen mode. These symbols may be selected by the operator to determine the destination of the copy operation. While the 3290 is in copy screen mode, only the Cursor Select, Clear, Print (\square), Shift and Shift Lock, Reset, and Horizontal Cursor Move (\leftarrow \rightarrow) keys are effective. (Other keys have no effect.)

When the 3290 is in copy screen mode, the symbols (from left to right) in the operator information area are as follows:

□→? □→□ □→□ ☒ ☒ □→□

Where:

□→? the leftmost symbol indicates that the 3290 is in copy screen mode.

□→□ is the print symbol.

□→□ or ☒ represents the designation (□→□ copy screen; ☒, logical screen) of the first screen area, starting with the upper-left screen area and proceeding clockwise.

If the operator moves the cursor under the print symbol and presses Cursor Select, the contents of the active partition (explicit partitioned state) or of the active logical screen (the one that contained the cursor before the Print key was pressed) are printed on the appropriate printer. This action causes the 3290 to exit copy screen mode. For more information, refer to "Print Key" in Chapter 6.

If the operator moves the cursor under a copy screen symbol and presses Cursor Select, the contents of the active logical screen are copied into the corresponding copy screen. Refer to "Setup Function" to create copy screens if none exist. If, instead of pressing Cursor Select, the operator presses Clear, the corresponding copy screen is cleared. The Xs in the logical screen symbols indicate that the operator cannot select the logical screens.

The operator can exit copy screen mode by pressing the Print key again. The copy screen mode (□→?) indicator is removed, and the associated symbols disappear from the operator information area; the cursor returns to the current cursor position in the active logical screen, and all keys are effective again.

Setup Functions

When the Setup key is pressed and the 3290 is not in setup mode, the 3290 enters setup mode and invokes setup level 1. Setup level 2 can be entered only from setup level 1, and setup level 3 can be entered only from setup level 2. While the 3290 is in setup mode, pressing the Setup key causes the 3290 to exit setup mode.

When the 3290 is switched on, information (including the contents of the logical-terminal definition table) is downstream-loaded from the 3290 load diskette, in the 3274 diskette drive. Some of this information determines the initial setup of the 3290.

When the 3290 is in setup mode, the operator can modify some setup values to other allowable values. Except as stated under "Setup Level 3," all modifications made in setup mode are temporary.

Temporary modifications do not modify the values on the 3290 load diskette. Therefore, temporary modifications affect only the 3290 at which the modifications were made, and the modified values persist only until the 3290 is switched off or the 3274 is reloaded. The next time the 3290 is switched on or the 3274 reloaded, the 3290 load-diskette values are downstream-loaded.

Permanent modifications are allowed only in setup level 3. Permanent modifications require the use of a password and change the values on the 3290 load diskette. Therefore, not only do permanent modifications affect the 3290 where the modifications were made, but, when other 3290s attached to the same 3274 are switched on, they are downstream-loaded with the modified values.

When the 3290 enters setup level 3, any modifications that were made under setup level 2 are canceled. Therefore, if it is necessary to enter setup level 3, any setup level 2 modifications should be done after the 3290 exits setup level 3.

Setup Level 1

To enter setup level 1, press Setup while holding down either Alt key.

When the 3290 enters setup level 1, the operator information area displays screen division symbols, screen designators, the monospace (AA) or dual-case (Aa) symbol, the copy-viewport (LV) or copy-presentation-space (LP) symbol, and the rule-line-follows-the-cursor (RC) or rule-line-does not-follow-the-cursor (RN) symbol. The cursor moves from the active logical screen to the operator information area. While the 3290 is in setup level 1, only the Setup, Cursor Select, Backspace, Shift, Shiftlock, Reset, and Horizontal Cursor Move keys are effective. (Other keys have no effect.) All modifications made under setup level 1 take effect immediately, except changes to screen designators, which take effect when the 3290 exits setup level 1. An example of the contents of the operator information area is shown below:

<1> □ ▬ □ ▧ LT-3 LT-1 LT-4 LT-2 AA LV RC ◇

Where:

<1>

Indicates that the 3290 is in setup level 1. All symbols in the operator information area apply to the current logical-terminal set.

(Cursor)

The cursor can be moved left or right within the operator information area to select the functions depicted in those columns. The cursor moves from one symbol position to the next and wraps around. It will never enter a column to the left of its initial position.

□ ▬ □ ▧

The allowed screen division symbol(s) for the selected logical-terminal set is (are) displayed. The symbol for the screen division currently in effect appears in reverse video.

If the cursor is moved (by use of the Horizontal Cursor Move keys) under another screen division symbol and the Cursor Select key is pressed, this new screen division takes effect and its symbol is displayed in reverse video. The screen designators may also change.

LT-3 LT-1 LT-4 LT-2

Each screen, starting at the top-left screen and proceeding clockwise, is represented by a screen designator, which may be a blank, a logical-terminal identifier, or a symbol (□→□). The symbol (□→□) designates this screen as a copy screen; a blank or a logical-terminal identifier designates the screen as a logical screen. To change the way a screen is used, position the cursor under its screen designator, and press the Cursor Select key. Each time the Cursor Select key is pressed, the screen designator changes to □→□, a blank, or the ID of one of the logical terminals defined for the logical-terminal set. Before the 3290 can exit setup level 1, the following conditions must exist and be verified:

- At least one logical screen must be displayed.
- The same logical screen cannot be displayed in more than one screen area.

If the operator attempts to exit setup level 1 and these conditions are not met, setup level 1 is not exited, a screen designator is displayed in reverse video, and the cursor is positioned under this designator.

AA or Aa

The monospace (AA) or the dual-case (Aa) symbol indicates the current mode of the 3290. The power-on default is the dual-case mode. If the cursor is moved under the displayed symbol and the Cursor Select key is pressed, the mode changes and the symbol for the new mode is displayed.

LV or LP

The copy-viewport (LV) or copy-presentation space (LP) symbol indicates the option currently in use by the 3290 for operator-initiated local-copy operations. If the cursor is moved under the displayed symbol and the Cursor Select key is pressed, the option changes and the symbol for the new option is displayed.

RC or RN

The rule-line-follows-the-cursor (RC) or rule-line-does-not-follow-the-cursor (RN) symbol indicates the current status of the 3290. (See the explanation of the Rule function.) If the cursor is moved under the displayed symbol and the Cursor Select key is pressed, the status changes and the symbol for the new status is displayed.



The diamond, displayed at the right of the setup level 1 display, allows the operator to select setup level 2 by moving the cursor under the diamond and pressing the Cursor Select key.

To exit setup level 1, either (1) select setup level 2 or (2) press Setup while holding down either Alt key.

Setup Level 2

When the 3290 enters setup level 2, the contents of the operator information area change to display the allowable logical-terminal set labels (A , B , C , D , E , and/or F) as shown in the logical-terminal definition table (Figure 3-2). The same keys are effective as in setup level 1. An example of the contents of the operator information area is shown below:

<2> A 1 **B 2** C 4 D 1 E 1 F 2

Where:

<2>

Indicates that the 3290 is in setup level 2.

The labels A , B , C , D , E , and F identify the logical-terminal sets, as shown in the logical-terminal definition table (Figure 3-2). Whether a logical-terminal set is allowable depends on the number of logical terminals defined for it and the number of logical addresses for which the 3290's port is customized. (See Figure 3-6.) Each label is followed by a box containing the number of logical terminals defined for that logical-terminal set. The symbol for the current logical-terminal set is displayed in reverse video (**B 2** , in the above example). Unallowed logical-terminal sets appear as a blank.

— (Cursor)

If the cursor is moved under the symbol for any other logical-terminal set and the Cursor Select key is pressed, this new logical-terminal set becomes the current logical-terminal set and its symbol is displayed in reverse video. When a new logical-terminal set is selected, the 3290 is taken offline and appears to the host program to have been switched off. If the Setup key is pressed, the 3290 exits setup mode and appears to the host to have been switched on again. When the Ready indicator appears in the operator information area, the new logical-terminal set becomes effective and the 3290 is initialized with the characteristics defined in the newly selected set.

◇

The diamond, displayed at the right of the setup level 2 display, allows the operator to select setup level 3 by moving the cursor under the diamond and pressing the Cursor Select key.

To exit setup level 2, either (1) select setup level 3 or (2) press Setup while holding down either Alt key.

When the selection of setup level 3 is attempted, the ✕ indicator appears, indicating that a downstream load request is in progress. A successful downstream load results in the display of the setup level 3 indicator. If the downstream load is not successful, the 3290 remains in setup level 2.

Setup Level 3

When the 3290 enters setup level 3, any modifications made under setup level 2 are canceled and a display similar to that shown in Figure 3-7 preempts the entire display surface. The cursor becomes a blinking-underscore cursor above the separator line, and a non-blinking-underscore cursor in the operator information area. Entering setup level 3 causes the 3290 to be taken offline, and the 3290 appears to the host to have been powered off.

Using setup level 3, the operator can view and change the following:

- The default logical-terminal set for a particular set of 3274 ports
- The default characteristics of a particular logical-terminal set.

When the 3290 enters setup level 3, information associated with logical-terminal set A appears, but the operator may select a different logical-terminal set for display.

While the 3290 is in setup level 3 and the cursor is in the operator information area, the same keys are effective as in setup levels 1 and 2, plus the Jump Partition () key. While the cursor is above the separator line, only the following keys are effective: Numeric, Alpha, Cursor Movement, New Line, Tab, Backtab, Home, Jump Partition, Shift Alt, Setup, Reset, Cursor Select, and Backspace. The Cursor Blink key is effective regardless of the position of the cursor, but the cursor will only blink above the separator line.

Initially, the cursor is located in the table in the lower-left portion of the display space. The cursor can be moved freely within this table or, by pressing the Jump Partition key, can be moved to the next clockwise table. When the cursor is in the lower-right portion of the display space (1 2 3 ?) and the Jump Partition key is pressed, the cursor moves to the operator information area. The cursor can now be moved under the various symbols displayed in the operator information area.

The information in the display space is as follows:

A

Represents how the display space is divided and how each screen is used for the displayed logical-terminal set. The (4) indicates the number of logical-terminal addresses that were customized for the 3274 port to which the 3290 is attached.

B

Is that part of the logical-terminal definition table (Figure 3-2) that pertains to the displayed logical-terminal set. The values in columns 1 through 8 can be changed by the operator to any values that conform to the criteria specified under "Logical-Termination Definition Table."

C

Indicates the possible number of logical-terminal addresses for which a 3274 port can be customized, and the corresponding default logical-terminal-set labels. The default logical-terminal set applies to all 3290s on a 3274 port customized for the specified number of logical-terminal addresses. The

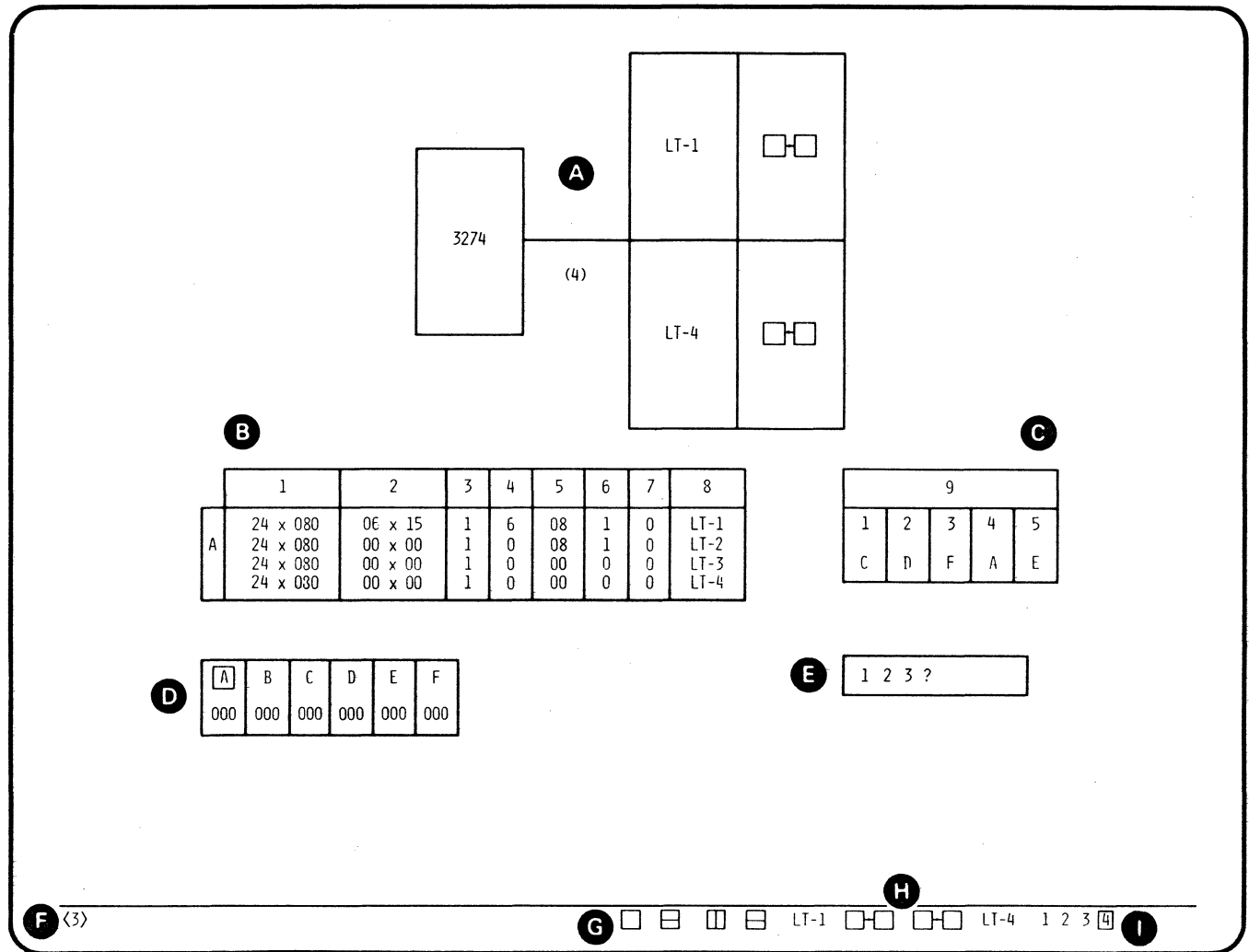

Figure 3-7. Setup Level 3 Display

operator can change the logical-terminal-set label to any value, A through F, specified in the logical-terminal definition table (Figure 3-2), provided the restrictions shown in Figure 3-5 are observed. The operator can also change any of these logical-terminal-set labels to blank. When this is done, any time a 3290 attached to a port having the specified number of logical-terminal addresses is initialized, it goes into setup level 2, and a logical-terminal set must be selected before the initialization of the 3290 can be completed. The 3290 is initialized (1) after power is applied, (2) after exiting setup level 3, or (3) after exiting setup mode following selection of a new logical-terminal set in setup level 2.

To determine the default logical-terminal set for your 3290, use the number in parentheses in **A**. Find this number in **C**. The default set appears below the number. In Figure 3-7, for example, the default set for this terminal is A.

D

Indicates the six logical-terminal-set labels. The label of the logical-terminal set currently displayed is displayed in reverse video. The information in the operator information area, the picture at the top of the display space, and the displayed section of the logical-terminal definition table reflect this logical-terminal set. The three positions (000) under each logical-terminal-set label contain an error code when a validation scan detects an error. The error code displayed indicates the nature of the problem. See Appendix C for error code definitions. To select a different logical-terminal set for display, position the cursor under the label of the desired logical-terminal set and press the Cursor Select key. The information in the display space and in the operator information area is updated to reflect the new logical-terminal set.

E

Provides a means of initiating a validation scan of the values for the displayed logical-terminal set and of attempting to enter these values into the logical-terminal definition table.

When the cursor is moved under the 1 and the Cursor Select key is pressed, a validation scan of the displayed data is initiated.

When a validation scan is initiated, it proceeds in a prescribed sequence either until it is successfully completed or until it detects an error that will terminate the scan. An error code (see Appendix C) is displayed for the error that terminated the scan, and any erroneous characters or fields detected to that point are displayed in reverse video. When the indicated errors have been corrected, a validation scan should be reinitiated. When all errors have been corrected, the validation scan proceeds to completion and no errors are indicated.

When the cursor is moved under the 2 and the Cursor Select key is pressed, a temporary entry of the displayed data is initiated. The entry is preceded by a validation scan, and the actual entry of the displayed data is contingent upon a successful scan. If the entry is successful, the displayed data is stored in the 3290. Subsequent operations by this 3290 are governed by the newly stored data until the 3290 is switched off, or until the 3274 is reloaded.

When the cursor is moved under the 3 and the Cursor Select key is pressed, a permanent entry of the displayed level 3 data is initiated, provided the operator has entered the correct password at the location identified by ? . If no password or an incorrect password was entered, the data is accepted as a temporary entry instead of as a permanent entry, and an error code indicating an invalid password is displayed. The ? is displayed in reverse video.

The entry is preceded by a validation scan of the displayed data, and the actual entry of the data is contingent upon a successful scan. If the entry is successful, the data is stored on the 3290 load diskette in the 3274 (replacing the previous data). When Setup mode is exited, the 3290 is configured according to the newly stored data. All other attached 3290s are configured according to the newly stored data the next time they are powered on, or when the 3274 is reloaded.

The ? is followed by a blank, and then by six blank positions, into which the password must be entered each time a permanent entry of the values is made. This field is not displayed.

Note: The password is defined during customization.

Taken from left to right, the operator information area symbols are as follows:

F

Indicates that the 3290 is in setup level 3.

G

Indicates the allowable screen divisions for the displayed logical-terminal set. The default screen division symbol for this logical-terminal set is displayed in reverse video. To change the default screen division for this logical-terminal set, move the cursor under the symbol for the desired screen division, and press Cursor Select. The new symbol is displayed in reverse video, and the picture at the top of the display space changes to show the new screen division.





H

Indicates the use of each screen area (by a screen designator) for this logical-terminal set, starting at the top-left screen and proceeding clockwise. (Refer to "Setup Level 1.") Before these changes can take effect, the following conditions must exist:

- At least one logical screen must be displayed.
- The same logical screen cannot be displayed in more than one screen area.



Both the default and the alternate screen dimensions for each logical terminal in this set must be containable within the usable area indicated by the number displayed in reverse video. The numbers represent the following usable areas:

1.  Full screen
2.  Horizontal half
3.  Vertical half
4.  Quadrant

To select another usable area for this logical-terminal set, move the cursor under the corresponding number and press Cursor Select. The new number is displayed in reverse video. The operator information area may display new allowable screen divisions and screen designators, and the display space is updated.

To exit setup level 3, press Setup while holding down either Alt key. The cursor returns to the form it had before setup level 3 was entered.

Logical-Terminal Screen Sizes and Character Cell Sizes

The manner in which the default and alternate screen sizes associated with a logical terminal are specified depends upon whether the 3290 operates in a SNA or non-SNA environment. The acceptance or rejection of a screen size specification depends on the defined cell size and on the size of the screen area for that logical terminal.

In both SNA and non-SNA environments, character cell size can be either nondefined (variable) or defined (fixed). Minimum and maximum cell sizes are specified in the discussion of the logical-terminal definition table and in Figure 3-8. The *Fixed* column shows the maximum character cell size allowed in the logical terminal definition table when the specified usable areas are used. The *Variable* column shows the cell size the 3290 uses if the character cell size is undefined in the logical terminal definition table for the given usable area.

Usable Area	3278 Model Number							
	Model 2 24 x 80		Model 3 32 x 80		Model 4 43 x 80		Model 5 27 x 132	
	Fixed	Var	Fixed	Var	Fixed	Var	Fixed	Var
Full	12x31	9x24	12x31	9x24	12x17	9x17	7x27	7x20
Horizontal	12x15	9x15	12x15	9x15	12x15	9x15	7x13	7x13
Vertical	6x31	6x20	6x23	6x20	6x17	6x17	6x17	6x17
Quarter	6x15	6x15	6x15	6x15	6x15	6x15	6x15	6x15

Figure 3-8. Character Cell Sizes

Logical-Terminal Screen Size (Non-SNA)

For proper presentation on the screen in the non-SNA environment, the 3290 default and alternate screen sizes must correspond with those assumed by the host program. The alternate screen size is defined in the logical-terminal definition table. The logical-terminal default screen size is 24x80.

Logical-Terminal Screen Size (SNA)

In the SNA environment, bytes 20 through 24 in the LU Type 2 Bind command specify, for the duration of an LU-LU session, the number of rows and columns (RxC) for the default and alternate screen sizes used by the EW and EWA commands, respectively. Figure 3-9 lists the six specification options associated with byte 24 and the associated default and alternate screen sizes, assuming a variable cell size.

Byte in Bind Command					Default Screen size (RxC) (EW Command)	Alternate Screen size (RxC) (EWA Command)
20	21	22	23	24		
—	—	—	—	00	24x80	24x80
—	—	—	—	01	12x40	12x80
—	—	—	—	02	24x80	24x80
—	—	—	—	03	24x80	As defined in logical-terminal definition table
Rd	Cd	—	—	7E	RdxCd	RdxCd
Rd	Cd	Ra	Ca	7F	RdxCd	RaxCa

Ra = ≤ 1 Ra ≤ 62 = Rows in alternate screen (EWA command)
 Rd = ≤ 1 Rd ≤ 62 = Rows in default screen (EW command)
 Ca = ≤ 1 Ca ≤ 160 = Columns in alternate screen (EWA command)
 Cd = ≤ 1 Cd ≤ 160 = Columns in default screen (EW command)

Note: SSCP-LU sessions always use the 24x80 screen size.

Figure 3-9. Specification Options for Byte 24 of the Bind Command

Partition/Viewport Size

In explicit partitioned state, the sizes (row and column) of the partitions (presentation spaces and their associated viewports) are determined by the specified parameters (or their defaults) in the Create Partition command. Because the 3290 supports only vertical scrolling, the width of the viewport must always coincide with the width of the presentation space for the partition.

Character Cell Sizes

Character cell sizes can be specified in the logical-terminal definition table and in the Create Partition command. Allowable cell widths are from 06 through 12 (decimal) inclusive. Allowable cell heights are from 12 through 31 (decimal) inclusive. Specifications outside these limits are rejected.

In implicit partition state, the cell size specified in the logical-terminal definition table determines the dimensions of the logical screen in the usable area for that logical-terminal set. If no cell size is specified, the cell size is variable and the 3290 uses the cell size that is most advantageous for the specified logical screen in

the usable area for that logical terminal. When use of the smallest allowable cell size does not allow the specified logical screen to be contained within the usable area for that logical terminal, the specification is rejected.

In explicit partitioned state, the cell size specified in the Create Partition command is used in that partition. If no cell size is specified in the Create Partition command, the cell size specified in the logical-terminal definition table for that logical terminal is used as the default cell size. If neither is specified, a default cell size of 6x12 is used.

Zoom Function

The *zoom* function enhances the readability of selected alphanumeric information that is displayed in a densely packed small character size.

Pressing the Zoom key causes the 3290 to enter or exit zoom mode. When the 3290 enters zoom mode, only the active (explicit or implicit) partition (or its viewport) within the active logical screen is displayed, with the largest allowable character size and optimum spacing. The remainder of the screen is erased. If the displayed information is already displayed in the largest allowable character size and optimum spacing, the 3290 enters zoom mode, but there is no discernible difference in the displayed information.

Pressing the Jump Partition () , Jump Screen (JmpSc), or Change Screen (ChgSc) key causes the screen to be erased and the new active screen or partition to be displayed, with the largest allowable character size and optimum spacing. Any screen that was a foreground screen before zoom mode was entered is still treated as a foreground screen in zoom mode, even though it is not displayed. It can still interact with the host and be made active by pressing the Jump Screen key.

When the 3290 exits zoom mode, all logical screens are restored to their original size and spacing, but copy screens are not restored.

Rule Function

The *rule* function allows the operator to cause the display of a single horizontal rule line under one row of characters within a logical screen or partition (or its viewport). The rule line is displayed across the full width of the logical screen or partition (or its viewport) and can help the operator relate widely separated data in the same row.

The rule line is positioned in the bottom PEL row of the character cells and is a broken line to distinguish it from an underscore or from an emphasis line. The rule line is invoked under the character row containing the cursor when the Rule key is pressed. If the Rule key is pressed again, the rule line is erased.

Once displayed, the rule line either remains in the row in which it was originally invoked or follows the cursor when the cursor moves to a new row, depending upon the option selected (RN or RC) in setup level 1. When the 3290 is switched on, the rule line does not follow the cursor.

The rule line is not transmitted. When the 3290 is switched on or after start-of-session (SNA), the rule line is off. Whenever a logical screen is erased, its rule line is also erased.

Rule Function in Implicit Partition State

When a logical terminal is in implicit partition state, a maximum of one rule line across the full width of its logical screen is permitted.

If the active logical screen does not display a rule line and the Rule key is pressed, a rule line is displayed beneath the character row containing the cursor.

If the active logical screen displays a rule line and the Rule key is pressed, the rule line is erased. The rule line is also erased whenever this same logical screen is erased or destroyed. An active logical screen can be erased or destroyed by the Clear, SYS REQ (SNA only), or Test key; by a bind operation; by an EW, EWA, or ERASE/RESET command; or by the transition from implicit partition state to explicit partitioned state resulting from a Create Partition command.

Rule Function in Explicit Partitioned State

When a logical terminal is in explicit partitioned state, a maximum of one rule line across the full width of each partition in its logical screen is permitted. The rule line is associated with its character row and, if scrolling is allowed in this partition, the rule line can be scrolled up or down along with its character row. The rule line and its associated character row can be scrolled beyond the viewport, and both disappear and reappear together.

If the Rule key is pressed while no rule line is displayed within the viewport of the active partition, a rule line is displayed under the character row containing the cursor and any rule line outside the viewport is canceled.

If the Rule key is pressed while a rule line is displayed within the viewport of the active partition, the rule line is erased. The Clear Partition (☐) key clears the active partition and any rule line, whether inside or outside the viewport. The Create Partition, Destroy Partition, Erase/Reset, EW, or EWA command directed to any partition erases any rule line in that partition as well as the partition itself. Any action that causes the active logical terminal to revert to implicit partition state also destroys the partition and any rule line it may contain.

Image Limit

There is a limit on the number of PELs that can be lit on the panel at any one time. Reaching this limit causes the *image limit* condition to occur, and the panel to be rewritten as follows:

- The entire display space is erased.
- The operator information area and the row containing the cursor are written in full.
- The copy screen is not written.
- All other areas are written with the bottom row of PELs on each line omitted.
- The Image Limit (■→■) indicator appears in the operator information area, except in setup mode or copy screen mode.

If, after the rewrite operation occurs, the image limit condition still exists, the rewrite operation is repeated, but the bottom two rows of PELs on each line are omitted. The rewriting continues (with each rewrite omitting an additional row of PELs from each line) until the image limit condition no longer exists.

If the Insert Mode (^) indicator is displayed, pressing Reset erases the indicator. Pressing Reset again removes the Image Limit indicator and causes the panel to be rewritten with no row of PELs omitted. Copy screens, however, are not rewritten. If this rewriting of the panel causes the image limit condition to occur again, the process of rewriting the panel as described above is repeated.

Row/Column Indicator

The Row/Column indicator helps the operator position the cursor accurately. Near the right side of the operator information area, the current cursor position within the active logical screen or within the active partition is always displayed (except in setup or copy screen mode), as shown below:

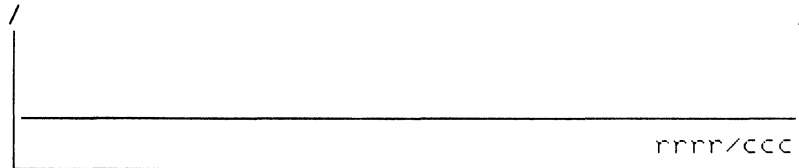

rrrr = cursor row location in decimal with preceding 0s
ccc = cursor column location in decimal with preceding 0s

Logical-Terminal Identifier

The logical-terminal identifier shows the identifier of the logical terminal displayed in the active logical screen. It appears to the left of the Row/Column indicator in the operator information area. It can contain up to four characters or be blank. The operator can assign identifiers to logical terminals using setup level 3. The IBM-supplied logical-terminal identifiers are shown in Figure 3-2.

3290-Unique Aspects of the Local Copy Function

The 3290 supports the *local copy* function, using the 3274 printer authorization matrix, when the selected printer has SNA character string (SCS) capability. If the selected printer does not have SCS capability, the Operator Unauthorized indicator (✕ † ✕) is displayed in the operator information area and the copy function is not performed.

The 3274 printer authorization matrix and the SCS are explained in the *IBM 3270 Information Display System 3274 Control Unit Description and Programmer's Guide*, GA23-0061. Certain SCS functions for local copy must be redefined. Only the 3290-unique information is provided here.

The 3290 constructs the SCS data stream, using the following control codes:

Control Code	Mnemonic	EBCDIC (Hex) Code
Set Horizontal Format	SHF	2BC1
New Line	NL	15
Carriage Return	CR	0D
Form Feed	FF	0C
Graphic Escape	GE	08
Set Attribute	SA	28

SHF: The 3290 sends SHF (X'2BC10200'), indicating that the printer will set all horizontal formatting values to their default values.

NL: The 3290 sends NL to indicate the end of each buffer row. An NL in the buffer is replaced by X'40' in the SCS and is printed as a space.

CR: The 3290 always sends a CR at the start of any local copy operation, causing the carrier to return to the left margin.

FF: An FF in the 3290 is replaced by X'40' in the SCS and is printed as a space. If the FF is in column 1 of any row, the FF is sent to the printer, which moves the form to the top line of the next form and then prints a space to maintain the format.

GE: If the printer does not support graphic escape, the 3290 does not send GE to the print buffer and the following code point is printed in the base character set. If the printer does support graphic escape, the 3290 sends GE and the following code point is printed in character set 1. In either case, the format is maintained (no space is printed for the GE character).

SA: If the printer does not support SA, the 3290 does not send SA and the format is maintained. If the printer does support SA, the 3290 sends SA. Any character sets present in the 3290 but not in the printer (or not allowed to be copied by the printer) default to type PS and value X'00'. All highlight and color attribute types and values are sent to a printer that supports SA.

Row Suppression

If a row contains all unprintable characters (nulls, field attributes, nondisplay, and/or nonprint characters), the row is not printed and the form does not advance. If the row contains one or more printable characters (including a space), the line prints and the form advances.

Local Copy Initiation

The local copy function can be initiated by the operator or by the host program (SNA only).

Operator-Initiated Local Copy

The operator initiates a local copy of data from the active logical screen by pressing the Print key and selecting the print symbol ($\square \rightarrow \square$) in the operator information area. The data that is copied depends upon the 3290 state active at the time, as shown in Figure 3-10.

State	From Logical-Terminal Definition Table		Data Copied
	Scrolling Enabled	Copy Viewport	
Implicit Partition	NA	NA	Implicit partition 0 for the active logical term
Explicit Partitioned	No	NA	Active partition for the active logical term
	Yes	No	Presentation space for the active partition for the active logical terminal
	Yes	Yes	Viewport for active partition for the active logical term

Figure 3-10. Data Copied for Operator-Initiated Local Copy

Host-Initiated Local Copy

The host program (SNA only) initiates a local copy of any data from any logical terminal that is logged on by issuing a Write command (or an outbound 3270DS structured field containing a Write command) with the WCC start-print bit set to 1. The data that is copied depends on the 3290 state, on the functions active at the time, and on whether the Write command is enclosed in an outbound 3270DS structured field, as shown in Figure 3-11.

Host Contention with Operator-Initiated Local Copy

The results of host contention with an operator-initiated local copy function depends upon whether the 3290 is operating under SNA or non-SNA protocols.

SNA. If an outbound FM data request is received during the queuing of an operator-initiated local copy request or during the data transfer to the printer, the FM data request is rejected with a BUSY indication (X'082D'). When the data transfer is completed, an LUSTAT of X'0001D000' is sent to the host to indicate that the busy condition no longer exists. An outbound FM data request can then be honored.

State	Write Command in Structured Field	From Create Partition Structured Field (Byte 5)		Data Copied
		Scrolling Enabled	Copy Viewport	
Implicit Partition	NA	NA	NA	Implicit partition 0 for the logical terminal to which the Write command is addressed
Explicit Partitioned	No	No	NA	Partition 0 for the logical terminal to which the Write command is addressed
	Yes	No	NA	Partition specified in the outbound 3270DS structured field for the logical terminal to which the Write command is addressed
	No	Yes	No	Presentation space for partition 0 for the logical terminal to which the Write command is addressed
	Yes	Yes	No	Presentation space for the partition specified in the outbound 3270DS structured field for the logical terminal to which the Write command is addressed
	No	Yes	Yes	Viewport for partition 0 for the logical terminal to which the Write command is addressed
	Yes	Yes	Yes	Viewport for the partition specified in the outbound 3270DS structured field for the logical terminal to which the Write command is addressed

Figure 3-11. Data Copied for Host-Initiated Local Copy

Non-SNA. If an outbound transmission arrives after an operator-initiated local copy request is queued, the result depends upon whether the local copy data transfer to the printer has started.

If the local copy data transfer has not started, the host transmission is accepted and the local copy request is retained until the end of the outbound transmission. The end of the outbound transmission occurs when ETX or EOT (BSC) is sent and a command, or series of commands, is completed, or when an error occurs during channel operation. The operator-initiated copy will be of updated data. Once the outbound transmission starts, the operator cannot initiate a local copy request until the outbound transmission ends.

If the local copy data transfer has started but has not ended, the outbound transmission is rejected.

Printer PA Key Operation during Local Copy

If a printer PA key is pressed during a 3290 local copy operation, the 3274 delays the request until the copy is completed. After completion of the local copy, if there is an active SNA LU 1 session, the PA request is sent to the host. If there is no active SNA LU 1 session, the PA request is discarded by the 3274.

Customizing for the Local Copy Function

To make the 3290 Local Copy function adaptable to your environment, a set of customization options has been provided. You can select the appropriate combination of these options to customize your 3290 to generate an automatic form feed (before and/or after a local copy operation) and for 3290 local copy format controls.

See the *IBM 3270 Information Display System 3274 Control Unit Planning, Setup, and Customizing Guide*, GA27-2827 (Configuration Support T), or the *IBM 3270 Information Display System 3274 Control Unit Customizing Guide*, GA23-0065 (Configuration Support D).

Chapter 4. 3270 Data-Stream Functions

This chapter describes the 3270 data-stream functions supported by the 3290. For general information on *all* the 3270 data-stream functions, refer to the *IBM 3270 Information Display System Data Stream Programmer's Reference*, GA23-0059.

In this chapter, those functions of the 3270 data stream that are supported by the 3290 are listed and any 3290-unique information is provided. For those familiar with the 3270 data stream, the information in this chapter should be sufficient for most purposes.

Interface Codes

Data commands and orders transmitted between the 3290 and the host system are in the form of extended binary-coded decimal interchange code (EBCDIC) interface codes. Refer to *IBM 3270 Information Display System: Character Set Reference*, GA27-2837, for details.

Figure 4-1 shows the United States EBCDIC interface codes; Figure 4-2, the control character codes.

Hex 1	00				01				10				11				Bits
	00	01	10	11	00	01	10	11	00	01	10	11	00	01	10	11	0,1
	0	1	2	3	4	5	6	7	8	9	A	B	C	D	E	F	Hex 0
0000	0	NUL			SP	&	.						{	}	\	0	
0001	1		SBA			/		a	j	~			A	J		1	
0010	2		EUA					b	k	s			B	K	S	2	
0011	3		IC					c	l	t			C	L	T	3	
0100	4							d	m	u			D	M	U	4	
0101	5	PT	NL					e	n	v			E	N	V	5	
0110	6							f	o	w			F	O	W	6	
0111	7							g	p	x			G	P	X	7	
1000	8	GE		SA				h	q	y			H	Q	Y	8	
1001	9		EM	SFE				'	i	r	z			I	R	Z	9
1010	A				¢	!		:									
1011	B				.	\$.	#									
1100	C	FF	DUP	MF	RA	<	*	%	@								
1101	D	CR	SF		()	_	'									
1110	E		FM		+	:	>	=									
1111	F			SUB		^	?	"								EO	

Notes:

- Codes X'00' through X'1F' and X'FF' are control codes, and codes X'40' through X'FE' are character codes. All blank squares in this chart represent undefined codes. All defined character codes are enclosed by heavy lines. Undefined control codes are rejected with a negative response (SNA) or an Op Chk (non-SNA). If the extended attribute buffer (EAB) is enabled, all undefined character codes are accepted, stored, and returned without change on a subsequent read operation. If the EAB is disabled, character codes X'CE', X'CF', X'DD', X'DE', X'DF', X'ED', X'EE', X'EF', and X'FE' are stored, displayed, and returned as the hyphen character (X'60') and all other undefined character codes are accepted, stored, and returned without change. IBM reserves the right to change at any time the character displayed or printed and the I/O interface code returned for an undefined character code.
- CR, NL, EM, and FF control characters are displayed and printed as spaces. If extended attributes are not enabled, the DUP and FM control characters are respectively displayed as * and ; in dual-case mode and as * and ; in monospace mode. If extended attributes are enabled, DUP and FM are always displayed as * and ; respectively. DUP and FM are always printed as * and ; respectively.
- Bits 0 and 1 are assigned for the following characters: AID, attribute, write control (WCC), device address, buffer address, sense, and status. Bits 0 and 1 are assigned so that each character can be represented by a graphic character within the solid outlined areas of the chart. See Figure 4-2.
- During monospace mode, the lowercase alphabetic characters are displayed or printed as uppercase characters.

Figure 4-1. United States EBCDIC I/O Interface Code

Bits 2—7	Graphic	EBCDIC (Hex)	Bits 2—7	Graphic	EBCDIC (Hex)
00 0000	SP	40	10 0000	.	60
00 0001	A	C1	10 0001	/	61
00 0010	B	C2	10 0010	S	E2
00 0011	C	C3	10 0011	T	E3
00 0100	D	C4	10 0100	U	E4
00 0101	E	C5	10 0101	V	E5
00 0110	F	C6	10 0110	W	E6
00 0111	G	C7	10 0111	X	E7
00 1000	H	C8	10 1000	Y	E8
00 1001	I	C9	10 1001	Z	E9
00 1010	⌈	4A	10 1010		6A
00 1011		4B	10 1011	,	6B
00 1100	<	4C	10 1100	⌋	6C
00 1101	(4D	10 1101		6D
00 1110	+	4E	10 1110	≥	6E
00 1111		4F	10 1111	?	6F
01 0000	&	50	11 0000	0	F0
01 0001	J	D1	11 0001	1	F1
01 0010	K	D2	11 0010	2	F2
01 0011	L	D3	11 0011	3	F3
01 0100	M	D4	11 0100	4	F4
01 0101	N	D5	11 0101	5	F5
01 0110	O	D6	11 0110	6	F6
01 0111	P	D7	11 0111	7	F7
01 1000	Q	D8	11 1000	8	F8
01 1001	R	D9	11 1001	9	F9
01 1010		5A	11 1010	:	7A
01 1011	L	5B	11 1011	#	7B
01 1100	*	5C	11 1100	⌑	7C
01 1101)	5D	11 1101	'	7D
01 1110	;	5E	11 1110	=	7E
01 1111	⌋	5F	11 1111	"	7F

Notes:

1. The characters above are used as attribute, AID, write control (WCC), CU and device address, and buffer address.
2. To use this table to determine the hex code transmitted for an address or control character, first determine the values of bits 2—7. Select this bit configuration from the the *Bits 2 — 7* column. The hex code that will be transmitted is to the right of the bit configuration.
3. Use this table also to determine equivalent EBCDIC hex codes and their associated graphic characters. Graphic characters for the United States I/O interface codes are shown. Graphic characters might differ for particular World Trade I/O interface codes. For possible graphic differences when these codes are used, refer to *IBM 3270 Information Display System: Character Set Reference, GA27-2837*.

Figure 4-2. EBCDIC Control Character I/O Codes

Attributes

The 3290 display station supports field attributes, extended field attributes, and character attributes.

Field Attributes

Figure 4-3 shows the field attribute byte and the bit assignments for the field attributes supported by the 3290.

X	1	U/P	A/N	D/SPD	0	MDT	Field Attribute Byte	
0	1	2	3	4	5	6	7	Bit Positions
EBCDIC Bit	Field Description							
0	Value determined by contents of bits 2—7. See Figure 4-2 for hexadecimal values.							
1	Always 1							
2	0 = Unprotected 1 = Protected (see Note 1)							
3	0 = Alphanumeric 1 = Numeric (If numeric lock capability is activated, causes automatic numeric shift of keyboard) (see Note 1)							
4,5	00 = Display not detectable by Cursor Select key 01 = Display detectable by Cursor Select key 10 = Intensified display detectable by Cursor Select key (see Note 2) 11 = Nondisplay, nonprint, nondetectable							
6	Reserved — Always 0.							
7	Modified data tag (MDT); identifies modified fields during Read Modified command operation 0 = Field has not been modified. 1 = Field has been modified by the operator. Can also be set by program in data stream							

Notes:

- Bits 2 and 3 equal to 11 causes an automatic skip.
- Intensified display is simulated by displaying a solid line (an entire dot-row) beneath all character positions in the field, except those positions containing null and space characters and the first character position (containing the field attribute character).

Figure 4-3. Field Attribute Character Bit Assignment

Extended Field Attributes and Character Attributes

The following attribute types and attribute values are supported by the 3290 as extended field attributes (EFAs) and as character attributes (CAs). All other attribute types and attribute values are rejected with a negative response (SNA) or an Op Check (non-SNA).

Attribute Type X'41' – Extended Highlighting

Attribute Value (Hex)	EFA	CA
00	Default	Default (to EFA)
F1	Blink	Blink
F2	Reverse video	Reverse video
F4	Underscore	Underscore

Attribute Type X'42' – Color

Although incapable of displaying in any color except orange, the 3290 accepts the color attribute type (X'42') with attribute values X'00' and X'F1' through X'F7' and returns them unchanged on a subsequent Read command. In response to a query structured field, the 3290 returns X'FA' (orange), but, if X'FA' is encountered in an outbound data stream, it is rejected.

Attribute Type X'43' – Character Set Selection

Attribute Value (Hex)	EFA	CA	LCID Default
00	Default	Default (to EFA)	
F1	Reserved	APL-Text	
F2	PSA	PSA	FF
F3	PSB	PSB	FF
F4	PSC	PSC	FF
F5	PSD	PSD	FF
F6	PSE	PSE	FF
F7	PSF	PSF	FF

Commands

For a description of the functions of the following commands, see the *IBM 3270 Information Display System 3274 Control Unit Description and Programmer's Guide*, GA23-0061.

3270 Data Stream Commands

The following 3270 data stream commands, unless used within the structured-field format, apply only to implicit or explicit partition 0.

Command	Mnemonic	Command Code—EBCDIC (Hex)		Graphic
		SNA/BSC	Non-SNA Channel	
Write	WRITE	F1	01	1
Erase/Write	EW	F5	05	5
Erase/Write Alternate	EWA	7E	0D	=
Write Structured Field	WSF	F3	11	NA
Erase All Unprotected	EAU	6F	0F	?
Read Buffer	RB	F2	02	2
Read Modified	RM	F6	06	6
Read Modified All	RMA	6E	NA	>

Non-SNA Channel Commands

Although not part of the 3270 data stream, the following channel commands are valid for non-SNA channel-attached 3290 display stations.

Command	Mnemonic	Non-SNA Channel Command Code—EBCDIC (Hex)
No Operation		03
Sense		04
Select Read Modified	Select RM	0B
Select Read Buffer	Select RB	1B
Select Read Modified from Position	Select RMP	2B
Select Read Buffer from Position	Select RBP	3B
Select Write	Select WRT	4B

Write Control Character

The write control character (WCC) bits have the following significance for the 3290:

WCC Bit	Explanation
0	No function
1	No function for the WRT command. Reset function, if set to 1, for EW and EWA commands. See Figure 4-4 for the effects of the reset function when the 3290 is in implicit partition state and in explicit partitioned state.
2, 3	Reserved
4	Start printer (SNA only). When set to 1, initiates a local-copy operation at the completion of the write operation. If no printer is available, a negative response X'0801', X'082E', or X'082F' is returned.
5	Sound alarm. When set to 1, causes the audible alarm to sound.
6	Keyboard restore. When set to 1, causes keyboard operation to be restored (by resetting system lock or WAIT indicator) and resets AID byte to X'60'.
7	Reset MDT bits in field attributes (WRT command only). When set to 1, causes MDT bits to be reset to 0 in all field attribute bytes in the specified partition, before any orders or data characters are processed.

3270 Data Stream Orders

The 3290 supports the following 3270 data stream orders.

Order	Mnemonic	Order Code EBCDIC (Hex)
Start Field	SF	1D
Start Field Extended ¹	SFE	29
Set Buffer Address	SBA	11
Set Attribute ¹	SA	28
Modify Field ¹	MF	2C
Insert Cursor	IC	13
Program Tab	PT	05
Repeat to Address	RA	3C
Erase Unprotected to Address	EUA	12
Graphic Escape	GE	08

¹ The SFE, SA, and MF orders are valid only when the extended attribute buffer (EAB) is enabled for the logical terminal to which the order is directed. When the EAB is not enabled, these orders are rejected with a negative response (SNA) or an Op Chk (non-SNA).

Reset Condition	Implicit Partition State	Explicit Partitioned State
<p>1. WCC following Erase/Write or an Erase/Write Alternate command.</p> <p>a. WCC = Reset.</p> <p>b. WCC = No reset.</p>	<p>Execute the command; reset the inbound reply mode to field.</p> <p>Execute the command.</p>	<p>Reset inbound reply mode to field. Reset the display to the implicit partition state; execute the command.</p> <p>Execute the command against explicit partition 0; if no explicit partition 0, reject the command with negative RSP.</p>
<p>2. WCC following a Write command.</p> <p>a. WCC = Reset or no reset.</p>	<p>Execute the command.</p>	<p>Execute the command against explicit partition 0; if no explicit partition 0, reject the command with negative RSP.</p>
<p>3. WCC in outbound 3270DS header, and the function is Erase/Write or Erase/Write Alternate.</p> <p>a. WCC = Reset.</p> <p>b. WCC = No reset.</p>	<p>If the PID equals 0, execute the function (except for screen-size changes) and reset the inbound reply mode to field. If the PID does not equal 0, reject with negative RSP.</p> <p>If the PID equals 0, execute the function. If the PID does not equal 0, reject with RSP.</p>	<p>Reset the designated (PID) partition, and execute the function against the designated partition. If the designated partition does not exist, reject with negative RSP.</p> <p>Execute the function against the designated (PID) partition. If the designated partition does not exist, reject with negative RSP.</p>

Figure 4-4 (Part 1 of 2). Write Control Character (WCC) Reset Actions

Reset Condition	Implicit Partition State	Explicit Partitioned State
4. WCC in outbound 3270DS header, and the function is Write. a. WCC = Reset or no reset.	Execute the function if the PID equals 0; otherwise, reject with negative RSP.	Execute the function against the designated (PID) partition. If the designated partition does not exist, reject with negative RSP.

Figure 4-4 (Part 2 of 2). Write Control Character (WCC) Reset Actions

Outbound 3270 Data Stream Structured Fields

The Write Structured Field (WSF) command (X'F3') is used by the host program to transmit the following outbound structured fields to the addressed logical terminal in the in-selection logical-terminal set.

Outbound Structured Field	ID Code (EBCDIC-Hex)
Load Programmed Symbols	06
Create Partition	0C
Activate Partition	0E
Destroy Partition	0D
Set Window Origin	0B
Set Reply Mode	09
Reset Partition	00
ERASE/RESET	03
Outbound 3270DS	40
Write	F1
Erase/Write	F5
Erase/Write Alternate	7E
Erase All Unprotected	6F
Read Partition	01
Read Buffer	F2
Read Modified	F6
Read Modified All (SNA only)	6E
Query	02

All other structured-field ID codes are rejected with a negative response (SNA) or an Op Chk (non-SNA).

Load Programmed Symbols Structured Field Format

The *load programmed symbols* structured field can be used whether the 3290 is in implicit partition or explicit partitioned state.

Byte	Bit	Content	Meaning
0, 1		X'0000' or L	Length of structured field in bytes
2		X'06'	Load programmed symbols (load PS) ID code
3	0	Flags 0 1	Basic or extended form: Basic form — Only bytes 0—6 present Extended form—Length determined by byte 7
	1	Clear 0 1	Clear PS Read/Write Storage (RWS) prior to loading. Do not clear PS RWS Clear specified PS RWS
	2	—	Ignored
	3—7	Type 00000 00001 00010 others	PS data format type: Reserved Type 1 — 18-byte form: the first 2 bytes contain a 16-bit vertical slice; the following 16 bytes contain 8-bit horizontal slices. Type 2 — Compressed form Reserved
4		LCID	Local character set ID: X'40' through X'EF' X'FF' indicates RWS associated with this LCID is free (not assigned) Other values reserved
5		Char.	Beginning code point: X'41' through X'FE'
6		RWS	PS set RWS number X'02' through X'07'
7		Data or P LENGTH	If basic form, character cell definitions. If extended form, length of parameters, including the length parameter. The parameters defined below are progressively included by specifying of the appropriate length. Omitted parameters are assumed to have the defined default parameter indicated by the zero value for that parameter.
8	0	0	Reserved — must be zero
	1	CB 0 1	LCID compare bit: LCID compare (default value) No LCID compare
	2	OB 0 1	Operator—selectable by PS key: Operator—selectable (default value) Not operator—selectable
	3—7	00000	Reserved — must be all zeros
9		X'00' or X'09'	Number of X-units in dot matrix (default X'00')

Byte	Bit	Content	Meaning
10		X'00' or X'10'	Number of Y-units in dot matrix (default X'00')
11		X'00'	Reserved – must be all zeros
12		X'00'	Reserved – must be all zeros
13 to (L-1)		Data	Character cell definitions

Create Partition Structured Field Format

If the 3290 is in implicit partition state, the *create partition* structured field destroys implicit partition 0 and places the 3290 in explicit partitioned state. The first partition created becomes the active partition, unless otherwise specified in a subsequent activate partition structured field.

Byte	Content	Meaning	Default
0, 1	X'0003' through X'001E'	Length of structured field in bytes	
2	X'0C'	Create partition ID code	
3	PID	Partition identifier of partition being created	X'00'
4	UQM/AM X'00' X'01' X'20' X'21'	Viewport offset units/address mode; Viewport offset in character cells/12- or 14-bit address mode Viewport offset in character cells/16-bit address mode Viewport offset in PELs/12- or 14-bit address mode Viewport offset in PELs/16-bit address mode	X'00'
5	X'00' X'20'	Copy viewport only Copy presentation space	X'00'
6, 7 8, 9	D W	Depth of presentation space (in character rows) Width of presentation space (in character columns)	Bytes 8 and 9 Bytes 6 and 7 (of usable area query reply)
10, 11	RV	Offset of top edge of viewport from top of usable screen	X'0000'
12, 13	CV	Offset of left edge of viewport from left of usable screen	X'0000'
14, 15	DV	Depth of viewport (in character rows)	DV

Byte	Content	Meaning	Default
16, 17	WV	Width of viewport must equal W (in character rows)	WV
18, 19	RW	Offset of top of window from top of presentation space (in character rows)	X'0000'
20, 21	X'0000'	Reserved; must be X'0000'	X'0000'
22, 23	RS	Vertical scrolling increment (in character rows)	X'0001'
24, 25	X'0001'		X'0001'
26, 27	PW	Number of horizontal PELs in a character cell in this partition	As defined in logical-terminal definition table (X'06' by X'0C' if not defined)
28, 29	PH	Number of vertical PELs in a character cell in this partition	

Note: If byte 4 does not contain X'00', X'01', X'20', or X'21', or if there is any other invalid condition, the structured field is rejected with a negative response (SNA) or an Op Check (non-SNA).

Activate Partition Structured Field Format

The *activate partition* structured field makes the specified partition, if present, the active partition.

Byte	Content	Meaning
0, 1	X'0004'	Length of structured field in bytes
2	X'0E'	Activate-partition ID code
3	PID	Partition identifier (must be X'00' for implicit partition state) of partition being activated

Note: The activate partition structured field is ignored if the 3290 is in implicit partition state and the specified PID is X'00'. If a partition with the specified PID does not exist, the structured field is rejected with a negative response (in SNA) or an Op Check (in non-SNA).

Destroy Partition Structured Field Format

The *destroy partition* structured field destroys the specified partition. If the destroyed partition was the only partition, the 3290 enters implicit partition state and creates implicit partition 0, of default dimensions.

Byte	Content	Meaning
0, 1	X'0004'	Length of structured field in bytes
2	X'0D'	Destroy-partition ID Code
3	PID	Partition identifier of partition being destroyed

If the destroyed partition was the active partition, the partition with the next sequential PID is activated. If no next sequential PID exists, the first sequential PID is activated. If no partition exists with the specified PID, the structured field is ignored.

Set Window Origin Structured Field Format

The *set window origin* structured field repositions the window within the presentation space to the specified offset (RW). The current cursor position (CCP) is not changed unless it falls outside the new window. If outside the window, the CCP is moved the minimum number of rows to place it within the window.

Byte	Content	Meaning
0, 1	X'0008'	Length of structured field in bytes
2	X'0B'	Set-window-origin ID code
3	PID	Partition identifier
4, 5	RW	Row offset of top of window
6, 7	X'0000'	Must be X'0000'

Notes:

1. If any of the following conditions exists, the structured field is rejected with a negative response (SNA) or an Op Check (non-SNA):
 - a. A partition with the specified PID does not exist.
 - b. The offset (RW) plus the window depth (DV) is greater than the depth (D) of the presentation space.
 - c. Bytes 6 and 7 are not set to X'0000'.
2. If the 3290 is in implicit partition state and the structured field PID is X'00', the structured field is ignored.

Set Reply Mode Structured Field Format

The *set reply mode* structured field specifies the reply mode required in all subsequent inbound data streams from the specified partition. The specified reply mode remains in effect for this partition until it is changed by one of the following, directed to this partition:

- Another set reply mode structured field, specifying a different reply mode
- An ERASE/RESET structured field
- A reset partition structured field
- An EW or EWA command or a structured field with the WCC bit 1 set to 1, causing a reset function.

If the specified partition does not exist, the function is rejected.

Byte	Content	Meaning
0, 1	X'0005' through X'0008'	Length of structured field in bytes
2	X'09'	Set-reply-mode ID code
3	PID	Partition identifier (must be X'00' for implicit partition state) X'00'—X'0F'
4	X'00' X'01' X'02'	Reply mode requested Field mode (default) Extended field mode Character mode
5	X'41'	Highlighting selection (Notes 1, 2, and 3)
6	X'43'	PS set selection (Notes 1, 2, and 3)
7	X'42'	Color selection (Notes 1, 2, and 3)

Notes:

1. More than five bytes can be present only when character mode (X'02') is requested. Only when the length code is greater than X'0005' can the operator select from the keyboard the attribute value to be associated with the keyed data as shown in bytes 5 and 6, above.
2. If color selection (X'42') is specified, the structured field is accepted, but the operator is not allowed to select color attributes from the keyboard.
3. X'41', X'42', X'43' can appear in any order – not necessarily as shown in bytes 5, 6, and 7 above.
4. If no partition exists with the specified PID, the function is rejected with a negative response (SNA) or Op Check (non-SNA).

Reset Partition Structured Field Format

The *reset partition* structured field resets the reply mode of the specified partition to field mode.

Byte	Content	Meaning
0, 1	X'0004'	Length of structured field in bytes
2	X'00'	Reset-partition ID code
3	PID	Partition identifier

If a partition with the specified PID does not exist, the structured field is rejected with a negative response (SNA) or an Op Check (non-SNA).

ERASE/RESET Structured Field Format

The *erase reset structured* field resets the 3290 to implicit partition state and creates an implicit partition 0 of default or alternate size, as specified in the structured field. Inbound-reply mode is reset.

Byte	Content	Meaning
0, 1	X'0004'	Length of structured field in bytes
2	X'03'	Erase/Reset ID code
3	Size X'00' X'80'	Size of usable area: Default size Alternate size

If byte 3 contains any value other than X'00' or X'80', the structured field is rejected with a negative response (SNA) or an Op Check (non-SNA).

Outbound 3270DS Structured Field Format

The *outbound 3270DS* structured field is used to direct the write commands to a specified partition. The write commands are:

- Write
- Erase/Write
- Erase/Write Alternate
- Erase All Unprotected.

Byte	Content	Meaning
0, 1	L	Length of structured field in bytes
2	X'40'	Outbound 3270DS ID code
3	PID	Partition identifier
4	Wrt Cmd X'F1' X'F5' X'7E' X'6F'	Write-type command code Write Erase/Write Erase/Write Alternate Erase All Unprotected
The remaining bytes of the structured field are the same as for the specified write command.		

WCC bit 1 set to 1 does not reset the 3290 to implicit partition state, as it does for the non-structured-field command, but resets the reply mode of the inbound partition to field mode. WCC bit 4 set to 1 specifies Start Print and must be in the last structured field of the string of structured fields.

Read Partition Structured Field Format

Byte	Content	Meaning
0, 1	X'0000' X'0005'	Length of structured field in bytes
2	X'01'	Read-partition ID code
3	PID	Partition identifier X'00' — X'0F': read operations X'FF' (physical terminal): query operations
4	Type X'02' X'6E' X'F2' X'F6'	Query (used in both implicit partition and explicit partitioned state) Read Modified All (RMA) Read Buffer (RB) Read Modified (RM)

Restrictions:

1. Must be the last structured field in the current outbound transmission.
2. 3290 must be in normal-read state, and PID must specify a valid partition.

Any of the following conditions causes an error and the return of an appropriate sense code in SNA or of Op-Check in non-SNA:

- The 3290 display is in normal-read state, and the identified partition does not exist; sense code X'1005'.
- The command code is invalid; sense code X'1003'.
- The PID value is invalid; sense code X'1005'.
- The read-partition function is not the last structured field to be sent in the current outbound transmission; sense code X'1005'.
- The 3290 is in retry state; sense code X'0871'.
- The transmission is sent with end bracket; sense code X'0829'.
- The transmission does not specify "Change Direction"; sense code X'0829'.

Inbound 3270 Data Stream

All inbound 3270 data streams are preceded by an attention identifier (AID) byte that identifies the cause of the inbound transmissions. The following table lists the possible causes of an inbound 3270 data stream, the associated AID values, and the resulting operations when the 3290 is in normal-read state or in retry state.

Cause	Aid	Operation (Normal-Read State)	Operation (Retry State)
Clear key	X'6D'	Short read (implicit partition 0)	X ? + displayed in operator information area
☐ key (explicit partitioned state only)	X'6A'	Short read (active partition)	
PA1 key	X'6C'	Short read (active partition or screen)	
PA2 key	X'6E'	Short read (active partition or screen)	
PA3 key	X'6B'	Short read (active partition or screen)	
PF1—PF9 keys	X'F1'—X'F9'	Read modified (active partition or screen) (Addresses and data of all modified fields — nulls suppressed)	
PF10—PF12 keys	X'7A'—X'7C'		
PF13—PF21 keys	X'C1'—X'C9'		
PF22—PF24 keys	X'4A'—X'4C'		
Cursor-select field with & designator or Enter key	X'7D'		
Cursor-select field with null or space designator	X'7E'	Read modified (active partition or screen) (Addresses of modified fields)	
Read Modified command	X'60'	Read modified (partition 0)	Retry last AID action from inbound partition
Read Modified All command	X'60'	Read modified all (partition 0)	Retry read modified all from inbound partition

Cause	Aid	Operation (Normal-Read State)	Operation (Retry State)
Read Buffer command	X'60'	Read buffer (partition 0)	Retry read buffer from inbound partition
Read Partition—Modified SF	X'61'	Read modified (partition 0 only, if in implicit partition state)	Reject — Negative Response (SNA) or Op Check (non-SNA)
Read Partition—Read Modified All SF	X'61'	Read modified all (partition 0 only, if in implicit partition state)	
Read Partition—Read Buffer SF	X'61'	Read buffer (partition 0 only, if in implicit partition state)	
Read Partition—Query SF	X'88'	Query replies	

Inbound 3270 Data Stream for Partition 0

Each inbound 3270 data stream for (implicit or explicit) partition 0 is preceded by an AID code that identifies the cause of this inbound data stream.

The preceding chart lists each cause, the AID associated with that cause, and the resulting type of inbound operation. The types of inbound operations are:

- Short read
- Read modified
- Read modified all
- Read buffer.

Short Read Format

The short-read operation results in an inbound data stream consisting of only the AID byte.

Byte	Content	Meaning
0	AID X'6D' X'6A' X'6C' X'6E' X'6B'	Attention-identifier byte: CLEAR key ☐ key (Clear partition key — effective only in explicit partitioned state) PA1 key PA2 key PA3 key

Read Modified and Read Modified All Format

The read-modified operation and the read-modified-all (SNA only) operation can take place in a *field*, an *extended field*, or a *character* reply mode. The following is a general format for all three reply modes.

Byte	Content	Meaning
0	AID	Attention-identifier byte.
1, 2	CCP	Hexadecimal address of the cursor (current cursor position).
3	X'11'	SBA order code.
4, 5	X'——'	Hexadecimal address of the first character in the modified field (attribute address +1).
6— <i>n</i>	Data	Data from the addressed field (including graphic escape/APL character pairs where appropriate) but with null characters suppressed. See Notes 1 and 2.
The pattern of bytes 3 through <i>n</i> is repeated for all other modified (MDT bit set to 1) fields.		

Notes:

1. In character reply mode, the string of data characters can also include Set Attribute orders to indicate changes in the character attribute value.
2. For the read-modified operation, with an AID of X'7E' (indicating cursor selection of a space or null designator character), only the addresses of modified fields are transmitted.
3. If none of the fields has been modified, the inbound data stream consists of bytes 0 through 2, only.
4. If the partition buffer is unformatted, the data stream consists of bytes 0 through 2 and bytes 6 through *n* (all data in the partition buffer, with nulls suppressed).

Read Buffer Format

The read-buffer operation can take place in *field*, *extended field*, or *character* reply mode. The read-buffer operation transmits the contents of all buffer locations in the presentation space, starting at the current cursor position.

Read Buffer Format in Field Reply Mode

Byte	Content	Meaning
0	AID	Attention-identifier byte.
1, 2	CCP	Hexadecimal address of the cursor (current cursor position).
3— n	Data	Data characters (including graphic escape/APL character pairs, where appropriate, and null characters, but excluding Set Attribute orders), starting at the current cursor position to the start of the next field. (See Note.)
$n+1$	X'1D'	Start Field order code.
$n+2$	X'—'	Field-attribute character.
m	Data	All data characters to the start of the next field.
The pattern of bytes $n+1$ through m is repeated for all other fields being transmitted.		

Note: Set Attribute orders are defined in *IBM 3270 Information Display System 3274 Control Unit Description and Programmer's Guide*, GA23-0061.

Read Buffer Format in Extended Field and Character Mode

Byte	Content	Meaning
0	AID	Attention-identifier byte.
1, 2	CCP	Hexadecimal address of the cursor (current cursor position).
3— n	Data	Data characters (including graphic escape/APL character pairs, where appropriate, and null characters), starting at the current cursor position to the start of the next field.
$n+1$	X'29'	Start Field Extended order code.
$n+2$	ATTC	Attribute count (X'00' through X'04'). The number of attribute specifications (byte pairs) that follow. Byte pairs are transmitted only for those extended field attributes with specified (nondefault) values.
	X'CO'	Field-attribute type.
	X'—'	Field-attribute value.
	X'—'	Extended-field-attribute type.
	X'—'	Extended-field-attribute value: includes highlighting, color, and PS. (See "Attributes.")
m	Data	All data characters to the start of the next field
The pattern of bytes $n+1$ through m is repeated for all other fields being transmitted.		

Notes:

1. Set Attribute orders are defined in *IBM 3270 Information Display System 3274 Control Unit Description and Programmer's Guide*, GA23-0061.
2. When in character mode, each string of DATA characters can include Set Attribute orders to indicate changes in the character attribute value. The format for these Set Attribute orders is the same as for outbound Set Attribute orders. In extended-field mode, no Set Attribute orders are included.

Inbound Structured Fields

The inbound structured field AID code (X'88') precedes and identifies the following inbound structured fields for transmission to the host program.

Inbound Structured Field	ID Code (EBCDIC - Hex)
Inbound 3270DS (partitions 01-0F) (Short read) (Read modified) (Read modified all) (Read buffer)	80
Query reply	81
Usable area	81
Partitions	84
Character sets	85
Color	86
Highlight	87
Reply modes	88
Implicit partition	A6

Inbound 3270DS Structured Field Format for Partitions 01 through 0F

The inbound 3270DS structured field is preceded by an AID code (X'88') to identify an inbound structured field.

Byte	Content	Meaning
0, 1	X'0000'	Length of structured field in bytes
2	X'80'	Inbound 3270DS ID code
3	PID	X'01' through X'0F'
4-n		Same as for partition 0 inbound operation for the appropriate operation (bytes 0-n or m): Short read Read modified Read modified all Read buffer

Query Reply Structured Field

The logical terminal to which the read partition query function was addressed responds with the transmission of a series of structured fields indicating the field and character attributes, the screen or page size characteristics, the symbol sets, and the reply modes available on the logical terminal. Since each structured field contains its own unique identification, the order in which the fields are transmitted is not important. The *query reply* structured fields and their associated reply codes are as follows:

Query Reply Structured Field	Reply Code (EBCDIC - Hex)
Query reply	81
Usable area	81
Partitions	84
Character sets	85
Color	86
Highlight	87
Reply modes	88
Implicit partition	A6

Usable Area Query Reply Structured Field Format

The *usable area query reply* structured field indicates to the host program the dimensions of the logical screen for the logical terminal.

Byte	Content	Meaning				
0, 1	L X'001B' X'0017'	Length of structured field in bytes, if: Partitions supported (8 or 16 partitions defined) Partitions not supported (0 partitions defined)				
2	X'81'	Query-reply ID code				
3	X'81'	Usable-area-reply ID code				
4	X'01' X'03'	12- or 14-bit addressing allowed—logical terminal does not support partitions. 16-bit addressing allowed—logical terminal supports partitions				
5	X'20' X'A0'	Variable-character cells not supported (omit bytes 23—26) per logical-terminal definition table Variable-character cells supported (include bytes 23—26) per logical-terminal definition table				
6, 7	LSW X'03C0' X'01E0'	Width of usable screen (in PELs) for logical screen: for <table style="display: inline-table; border: none;"><tr><td style="border: 1px solid black; width: 15px; height: 15px;"></td><td style="border: 1px solid black; width: 15px; height: 15px;"></td></tr></table> screen splits (960 PELs) for <table style="display: inline-table; border: none;"><tr><td style="border: 1px solid black; width: 15px; height: 15px;"></td><td style="border: 1px solid black; width: 15px; height: 15px;"></td></tr></table> screen splits (480 PELs)				
8, 9	LSH X'02EF' X'0177'	Height of usable screen (in PELs) for logical screen: for <table style="display: inline-table; border: none;"><tr><td style="border: 1px solid black; width: 15px; height: 15px;"></td><td style="border: 1px solid black; width: 15px; height: 15px;"></td></tr></table> screen splits (751 PELs) for <table style="display: inline-table; border: none;"><tr><td style="border: 1px solid black; width: 15px; height: 15px;"></td><td style="border: 1px solid black; width: 15px; height: 15px;"></td></tr></table> screen splits (375 PELs)				
10	X'01'	Units of measure (millimeters)				
11—14	X'0005 000E'	Horizontal pitch of PELs				

Byte	Content	Meaning
15—18	X'0005 000E'	Vertical pitch of PELs
19	HS	Horizontal character cell size as defined (X'06' if not defined — 00 in logical-terminal definition)
20	VS	Vertical character cell size as defined (X'0C' if not defined — 00 in logical terminal definition)
21, 22	X'0000'	Character buffer size for unpartitioned logical terminal
23	X'06'	Minimum horizontal PELs that can be specified in Create Partition
24	X'0C'	Minimum vertical PELs that can be specified in Create Partition
25	X'0C'	Maximum horizontal PELs that can be specified in Create Partition
26	X'1F'	Maximum vertical PELs that can be specified in Create Partition

Partitions Query Reply Structured Field Format

The *partitions query reply* structured field is transmitted to the host program only when 8 or 16 partitions are defined in the logical-terminal definition table for the logical terminal. In this case, it also provides information on whether the creation of a scroll buffer is permitted and its maximum permissible size.

The partitions query reply is transmitted inbound by the 3290 as a structured field with the format shown. The partitions query reply indicates to the host the total number of partitions allowed and the total storage available for all partitions.

Byte	Content	Meaning
0, 1	X'0008'	Length of structured field in bytes
2	X'81'	Query-reply ID code
3	X'84'	Partitions-reply ID code
4	X'08' or X'10'	Maximum number of partitions defined in the logical-terminal definition table
5, 6	X'——'	Total available partition storage
7	FLAGS X'00' X'80' X'04' X'84' All others	Vertical scrolling not defined; host-initiated local copy of presentation space not supported. Vertical scrolling defined; host-initiated local copy of presentation space not supported. Vertical scrolling not defined; host-initiated local copy of presentation space supported. Vertical scrolling defined; host-initiated local copy of presentation space supported. Reserved.

Notes:

1. The maximum partition size is attainable only for a single partition.
2. Byte 4: The value inserted in byte 4 is obtained from the number of partitions defined in the logical-terminal definition table.
3. Bytes 5 and 6: If the value in the scroll-enabled column of the logical-terminal definition table is 0, the value inserted in bytes 5 and 6 is equal to the largest number of smallest-size characters that can be written on the terminal screen. If the scroll-enabled value is 1, the value inserted in bytes 5 and 6 is the amount of scrollable character storage.
4. Byte 7, bit 0: This bit is set to *b1* if the logical-terminal definition table has a 1 in the scroll-enabled column. Otherwise, it is set to *b0*.
5. Byte 7, bit 5: This bit is set to *b0* if the communication attachment is non-SNA, and to *b1* if the communication attachment is SNA.

Self-Defining Parameter

The following self-defining parameter is included as part of the partitions query reply structured field.

Byte	Content	Meaning
0	X'07'	Length of parameter
2	X'02'	Storage allocation parameter
2	CM	Bytes required for each position defined by (H x W) of the create-partition structured field: = 2 for EAB = 1 for non-EAB
3	R0	Overhead (bytes) per partition row
4	X'00'	Overhead (bytes) per partition column
5, 6	X'0000'	Fixed overhead required per partition

Notes:

1. Byte 2: The character multiplier defines the bytes of storage required for each position defined by (HxW) of the create partition structured field.
2. Byte 3: The Row overhead defines the overhead storage bytes required per partition row.
3. Byte 4: The Column overhead defines the overhead storage bytes required per partition column.
4. Bytes 5 and 6: The fixed overhead defines the fixed-storage bytes required per partition in addition to row and column.

Character Sets Query Reply Structured Field Format

The *character sets query reply* structured field is transmitted to inform the host program what character sets are defined for the logical terminal.

Byte	Bit	Content	Meaning
0, 1	—	L	Length of structured field in bytes (13+ lengths of descriptors)
2	—	X'81'	Query-reply ID code
3	—	X'85'	Character-sets-reply ID code
4	—	Flags	Based on logical-terminal definition table (EAB/PS) definition:
	0	0 or 1	Graphic escape (EAB) supported (0=no; 1=yes)
	1	0	Reserved
	2	0 or 1	Load PS (EAB and PS) supported (0=no; 1=yes)
	3	0 or 1	Load PS extension (EAB and PS) supported (0=no; 1=yes)
	4	1	More than one size of character cell supported.
	5—7	000	Reserved
5	—	X'00'	Reserved
6	—	X'09'	Default-character cell width in PELs
7	—	X'10'	Default-character cell depth in PELs
8—11	—	X'6000 0000'	Load PS types 1 and 2 supported (EAB and PS defined)
		X'0000 0000'	Load PS not supported (EAB and PS not defined)
12	—	X'05'	Length of character-set descriptors

This structure is followed by an appropriate number of 5-byte descriptors, one for each character set supported and, if a character set has two sizes of character, one for each size. The format for the descriptors follows.

Character Sets Descriptor Format

The following descriptor format is used for each size of each character set supported.

Byte	Bit	Content	Meaning
1		X'00' X'07'	Device—specific character set ID
2	0	0 or 1	Loadable character set (1 = Yes, 0 = No)
	1	0	Single—plane character set—must be zero
	2	0	One—byte coded character set—must be zero
	3	0 or 1	LCID compare — B'0'; LCID not comp — B'1'
	4—7	0000	Reserved—must be all zeros
3		LCID	Local character set ID (X'00' for base character set, X'F1' for APL character set)
4		SW	Character set slot width
5		SH	Character set slot height

Reply Modes Query Reply Structured Field Format

The *reply modes query reply* structured field is transmitted, if EAB is defined, to inform the host program which reply modes are supported by the logical terminal.

Byte	Content	Meaning
0, 1	X'0007'	Length of structured field in bytes
2	X'81'	Query reply ID code
3	X'88'	Reply modes reply ID code
4	X'00'	Field reply mode supported
5	X'01'	Extended—field reply mode supported
6	X'02'	Character reply mode supported

Color Query Reply Structured Field Format

The *color query reply* structured field indicates to the host the color (orange) that will be displayed for each of the color attribute values.

Byte	Content	Meaning
0, 1	X'0016'	Length of this structured field in bytes
2	X'81'	Query-reply ID code
3	X'86'	Color-reply ID code
4	X'00'	Reserved
5	X'08'	Length of attribute list (number of color attribute pairs)
6	X'00'	Default color attribute
7	X'FA'	Orange is the device default color
8—21	X'F100F2 00F300 F400F5 00F600 F700'	Color attribute X'F1' — X'F7' default to device color X'FA'

Notes:

1. Bytes 6 and 7 are always used to indicate the 3290 default color.
2. If *extended attributes* is not enabled by the logical-terminal definition table, the color query reply is not returned.

Highlight Query Reply Structured Field Format

The *highlight query reply* is transmitted inbound as a structured field with the format shown.

Byte	Content	Meaning
0, 1	X'000D'	Length of this structured field in bytes
2	X'81'	Query-reply ID code
3	X'87'	Highlight-reply ID code
4	X'04'	Number of byte pairs that follow
5	X'00'	Acceptable attribute value
6	X'F0'	Default-highlight action code
7	X'F1'	Accepted attribute value
8	X'F1'	Blink action code
9	X'F2'	Accepted attribute value
10	X'F2'	Reverse action code
11	X'F4'	Accepted attribute value
12	X'F4'	Underscore action code

Notes:

- Bytes 5, 7, 9, and 11 of a highlight query reply indicate to a host the attribute values that the 3290:
 - Can accept in an outbound extended-highlight attribute byte
 - Will preserve and will return to the host in a subsequent inbound operation (unless changed by the operator).
- Bytes 6, 8, 10, and 12 indicate to a host what action the 3290 performs for each of those attribute values.
- If *extended attributes* is not enabled by the logical-terminal definition table, the highlight query reply is not returned.

Implicit Partition Query Reply Structured Field Format

The *implicit partition query reply* structured field is always returned by the 3290 logical terminal. It informs the host of the default and alternate sizes for the target logical terminal's implicit partition. It may also return the cell size in effect for the default and alternate screen sizes.

Byte	Content	Meaning
0, 1	L	Length of structured field (in bytes)
2	X'81'	Query-reply ID code
3	X'A6'	Implicit-partition-reply ID code
4, 5	X'0000'	Reserved

Implicit Partition Default and Alternate Screen Size

For SNA, the default and alternate screen sizes returned in this reply are those established at BIND to this logical terminal.

For non-SNA, the default and alternate screen sizes returned in this reply are those in effect for this logical terminal at the time the reply is generated.

Character Cell Dimensions

The dimensions of the character cells in effect for the default and alternate screen sizes are returned only when the character cell size for either the default or the alternate implicit partition is different from the cell size specified in the usable area query reply.

Self-Defining Parameters

The following implicit partition size parameter is always returned as part of the implicit partition query reply.

Byte	Content	Meaning
0	L	Length of parameter (in bytes)
1	X'01'	Screen-size-dimensions parameter
2	X'00'	Reserved
3, 4	WD	Width of default screen size in cells
5, 6	HD	Height of default screen size in cells
7, 8	WA	Width of alternate screen size in cells
9, 10	HA	Height of alternate screen size in cells

Notes:

1. Bytes 3 and 4: For SNA, the width of the default implicit partition is the value established at logical-terminal BIND time. For non-SNA, the width of the default implicit partition is 80.

2. Bytes 5 and 6: For SNA, the height of the default implicit partition is the value established at logical-terminal BIND time. For non-SNA, the height of the default implicit partition is 24.
3. Bytes 7 through 10: For SNA, the width and the height of the alternate implicit partition are the values established at logical-terminal BIND time. For non-SNA, the width and the height of the alternate implicit partition are the values defined in the logical-terminal definition table.

The following parameter is returned only when the character cell size for either the default or the alternate screen is different from the cell size specified in the AW and AH parameters of the usable area query reply.

Byte	Content	Meaning
0	L	Length of parameter (in bytes)
1	X'02'	Character-cell-dimensions parameter
2	X'00'	Reserved
3, 4	WCD	Width of character cell for default screen size
5, 6	HCD	Height of character cell for default screen size
7, 8	WCA	Width of character cell for alternate screen size
9, 10	HCA	Height of character cell for alternate screen size

Note: For bytes 3 through 10, values are calculated dynamically at the time the implicit partition query reply is generated. The values are based upon the size of the logical terminal's usable area, and upon the number of vertical and horizontal cells in the partition.

Transmission of Buffer Addresses

The following text describes:

1. The relationship between a given row/column position in a partition's presentation space and its address in the partition's buffer storage.
2. How a buffer storage address is transmitted to and from the 3290 in each of the two address modes.

Buffer Addresses

The relationship between any given row/column position in a partition and its address in the partition's buffer storage is expressed thus:

$$\text{Buffer address} = W \times (R-1) + (C-1)$$

Where:

- W is the partition *width* (number of columns)
- R is the *row number* (counting from 1) of the position being addressed
- C is the *column number* (counting from 1) of the position being addressed.

Note: For column 1, row 1, the buffer address is 0.

Example of Buffer Address Calculation

Given a partition width (W) of 50 columns, what is the buffer address of the character location in column 46 and row 21?

$$\text{Buffer Address} = (50 \times 20) + 45 = 1045$$

Transmission of a Buffer Address

A buffer address is always transmitted in a 2-byte field.

The way in which a buffer address is transmitted (for example, in the two bytes after the X'11' byte in a Set Buffer Address order, or in the two bytes that specify the current cursor position in an inbound read operation) depends on the *address mode for the partition*.

A partition has one of two address modes:

- 16-bit address mode
- 12/14-bit address mode.

An implicit partition 0 (that is, when the 3290 is in implicit partition state) always has a 12/14-bit address mode; in all other cases, a partition's address mode is established in the *create partition* structured-field function.

Transmission of Buffer Address in 16-Bit Address Mode

In 16-bit address mode, buffer addresses are transmitted outbound and inbound as 16-bit binary numbers.

Transmission of Buffer Address in 12/14-Bit Address Mode

In 12/14-bit address mode, bits 0 and 1 of the first address byte have the following bit significance:

- 00 – 14-bit binary address follows
- 01 – 12-bit coded address follows
- 11 – 12-bit coded address follows

(In an outbound transmission, if bits 0 and 1 of the first byte are set to B'10', then a sense code of X'1005' is returned.)

For outbound transmissions, 3290 uses these first two bits to determine whether the address in the transmission is 12-bit or 14-bit. For inbound transmissions, the size of the partition determines whether the address transmission is 12-bit or 14-bit. If the partition size is greater than 4096 bytes (excluding character attributes if an EAB device), 14-bit addresses are used. Otherwise, 12-bit addresses are used.

14-Bit Addresses: 14-bit buffer addresses are transmitted outbound and inbound with bits 0 and 1 of the first byte equal to B'00', followed by the buffer address expressed as a 14-bit binary number.

12-Bit Addresses: 12-bit buffer addresses are transmitted outbound and inbound with the following format:

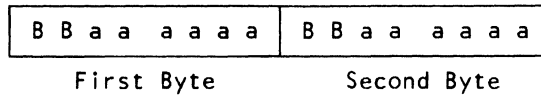

Where:

a represents the binary value of the address (12 bits), and *BB* is B'01' or B'11' (see text below).

The 12-bit address EBCDIC values for decimal addresses 0 through 10879 are derived as follows:

1. The 12-bit binary representation of the decimal address is split into two 6-bit groups.
2. The more significant 6-bit group occupies bits 2 through 7 of the first byte.
3. The less significant 6-bit group occupies bits 2 through 7 of the second byte.
4. According to the value of bits 2 through 7 in each byte, bits 0 and 1 of each byte are set to obtain the hexadecimal representations, as defined in the table below. The resulting EBCDIC value represents a graphic character in the range X'40' through X'F9'.

Bits 2—7	EB*	Bits 2—7	EB*	Bits 2—7	EB*	Bits 2—7	EB*
00 0000	40	01 0000	50	10 0000	60	11 0000	F0
00 0001	C1	01 0001	D1	10 0001	61	11 0001	F1
00 0010	C2	01 0010	D2	10 0010	E2	11 0010	F2
00 0011	C3	01 0011	D3	10 0011	E3	11 0011	F3
00 0100	C4	01 0100	D4	10 0100	E4	11 0100	F4
00 0101	C5	01 0101	D5	10 0101	E5	11 0101	F5
00 0110	C6	01 0110	D6	10 0110	E6	11 0110	F6
00 0111	C7	01 0111	D7	10 0111	E7	11 0111	F7
00 1000	C8	01 1000	D8	10 1000	E8	11 1000	F8
00 1001	C9	01 1001	D9	10 1001	E9	11 1001	F9
00 1010	4A	01 1010	5A	10 1010	6A	11 1010	7A
00 1011	4B	01 1011	5B	10 1011	6B	11 1011	7B
00 1100	4C	01 1100	5C	10 1100	6C	11 1100	7C
00 1101	4D	01 1101	5D	10 1101	6D	11 1101	7D
00 1110	4E	01 1110	5E	10 1110	6E	11 1110	7E
00 1111	4F	01 1111	5F	10 1111	6F	11 1111	7F

Note: The 12-bit address EBCDIC values for decimal addresses 0 through 3563 are listed in the *IBM 3270 Information Display System Buffer Address Codes*, GA23-0057.

* EB = EBCDIC



Chapter 5. 3290 Controls and Indicators

This chapter describes the purpose and function of the controls, switches, and indicators necessary to make the 3290 operative. The first section of the chapter describes the 3290 controls:

- On/Off switch
- On indicator
- Security keylock
- Test switch
- Tilt control lever
- Audible alarm control.

The locations of these controls on the 3290 are shown in Figure 5-1.

The second section of the chapter describes the indicators that you may see in the operator information area while using the 3290. It also describes, where necessary, what you should do when you see a particular indicator or set of indicators.

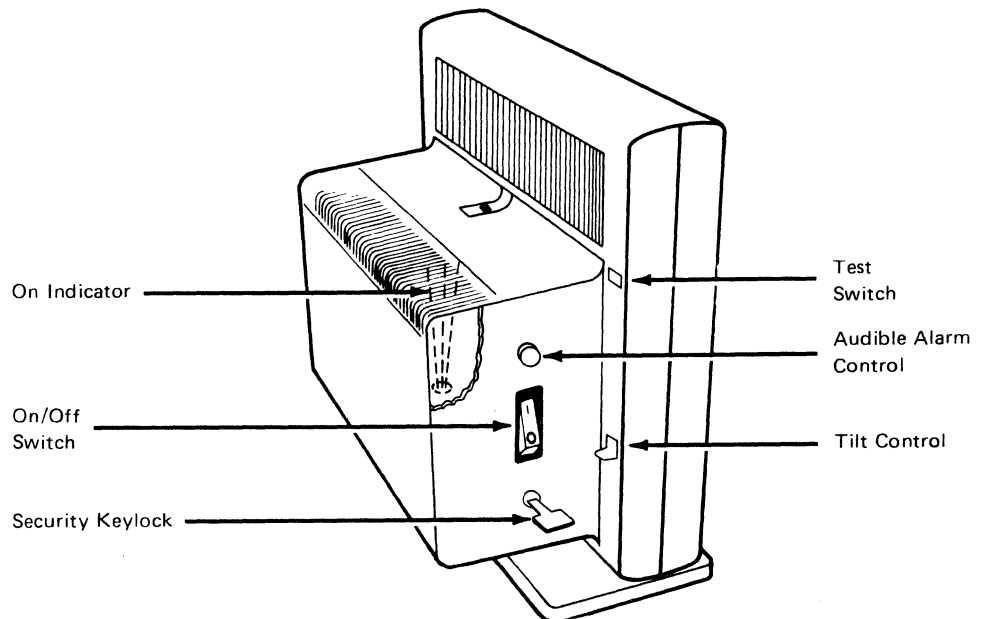
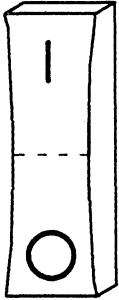

Figure 5-1. 3290 Controls

3290 Controls

On/Off Switch



Applies power to your 3290.

Each time you press the On/Off switch to the On (|) position, power is applied to the electrical circuits of your 3290. This action causes the Basic Assurance Test sequence to be automatically executed.

When the 3290 is powered on, the following sequence normally occurs:

1. Two broad horizontal traces momentarily appear at the top of the panel and descend vertically toward the bottom. This is a normal event and should not be considered a malfunction.
2. The separator line appears approximately one-half inch from the bottom of the panel.
3. The Basic Assurance Test sequence starts, and the test routine numbers appear in the operator information area to signal the start of each test.
4. When the tests finish, the Downstream Loading sequence starts, and a appears in the operator information area.
5. When the Downstream Loading sequence is completed, a appears in the operator information area. If fails to appear within two minutes after you switch on the 3290, refer to *IBM 3270 Information Panel, Customer Problem Analysis and Resolution*, GA23-0125.

Note: If <2> appears in the operator information area, refer to "Setup Functions" in Chapter 3.

On Indicator

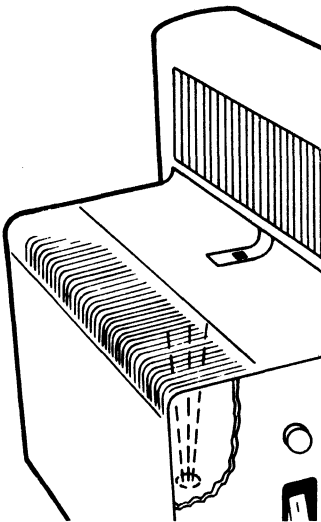

Indicates power is applied to your 3290.

You can see the ON indicator by looking down through the top of the logic element. When you press the On/Off switch to the On (|) position, the indicator glows red. This signifies that power has been applied to the electrical circuits of your 3290.

If the indicator is blinking, there is a problem with your 3290. Refer to *IBM 3270 Information Panel, Customer Problem Analysis and Resolution*, GA23-0125.

Security Keylock

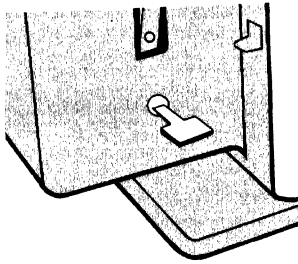

Allows you to prevent unauthorized personnel from using the 3290.

The security keylock on the 3290 provides you with a means of security. Your 3290 cannot accept operator input until someone inserts the key and turns it clockwise (↻) 90 degrees.

The key must remain in the operating position as long as you wish to operate your 3290. The key cannot be removed while in the operating position. If you turn the key counterclockwise (↺), the screen is erased except for the operator information area. ✕ appears in the operator information area, and data entry is inhibited. When the keylock is returned to the On position, data appears on the screen and you are ready to resume operation.

Test Switch

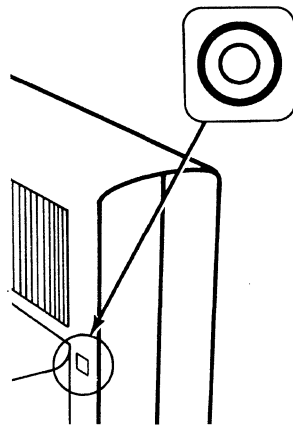

Produces a test pattern on your panel.

You use the Test switch to produce a test pattern on your panel. This test pattern verifies the presence or absence of picture elements (PELs) that form the individual characters on your panel. Holding the Test switch down produces continuous test patterns.

CAUTION

If data exists on your panel and you press this switch, the data disappears and a test pattern replaces it. Data that you previously entered may be lost.

Normally, when you press this switch, the test pattern appears for approximately 20 seconds; then the 3290 goes through the downstream load sequence as it did when you pressed the On/Off switch to the On (|) position. If the test pattern remains on the panel, press the On/Off switch to the Off (O) position, and then to the On (|) position.

If you are having problems with malformed or distorted characters on your 3290, refer to *IBM 3270 Information Panel, Customer Problem Analysis and Resolution*, GA23-0125.

Tilt Control Lever

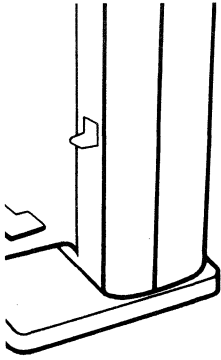

Adjusts the angle of your panel.

The tilt control lever allows you to adjust the angle of your panel for comfortable viewing or for minimal glare. To tilt the panel, lift and hold the tilt control lever with one hand while holding the panel with the other hand. Move the panel forward or backward until you achieve the desired tilt angle. Release the tilt control lever to lock the panel at the desired angle.

Audible Alarm Control

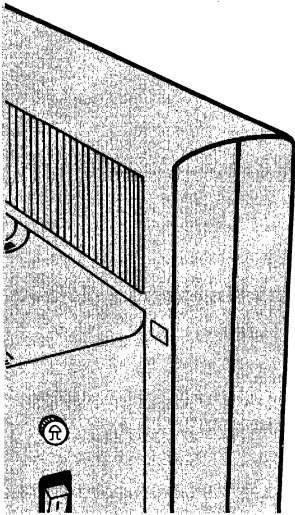

Adjusts the volume of the audible alarm.

The alarm is activated, under program control, to alert you to a special condition. The audible alarm also sounds when you enter a character into the *next-to-last* position of the active partition, if the cursor stops at the *last* position. You can adjust the volume level of the alarm:

- To increase the volume, turn the alarm control clockwise (↻).
- To decrease the volume, turn the alarm control counterclockwise (↺).

3290 Indicators

This section describes the message indicators that you may see in the operator information area of the panel. It also describes, where necessary, what you should do when you see a particular indicator or set of indicators.

The operator information area is the bottom line of your display panel. The horizontal separator line separates this area from the display space. The operator information area displays operating and status indicators that are associated with your 3290 operation. These indicators are displayed as symbols, words, and numerals. Examples of associated symbols and meanings follow:

✕ Do Not Enter (Input Inhibited)

⌚ Time is required

□ Display or printer unit

Indicators may be composed of groups of symbols. Examples of associated groups of symbols and meanings follow:

✕ ⌚ Do Not Enter, because time is needed for the host system to perform a function.

✕ □ ✕ Do Not Enter, because your printer is not operating properly.

□ □ 06 Your 3290 is connected to printer 06.

□ ✕ 06 Printer 06 stopped while printing data from your 3290.

In addition to displaying operation and status indicators during normal operation, the operator information area is used in setup mode and copy-screen mode. For an explanation of the information that appears while in these modes, refer to Chapter 3, "3290-Unique Functions."

The indicators in the operator information area are grouped from left to right in this order:

- Readiness and System Connection
- Do Not Enter
- Communication Error Reminder
- Program Symbol Selection
- Character Selection
- Shift Selection
- Highlight Selection
- Insert
- Printer Status
- Image Limit
- Logical Terminal Identifier
- Row/Column Position

Quick Reference

The following table defines each indicator and refers to the page where it is discussed.

Symbol	Meaning	Page
A	Online (non-SNA)	5-8
B	Online (SNA)	5-8
Ⓜ	Ready	5-8
<n>	Setup	5-8
□→?	Copy Screen	5-8
TEST	Test	5-8
Ⓜ	System Operator	5-9
■	My Job	5-9
Ⓜ	Unowned	5-9
✕ Ⓜ	Do Not Enter – Security Key	5-10
✕ Ⓜ nnn	Do Not Enter – Machine Check	5-10
✕ Ⓜ 5nn	Do Not Enter – Communication Check	5-10
✕ Ⓜ	Do Not Enter – Printer Not Working	5-10
✕ Ⓜ	Do Not Enter – Printer Busy	5-11
✕ Ⓜ	Do Not Enter – Printer Very Busy	5-11
✕ PROG7nn	Do Not Enter – Program Check	5-11
✕ ?+	Do Not Enter – What ?	5-12
✕ Ⓜ	Do Not Enter – Terminal Wait	5-12
✕ -f	Do Not Enter – Minus Function	5-12
✕ -f Ⓜ	Do Not Enter – Minus Function – Operator Unauthorized	5-12
✕ Ⓜ>	Do Not Enter – Too Much Entered	5-13
✕ ⓂNUM	Do Not Enter – Numeric Data Only	5-13
✕ Ⓜ+? ✕ Ⓜ+? ✕ Ⓜ^+? ✕ Ⓜ'+? ✕ Ⓜ,+?	Do Not Enter – Invalid Dead-Key Combination (Canadian-Bilingual and French Keyboards Only)	5-13
✕ Ⓜ→	Do Not Enter – Go Elsewhere	5-14
✕ Ⓜ→	Do Not Enter – Partition Wait	5-14
✕ SYSTEM	Do Not Enter – System Lock	5-14
✕ Ⓜ#?	Do Not Enter – What Number	5-14
✕ Ⓜ	Do Not Enter – Operator Unauthorized	5-15
Ⓜ 5nn	Communication Error Reminder	5-15

Symbol	Meaning	Page
FSA PSB FSC PSD PSE PSF	Programmed Symbol Set (A through F) (Field-Defined)	5-15
SO ▶	Nonloadable Character Set (Field Inherit)	5-15
FSA ▶ PSB ▶ FSC ▶ PSD ▶ PSE ▶ PSF ▶	Programmed Symbol Set (A through F) (Field Inherit)	5-16
FSA † PSB † FSC † PSD † PSE † PSF †	Programmed Symbol Set (A through F) (Operator-Selected)	5-16
ALPHA	Alpha	5-16
ｶﾀ	Katakana	5-16
APL	APL	5-16
NUM	Numeric	5-17
↑	Upshift	5-17
a ▶	Normal — No highlighting (Field Inherit)	5-17
◉ ▶	Blink Highlighting (Field Inherit)	5-17
◻ ▶	Reverse Video Highlighting (Field Inherit)	5-18
⏟ ▶	Underscore Highlighting (Field Inherit)	5-18
◉ †	Blink Highlighting (Operator-Selected)	5-18
◻ †	Reverse Video Highlighting (Operator-Selected)	5-18
⏟ †	Underscore Highlighting (Operator-Selected)	5-18
^	Insert Mode	5-19
□□_	Assign Printer	5-19
□□nn	Printer Assignment	5-19
□■nn	Printer Failure	5-19
□■nn	Printer Printing	5-19
□□??	What Printer	5-19
■→■	Image Limit	5-20
nnnn	Logical Terminal ID	5-20
rrrr/ccc	Row and Column Indicator	5-20

Readiness and System Connection

Online (Non-SNA)

A

SNA is *not* the communication protocol.

The protocol for communication between an application program and your 3290 is *not* systems network architecture (SNA).

Online (SNA)

B

SNA is the communication protocol.

The protocol for communication between an application program and your 3290 is systems network architecture (SNA).

Ready

4

The 3290 is operational.

Your 3290 is operational. This symbol does not appear in setup mode or copy screen mode.

Note: This symbol may appear if the keyboard is not attached or operational.

Setup

<n>

The 3290 is in setup mode.

Setup mode allows you to tailor the information panel to reflect your unique work environment. **n** is a number that indicates setup mode level 1, 2, or 3. Setup mode changes the type of information presented in the operator information area. Refer to "Setup Functions" in Chapter 3 for a description of these changes.

Copy Screen

□→?

The 3290 is in copy screen mode.

The active logical screen can be copied to a copy screen or to a printer. You can also clear a copy screen. Refer to "Copy Screen Mode" in Chapter 3.

Test

TEST

The 3290 is in test mode.

Test mode is used to run diagnostics. Press the Test key to exit test mode if this indicator is displayed.

System Operator



The active logical terminal is connected to the system services control point.

The SSCP-LU session is active.

My Job



The active logical terminal is connected to your job (application).

Unowned



The active logical terminal is communicating with the processor, but not with your job or the system services control point.

The SSCP-LU session is active, but you are not communicating with your application or the SSCP.

Do Not Enter



The Do Not Enter (X) indicator in the operator information area tells you that your 3290 will not accept input from your keyboard or from any other input device attached to your 3290. Additional symbols are shown to the right of the X to explain why your input devices are disabled.

There is no mechanical keyboard lock that prevents you from using the keyboard. Thus, when your keyboard is locked, the keys are not physically locked. You can still press them normally, but, with a few exceptions, they perform no function. (Some keys may cause indicators to change in the operator information area.)

The following keys, however, are usually operational even when the Do Not Enter indicator appears:

Shift	Alternate
Cursor Blink	Alternate Cursor
Clicker	Attention
System Request	Device Cancel
Test	Reset
Change Screen	Jump Screen

Your keyboard contains a clicker that causes a clicking sound when you press a key. You can turn the clicker on or off as described under "Clicker Key" in Chapter 6.

- If the clicker is on, the absence of the click indicates that the keyboard is locked as a result of a do-not-enter condition. An X appears in the operator information area.

- If the clicker is off, the presence of the click indicates that the keyboard is locked as a result of a do-not-enter condition. An **X** appears in the operator information area.

The reasons that **X** appears are discussed in the following descriptions. Each description tells you how, when possible, to turn off the **X** indicator and unlock your keyboard.

Security Key



The security keylock is off.

Your 3290 cannot accept data. Only the operator information area is displayed. Insert the security key in the lock, and turn the key clockwise () to unlock your 3290 and remove the security key indicator.

Machine Check



There is a 3290 error.

Your 3290 was unable to perform an action correctly. nnn is a 3-digit error number that defines the type of machine check. Refer to Appendix B for a list of these numbers and their meaning. Press Reset to remove this indicator and to unlock the keyboard. If this condition persists, refer to *IBM 3270 Information Panel, Customer Problem Analysis and Resolution, GA23-0125*.

Communication Check



There is a problem with the communication line between your 3290 and the host.

This indicator appears when you attempt to communicate with a host and a communication error reminder is present in the operator information area. The error number, 5nn defines the type of communication check. Refer to Appendix B for a list of these error numbers and their meaning. Press Reset to remove this indicator and to unlock the keyboard. If the problem persists, refer to *IBM 3270 Information Panel, Customer Problem Analysis and Resolution, GA23-0125*.

Printer Not Working



Your printer is not functioning.

The printer assigned to your 3290 is not functioning.

This indicator can be caused by any of the following conditions:

- Equipment check
- Intervention required (buffer reprint, forms jam, end of form, hold print time-out, etc.)
- Data check
- Cancel print

Press DvCnl and retry the operation to determine whether the condition is recoverable from the 3290.

If the condition persists, and you initiated the print operation by using the  key, press the DvCnl key to restore the keyboard. Your print request was canceled. You may then either select a different printer, using the IDENT procedure, or try to restore the failing printer. If the print operation was initiated by the host system, the host removes this indicator and unlocks the keyboard. The Reset key has no effect when this message is displayed.

Note: Printer Status symbols may appear in the operator information area to the right of the Do Not Enter group of symbols.

Printer Busy

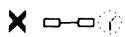

A job is printing on your printer.

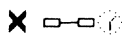
The printer assigned to your 3290 is busy. If Printer Printing () appears with Printer Busy (), your job is printing. You may either (1) wait for your job to finish printing or (2) press the DvCnl key. DvCnl will:

- Cancel your request if it has not started, or cancel the remainder of your job if it has started
- Remove the Printer Busy symbol
- Unlock the keyboard

Note: This symbol may flash on and off whenever you initiate a print operation. The Reset key has no effect when this message is displayed.

Printer Very Busy

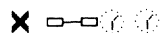

The host is using your printer.

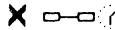
This message means the same thing as the  (Printer Busy) message, except that more time is expected before your print operation is accepted. The Reset key has no effect when this message is displayed.

Program Check



There is an error in the data received from the host.

The 3290 detected a programming error in the data it received from the host processor. This indicator may appear because of an incompatibility between the application program and your 3290.

7nn is a 3-digit error number that defines the type of program check. Refer to Appendix B for a list of these error numbers and their meaning. Press Reset to remove this indicator and to unlock the keyboard.

What ?

✕ ?+

Your last operation was not accepted.

The last operation you tried was not accepted by the 3290. Check your panel to make sure the operation you want to perform is correct. This indicator is displayed for one of the following reasons:

- A Dead key sequence has been aborted
- A do-not-enter condition was present when you tried your last operation
- The 3290 did not accept the last characters you typed.

Press Reset to remove this indicator. Reset may or may not unlock the keyboard.

Terminal Wait

✕ ⌚

Time is required to perform the function you requested.

The host processor or the 3274 needs time to perform the function you requested. You must wait for the function to be completed. Reset will not remove this indicator.

Minus Function

✕ -f

The requested function is not available.

You requested an unavailable function:

- A function not currently supported by your logical terminal
- A request for a local copy while the host is processing data or while a local copy operation is already in progress
- An operation requiring attention from the application program during certain SNA conditions.

Press Reset to remove this indicator and to unlock the keyboard.

Minus Function – Operator Unauthorized

✕ -f ✕

The requested character set or highlighting is not available.

You attempted to select one of the following:

- A character set specified as *output only*
- A character set or highlighting, with the selection not allowed
- A character set from an unavailable programmed symbol set.

Press Reset to remove this indicator and to unlock the keyboard.

Too Much Entered

✘ 𐀀

You attempted to enter more data than allowed in a field.

You tried to enter more data into a field than the field could hold. Press Reset to remove this indicator and to unlock the keyboard.

Numeric Data Only

✘ 𐀁NUM

Non-numeric data is entered in a numeric field.

The Keyboard Numeric Lock feature is active, and you tried to enter a character other than the following into a numeric field:

0 through 9
Decimal sign (.)
Minus sign (-)
Dup

Note: In some countries, the symbol , replaces the symbol . as a decimal sign.

To override the Keyboard Numeric Lock feature, use either shift key.

Press Reset to remove this indicator and to unlock the keyboard.

Invalid Dead-Key Combination (Canadian-Bilingual and French Keyboards Only)

✘ 𐀂+?

Your accent-and-character combination is not acceptable.

✘ 𐀃+?

You have entered an invalid 'accent-and-character' combination, so the accent has become a stand-alone character. Press Reset to remove this indicator and to unlock the keyboard.

✘ 𐀄+?

✘ 𐀅+?

✘ 𐀆+?

To correct the 'accent-and-character' combination, you must reenter the accent. For a description of valid dead-key combinations, refer to "Dead Keys" in Chapter 6.

Go Elsewhere



You tried to enter data in the wrong location.

You tried to do one of the following:



- Enter, insert, erase, or delete a character when the cursor was in a protected field or at a field attribute location.
- Perform a cursor-select operation when the cursor was not in a valid cursor select field. Refer to “Cursor Select Key” in Chapter 6.

Press Reset to remove this indicator and to unlock the keyboard.

Partition Wait



The host needs time to perform the requested function in the active partition.

The host processor needs time to perform the function you requested in the active partition. You cannot key data into that partition while this indicator appears. You can press . If the host accepts this action, the cursor jumps to the next sequential partition.  disappears, allowing you to key data into the new active partition if the new active partition does not contain a do-not-enter indicator.

Should the original partition become active again,  reappears if the partition wait condition still exists.

System Lock

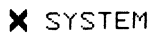

You cannot enter data.

The application program has not unlocked your keyboard after processing your entry. Press Reset to remove this indicator and to unlock the keyboard.

What Number

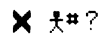

You entered an incorrect printer ID number.

You pressed the Ident key and entered an incorrect printer ID number. For a description of printer ID numbers, refer to “Ident Key” in Chapter 6.

Press Reset to remove this indicator and to unlock the keyboard.

Operator Unauthorized

✕ 𐄂 ✕

Your 3290 is not authorized to do certain printer-related functions.

The following actions can cause ✕ 𐄂 ✕ to appear:

- You initiated a local copy operation, and no printer is assigned, or □-□?? appears.
- You pressed Ident, and no printer is assigned.
- You pressed Ident and entered an unauthorized printer ID.
- You initiated a local copy operation, and the “printer” assigned is actually a 3290 or does not support the SNA character string (SCS) format and no other printers are available.

Press Reset to remove this indicator and to unlock the keyboard.

Communication Error Reminder

Communication Error Reminder

✕ 𐄂 5nn

There is a failure on the data link between your 3290 and the host.

There is a failure on the data link between your 3290 and the host processor. A do-not-enter indicator (✕ 𐄂 5nn) will appear if you try to communicate with the host. The error number 5nn defines the type of communication check. Refer to Appendix B for a list of these error numbers and their meaning.

Programmed Symbol Selection

Programmed Symbol Set (A through F) (Field-Defined)

FSA
PSB
FSC
PSD
PSE
PSF

All characters entered will be displayed from the programmed symbol set specified.

The application program has defined that all characters entered will be displayed from the specified programmed symbol set. You cannot select another symbol set.

Nonloadable Character Set (Field Inherit)

SO 𐄂

All characters entered will be displayed from the nonloadable character set. You can select another set.

The application program has defined that all characters entered will be displayed from the nonloadable character set. The symbol 𐄂 means you can select another symbol set.

Programmed Symbol Set (A through F) (Field Inherit)

FSA ▶	All characters entered will be displayed from the programmed symbol set specified.
PSB ▶	You can select another set.
FSC ▶	
PSD ▶	The application program has defined that all characters entered will be displayed from the specified programmed symbol set. The ▶ symbol means you can select another symbol set.
PSE ▶	
PSF ▶	

Programmed Symbol Set (A through F) (Operator-Selected)

FSA 𑄀	All characters entered will be displayed from the specified programmed symbol set you selected.
PSB 𑄀	
FSC 𑄀	
PSD 𑄀	You have selected the displayed programmed symbol set. All characters entered will be displayed from that set. You can (1) select another symbol set or (2) press ▶ to return to the symbol set that the application program originally specified.
PSE 𑄀	
PSF 𑄀	

Character Selection

These indicators inform you of the shift and mode that your keyboard is presently using.

Alpha

ALPHA This relates to a Katakana keyboard.

The Katakana keyboard is in alphabetic shift. You can type only uppercase English characters in this mode.

Katakana

カタ This relates to a Katakana keyboard.

The keyboard is in Katakana shift.

APL

APL Characters entered from the keyboard are APL.

The keyboard is in APL mode. APL characters and functions are available.

Note: To exit APL mode on a typewriter keyboard, press the PF8 key while holding down either Alt key.

Shift Selection

Numeric

NUM

Only numeric characters can be entered from the keyboard.

The numeric lock function is enabled on the active screen, the keyboard is in lowercase shift, and you are in an unprotected numeric field. The only keystrokes accepted are:

- 0 through 9
- Decimal sign (.)
- Minus sign (-)
- Dup

Note: In some countries, the symbol , replaces the symbol . as the decimal sign.

To override the numeric lock function, use any shift key.

Upshift

↑

Your keyboard is in the uppercase shift condition.

Alpha characters entered from the keyboard will appear in uppercase. If you press a key with two characters or symbols on its face, the symbol in the top part of the key is displayed.

Highlight Selection

Normal (Field Inherit)

a ▶

You can select any character highlighting for the current field.

The application program defined no highlighting for the current field, but you can choose character highlighting. While you see this indicator, all characters entered will have no highlighting.

Blink (Field Inherit)

⦿ ▶

Blink character highlighting is specified, but you can select other character highlighting.

The application program defined blink highlighting for the current field, but you can choose another form of highlighting. While you see this indicator, any character entered has blink highlighting.

Reverse Video (Field Inherit)



Reverse video character highlighting is specified, but you can select other character highlighting.

The application program defined reverse video highlighting for the current field, but you can choose another form of highlighting. While you see this indicator, any character entered has reverse video highlighting.

Underscore (Field Inherit)



Underscore character highlighting is specified, but you can select other character highlighting.

The application program defined underscore highlighting for the current field, but you can choose another form of highlighting. While you see this indicator, any character entered has underscore highlighting.

Blink (Operator-Selected)



You have selected blink character highlighting.

You selected blink character highlighting for the current field by pressing the Blink key. When you see this indicator, any character entered will have blink highlighting.

Reverse Video (Operator-Selected)



You have selected reverse-video character highlighting.

You selected reverse-video character highlighting for the current field by pressing the Reverse Video key. When you see this indicator, any character entered will have reverse-video highlighting.

Underscore (Operator-Selected)



You have selected underscore character highlighting.

You selected underscore character highlighting for the current field by pressing the Underscore key. When you see this indicator, any character entered will have underscore highlighting.

Insert

Insert Mode



The active screen is in insert mode.

This indicator appears when you place the active screen in insert mode by pressing the Insert () key. (For a description of insert mode, refer to “Insert Mode Key” in Chapter 6.) You turn off insert mode either by pressing Reset or by performing any action that sends data to the host processor, such as pressing Enter or Clear.

Printer Status

Assign Printer



You can assign a printer.

You have pressed Ident and can now assign a printer by keying in the printer ID in place of -- .

Printer Assignment



Your printer ID is nn .

Your 3290 is authorized to use the printer with ID nn .

Printer Failure



Your printer stopped.

The printer with ID nn stopped while printing data from your 3290. Press DvCnl to remove this indicator.

Printer Printing



Your printer is printing.

The printer with ID nn is printing data from your 3290.

What Printer



Your printer ID changed.

Someone changed your printer ID. Press Ident to display the new printer ID.

Image Limit

Image Limit



You have exceeded the number of PELs that can be displayed on the screen at any one time.

For more information about this indicator, refer to “Image Limit” in Chapter 3.

Logical-Terminal ID

Logical-Terminal ID

nnnn

nnnn is the ID of the active logical terminal.

During normal operation, nnnn reflects the ID of the active logical terminal. The default IDs are LT-1, LT-2, LT-3, and LT-4, but these can be changed in setup mode. For more information, refer to “Logical-Terminal Definition Table” in Chapter 3.

Row and Column Position

Row and Column Indicator

Indicates the position of the cursor on the screen.

During normal operation, this indicator displays the cursor position in the decimal form:

nnnn/ccc

nnnn represents the horizontal row, and ccc represents the vertical column relative to the upper left corner (0001/001) of the active screen or partition.

Each time the cursor moves, the indicator is updated to reflect the current cursor position. You cannot suppress its display. This indicator is not displayed in setup mode or copy screen mode.

Chapter 6. 3290 Keyboard and Keypad

This chapter describes how each key operates normally. For a description of how they operate in setup mode and in copy screen mode, refer to Chapter 3.

Your IBM 3290 keyboard, available in a typewriter or APL design layout, consists of:

- 104 keys for most countries
- 105 keys for Japanese/English usage
- 106 keys for Japanese/Katakana usage.

You can expand your keyboard functions by adding either of the following:

- 24-key calculator keypad (25 keys for some countries)
- 25-key program function keypad.

Keyboard

Figure 6-1 shows the 104-key typewriter keyboard layout; Figure 6-2, the 104-key APL keyboard layout. The keyboard consists of:

- 10 left control keys
- 11 right control keys
- 24 program functions keys (above the data keys)
- 49 data keys and 10 control keys.

The 3290 keyboards are functionally similar to present 3270 system keyboards. The following keys are unique to 3290:

- Clear Partition
- Jump Partition
- Jump Screen
- Set Up
- Zoom
- Rule
- Scroll Forward
- Scroll Backward
- Change Screen.

The data key keytops are pearl white with black molded characters. The program function keys are pebble gray with black characters. The APL-specific characters are orange. Some of the keys have a function printed on their front faces. These are *alternate functions*. To perform the alternate function on such a key, press the desired alternate function key while holding down either alternate Shift key. In addition, most keys are *typematic*, or repeat-action, keys; this means that the function is repeated as long as the key is held down.

When you hold down either \uparrow key, and you press an alphabetic key, the uppercase character is displayed. If you are not in uppercase shift and an alphabetic key is pressed, the lowercase character is displayed. If your 3290 is in monospace mode, however, only uppercase alphabetic characters are displayed, but the program still recognizes the difference between alphabetic characters entered in uppercase and in lowercase.

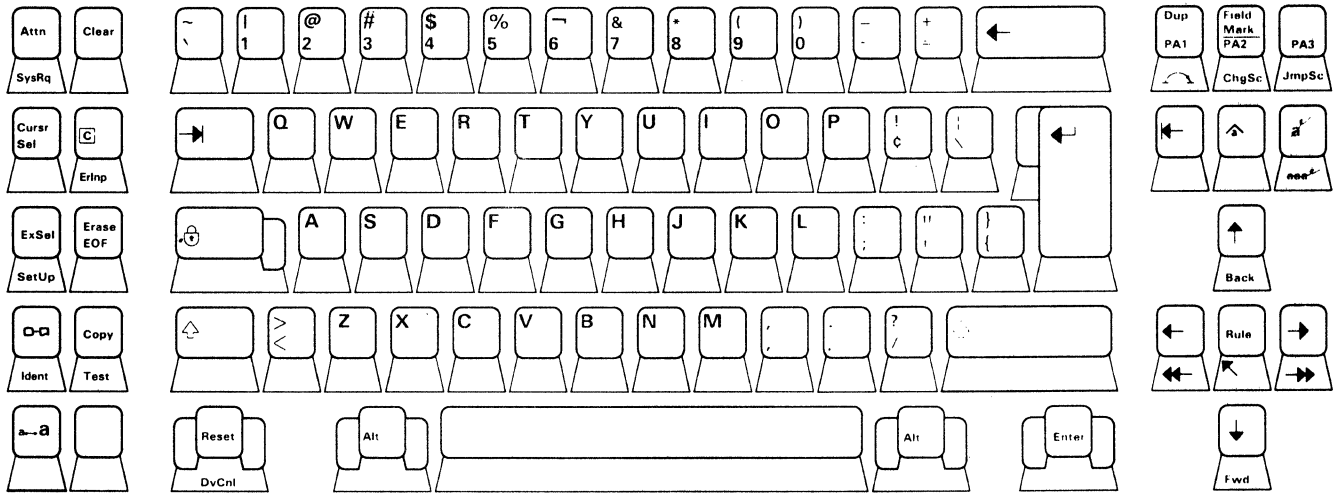
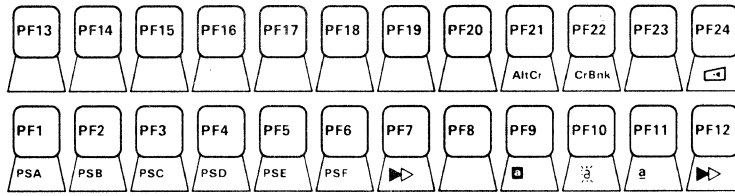

Figure 6-1. 104-Key Typewriter Keyboard Layout

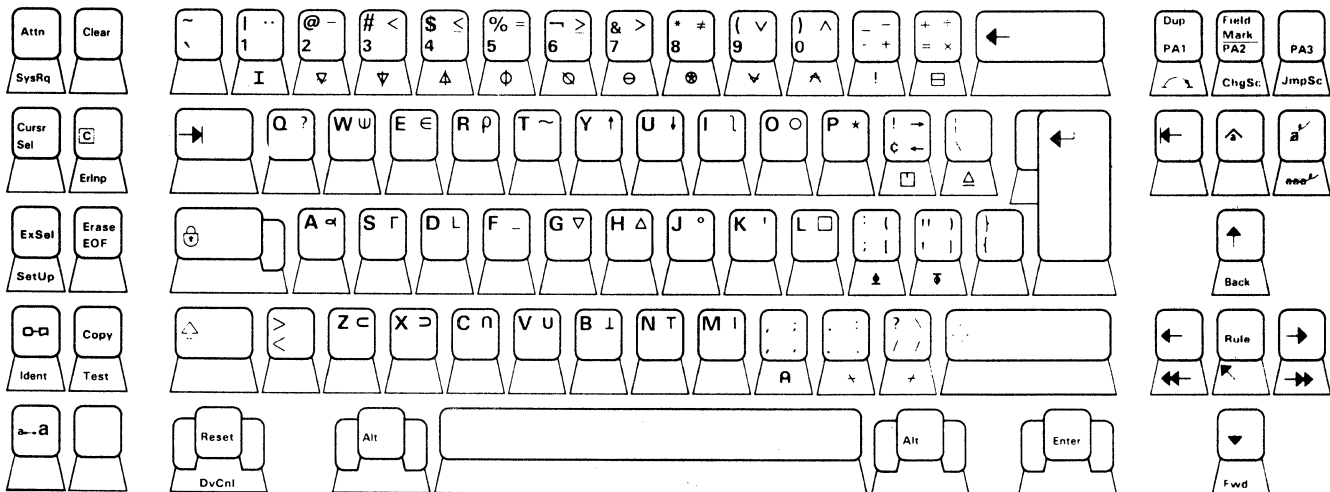
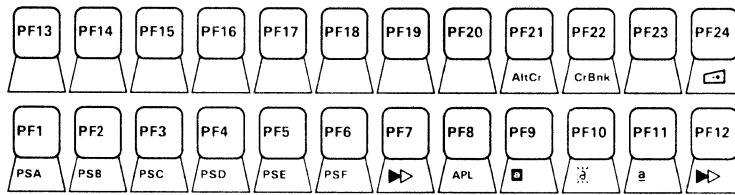

Figure 6-2. APL Keyboard Layout

Note: Though not engraved on the keytops, the APL characters are available on a typewriter keyboard. For example, to enter APL mode, press PF8 while holding down either Alt key.

Your keyboard adjusts to three positions for typing comfort. There are two adjustable legs under the keyboard. To adjust the angle of your keyboard, press the pushbutton on each side of the keyboard, releasing the legs. Select the angle you desire, and release the pushbuttons. The legs will lock in that position.

Your keyboard contains a clicker that causes a clicking sound when you press a key. You can adjust the volume of the clicker by using the Clicker Volume Control on the underside of the keyboard. You can also turn the clicker on or off as described under "Clicker Key," later in this chapter.

- If the clicker is on, the *absence* of the clicking sound indicates that your keyboard is locked as a result of a do-not-enter condition and an ✕ indicator appears.
- If the clicker is off, the *presence* of the clicking sound indicates that your keyboard is locked as a result of a do-not-enter condition and an ✕ indicator appears.

The following keys do not click when pressed:

- Uppercase Shift
- Shift Lock
- Reset
- DvCnl
- Alt
- Enter.

A 36-inch cable connects the keyboard to the logic element. You may order other cable lengths as accessories.

Keyboard Controls

Clicker Volume Control

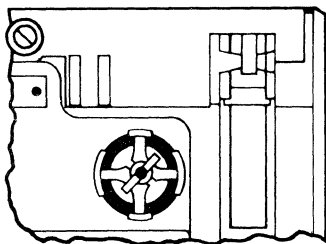

Adjusts the volume of the keyboard clicker.

This control, located on the underside of the keyboard, adjusts the volume of the keyboard clicker. Turning it clockwise (↻) increases the volume of the keyboard clicker. Turning it counterclockwise (↺) decreases the volume of the keyboard clicker.

Keyboard ID Switches

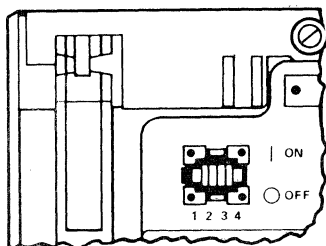

These switches perform no function.

Keypad

Each keypad adjusts to three positions for typing comfort. The adjustable legs are located under the keypad. Pull down the leg that gives you the desired angle.

A 30-inch cable connects the keypad to the center back of the typewriter keyboard. Thus, you can move the keypad to either side of the keyboard.

The keys on your keypad make a clicking sound when you press them. The clicker controls (Volume and On/Off) are the same controls as for the keyboard and are located on the keyboard. All the keys perform the same function as their respective keys on the keyboard.

The keypad program function layout and the calculator layout are shown in Figure 6-3 and 6-4, respectively.

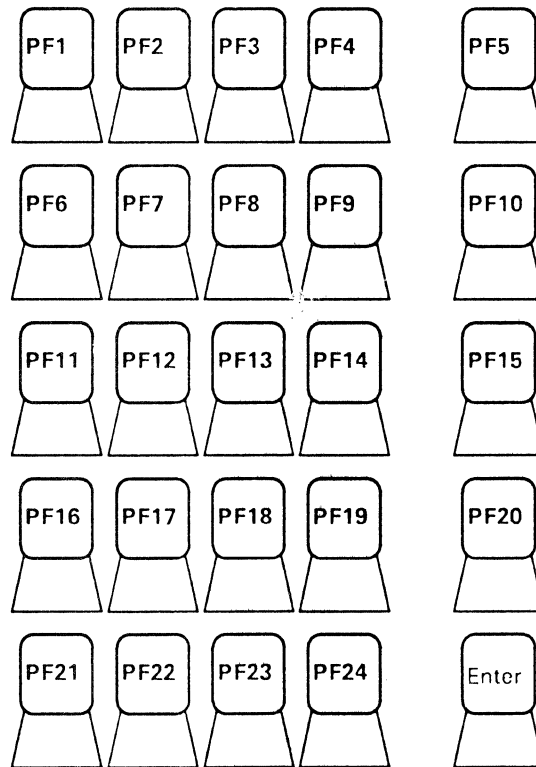
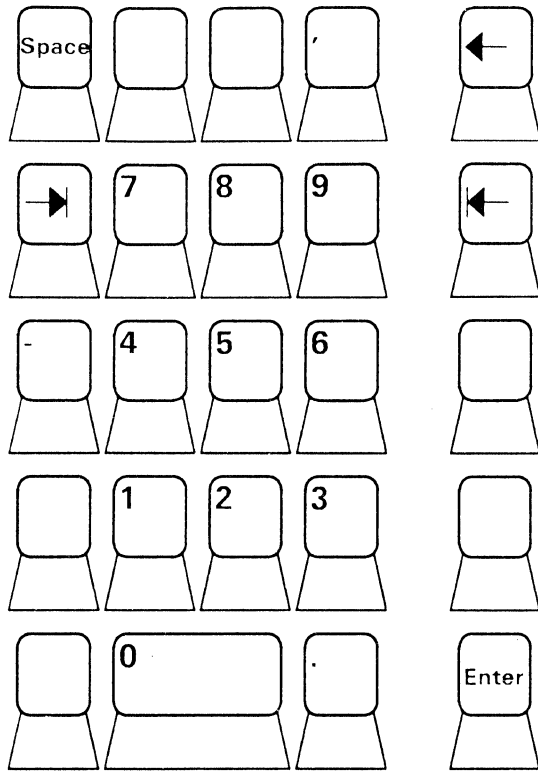
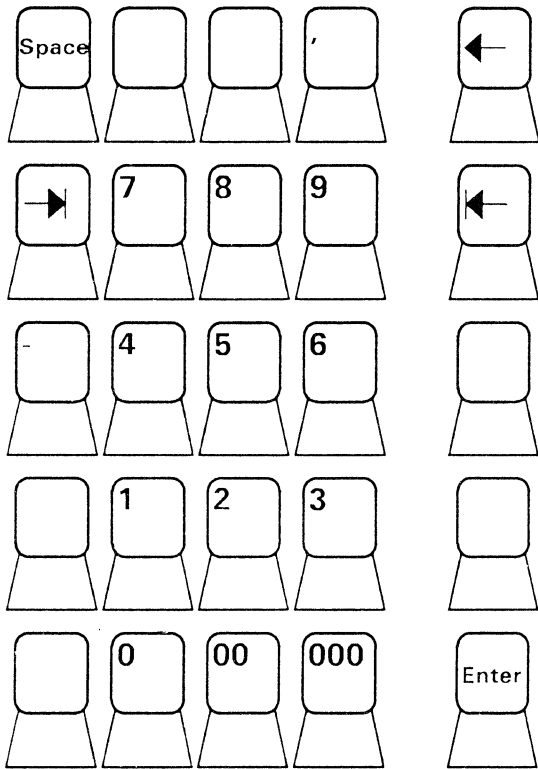

Figure 6-3. 3290 Keypad - Program Function Layout



U.S. and Canada



World Trade Countries

Figure 6-4. 3290 Keypad - Calculator Layout

Keyboard Key Functions

For easy use, this chapter groups keys into four sections, according to their physical location:

- Left control keys
- Right control keys
- Program function keys
- Data keys.

Left Control Keys

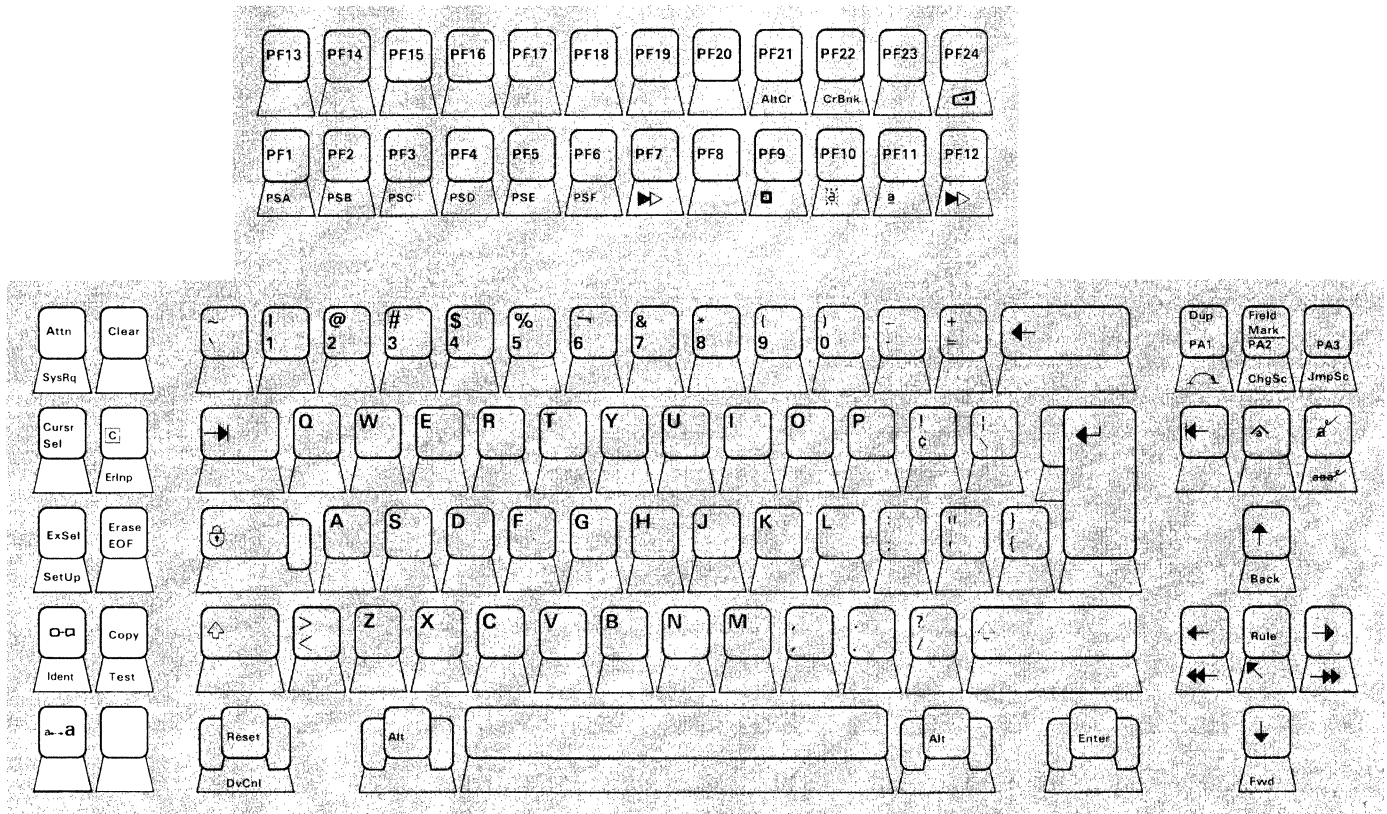

Attention Key

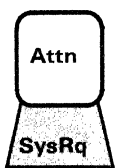

Signals the application program.

Use this key to get the attention of the application program.

Attn is operative only when $\boxed{4}^B$ is displayed in the operator information area. In addition, certain systems network architecture (SNA) states must be correctly set. If you press Attn when $\boxed{4}^B$ is not displayed, $\times -f$ appears in the operator information area.

The application program defines how the Attention key is used.

Clear Key

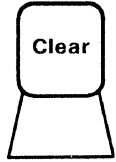

Erases the active screen and moves the cursor to row 1/column 1.

When you press Clear, you:

- Erase every character position on the active screen
- Destroy any partitions
- Establish an unformatted screen
- Move the cursor to row 1/column 1 on the screen if the cursor is not already there
- Establish a *default* screen size.

In addition, when you press Clear with ■ displayed, the application program is signaled, ✕ appears, your keyboard is locked, and one of the following occurs:

- ✕ remains, and the keyboard remains locked if the application program does not reply.
- ✕ disappears, and the keyboard unlocks if the application program accepts the signal.
- ✕ SYSTEM appears, and the keyboard remains locked if the application program rejects the signal. Press Reset to remove this indicator and to unlock the keyboard.

Clear Partition Key

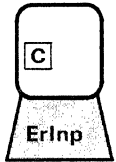

Erases the active partition and moves the cursor to the upper-left corner of that partition.

When you press □ with ■ displayed, you:

- Erase every character location in the active partition
- Redefine the partition as an unformatted partition
- Move the cursor to row 1/column 1 of the partition
- Can cause autoscrolling
- Signal the application program.

If either your screen is not partitioned or ■ does not appear (in an SNA environment) and you press □, ✕ - f appears. Press Reset to remove this indicator and to unlock the keyboard.

If you have only one partition and you press □ ✕ appears; if you have multiple partitions and you press □, ✕ ← → appears. In either case, your keyboard locks and one of the following occurs:

- ✕ or ✕ ← → remains, and the keyboard remains locked if the application program does not reply.
- ✕ or ✕ ← → disappears, and the keyboard unlocks if the application program accepts the signal.
- ✕ SYSTEM appears, and the keyboard locks if the application program rejects the signal. Press Reset to remove this indicator and to unlock the keyboard.

Copy Key

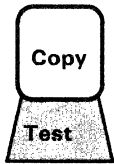

This key performs no function.

Cursor Select Key

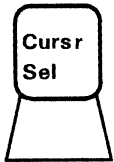

Selects fields defined as selectable.

You can perform selection and attention operations with the cursor. There are two types of selectable fields: (1) selection fields and (2) attention fields. Use CursrSel either to select items in selection fields or to notify the program of your selection by selecting an attention field.

The first character of each selectable field is a designator character. The designator character for a selection field is either a question mark (?) or a greater-than sign (>). The designator character for an attention field is either an ampersand character (&) or a blank position.

Initially, the designator characters in most of the selection fields on your screen are probably question marks. To select a field, position the cursor within the field that you want to select and press CursrSel. '?' at the beginning of the selected field changes to '>' to indicate that you have selected the field.

If you select an incorrect field, you can correct your mistake by selecting the field again with CursrSel. This action changes '>' back to '?'.

After you have completed your selections, locate a field that has an ampersand or a blank position as a designator character. Selecting the attention field displays either \times or $\times \leftarrow \rightarrow$ and signals the program that you have completed your selections.

If you press CursrSel in a field not defined as selectable, $\times \leftarrow \rightarrow$ appears. Press Reset to remove this indicator and to unlock the keyboard.

Erase to End of Field Key



Erases data from the cursor position to the end of the field, but does not move the cursor.

When you press Erase EOF, and the cursor is in an unprotected field, you erase all characters from the cursor to the end of the field. The cursor, however, does not move. If the active screen or partition is unformatted, you erase all characters from the cursor to the last character on the bottom line.

Pressing Erase EOF when the cursor is within a protected field or at an attribute location displays $\times \leftarrow \rightarrow$. Press Reset to remove this indicator and to unlock the keyboard.

Erase Input Key

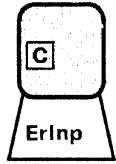

Erases the contents of all unprotected fields and moves the cursor to the first unprotected field.

When you press ErInp while holding down either Alt key, you erase the contents of all unprotected fields in the active screen or partition and move the cursor to the beginning of the first unprotected field.

If the active screen or partition is unformatted, ErInp erases all characters and moves the cursor to row 1/column 1 of the screen or partition.

If the active screen or partition contains only protected fields, the cursor moves to row 1/column 1 of the screen or partition and no data is erased.

In a scrollable partition, if row 1/column 1 is outside the viewport, autoscrolling will occur.

ExSel Key

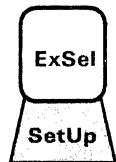

This key performs no function.

Ident Key

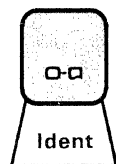

Changes the printer ID or displays the existing printer ID.

When you press Ident while holding down either Alt key, you either (1) request a change to your printer ID/printer class or (2) cause the existing printer ID to appear. The printer status indicator displayed in the operator information area determines which action occurs.

You may specify printers by printer IDs or by printer classes. A printer ID number is the address assigned to a printer by the control unit. Printer ID numbers are 01 through 31.

Your organization may separate the printers connected to your control unit into printer classes. Printer class numbers are 70 through 85. A printer class may be grouped by (1) physical characteristics (speed, character set, type of forms used, etc.), (2) physical location, (3) security, or (4) operators who are authorized to use it. For example, printer class 85 may specify all printers capable of printing both uppercase and lowercase characters.

If □-□nn appears in the operator information area, it is replaced by □-□__ when you press IDENT. You can now change your printer ID/printer class by entering the new 2-character printer ID or printer class number. Your printer ID or printer class number appears in the two underlined locations of □-□__ . If you do not want to change the printer ID or printer class, press Reset.

✘ 𐀀#? appears if you enter an invalid printer ID or printer class number. Press Reset and try the IDENT key operation again, using a correct printer ID or printer class number.

✕ 𐀀✕ appears if you enter a printer ID or printer class for which you are not authorized. Press Reset and try the IDENT key operation again, using a printer ID or printer class for which you are authorized.

□-□?? appears if someone changed your printer authorization. In this case, pressing IDENT causes □-□nn to replace □-□??. This specifies your new printer assignment.

If □-■nn is displayed and you press IDENT, ✕ -f appears. Press Reset to remove this indicator and to unlock the keyboard.

If no printer status indicator is present and you press IDENT, ✕ 𐀀✕ appears. Press Reset to remove this indicator and to unlock the keyboard.

Print Key

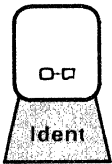

Causes your 3290 to enter copy screen mode.

When you press □-□, your 3290 enters copy screen mode, □-? appears in the operator information area, and the rest of the operator information area is rewritten. You must now select either a printer operation or a copy screen operation.

Print Operation

To print the active screen or partition, position the cursor under the □-□ indicator and press CursrSel. Copy screen mode is exited, the operator information area is rewritten, and the print operation is initiated. The printer that is available is specified by □-□nn, where nn is the printer ID/printer class.

If no printer status indicator is displayed, or if the printer status indicator is □-□?? or □-□nn, and nn identifies a printer that is actually a display, or does not support SCS, ✕ 𐀀✕ appears. Press Reset to remove this indicator and to unlock the keyboard.

If the printer status indicator is □-□nr, and nn identifies a valid printer, the printer identified by nn is used to initiate the print request.







If the printer is busy, one of the following Do Not Enter indicators appears in the operator information area:

- ✕ □-□⊙ The printer is busy and cannot perform your print operation.
- ✕ □-□⊙⊙ The printer is very busy, and more time than usual is expected before your print request is accepted.



At this point, you can either (1) wait for the print operation to be completed or (2) press DvCnl to cancel the print operation and to restore your keyboard.

Note: The DvCnl key can cancel the printing only of data that has not yet been sent to the printer. For this reason, some or all of your data may be printed even if you press DvCnl.

If the printer is not working,  appears in the operator information area. This means the printer cannot perform your print operation and your print request has been canceled. Press DvCnl to restore your keyboard. You may then either (1) select a different printer or (2) try to restore the failing printer.

When your print operation starts,  replaces  in the printer status area, and  appears in the operator information area. When your print operation is completed,  replaces . If you press DvCnl while  is displayed, the remainder of your print operation is canceled,  is removed, and your keyboard is unlocked.



If the printer fails while printing your print request:

1.  changes to .
2.  appears.
3. Your keyboard is disabled.
4. Your print request is canceled.

Press DvCnl to remove both indicators and to restore your keyboard.

Copy Screen Operation

When you press , the right side of the operator information area displays a group of symbols that represent your screen configuration.

 appears for each logical terminal, and  appears for each copy screen. These symbols appear from left to right in the operator information area and represent the screens, starting at the upper left and going clockwise.

To copy the active screen to a copy screen, position the cursor under the  corresponding to the copy screen to which you want to copy, and press CursrSel.

To clear a copy screen, position the cursor under the  corresponding to the copy screen you want to clear, and press Clear. For more information about copy screen operations, refer to "Multiple Copy Screen Function" in Chapter 3.

Setup Key

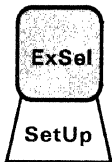

Allows you to select a different panel configuration.

When you press SetUp while holding down either Alt key, the 3290 enters setup mode. The cursor moves from the active screen to the operator information area to allow you to tailor the information panel to your unique work environment.

Press SetUp again to exit setup mode and return the cursor to its original location on the active screen. For more information, refer to "Setup Functions" in Chapter 3.

System Request Key

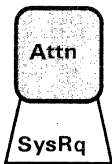

Changes the screen ownership in an SNA environment; transmits a test request in a non-SNA environment.

Operating in an SNA Environment

Pressing SysRq while holding down either Alt key switches ownership of the active screen between the application program (■) or an unowned logical terminal (□) and the System Services Control Point (SSCP) (⊠).

When ⊠■ or ⊠□ appears, pressing SysRq:

- Destroys any partitions
- Erases the active screen
- Establishes a default screen size
- Moves the cursor to row 1/column 1 on the screen
- Replaces ■ or □ with ⊠
- Cancels APL mode
- Cancels any programmed symbol set or highlight selections.

Successive pressing of SysRq causes screen ownership to alternate between ⊠ and ■ or □.

Operating in a Non-SNA Environment

Pressing SysRq sends a signal to the host initiating a test request if you are in implicit partition state. In explicit partitioned state, ✕ -f appears.

Note: In either an SNA or a non-SNA environment, pressing SysRq when neither ⊠, ■, nor □ appears causes ✕ -f to appear. Press Reset to remove this indicator and to unlock the keyboard.

Test Key

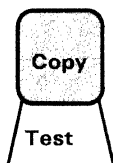

Places the 3290 in test mode to run subsystem tests.

When you press Test while holding down either Alt key, the 3290:

- Erases every character on the panel
- Displays TEST in the operator information area and enters Test mode
- Displays ✕ ⊠ for a brief period in the operator information area
- Unlocks the keyboard
- Positions the cursor to row 1/column 1
- Destroys all partitions
- Destroys all host sessions.

Press Test again to exit Test mode.

Warning: Pressing Test may result in a loss of data.

Zoom Key

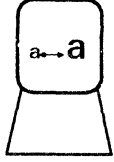

Enlarges selected portions of data on the screen.

Pressing this key places the 3290 in zoom mode. Pressing it again causes it to exit zoom mode.

In zoom mode, only the active logical screen or active partition (or its viewport) is displayed. The data is presented in the largest allowable character size with optimum spacing between characters. For more information about zoom mode, refer to "Zoom Function" in Chapter 3.

Right Control Keys

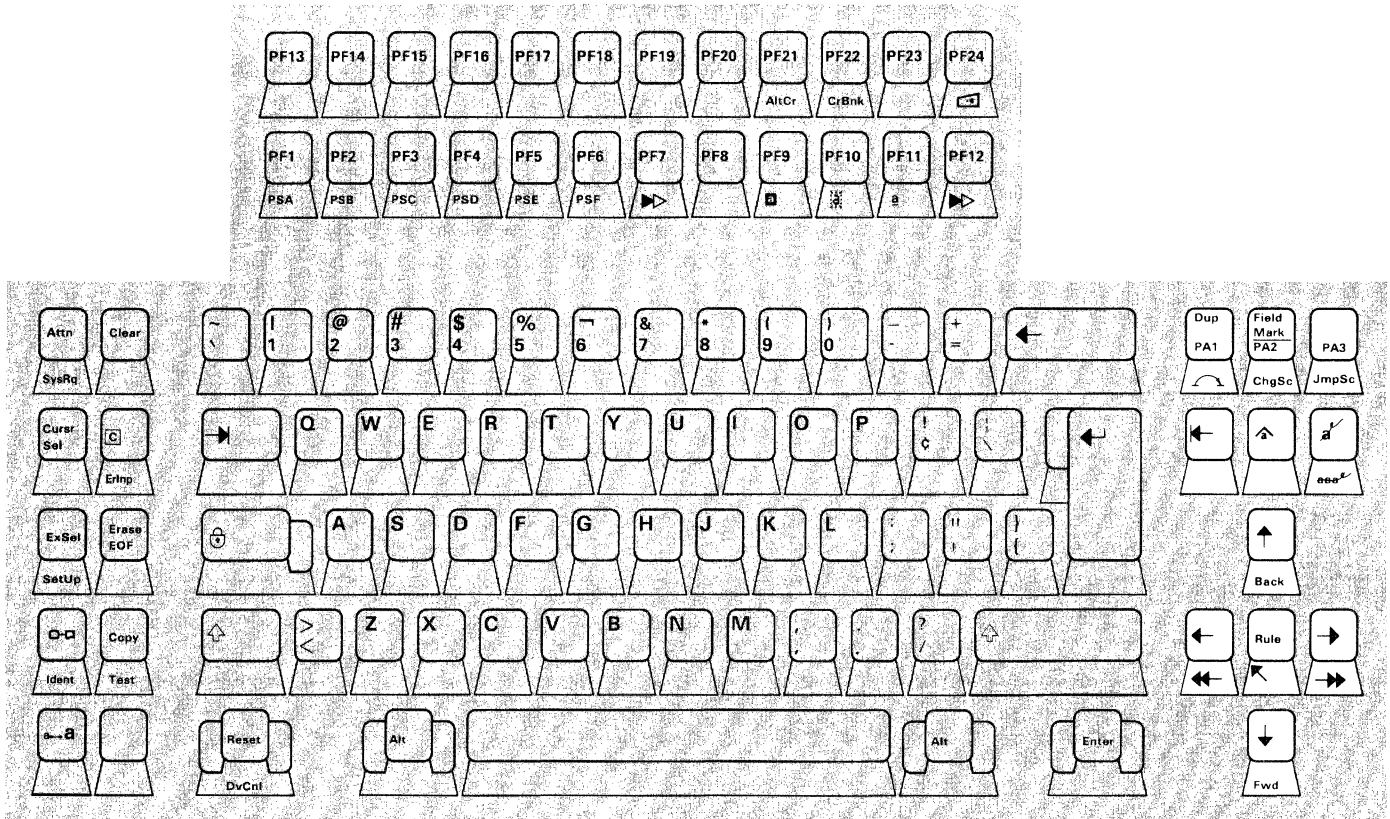

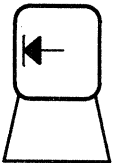

Backtab Key



Moves the cursor back to the first position of an unprotected field.

If the cursor is in an unprotected field but is not at the first character position in that field, press  to move the cursor back to the first character position in the field.

If the cursor is in a protected field, in an attribute position, or in the first character position of an unprotected field, and you press , the cursor moves to the first character position of the *preceding* unprotected field.

If the partition is not formatted, contains only protected fields, or contains only attributes, pressing  moves the cursor to row 1/column 1 of the active screen or partition. In a scrollable partition, pressing  can cause autoscrolling.

Backtab is a typematic key.

Change Screen Key



Moves screens between the panel and the background queue.

Pressing ChgSc while holding down either Alt key causes the logical screen at the top of the background queue to become the active screen. The previously active screen is placed at the bottom of the background queue and is no longer displayed.

For more information, refer to “Multiple Interactive Screens Function” in Chapter 3.

Cursor Left and Cursor Right Keys

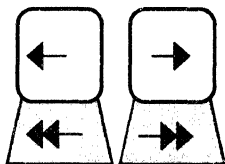

Moves the cursor in the direction of the arrow.

These keys move the cursor to any position on the screen, whether protected, unprotected, or attribute. Press either of these keys to move the cursor in the direction of the arrow, one position at a time. If you hold down \rightarrow and the cursor moves off the right side of the viewport, it reappears one line lower on the left side; that is, the cursor *wraps*. The cursor also wraps when you hold down \leftarrow . It reappears one line higher on the right side of the viewport. These keys do not cause autoscrolling.

The Cursor Left (\leftarrow) and Cursor Right (\rightarrow) keys are typematic.

Cursor Up and Cursor Down Keys

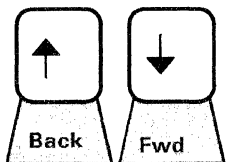

Moves the cursor in the direction of the arrow.

These keys move the cursor to any position on the screen, whether protected, unprotected, or attribute. Press either of these keys to move the cursor in the direction of the arrow, one line at a time. If either key is held down and the cursor moves off the edge of the viewport, it reappears in the same column, on the opposite edge of the viewport. These keys do not cause autoscrolling. The Cursor Up (\uparrow) and Cursor Down (\downarrow) keys are typematic.

Delete Character Key

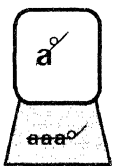

Deletes the character at the present cursor position.

Press $\overset{\circ}{a}$, when the cursor is in an unprotected field or in an unformatted screen or partition, to delete the character at the current cursor position. All characters in the field to the right of the cursor, and on the same line, are then shifted left one position, and a null character is inserted after the last character in that field. The cursor does not move.

If you press the Delete Character $\overset{\circ}{a}$ when the cursor is located in a protected field, $\times \leftarrow \overset{\circ}{a} \rightarrow$ appears. Press Reset to remove this indicator and to unlock the keyboard.

aaa Key

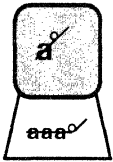

This key performs no function.

Dup Key

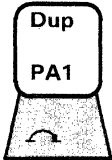

Informs the host that the rest of the field should be duplicated.

When you press Dup, with the keyboard in uppercase shift and the cursor in an unprotected field or in an unformatted screen or partition, the following occur:

- \bar{a} appears if the 3290 is in dual-case mode or if the extended attributes are enabled.
- * appears if the 3290 is in monospace mode and the extended attributes are not enabled.
- The cursor moves to the first position of the next unprotected field if the screen or partition is formatted, or to row 1/column 1 if the screen or partition is unformatted.

The Dup character (\bar{a} or *) informs the application program that a duplicate operation is required.

In a scrollable partition, if the next unprotected field is outside the viewport, Dup will cause autoscrolling.

If the cursor is in a protected field or at an attribute location when you press Dup, $\times \rightarrow \leftarrow$ appears. Press Reset to remove this indicator and to unlock the keyboard.

Field Mark Key



Informs the host of end-of-field on unformatted fields.

Use this key to inform the host of an 'end-of-field' condition. When you press Field Mark, with the keyboard in an uppercase shift condition and the cursor in an unprotected field or in an unformatted screen or partition, one of the following occurs:

- $\bar{;}$ appears if the 3290 is in dual-case mode or if the extended attributes are enabled.
- ; appears if the 3290 is in monospace mode and the extended attributes are not enabled.

If the cursor is not at the last position of an unprotected field, it moves to the next position in that field.

If the cursor is at the last position of an unprotected field, and the next field is either (1) alphanumeric or (2) numeric and unprotected, the cursor moves to the first character location of the next field.

If the cursor is at the last position of an unprotected field, and the next field is numeric and protected, the cursor moves to the first character location of the next unprotected field.

If the cursor is in a protected field or at an attribute location when you press Field Mark, **X** ←↔→ appears. Press Reset to remove this indicator and to unlock the keyboard.

Home Key

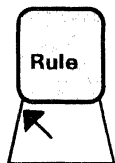

Moves the cursor to the first position of the active screen or partition.

When you press Home while holding down either Alt key, the cursor moves to the first unprotected character position of the active screen or partition.

The cursor moves to row 1/column 1 if any of the following conditions exists:

- The screen or partition is unformatted.
- There are no unprotected fields.
- There are attributes only.

In a scrollable partition, this key can cause autoscrolling.

Insert Mode Key

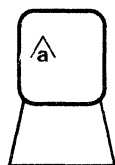

Allows characters to be inserted in a field.

Press **^** to place the keyboard in insert mode. The Insert indicator (**^**) appears in the operator information area. Provided there is at least one null character between the cursor and the end of the field, entering a data character into an unprotected field causes the following actions:

- The character at the current cursor position and all subsequent characters up to, but not including, the first null character move one position to the right.
- The keyed character is displayed at the cursor position.
- The cursor is advanced to the next character position.

In a scrollable partition, if the new character entered is in the last character position of the viewport, autoscrolling occurs as the cursor moves to the next line.

If the field contains no null characters, an attempt to insert a character causes **X** ↗ to appear. Press Reset to remove this indicator and to unlock the keyboard. To turn off insert mode, press Reset.

Pressing the following keys also turns off insert mode:

- Clear
- SetUp
- Test
- Enter
- SysRq
- Clear Partition
- PA1, PA2, PA3
- PF1 – PF24.

Jump Partition Key

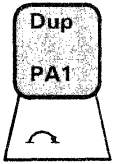

Moves the cursor to a new partition.

When you press \curvearrowright while holding down either Alt key, the cursor jumps from the active partition to the next sequential partition as defined by the application program. This new partition now becomes the active partition. The cursor is positioned within the new partition either at (1) the last cursor location when this partition was previously active or at (2) a new cursor location set up by data stream commands while the partition was inactive. If you have only one partition, \curvearrowright has no effect.

To use \curvearrowright , you must remove all *Do Not Enter* indicators except $\times \curvearrowright$ or \times SYSTEM. Press Reset to remove all indicators except $\times \curvearrowright$ and to unlock the keyboard.

Jump Screen Key

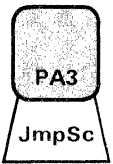

Moves the cursor to the next logical screen.

When you press JmpSc while holding down either Alt key, the cursor jumps to the current cursor position of the next displayed logical screen, moving in a clockwise direction. This key is effective only if you have multiple screens.

Program Access (PA) Keys – PA1 through PA3

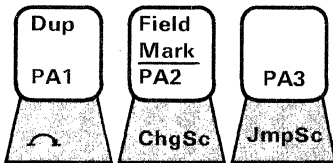

These keys communicate with the application program.

The program access keys provide a means of signaling or communicating with the application program. The application program defines their use.

If you have only one partition, and you press a program access key, $\times \curvearrowright$ appears; if you have multiple partitions and you press a program access key, $\times \curvearrowright$ appears. In either case, your keyboard locks and one of the following occurs:

- $\times \curvearrowright$ or $\times \curvearrowright$ remains, and the keyboard remains locked, if the application program does not reply.
- $\times \curvearrowright$ or $\times \curvearrowright$ disappears, and the keyboard unlocks if the application program accepts the signal.
- \times SYSTEM appears, and the keyboard remains locked, if the application program rejects the signal. Press Reset to remove this indicator and to unlock the keyboard.

In an SNA environment, pressing a PA key when ■ is not displayed causes \times -f to appear. Press Reset to remove this indicator and to unlock the keyboard.

Pressing a PA key while a previous inbound transmission is being processed causes $\times 7+$ to appear. Press Reset to remove this indicator and to unlock the keyboard.

Rule Key

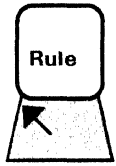

Displays a line under a single row of characters.

Pressing Rule places a horizontal line under the row containing the cursor in the active logical screen or partition.

The rule line helps you identify and relate widely separated data located in the same row on the display screen. Press Rule again to erase the rule line.

For more information about the Rule key, refer to “Rule Function” in Chapter 3.

Scroll Forward and Backward Keys

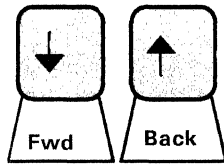

Moves data forward or backward on the screen.

Pressing either Fwd or Back while holding down either Alt key causes data in a scrollable partition to move up or down in the viewport. This action enables you to see data in the partition that is not currently in view. The cursor remains in the viewport.

The Fwd and Back keys have no effect if any of the following conditions exists:

- You are in a nonscrollable partition.
- You have an unpartitioned screen.
- You are at the top line of a partition (Back key only).
- You are at the bottom line of a partition (Fwd key only).

The scroll keys are typematic keys.

←→ Keys

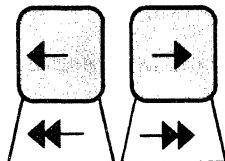

These keys perform no function.

Program Function Keys

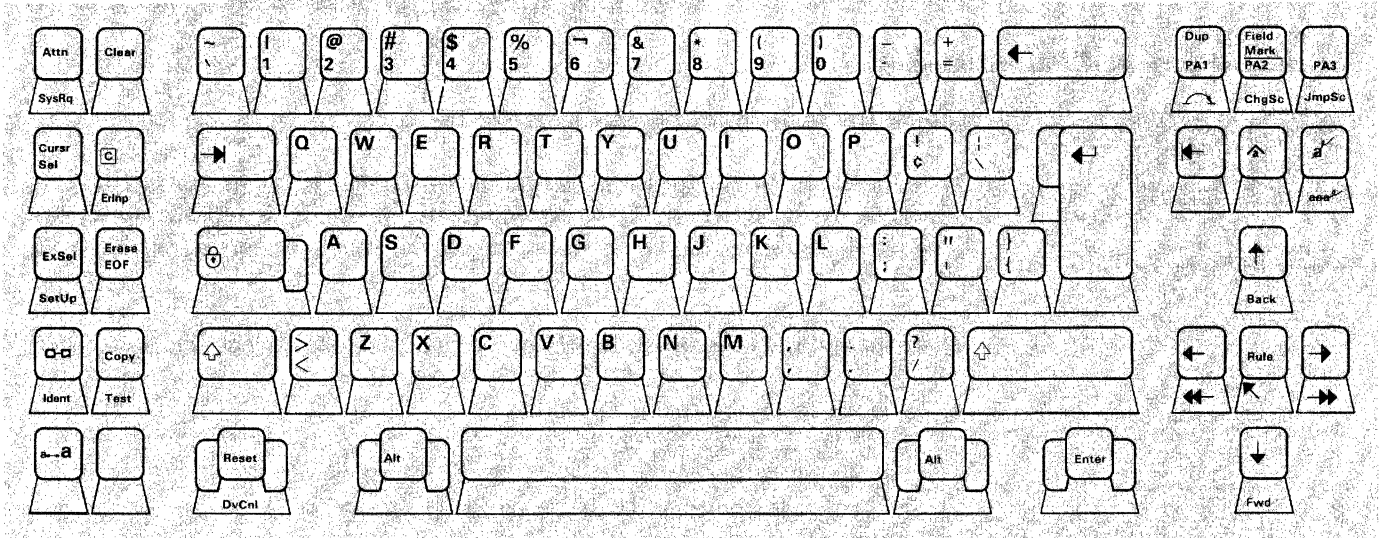
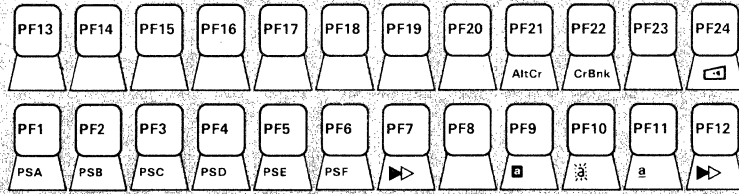

Alternate Cursor Key

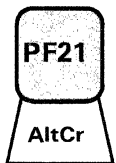

Selects between underscore and reverse video cursor image.

Pressing AltCr while holding down either Alt key changes the form of the cursor:

- If your cursor is an underscore (_), pressing AltCr replaces it with reverse video (█).
- If your cursor is reverse video, pressing AltCr replaces it with an underscore.

APL Key

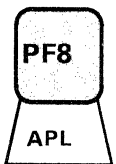



Changes the keyboard between APL and typewriter modes.

Pressing APL while holding down either Alt key does the following:

- If your keyboard is in typewriter mode, pressing APL places it in APL mode and APL appears in the operator information area. APL characters can now be entered from the keyboard.
- If your keyboard is in APL mode, pressing APL places it in typewriter mode and erases APL. APL characters can no longer be entered from the keyboard.



APL characters that are displayed on the screen are not affected by this key.

If you press this key when  is displayed,  -f appears. Press Reset to remove this indicator and to unlock the keyboard.

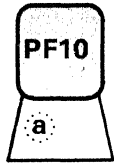
Blink Character (Highlighting) Key



Causes entered characters to blink.

If highlighting is in use, and the application program allows you to change the highlighting, pressing  while holding down either Alt key causes entered characters to blink and  to appear in the operator information area. Blink highlighting remains in effect until one of the following occurs:

- You select a different highlighting.
- The application program selects a different highlighting and no longer allows your selection.
- You press *JumpSc*, *ChgSc*, or . The highlighting selected for the new logical terminal or partition takes effect. If you return to the original logical terminal or partition, blink highlighting becomes effective again.

If the active logical terminal does not have extended attributes enabled, the Blink Character key is ignored.

The application program allows you to change the highlighting only when one of the following combinations of indicators appears:



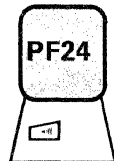

If none of these is displayed, pressing this key causes  to appear. Press *Reset* to remove this indicator and to unlock the keyboard.

Clicker Key



Turns the keyboard clicker on or off.

Your keyboard has a clicker that causes a click when you press the keys. If you press  while holding down either Alt key when the clicker is on, you turn the clicker off. If you press  when the clicker is off, you turn the clicker on.

Cursor Blink Key

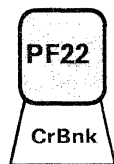

Causes the cursor either to blink or to remain on.

The cursor can be either nonblinking or blinking. If the cursor is nonblinking and you want it to blink, press *CrBnk* while holding down either Alt key. If the cursor is blinking and you want it nonblinking, press *CrBnk* while holding down either Alt key.

Field Inherit Keys

These keys cause highlighting or programmed symbol set selection to be controlled by the application.

Programmed Symbol Set Field Inherit

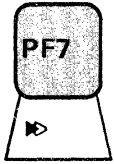

If the application program allows you to change the programmed symbol set, pressing the leftmost \blacktriangleright key while holding down either Alt key causes entered characters to be displayed from the programmed symbol set selected by the application program. One of the following indicators appears in the operator information area, identifying the symbol set selected by the application program:

PSA \blacktriangleright PSB \blacktriangleright PSC \blacktriangleright PSD \blacktriangleright PSE \blacktriangleright PSF \blacktriangleright

Before you press this key:

- The active logical terminal must be configured with the extended attributes enabled, and the programmed symbol sets must be allocated to it. If these conditions are not met, this key is ignored. For more information about configuring your logical terminal, refer to “Setup Functions” in Chapter 3.
- The application program must allow you to select a programmed symbol set. If selection of a programmed symbol set is allowed, one of the following appears:

PSA \blacktriangleright PSB \blacktriangleright PSC \blacktriangleright PSD \blacktriangleright PSE \blacktriangleright PSF \blacktriangleright

PSA † PSB † PSC † PSD † PSE † PSF †

If you press this key and the application program does not allow symbol set selection, $\times - f \dagger \times$ appears. Press Reset to remove this indicator and to unlock the keyboard.

Once you choose to have the application program control the program symbol set, it does so until one of the following occurs:

- You select a new symbol set.
- You press the \curvearrowright key, and the cursor moves to a new partition. The programmed symbol set selection for this partition takes effect. If you return to the original partition, the programmed symbol set that was previously selected for that partition becomes active again.
- You press the JmpSc or ChgSc key, and the new logical terminal does not allow programmed symbol sets. When the original logical terminal reappears, the selected programmed symbol set is once again active.

Highlighting Field Inherit

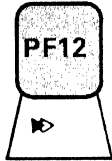

If the application program allows you to change highlighting, pressing the rightmost \blacktriangleright key while holding down either Alt key causes entered characters to appear with the character highlighting selected by the application program. One of the following indicators appears, identifying the highlighting selected:

a \blacktriangleright \odot \blacktriangleright \square \blacktriangleright a \blacktriangleright

If the active logical terminal does not have extended attributes enabled, \blacktriangleright is ignored. If extended attributes are enabled, you can change the highlighting if one of the following indicators is displayed in the operator information area:

a \uparrow \odot \uparrow \square \uparrow a \uparrow
a \blacktriangleright \odot \blacktriangleright \square \blacktriangleright a \blacktriangleright

If none of these indicators is displayed, pressing this key causes \times -f \uparrow \times to appear. Press Reset to remove this indicator and to unlock the keyboard.

Program Function (PF) Keys – PF 1 through PF 24

These keys communicate with the application program.

The program function keys provide a means of communicating with the application program. The application program defines their use. The PF keys cancel insert mode.

If you have only one partition and you press a PF key, \times \odot appears in the operator information area; if you have multiple partitions and you press a PF key, \times $\leftarrow \odot \rightarrow$ appears. In either case, the keyboard locks and one of the following occurs:

- \times \odot or \times $\leftarrow \odot \rightarrow$ remains, and the keyboard remains locked, if the application program does not reply.
- \times \odot or \times $\leftarrow \odot \rightarrow$ disappears, and the keyboard unlocks, if the application program accepts the signal.
- \times SYSTEM appears, and the keyboard remains locked, if the application program rejects the signal. Press Reset to remove this indicator and to unlock the keyboard.

If \blacksquare is not displayed, pressing a PF key causes \times -f to appear. Press Reset to remove this indicator and to unlock the keyboard.

Pressing a PF key while a previous inbound transmission is being processed causes \times ?+ to appear. Press Reset to remove this indicator and to unlock the keyboard.

Programmed Symbols (PS) Keys, PSA through PSF

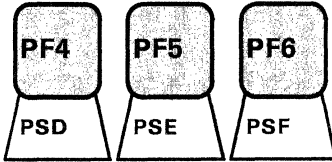
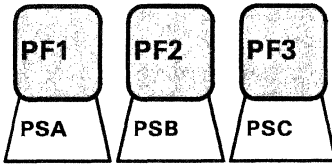

These keys allow you to select operator-selectable symbol sets.

Pressing one of these keys while holding down either Alt key selects the symbol set from which entered characters will be displayed. One of the following indicators appears, identifying the symbol set selected:

PSA † PSB † PSC † PSD † PSE † PSF †

Before you select a symbol set:

- The active logical terminal must be configured with the extended attributes enabled, and the programmed symbol sets must be allocated to it. If these conditions are not met, the Programmed Symbol keys are ignored. For more information about configuring your logical terminal, refer to “Setup Functions” in Chapter 3.
- The application program must allow you to select a programmed symbol set. If selection of a programmed symbol set is allowed, one of the following appears:

PSA † PSB † PSC † PSD † PSE † PSF †
 PSA †▶ PSB †▶ PSC †▶ PSD †▶ PSE †▶ PSF †▶

If you press a Programmed Symbol key and the application program does not allow symbol set selection, ✕ - f †✕ appears. Press Reset to remove this indicator and to unlock the keyboard.

- The programmed set you select must have been loaded by the application program and defined as operator-selectable. If this condition is not met when you press a Programmed Symbol key, ✕ - f †✕ appears. Press Reset to remove this indicator and to unlock the keyboard.



Once a programmed symbol set has been selected, it remains active until one of the following occurs:

- The application program selects a different symbol set and no longer allows operator selection.
- You select a new symbol set.
- You press the leftmost ▶ (Programmed Symbols Field Inherit) key.
- You press the ↶ key, and the cursor moves to a new partition. The programmed symbol set selection for this partition takes effect. If you return to the original partition, the programmed symbol set that was previously selected for that partition becomes active again.
- You press the JmpSc or ChgSc key, and the new logical terminal does not allow programmed symbol sets. When the original logical terminal becomes active again, the selected programmed symbol set is once again enabled.

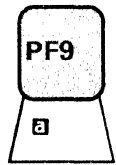
Reverse Video (Highlighting) Key



















Entered characters and their background are reversed.

If highlighting is in use and the application program allows you to change the highlighting, pressing  while holding down either Alt key causes entered characters to appear with reverse video highlighting and  to appear in the operator information area. Reverse video highlighting remains in effect until one of the following occurs:

- You select a different highlighting.
- The application program selects a different highlighting and no longer allows your selection.
- You press *JumpSc*, *ChgSc*, or . The highlighting selected for the new logical terminal or partition takes effect. If you return to the original logical terminal or partition, reverse video highlighting becomes effective again.

If the active logical terminal does not have extended attributes enabled, the Reverse Video highlighting key is ignored. If extended attributes are enabled, the application program allows you to change the highlighting only when one of the following combinations of indicators appears:



a       
a        

If none of these is displayed, pressing this key causes  - f  to appear. Press Reset to remove this indicator and to unlock the keyboard.

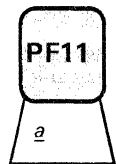
Underscore (Highlighting) Key















Entered characters are underscored.

If highlighting is in use and the application program allows you to change the highlighting, pressing  while holding down either Alt key causes entered characters to appear with underscore highlighting and  to appear in the operator information area. Underscore highlighting remains in effect until one of the following occurs:

- You select a different highlighting.
- The application program selects a different highlighting and no longer allows your selection.
- You press *JumpSc*, *Chgsc*, or . The highlighting selected for the new logical terminal or partition takes effect. If you return to the original logical terminal or partition, underscore highlighting becomes effective again.

If the active logical terminal does not have extended attributes enabled, the Underscore highlighting key is ignored. If extended attributes are enabled, the application program allows you to change the highlighting only when one of the following combinations of indicators appears:

a       
a        

If none of these is displayed, pressing this key causes  - f  to appear. Press Reset to remove this indicator and to unlock the keyboard.

Data Keys

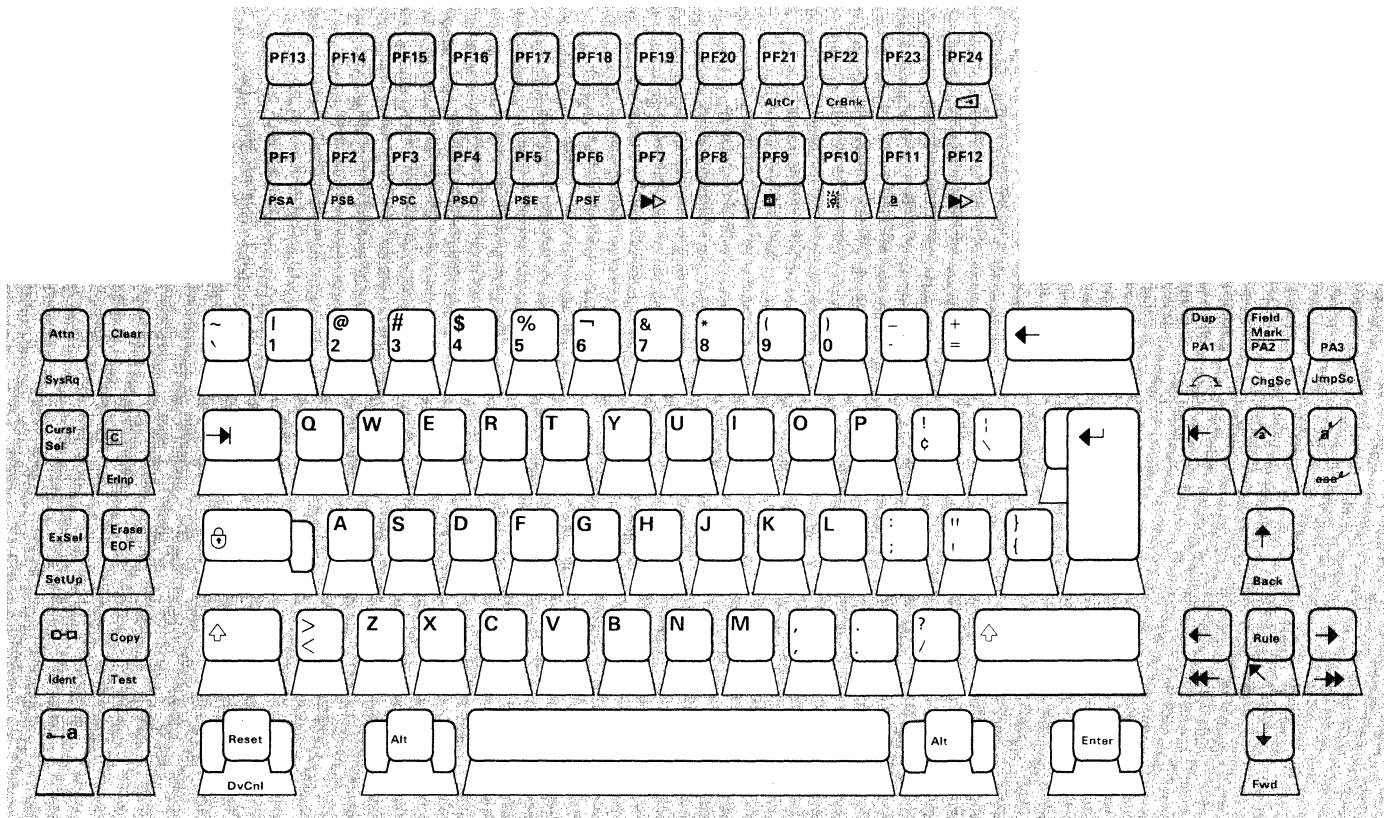

Alphabetic Keys

Enter alpha characters.

The characters on the faces of the Alpha keys (A through Z) are displayed at the current cursor position as uppercase (capital) letters when the keys are used with the Shift (\uparrow) or Lock (\mathbb{L}) keys, or if your 3290 is in monospace mode. In monospace mode, only uppercase alpha characters are displayed, but the program still recognizes the difference between alpha characters entered in uppercase and in lowercase. When the Alpha keys are used without the Shift or Lock keys and your 3290 is in dual-case mode, the letters appear as lowercase letters. All Alpha keys are typematic if held down.

If the cursor is not at the last position of an unprotected field, it moves to the next position in that field.

If the cursor is at the last position of an unprotected field, and the next field is either (1) alphanumeric or (2) numeric and unprotected, the cursor moves to the first position of the next field.

If the cursor is at the last position of an unprotected field, and the next field is numeric and protected, the cursor moves to the first character location of the next unprotected field.

If the cursor is in a protected field or at an attribute location when you press an Alpha key, $\times \leftarrow \rightarrow$ appears. Press Reset to remove this indicator and to unlock the keyboard.

Alternate Shift Keys

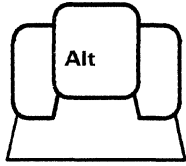

Allow you to select the functions on the front of the keys.

Press and hold either Alt key to enable the following alternate function keys:

SysRq	ErInp
DvCnl	SetUp
AltCr	
Test	JmpSc
ChgSc	Fwd
Back	▶▶ (Highlighting)
↵	▶▶ (PS keys)
CrBnk	
	<u> </u>
	PSA through PSF
Ident	

On APL keyboards, the following additional keys are alternate function keys:

APL		
I		
▽	∇	⊖
∇	△	⊕
△	!	⊗
⊖		⊘
⊗		

APL Character Keys

Enter APL characters in APL mode.

APL characters can be entered from the keyboard when your 3290 is in APL mode. These characters are engraved in orange on APL keyboards. APL characters can also be entered from typewriter keyboards, even though they are not engraved on the keytops.

If the cursor is not at the last position of an unprotected field, it moves to the next position in that field.

If the cursor is at the last position of an unprotected field, and the next field is either (1) alphanumeric or (2) numeric and unprotected, the cursor moves to the first position of the next field.

If the cursor is at the last position of an unprotected field, and the next field is numeric and protected, the cursor moves to the first character location of the next unprotected field.

If the cursor is in a protected field or at an attribute location when you press an APL character key, appears. Press Reset to remove this indicator and to unlock the keyboard.

Dead Keys (Canadian-Bilingual or French Keyboards Only)

Dead keys are available only on keyboards with the Canadian-Bilingual or French language feature. The keys allow you to enter accented characters.

When you press a dead key while holding down either Alt key, the appropriate accent character appears on the screen but the cursor does not move. Next you press a key that, with the accent, forms a valid combination.



Valid accent-and-character combinations are:

Dead Key	Canadian-Bilingual	French
Grave `	à Á è È ù Û	
Acute ´	é É	
Circumflex ^	â Â ê Ê î Ï ô Ô û Û	â ê î ô û
Diaeresis ¨	ë Ë ì Ì ù Ù	ä å ç è é ê ë ì í î ï ð ñ ò ó ô õ ö ø ù
Cedilla ¸	ç Ç	ÿ

The spacebar forms a valid combination with any dead key to produce the accent as a stand-alone character.





After you enter the second character of a dead-key sequence, the cursor moves one position forward as in normal character entry.

You can use the following keys between the operations of the dead key and of the next key, without affecting the dead-key sequence:

-  or 
- 
- CrBnk
- AltCr
- Alt

Pressing a dead key followed by pressing Reset cancels the dead-key operation and produces a stand-alone accent at the cursor position. The cursor does not move.

If you try to enter an invalid combination, the accent is displayed as a stand-alone character, and one of the following indicators appears in the operator information area:

- X  + ?
- X  + ?
- X  + ?
- X  + ?
- X  + ?

Note that the accent in the invalid combination appears as part of the indicator.

Press Reset to remove this indicator and to unlock the keyboard. To correct the error, retype both the accent and the character.

Device Cancel Key

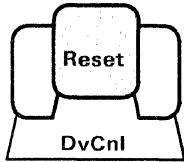

Cancels a pending print request to the printer.

Press DvCnl while holding down either ALT key to recover from a do-not-enter condition caused by a print operation.

Use DvCnl to cancel the print operation and to restore the keyboard when any of the following appears in the operator information area:

- ✘ □ □ ● Printer Busy
- ✘ □ □ ● ● Printer Very Busy
- ✘ □ □ Print Not Working

Note: The DvCnl key can cancel the printing only of data that has not yet been sent to the printer. For this reason, some or all of your data may be printed even if you press DvCnl.

Enter Key

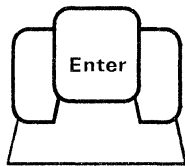

Transmits data from the active partition to the application program.

When you press Enter with the ■ or ☒ displayed, your 3290 transmits data from the active partition to the application program. If neither indicator is displayed, ✘ -f appears. Press Reset to remove this indicator and to restore the keyboard.

This key does not change the keyboard shift status of your 3290, but it does cancel insert mode.

If you have only one partition and press Enter, ✘ ● appears; if you have multiple partitions and press Enter, ✘ ←●→ appears. In either case, your keyboard locks and one of the following occurs:

- ✘ ● or ✘ ←●→ remains, and the keyboard remains locked, if the application program does not reply.
- ✘ ● or ✘ ←●→ disappears, and the keyboard unlocks, if the application program accepts the signal.
- ✘ SYSTEM appears if the application program rejects the signal. Press Reset to remove this indicator and to unlock the keyboard.

Pressing the Enter key while a previous inbound transmission is being processed causes ✘ ?+ to appear. Press Reset to remove this indicator and to unlock the keyboard.

New Line Key

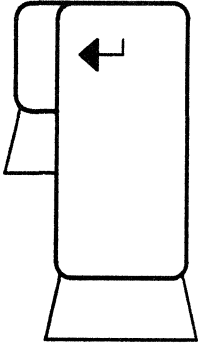

Moves the cursor to the first unprotected position after the current line.



Pressing  moves the cursor to the first unprotected character position after the current line.

If there are no unprotected character positions after the end of the current line, the cursor moves to the first unprotected character in the partition.

If the screen or partition is formatted and there are no unprotected character positions, the cursor moves to row 1/column 1 of the screen or partition.

If the screen or partition is unformatted, the cursor moves to the first character position of the next row.



In a scrollable partition, pressing  can cause autoscrolling.

The New Line () key is a typematic key. The repeat action may cause  to appear. Press Reset to remove this indicator and to unlock the keyboard.

Numeric and Symbol and Punctuation Mark Keys

Enter numeric characters in lowercase, and symbols and punctuation marks in lowercase and uppercase.

Pressing a numeric key displays the digit on the face of the key at the current cursor position.

The Symbol and Punctuation Mark keys are divided into two groups because of their physical locations. The first group contains the symbols that are located on the upper part of the numeric keys. The second group contains those characters located on keys that have two symbols on them. The symbol that appears on the upper part of the key requires pressing the Shift  key or the Lock  key to display it.

The Numeric and Symbol and Punctuation Mark keys are typematic and can cause autoscrolling.

If the cursor is not at the last position of an unprotected field, it moves to the next position in that field.

If the cursor is at the last position of an unprotected field, and the next field is either (1) alphanumeric or (2) numeric and unprotected, the cursor moves to the first position of the next field.

If the cursor is at the last position of an unprotected field, and the next field is numeric and protected, the cursor moves to the first character location of the next unprotected field.





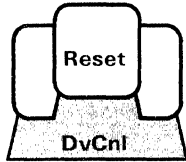

If the cursor is in a protected field or at an attribute location when you press a Numeric or Symbol and Punctuation Mark key,  appears. Press Reset to remove this indicator and to unlock the keyboard.

Reset Key



Resets the keyboard.

Pressing Reset does the following:

- Causes the 3290 to exit insert mode and removes the ^ indicator.
- Cancels a dead-key operation (Canadian-Bilingual and French keyboards only), leaving a stand-alone accent at the cursor position.
- Unlocks the keyboard and removes any Do Not Enter indicators currently displayed in the operator information area except:
 - Nonresettable machine check (X ) (nnn is a number from 650 to 699.)
 - Security Key (X )
 - Terminal Wait (X )
 - Partition Wait (X )
 - Printer Busy (X )
 - Printer Very Busy (X )
 - Printer Not Working (X )

Note: Pressing Reset may not unlock the keyboard when X ?+ appears.

Spacebar

Enters a space character on the screen.

Whenever the cursor is in an unprotected field and you press the spacebar, a space is entered at the current cursor position. The spacebar is typematic.

If the cursor is not at the last position of an unprotected field, it moves to the next position in that field.

If the cursor is at the last position of an unprotected field, and the next field is either (1) alphanumeric or (2) numeric and unprotected, the cursor moves to the first position of the next field.

If the cursor is at the last position of an unprotected field, and the next field is numeric and protected, the cursor moves to the first character location of the next unprotected field.

If the cursor is in a protected field or at an attribute location when you press the spacebar, X  appears. Press Reset to remove this indicator and to unlock the keyboard.

In a scrollable partition, if the cursor is in the last character position of the viewport, pressing the spacebar causes autoscrolling.

Tab Key

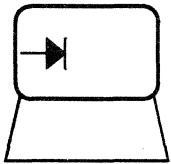

Moves the cursor to the first character position of the next unprotected field.

The Tab (→|) key is a typematic key that allows you to move the cursor from field to field. Press →| to move the cursor to the first character position in the next unprotected field.

If there are no unprotected fields after the current field, the cursor moves to the first character position of the first unprotected field in the partition or screen.

If the partition is not formatted or does not contain unprotected fields, the cursor moves to row 1/column 1 of the screen or partition.

In a scrollable partition, this key can cause autoscrolling. If the repeat action causes autoscrolling, ✕ ?+ may appear. Press Reset, and try again.

Backspace Key

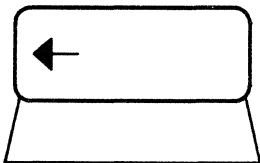

Moves the cursor to the left.

Press ← to move the cursor to the left, one position at a time. This key is typematic. If you hold down ←, the cursor wraps and reappears one line higher on the right side of the viewport.

Uppercase Shift and Uppercase Shift Lock

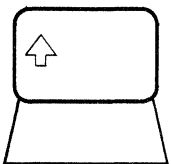

Places the keyboard in uppercase shift condition.

When you hold down either the left or right ↵ key, pressing a key that has two characters marked on its keytop causes the upper of the two characters to be displayed at the current cursor position. With the keyboard in the uppercase shift condition, ↵ appears in the operator information area.

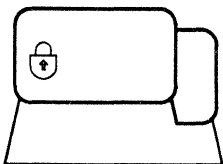

When you hold down either ↵ key, and you press an alphabetic key, the uppercase character is displayed. If you are not in uppercase shift, and an alpha key is pressed, the lowercase character is displayed. However, if your 3290 is in monospace mode, only uppercase alphabetic characters are displayed, but the program still recognizes the difference between alphabetic characters entered in uppercase and lowercase.

Pressing 🔒 locks the keyboard in the uppercase shift condition. Press either ↵ key when you are ready to return the keyboard to the lowercase shift condition.

Pressing either ↵ key overrides the restrictions imposed by the Keyboard Numeric Lock feature.

Appendix A. Examples of Setup and Screen Management

This appendix demonstrates, by example, some of the unique 3290 functions. The first example demonstrates how to place the 3290 in setup mode and how to use setup level 1 to modify a field and to use the rule function. The second example demonstrates how to place the 3290 in setup level 2 to establish multiple interactive screens. The third example demonstrates how to use setup level 1 to establish and use the 3290 copy screen function. The fourth example demonstrates how to place the 3290 in setup level 3 to change screen formats; it also illustrates the advantages of partitioning and the use of the Jump Partition key to advance from one partition to another.

To get the most out of these examples, you should:

1. Read Chapter 3 before doing the examples.
2. Actually use a 3290 and do each example in sequence.

Example 1: Rule Function

This example demonstrates how to modify a field in setup level 1, and how to use the rule function. Be sure the 3290 is connected to a 3274 controller (no host attachment is necessary).

Do each step in sequence:

1. Press the Setup key while holding down either Alt key.

This places the 3290 in setup mode and invokes setup level 1.

<1> should appear on the left side of the operator information area.

2. Move the cursor to the right, under RN or RC.
3. Press the CursrSel key several times. RN and RC alternately appear above the cursor; leave RN above the cursor.
4. Press the SetUp key while holding down either Alt key. This causes the 3290 to exit setup mode.
5. Press the Rule key several times. Notice that the rule line is turned on and off on the same line as the cursor. Leave the rule line on.
6. Move the cursor up or down. Notice that the rule line does not follow the cursor.
7. Press the Rule key to turn off the rule line.
8. Now, place the 3290 in setup mode, invoking setup level 1, and put the cursor under RC. To do this:

- a. Press the Setup key while holding down either Alt key.

This places the 3290 in setup mode and invokes setup level 1. 1 should appear on the left side of the operator information area.

- b. Move the cursor to the right, under RN.
- c. Press the Cursr Sel key to change RN to RC.
9. Press the Setup key while holding down either Alt key. This causes the 3290 to exit setup mode.
10. Press the Rule key to turn on the rule line. Notice that the rule line is on the same line as the cursor.
11. Move the cursor up or down. Notice that the rule line follows the cursor.

Example 2: Multiple Interactive Screens

This example assumes that only one large screen (not a divided screen) appears when the 3290 is turned on, and demonstrates how to establish multiple interactive screens using setup level 2.

Setting up for multiple interactive screens is done by attaching the 3290 to a 3274 port that has been customized for multiple addresses. Refer to "Customizing for the Multiple Interactive Screens Function," in Chapter 3.

Before proceeding with this example, terminate any interactive sessions with the host.

Do each step in sequence:

1. Press the Setup key while holding down either Alt key.

This places the 3290 in setup mode and invokes setup level 1. <1> should appear on the left side of the operator information area.

2. Move the cursor all the way to the right, under the ◇ .
3. Press the CursrSel key. <2> should replace <1> in the operator information area, indicating that the 3290 is in setup level 2.

The center of the operator information area now contains up to six boxes, each preceded by a letter (A through F). Each letter is a logical terminal set label. The number in each box represents the number of defined logical terminals in the logical terminal set. Notice that one logical terminal set (box preceded by a letter) is highlighted by reverse video. This identifies the logical terminal set currently in use.

4. Move the cursor under a label next to a box that contains a number greater than 1. This number determines the number of logical terminals you will get. If possible, choose a logical terminal set other than the one that is highlighted.
5. Press the CursrSel key. Notice that your selection is now highlighted.
6. Press the Setup key while holding down either Alt key. This causes the 3290 to exit setup mode.

Your panel now represents the new logical terminal set. Notice the logical terminal identifier on the right side of the operator information area, just to the left of the Row/Column field. This identifies the active screen, which is the screen where the cursor is located. If your system or application presents a LOGO, indicating it is ready for use, that LOGO should be displayed on every logical screen on the panel.

If the 3290 is properly attached to a host system, you may now log or sign on to an application from the active screen.

7. Press the JmpSc key while holding down either Alt key.

The cursor moves (jumps), clockwise, to the next logical screen, and the logical terminal identifier changes.

You may now log or sign on to the same or a different application, depending on your system or application configurations, from the new active screen.

You may use the JmpSc key (while holding down either Alt key) to make another logical screen (application) the active screen.

8. Terminate all sessions with the host. Make another logical screen the active screen, and terminate each session with the host.

You may want to choose another logical terminal set, or return to the terminal set that was in use when you started this example. To do this, repeat steps 1 through 5 above.

The number of logical screens is limited only by:

- The number of logical terminal addresses (maximum of 5) customized for the physical port your 3290 is attached to.
- The number of logical terminals (up to 4 at any one time) defined for a logical terminal set.

Example 3: Copy Screen

This example demonstrates how to initiate a screen copy. It shows how a logical screen can become a copy screen.

Do each step in sequence:

1. If your 3290 is not already set up for multiple interactive screens, go back to Example 2 and use setup level 2 to choose a logical terminal set that provides multiple logical terminals.

Note: This example is based on two logical terminals (two screens), but you should be able to follow along if your 3290 is set up for four logical terminals (four screens).



2. Press the SetUp key while holding down either Alt key.

This places the 3290 in setup mode and invokes setup level 1. <1> should appear on the left side of the operator information area.

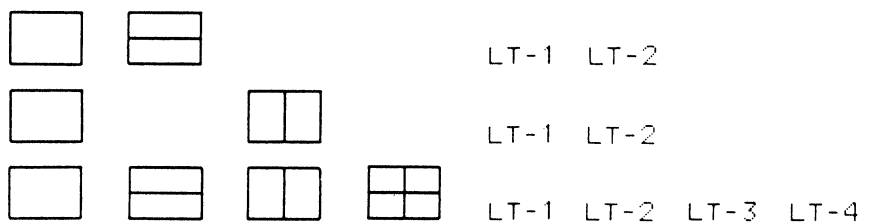
The operator information area should contain one of the following:



Note: LT-1, LT-2, LT-3, and LT-4 are the IBM-supplied identifiers.

Either a 2-way split ( ) or a 4-way split () should be highlighted by reverse video. At least two logical terminal identifiers (LT-1, LT-2, for example) should be displayed. Move the cursor under one of the split symbols, one that is not highlighted, and press the Cursr Sel key. Notice that this symbol becomes highlighted and the screen split changes accordingly unless you are in Zoom mode.

3. Move the cursor under the second logical terminal identifier.
4. Press the CursrSel key several times. Notice that the symbol cycles through the screen use designators, including all the logical terminal identifiers and the copy screens  symbol. Leave the copy screen symbol displayed.
5. Press the Setup key while holding down either Alt key. This causes the 3290 to exit setup mode.

You have placed a logical screen in the background queue, and that screen has become a copy screen.

6. If the foreground logical screen is empty, type something—for example, *Four score and seven years ago*.

7. Press the Print key (→) to place the 3290 in copy screen mode.
→ appears in the operator information area.
8. You should see these kinds of symbols in the operator information area:
 - Copy the active logical screen to printer. (The *active* screen is the screen that was active when the 3290 entered copy screen mode.)
 - Logical screen, not a copy screen.
 - Copy screen.
9. Move the cursor under a copy screen symbol → and press the CursrSel key. The active logical screen is copied to the copy screen. An symbol represents a logical screen that you cannot copy into. The cursor bypasses this position.
10. Press the Clear key to clear the information that was just copied.
11. Press the Print key → to exit copy screen mode.

Example 4: Modifying Screen Characteristics

This example demonstrates how to place the 3290 in setup mode and how to use setup level 3 to modify screen characteristics. Any modifications made to screen characteristics in setup level 3 and verified by validation option 2 remain in effect until the next time the 3290 receives a downstream load. The changes can be made permanent (see Chapter 3), but not for this example.

Setup level 3 uses the entire panel to display tables, some of which you will learn how to modify. Each table is in a separate partition. The jump partition (↶↷) key is used to move the cursor from one table to another. The normal Cursor Move keys can be used to move the cursor within each table.

The information displayed in setup level 3, for this example, is the IBM-supplied values. The information on your screen may be different; however, you should follow along in the example, and make the changes to the corresponding information fields on your screen.

Note: Do not be afraid to make changes during this example. The final steps of the example will restore your 3290 to the state it was in when you started the example.

During the example, the tables on the screen are altered to provide the following characteristics:

- Alternate row and column size (43 x 80)
- Variable character cell size
- Extended attributes not enabled
- No programmed symbol sets
- Partitioning allowed
- 8 partitions per logical terminal
- Scroll enabled
- No numeric lock
- Default - logical terminal set F
- Usable area type 3 (vertical split)
- Making of the screen area assigned to the second logical terminal a copy screen.
- Default - vertical split screen

Do each step in sequence:

1. Press the SetUp key while holding down either Alt key. This places the 3290 in setup mode and invokes setup level 1. <1> should appear on the left side of the operator information area.
2. Move the cursor all the way to the right, under the ◇ .
3. Press the CursrSel key. <2> should replace <1> in the operator information area.
4. Again, move the cursor all the way to the right, under the ◇ .
5. Press the CursrSel key again. <3> should replace <2> in the operator information area, and your screen should look like the one shown in Figure A-1.

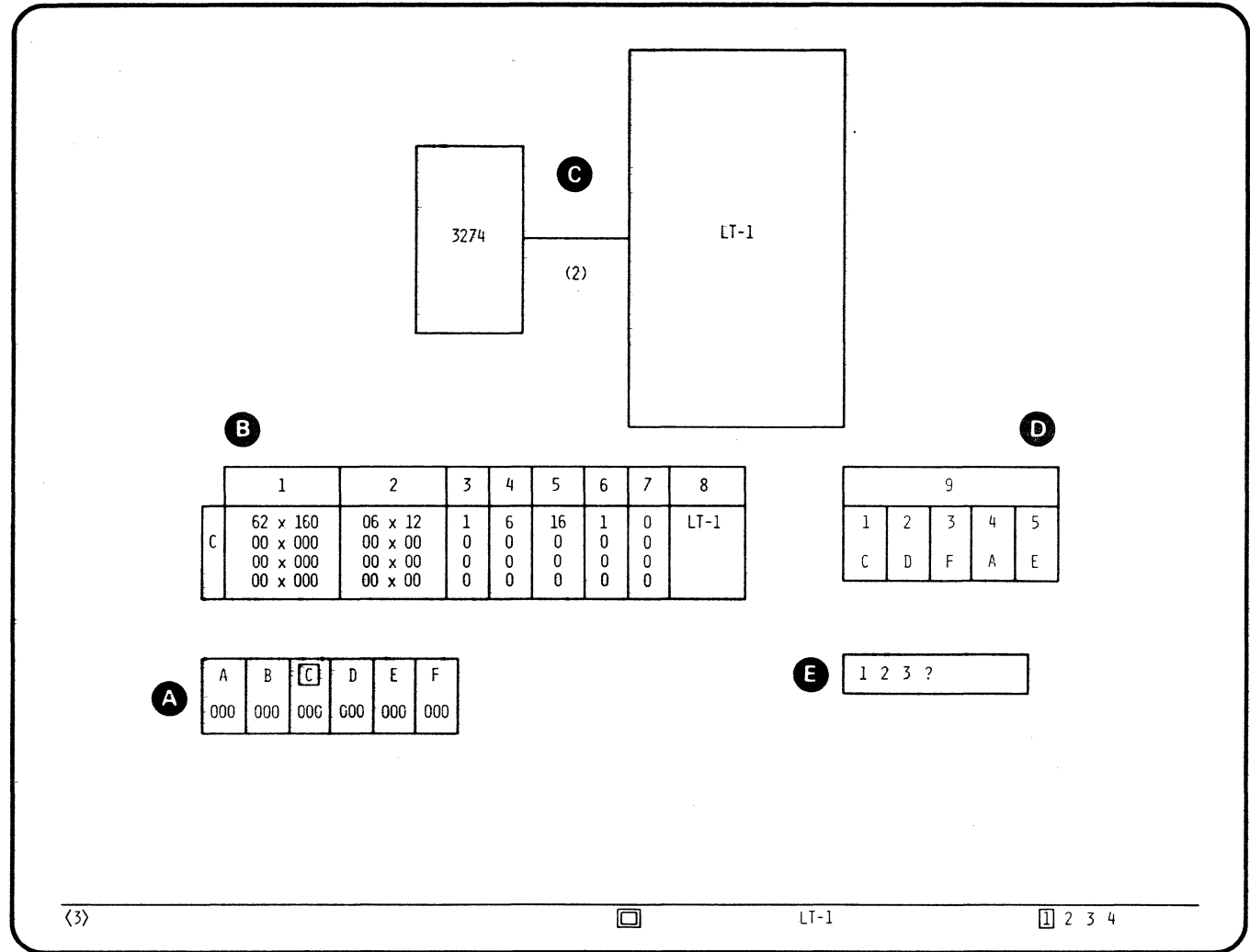







Figure A-1. IBM-Supplied Values for Logical-Terminal Set C

6. Press the Jump Partition () key several times. Notice that the cursor moves (jumps) from partition **A** to **B** to **D** to **E**, then to the operator information area, and around again. Partition **C** cannot be changed. Leave the cursor at partition **A**.
7. In partition **A** move the cursor under **F** and press the CursrSel key. This selects the screen characteristics for logical-terminal set **F**. Partitions **B** and **C** and the operator information area are rewritten to reflect these characteristics.
8. Advance the cursor to partition **B** by pressing the  key.
9. Replace the first two rows of information in partition **B** with the following:

Column	1	2	3	4	5	6	7	8
	43X80	00X00	0	0	08	1	0	LT-1
	43X80	00X00	0	0	08	1	0	LT-2

10. Advance the cursor to partition **D** by pressing the  key.

Notice the (2) in partition **C**. This indicates that your 3290 is on a port configured with two logical addresses. Therefore, in partition **D**, the logical-terminal set whose label is displayed under the 2 is the default logical-terminal set for your 3290. (For this example, logical-terminal set **C** is the default.)
11. In partition **D**, move the cursor under 2 and replace the **D** with **F**. This indicates that any 3290 on a port that has two logical addresses will default to logical terminal set **F**. Therefore, **F** is the default logical terminal set for your 3290.
12. Advance the cursor to the operator information area by pressing the  key.
13. In the operator information area, move the cursor under the 3 (on the far right).
14. Press the CursrSel key. The 3 is displayed in reverse video.
15. Move the cursor to the left, under the .
16. Press the CursrSel key. The is displayed in reverse video.
17. Move the cursor to the right, under LT-2.
18. Press the CursrSel key. A copy-screen symbol appears.

19. Advance the cursor to partition **E** by pressing the  key.

You have completed the changes to the screen characteristics. At this point, you normally have three options:

- Option 1 – Validate the changes.
- Option 2 – Validate and *temporarily* store the changes in the 3290.
- Option 3 – Validate and store the changes permanently on the 3290 load diskette in the 3274.

If you were to choose option 3, you would be prompted for a password giving you authority to make these changes.

20. Choose option 1, in partition **E**, by placing the cursor under 1 .

21. Press the CursrSel key.

If validation fails, a 3-digit error code appears in partition **A** under the logical-terminal set in question (in this case — logical-terminal set F). See Appendix C for a list of the setup level 3 error codes. Three zeros (000) means a successful validation.

Note: An error affects only the current logical-terminal set. It can be bypassed by selecting another set.

22. To exit setup mode, press the SetUp key while holding down either Alt key.

Now, the 3290 is the same as it was before you started this example. All the changes you made have been discarded, because you selected option 1 above.

Appendix B. Error Code Charts

This appendix contains the error codes that may appear on the 3290 screen when power is turned on or during operation. They are for determining where a problem exists if it is not in the 3290 .

Indications during Power-On Sequence (3274-Detected Errors)

During Initiating of Downstream Load

Error Code	Probable Cause	Action
1000 0010	3274 diskette not ready.	<ol style="list-style-type: none"> 1. Ensure that the correct diskette is in the 3274, that it is properly inserted, and that the diskette drive door is closed. 2. Turn 3290 power off, then on again. 3. Wait 2 minutes (testing). 4. If the problem persists, follow local procedures for reporting problems.
1000 0011 1000 0100 1000 0101 1000 0110	Requested file cannot be found. 3274 failure 3274 machine check Sync Check—failure to execute microcode.	<ol style="list-style-type: none"> 1. Turn 3290 power off, then on again. 2. Wait 2 minutes (testing). 3. If the problem persists, follow local procedures for reporting problems.

During Downstream Load

Error Code	Probable Cause	Action
□ nnnn 0010	3274 diskette not ready.	<ol style="list-style-type: none"> 1. Ensure that the correct diskette is in the 3274, that it is properly inserted, and that the diskette drive door is closed. 2. Turn 3290 power off, then on again. 3. Wait 2 minutes (testing). 4. If the problem persists, follow local procedures for reporting problems.
□ nnnn 0011 □ nnnn 0100 □ nnnn 0101 □ nnnn 0110	Requested file cannot be found. 3274 failure 3274 machine check Sync Check—failure to execute microcode.	<ol style="list-style-type: none"> 1. Turn 3290 power off, then on again. 2. Wait 2 minutes (testing). 3. If the problem persists, follow local procedures for reporting problems.

Indications during Operation

3274-Detected Machine Check Errors

The 2nn/3nn (n = a number 0–9) error code numbers are sent by the 3274 Control Unit. (See Appendix A in *3274 Control Unit Description and Programmer's Guide*, GA23-0061.)

3274-Detected Program Checks

The 4nn (n = a number 0–9) error code numbers are sent by the 3274 Control Unit. (See Appendix A in *3274 Control Unit Description and Programmer's Guide*, GA23-0061.)

Communication Check Errors

3290-Detected: 590 – Control unit no longer responding to device request.

3274-Detected: The 5nn (n = a number 0–9) error code numbers are sent by the 3274 Control Unit. (See Appendix A in *3274 Control Unit Description and Programmer's Guide*, GA23-0061.)

3290-Detected Machine Check Errors

The 6nn error code numbers listed below are detected by the 3290 terminal.

Error Code	Probable Cause	Action
620	Invalid keyboard scan code	<ol style="list-style-type: none">1. Press the Reset key and try again.2. If the problem persists, turn power off, then on again, and retry the operation.3. If the problem still exists, go to <i>IBM 3290 Information Panel Customer Problem Analysis and Resolution</i>, GA23-0125.
630	Unknown diskette or hardware error	<ol style="list-style-type: none">1. Press the Reset key and try again.2. If the problem persists, follow local procedures for reporting problems.3. When the problem is resolved, press the Reset key and retry the operation.
631	Diskette file not found	<ol style="list-style-type: none">1. Press the Reset key and try again.2. Check that the correct diskette is in the 3274.3. If the problem persists, follow local procedures for reporting problems.4. When the problem is resolved, press the Reset key and retry the operation.

Error Code	Probable Cause	Action
632	Diskette media error	<ol style="list-style-type: none"> 1. Press the Reset key and try again. 2. Replace the diskette. 3. If the problem persists, follow local procedures for reporting problems. 4. When the problem is resolved, press the Reset key and retry the operation.
633	Diskette overrun	<ol style="list-style-type: none"> 1. Press the Reset key and try again. 2. If the problem persists, follow local procedures for reporting problems. 3. When the problem is resolved, press the Reset key and retry the operation.
634	Unable to write to diskette file	<ol style="list-style-type: none"> 1. Check that the correct diskette is in the 3274. Press the Reset key and retry the operation. 2. If the problem persists, follow local procedures for reporting problems. 3. When the problem is resolved, press the Reset key and retry the operation.
635	Diskette not ready	<ol style="list-style-type: none"> 1. Check that the correct diskette is in the 3274. Press the Reset key and retry the operation. 2. If the problem persists, follow local procedures for reporting problems. 3. When the problem is resolved, press the Reset key and retry the operation.
636	Diskette file locked (File is being used by another operator)	<ol style="list-style-type: none"> 1. Press the Reset key and wait until other is finished before trying again. 2. If the problem persists, follow local procedures for reporting problems. 3. When the problem is resolved, press the Reset key and retry the operation.
637	Diskette file overflow	<ol style="list-style-type: none"> 1. Press the Reset key and try again. 2. If the problem persists, follow local procedures for reporting problems.
638	Not able to read the diskette file	<ol style="list-style-type: none"> 3. When the problem is resolved, press the Reset key and retry the operation.
639	Diskette file not locked	

Error Code	Probable Cause	Action
640	Wrong diskette in 3274	1. Make sure the correct diskette is in the 3274. Press the Reset key and try again. 2. If the problem persists, follow local procedures for reporting problems. 3. When the problem is resolved, press the Reset key and retry the operation.
650	Translate table array	1. Turn power off, then on again. 2. Retry the operation. 3. If the problem persists, turn power off, then on again, and refer to <i>IBM 3290 Information Panel Customer Problem Analysis and Resolution</i> , GA23-0125.
651 652	Panel adapter error	
653	Storage parity or data error	
654	3274 to device protocol error	
661 to 668	Storage parity or data error	1. Turn power off, then on again. 2. Retry the operation. 3. If the problem persists, turn power off, then on again, and refer to <i>IBM 3290 Information Panel Customer Problem Analysis and Resolution</i> , GA23-0125.
690	Error queue overflow	
698	Asynchronous status queue overflow	
699	A machine check detected within the terminal cannot be isolated in more detail.	

Notes:

1. Error code numbers 620 through 640 are resettable.
2. Error code numbers 650 through 699 are nonresettable.
3. The following failures are also recorded in the 3274 error log:

3290 Error Code	3274 Error Code
630	389
632	388
633	386

Program Error Codes

The following is a list of error status codes to be displayed by the 3290 Display Unit for the specified program checks. These codes fall into two groups. The codes in the first group, 701 to 730, signify an attachment-dependent error condition. The codes in the second group, 750 to 772, signify an attachment-dependent device error condition. Recovery for both groups is obtained by pressing the Reset key, to reset the program check status, and retrying the operation.

If the same problem persists, the operator should contact the host support programmer.

Error Code	Probable Cause	Effect (SNA Sense Code or Non-SNA OP-Check)	Action
701	Category not supported	1007	<ol style="list-style-type: none"> 1. Press the Reset key and try again. 2. If the problem persists, follow local procedures for reporting problems.
702	RU > 1,536 bytes received (SNA buffer overrun condition)	1002	
703	Function not supported: Unsupported Session Control request Unsupported Data Flow Control request Invalid Signal request code (not 0001XXXX)	1003 OP-CHK	
704	Format indicator (FI) bit not allowed	400F	
705	Sequence number error	2001	
706	Chaining error	2002	
707	Bracket state error	2003	
708	Data traffic reset state	2005	
709	HDX error	2004	
711	Session limit exceeded	0805	
712	Bracket bid reject	0813	
713	Session already bound	0815	
714	No LU-LU session	8005	
715	LU not active	8009	

Error Code	Probable Cause	Effect (SNA Sense Code or Non-SNA DP-Check)	Action
716	Not enough bytes in the BIND RU	0821	1. Press the Reset key and try again. 2. If the problem persists, follow local procedures for reporting problems.
717	Invalid support level (bytes 1—3)	0821	
718	Invalid PLU protocol (byte 4)	0821	
719	Invalid SLU protocol (byte 5)	0821	
720	Invalid common protocol (bytes 6—7)	0821	
721	Less than 64-byte RU length specified (byte 10)	0821	
723	Invalid LU type (byte 14)	0821	
724	Invalid screen size (bytes 20—24)	0821	
725	Cryptography not supported (byte 26)	0821	
726	Negative SNA response from the host	_____	
727	SNA Exception Request received	_____	
728	An RM, RMA, or RB command or a Read Partition SF type received with EB and/or CD	0829	
729	A Read Partition SF type received in retry state	0871 DP-CHK	
730	A Read Buffer command received in normal state, and partition 0 does not exist.	1005	
750	Invalid command received	1003 DP-CHK	
751	SFE, MF, or SA order with invalid character set value in the range X'01' — X'FE'.	0863 DP-CHK	

Error Code	Probable Cause	Effect (SNA Sense Code or non-SNA OP-Check)	Action
752	Invalid address received following an SBA, RA, or EUA order. MF order addressed to a nonfield attribute location.	1005 OP-CHK	<ol style="list-style-type: none"> 1. Press the Reset key and try again. 2. If the problem persists, follow local procedures for reporting problems.
753	Data follows an RM, RMA, RB, or EAU command. GE or RA order received with invalid character. SFE, MF, or SA order with invalid attribute value for highlight or color or a character set value of X'FF'.	1003 OP-CHK	
754	Data stream ended before all required bytes for an SBA, RA, EUA, SF, SFE, MF, SA, or GE order were received.	1005 OP-CHK	
755	Invalid order received (EBCDIC value less than X'40' not recognized) EOs or subcontrol code received while 3290 was configured for non-EAB.	1003 OP-CHK	
756	Invalid structured field type. Structured field type not supported for current configuration.	1003 OP-CHK	
757	Load PS SF with invalid PS alias Load PS SF load type not supported	1003 OP-CHK	
758	Set reply mode SF received with invalid mode	1003 OP-CHK	
759	Read Partition SF not last SF SF type incomplete SF length invalid Set Reply Mode SF with field/ext field mode and data following SF length 0000 but not last SF Load PS SF length error	1005 OP-CHK	
760	Erase/Reset SF reserved fields not zero Set Reply Mode SF attribute type reserved	1003 OP-CHK	

Error Code	Probable Cause	Effect (SNA Sense Code or non-SNA OP-Check)	Action
761	SF type PID invalid, not created, or non-zero in implicit partition state Query PID not X'FF' 3270 command received in explicit partition state and PID 0 does not exist	1005 OP-CHK	<ol style="list-style-type: none"> 1. Press the Reset key and try again. 2. If the problem persists, follow local procedures for reporting problems.
762	Create Partition SF parameter error Set Window Origin SF parameter error	1005 OP-CHK	
763	Create Partition SF caused a viewport overlap Create partition SF rejected because of sufficient resources	1005 OP-CHK	
764	Load PS SF addressed PS invalid Load PS SF extension- invalid color bits	084C OP-CHK	
765	Load PS SF with invalid load start point Load PS SF with invalid code point of X'FF'	1005 OP-CHK	
766	Load PS SF with incomplete PS cell data Load PS SF with invalid end flag for type 2 PS Load PS SF with invalid type 2 header (end flag encountered and not end of data)	1005 OP-CHK	
767	Create Partition SF with invalid address mode Create Partition SF with bits (0-3) of byte 4 not zero	1003 OP-CHK	
768	Load PS SF extension Invalid x units Invalid y units Invalid extended parameter length or Extended parameter length if missing	1005 OP-CHK	

Error Code	Probable Cause	Effect (SNA Sense Code or non-SNA OP-Check)	Action
769	Load PS SF extension Invalid byte 8 Reserved bits 3 to 7 not zero Byte 11 not zero Byte 12 bits 5 to 7 not zero	1003 OP-CHK	<ol style="list-style-type: none"> 1. Press the Reset key and try again. 2. If the problem persists, follow local procedures for reporting problems.
770	Structured field type (exc 3270E) with start print in WCC, but not last structured field	1001 OP-CHK	
771	Invalid command in structured field	1003 OP-CHK	
772	Resource requested temporarily unavailable. Create Partition: No partition allocated to the LT. Number of partitions allocated to the LT has been exceeded. Scroll buffer specified but not allowed. Set Attribute, Modify Field, Start Field Extended: PSA—PSF requested, but PS has not been allocated to the LT. Load PS PS has not been allocated to the LT.	084B OP-CHK	

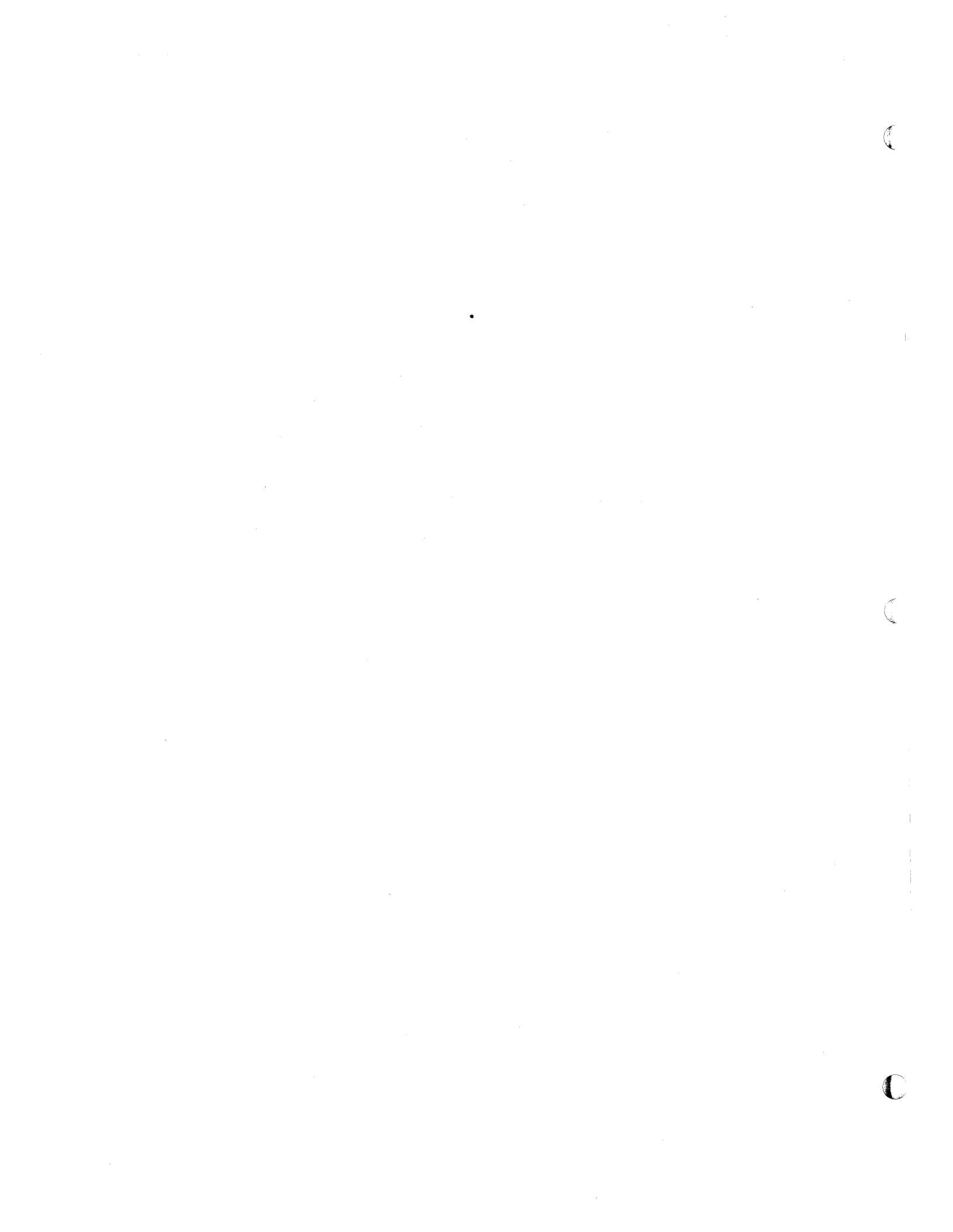

Appendix C. Setup Level 3 Error Codes

This appendix defines the setup level 3 error codes.

Error Code	Definition
101	Skipped Logical-Terminal Definition Logical terminal 1 must always be defined, and entries must be defined sequentially.
102	Alternate Screen Size Not Defined The alternate screen size for a logical terminal is 0, and some other field such as character size is defined.
103	Partial Alternate Screen Size Defined The row or column field for the alternate screen size is zero.
104	Alternate Screen Size Row Definition Greater Than 62 The row field for alternate screen size is greater than 62.
105	Alternate Screen Size Column Definition Greater Than 160 The column field for the alternate screen size is greater than 160.
106	Cell Height Not Defined The cell height field is zero when the cell width field is defined.
107	Cell Width Not Defined The cell width field is zero when the cell height field is defined.
108	Cell Width Definition Greater Than 12 The cell width field is greater than 12.
109	Cell Width Definition Less Than 6 The cell width field is less than 6. Note: A cell width and height of 00 x 00 is valid.
110	Cell Height Definition Greater Than 31 The cell height field is greater than 31.
111	Cell Height Definition Less Than 12 The cell height field is less than 12. Note: A cell width and height of 00 x 00 is valid.
112	PS Specified and Extended Attributes Not Enabled The PS sets are configured, and the extended attributes field is not enabled (0).
113	One PS Specification per Logical-Terminal Definition Set More than one logical terminal has the PS sets configured.
114	Invalid Number of Partitions Specified The number of partitions specified is not 0, 8, or 16.
115	Number of Partitions Greater Than 16 The sum of all the partitions specified for the logical-terminal set exceeds the device maximum of 16.
116	Scrolling Enabled without Partitions Scrolling is enabled without partitions being defined for this logical-terminal set.
117	Logical-Terminal Set Height and Width Greater Than the Specified Usable Area The maximum height and width for this logical-terminal set (based on the cell size and the default screen size (24 x 80), or alternate screen size) is greater than the usable area specified in the operator information area.
120	Invalid Logical-Terminal Set Character Entry The character specified in columns 1—7 is not numeric. In addition, the extended attributes, scroll, and numeric lock fields are not 1 or 0, or the PS field is not 0 or 6.
121	Operator Information Area Error No logical screens have been specified, or the same logical screen has been specified twice.

Error Code	Definition
122	<p>Display Buffer Exceeded The total of the maximum buffer requirement for the alternate or default screen sizes for this logical terminal set exceeds the device display buffer limit of 24K.</p> <p>Note: Extended attributes enabled, if specified, doubles the column buffer requirements for the associated logical-terminal set entry. Also, for each row defined, there is an associated 2-byte field that must be accounted for.</p>
201	<p>Invalid Logical-Terminal Set Specified The logical-terminal set specified for the given number of logical terminal addresses is invalid (see Figure 3-5).</p>
202	<p>Invalid Password The password specified does not match the password defined during customization.</p> <p>Note: The password is validated only for a type 3 scan selection.</p>
203	<p>Invalid Character for Logical-Terminal Symbol The character specified in the logical-terminal symbol field is not A, B, C, D, E, F, or blank.</p>

Glossary

A

active logical screen. The logical screen that contains the cursor.

active logical terminal. The logical terminal that contains the cursor.

active partition. The partition in which the cursor is located.

B

background screen. A screen that is not displayed but can interact with the host.

C

character cell. An addressable location on the display surface used to display characters.

copy screen. An unbuffered screen area into which data can be copied.

D

dead key. A key on Canadian-French keyboards that provides an accent mark for certain characters that cannot be typed from combined character-and-accent keys.

display space. The area of the panel above the separator line.

Do Not Enter. A symbol (X) in the operator information area that indicates to the operator that data cannot be entered.

F

foreground screen. A screen that is displayed during normal operation of the 3290. A foreground screen is not displayed in zoom mode (unless it is the active screen), in test mode, or in setup level 3.

H

home position. The first unprotected character position in a screen or partition.

I

image limit. A condition that occurs when the maximum number of PELs are lit on the 3290.

L

loadable character set. A character set that is not permanently stored in the device.

logical screen. The data that is actually displayed, based on the status of the logical terminal.

logical terminal. In a 3290 environment, a software simulation of a physical terminal. More than one logical terminal can exist in the 3290, and each can interact with the host.

N

nonloadable character set. A character set installed in the device that must be used as it is. This character set cannot be extended or altered by the user.

null character. An empty character position that can be filled by characters entered either from the keyboard or by the host program.

O

operator information area. The area of the panel below the separator line that is reserved for symbols and messages informing the operator of the operational status of the 3290.

P

partition. All or a portion of the screen area of a display space ⁶⁴ and its character buffer. Data is presented within the partition through a viewport that is defined when the partition is created. Data is logically stored in the presentation space, and that portion of the data that is within the window may be displayed in the viewport.

PEL. Picture element.

picture element. The smallest element of a display space that can be produced on the 3290.

protected field. On a display device, a field in which the operator cannot enter, modify, or erase data.

R

reverse video. A means of highlighting a character or a field by reversing the light intensity between the character and its background; for example, changing a normally black-on-white character to a white-on-black character.

ruling line. A single horizontal line under one row of characters within a logical screen or partition.

S

screen area. A portion of the display space.

separator line. A line that appears near the bottom of the panel to separate the display space from the operator information area.

U

unprotected field. On a display device, a field in which the operator can enter, modify, or erase data.

Z

zoom. A function that displays the active logical screen or partition in the largest allowable character size.



Index

- active logical screen 3-1
- alpha indicator 5-16
- alphabetic keys 6-26
- alternate cursor key 6-20
- alternate screen size 3-15
- alternate shift keys 6-27
- APL character keys 6-27
- APL indicator 5-16
- APL key 6-20
- APL-text character set 3-4
- assign printer status indicator 5-19
- attention identifier byte 4-17
- attention key 6-6
- attribute 4-4
- audible alarm control 5-4

B

- background queue 3-2
- backspace key 6-32
- backtab key 6-14
- Basic Assurance Test Sequence 5-2
- blink character key 6-21
- buffer 3-6
- buffer addresses 4-31

C

- carriage return 3-20
- change screen key 6-15
- character attributes 4-5
- character cell dimension 4-30
- character cell size
 - height 3-16
 - maximum 3-15
 - minimum 3-15
 - width 3-16
- character row 3-18
- character sets descriptor format 4-27
- clear key 6-7
- clear partition key 6-7
- clicker key 6-21
- clicker volume control 6-3
- communication check 5-10
- communication error reminder 5-15
- control codes 3-20
- controls 5-2
- copy key 6-8
- copy screen indicator 5-8
- copy screen mode 6-10
- copy screen operation 6-11
- copy-viewport 3-8
- cursor 3-10
- cursor blink key 6-21
- cursor down key 6-15
- cursor left key 6-15
- cursor right key 6-15
- cursor select key 6-8
- cursor up key 6-15

D

- data stream functions 4-1
- dead keys 6-28

default

- logical-terminal set 3-11
- screen division 3-3
- screen size 3-15
- usable area 3-3
- defined alternate screen size 3-4
- defined cell size 3-4
- delete character key 6-15
- device cancel key 6-29
- diamond indicator 3-10
- display surface 3-6
- do not enter 5-9
- downstream loading sequence 5-2
- dual-case 3-8
- dup key 6-16

E

- enter key 6-29
- erase input key 6-9
- erase to end of field (EOF) key 6-8
- error codes
 - communication checks B-2
 - during downstream load B-1
 - during initiating of downstream load B-1
 - setup level 3 C-1
 - 3274-detected machine checks B-2
 - 3274-detected program checks B-2
 - 3290-detected machine checks B-2
- ex sel key 6-9
- examples
 - copy screen A-5
 - modifying screen characteristics A-7
 - multiple interactive screens A-3
 - rule function A-2
- explicit partitioned state 3-17
- extended attributes enabled 3-4
- extended field 4-19
- extended field attributes 4-5
- extended highlighting 3-4

F

- field 4-19
- field attributes 4-4
- field format for partitions 01-0F 4-22
- field inherit indicator 6-22
- field mark key 6-16
- foreground screen 3-17
- form feed 3-20

G

- go elsewhere indicator 5-14
- graphic escape 3-20

H

- highlighting 6-23
- highlighting indicators
 - blink
 - field inherit 5-17
 - operator-selected 5-18
 - normal 5-17
 - reverse video
 - field inherit 5-18
 - operator-selected 5-18

- underscore
 - field inherit 5-18
 - operator-selected 5-18
- home key 6-17
- horizontal cursor move keys 3-9

I

- ident key 6-9
- image limit indicator 5-20
- implicit partition state 3-18
- inbound-reply mode 4-15
- inbound 3270 data stream 4-17
- initialization 3-13
- insert mode 3-19
- insert mode indicator 5-19
- insert mode key 6-17
- invalid dead-key combination 5-13

J

- jump partition key 3-11, 6-18
- jump screen key 3-1, 6-18

K

- Katakana indicator 5-16

keyboard

- adjustment 6-3
- cable 6-3
- clicker 6-3
- description 6-1
- ID switches 6-3
- unique keys 6-1
- 104 keys 6-1
- 105 keys 6-1
- 106 keys 6-1

keypad

- adjustment 6-4
- cable 6-4
- calculator 6-1
- program function 6-1

keys

- alphabetic 6-26
- alternate cursor 6-20
- alternate function 6-1
- alternate shift 6-27
- APL 6-20
- APL characters 6-27
- attention 6-6
- backspace 6-32
- blink character 6-21
- change screen 6-15
- clear 6-6
- clear partition 6-7
- clicker 6-21
- copy 6-8
- cursor blink 6-21
- cursor down 6-15
- cursor left 6-15
- cursor right 6-15
- cursor select 6-8
- cursor up 6-15
- dead keys 6-28
- delete character 6-15
- device cancel 6-29
- dup 6-16
- enter 6-29
- erase input 6-9
- erase to end of field 6-8

- exsel 6-9
- field inherit 6-22
- field mark 6-16
- home 6-17
- ident 6-9
- insert mode 6-17
- jump partition 6-18
- jump screen 6-18
- new line 6-30
- numeric 6-30
- print 6-9
- program access (PA) 6-18
- program function (PF) 6-23
- programmed symbol (PS) 6-24
- punctuation 6-30
- reset 6-31
- reverse video 6-25
- rule 6-19
- scroll backward 6-19
- scroll forward 6-19
- setup 6-11
- spacebar 6-31
- symbol 6-30
- system request 6-12
- tab 6-32
- test 6-12
- typematic 6-1
- underscore 6-25
- uppercase shift 6-32
- uppercase shift lock 6-32
- zoom 6-13

L

- load diskette 3-7
- logical screen 3-1, 3-14
- logical terminal
 - co-resident active 3-1
 - defined 3-1
 - definition table 3-11
 - identifier 3-4
- logical terminal addresses 3-11
- logical-terminal ID indicator 5-20
- logical terminal screen size
 - alternate 3-16
 - default 3-16
- logical terminal set label 3-10, 3-13
- logical-terminal sets 3-2
- logical terminals 3-1

M

- machine check indicator 5-10
- minus function indicator 5-12
- minus function,operator-unauthorized 5-12
- monocase mode 3-8, 6-1
- my job indicator 5-9

N

- new line 3-20
- new line key 6-30
- nonloadable character set indicator, field inherit 5-15
- non-SNA channel commands 4-6
- non-SNA protocols 3-21
- normal read state 4-17
- numeric data only 5-13
- numeric keys 6-30
- numeric lock function active 3-4
- numeric shift indicator 5-17

O

- on indicator 5-2
- on/off switch 5-2
- online indicator
 - non-SNA 5-8
 - SNA 5-8
- operator information area
 - in setup mode 3-14
 - location 5-5
- operator-initiated local copy operations 3-9
- operator-unauthorized indicator 5-15
- outbound structured field format
 - activate partition 4-12
 - create partition 4-11
 - destroy partition 4-13
 - erase reset 4-15
 - load programmed symbol 4-10
 - read partition 4-16
 - reset 4-15
 - set reply mode 4-14
 - set window origin 4-13

P

- partition wait 5-14
- partitions 3-4
- password 3-14
- PEL row 3-17
- physical terminal 3-6
- power-on default 3-9
- presentation space 3-4
- print key 3-6, 6-10
- print operation 6-10
- printer assignment status indicator 5-19
- printer busy 5-11
- printer failure status indicator 5-19
- printer not working 5-10
- printer printing status indicator 5-19
- printer very busy 5-11
- program access keys 6-18
- program check 5-11
- program error codes B-5
- program function (PF) keys 6-23
- programmed symbol set 6-22
- programmed symbol set indicator
 - field-defined 5-15
 - field inherit 5-16
 - operator-selected 5-16
- programmed symbols 3-4
- programmed symbols (PS) keys 6-24
- punctuation mark keys 6-30

Q

- quadrant screen symbol 3-8
- query reply structured field 4-23
 - character sets 4-26
 - color 4-28
 - highlight 4-29
 - implicit partition 4-30
 - implicit partition default and alternate screen size 4-30
 - partitions 4-24
 - reply modes 4-27
 - self-defining parameters 4-30

R

- readiness and system connection 5-8
- ready 5-8

- reset key 6-31
- retry state 4-16
- reverse video 3-8
- reverse video key 6-25
- row and column indicator 5-20
- row spacing 3-4
- rule key 3-17, 6-19
- rule-line-does-not-follow-the-cursor 3-8
- rule-line-follows-the-cursor 3-8
- rule line function 3-18

S

- screen designations 3-6
- scroll backward key 6-19
- scroll-enabled 3-4
- scroll forward key 6-19
- security key 5-10
- security keylock 5-3
- set attribute 3-20
- set horizontal format 3-20
- setup indicator 5-8
- setup key 3-7, 6-11
- setup mode
 - description 3-5
 - setup level 1 3-7
 - setup level 2 3-7
 - setup level 3 3-11
- SNA character string capability 3-19
- SNA protocols 3-21
- spacebar key 6-31
- structured field format, activate partition 4-12
- symbol keys 6-30
- system lock indicator 5-14
- system operator indicator 5-9
- system request key 6-12

T

- tab key 6-32
- terminal wait indicator 5-12
- test indicator 5-8
- test key 6-12
- test switch 5-3
- tilt control lever 5-4
- too much entered 5-13
- transmission of buffer addresses 4-31

U

- underscore key 6-25
- uppercase shift keys 6-32
- uppercase shift lock key 6-32
- upshift indicator 5-17
- usable area 3-3

V

- validation scan 3-13
- viewport 3-4

W

- what (?) indicator 5-12
- what number indicator 5-14
- what printer status indicator 5-19
- write control characters 4-7

Z

zoom key 6-13
zoom mode 3-17

Numerals

3270 Data Stream commands 4-6
3270 Data Stream orders 4-7
3274 printer authorization matrix 3-19
3290 indicators 5-5

IBM 3290
Information Panel
Description and Reference

READER'S
COMMENT
FORM

Order No. GA23-0021-0

This manual is part of a library that serves as a reference source for systems analysts, programmers, and operators of IBM systems. This form may be used to communicate your views about this publication. They will be sent to the author's department for whatever review and action, if any, is deemed appropriate. Comments may be written in your own language; use of English is not required.

IBM may use or distribute any of the information you supply in any way it believes appropriate without incurring any obligation whatever. You may, of course, continue to use the information you supply.

Note: Copies of IBM publications are not stocked at the location to which this form is addressed. Please direct any requests for copies of publications, or for assistance in using your IBM system, to your IBM representative or to the IBM branch office serving your locality.

How did you use this publication?

- | | | | |
|--------------------------|-------------------------------------|--------------------------|------------------------|
| <input type="checkbox"/> | As an introduction | <input type="checkbox"/> | As a text (student) |
| <input type="checkbox"/> | As a reference manual | <input type="checkbox"/> | As a text (instructor) |
| <input type="checkbox"/> | For another purpose (explain) _____ | | |

Is there anything you especially like or dislike about the organization, presentation, or writing in this manual? Helpful comments include general usefulness of the book; possible additions, deletions, and clarifications; specific errors and omissions.

Page Number:

Comment:

What is your occupation? _____

Newsletter number of latest Technical Newsletter (if any) concerning this publication: _____

If you wish a reply, give your name and address:

IBM branch office serving you _____

Thank you for your cooperation. No postage stamp necessary if mailed in the U.S.A. (Elsewhere, an IBM office or representative will be happy to forward your comments or you may mail directly to the address in the Edition Notice on the back of the title page.)

Note: Staples can cause problems with automated mail sorting equipment.
Please use pressure sensitive or other gummed tape to seal this form.

Reader's Comment Form

Cut or Fold Along Line

IBM 3290 Information Panel Description and Reference (File No. S360/S370/S/4300-30) Reprinted in Japan GA23-0021-0

Fold and tape

Please Do Not Staple

Fold and tape



NO POSTAGE
NECESSARY
IF MAILED
IN THE
UNITED STATES

BUSINESS REPLY MAIL
FIRST CLASS PERMIT NO. 40 ARMONK, N.Y.

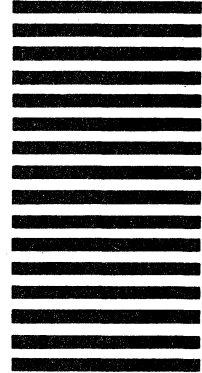

POSTAGE WILL BE PAID BY ADDRESSEE:

International Business Machines Corporation
Department 52Q
Neighborhood Road
Kingston, New York 12401

Fold and tape

Please Do Not Staple

Fold and tape



IBM