



PARADIGM[®] 512/712



Paradigm[®] 512 and 712 Infusion Pumps

Models MMT-512
MMT-712

User Guide

© 2005, Medtronic MiniMed. All rights reserved.

This product is covered by U.S. Patent Nos. 6,551,276 and 6,554,798. Other U.S. and/or foreign patents may be pending.

Bolus Wizard® is a registered trademark of Medtronic MiniMed.

Dual Wave™ is a trademark of Medtronic MiniMed.

Easy Bolus™ is a trademark of Medtronic MiniMed.

Square Wave™ is a trademark of Medtronic MiniMed.

BD Logic™ is a trademark of Becton, Dickinson and Company

Energizer® is a registered trademark of Eveready Battery Company.

Glucagon Emergency Kit® is a registered trademark of Eli Lilly and Company.

Paradigm® is a registered trademark of Medtronic MiniMed.

Paradigm Link™ is a trademark of Medtronic MiniMed.

The Link™ is a trademark of Becton, Dickinson and Company (Canada only)

Quick-serter® is a registered trademark of Medtronic MiniMed.

Quick-set® is a registered trademark of Medtronic MiniMed.

Silhouette® is a registered trademark of Medtronic MiniMed.

Sof-set® is a registered trademark of Medtronic MiniMed

U.S., international, and foreign patent applications are pending.

Rx Only



Medtronic

MINIMED

Medtronic MiniMed

Northridge, CA 91325

USA

800-646-4633 (800-MiniMed)

818-576-5555

www.minimed.com

6024914-014 081106

Important Safety Information Regarding Your Paradigm Insulin Infusion Pump (includes all models)

Avoid Immersing Your Pump In Water

Although it is unlikely that water damage will occur if your pump is splashed or briefly dunked, **you should avoid immersing your Paradigm infusion pump in water. To swim or participate in other water activities, always disconnect from your Paradigm pump and reconnect after water play.**

If you inadvertently submerge your pump in water, dry the pump quickly using a soft, clean towel and verify that it is working properly by selecting “self test” from the pump’s Utilities Menu. If you believe that water has entered your pump or you observe any other possible pump malfunction, please check your blood glucose, treat high blood glucose (if necessary) with an injection and contact our 24-Hour Help Line at 1-800-MINIMED (1-800-646-4633) for further assistance. Symptoms of high blood glucose include fatigue, excessive thirst and nausea. You should always contact your healthcare professional if you experience excessively high or low blood glucose levels, or if you have any questions about your care.

Electrostatic Discharge

Although your Paradigm pump is designed to be unaffected by typical levels of electrostatic discharge

(ESD), very high levels of ESD can result in a reset of the pump’s software with an associated pump error alarm. In most cases, exposure to high levels of ESD will trigger the pump’s E-13 alarm although, under certain circumstances, high level ESD exposure can cause E-44, Bolus Stopped or Max Delivery alarms. High levels of ESD are more likely in situations where the relative humidity is very low, such as inside a heated building during the winter in areas where it is cold outside.

If your pump experiences an E-13 or other error alarm, press the “ESC” and “ACT” buttons to clear the alarm. If you are unable to clear the alarm by pressing “ESC” and “ACT”, you may need to remove and replace the pump’s battery to clear the alarm. After clearing the alarm, you should always verify that your pump is set to the correct date and time and that all other settings (basal rate, max basal and bolus limits, etc.) are programmed to the desired values, since the software reset could erase your previously programmed settings. Please see the “Troubleshooting and alarms” section of this User Guide for more details regarding what to do if your pump displays an error alarm or other alert message.

Please contact our 24-Hour Help Line at 1-800-MINIMED (1-800-646-4633) to report any error alarms or other problems that occur with your pump.

PLEASE READ THIS ENTIRE USER GUIDE BEFORE YOU TRY TO OPERATE YOUR PUMP.

Your pump arrives from the factory in training mode so you can program your settings and practice without inserting a reservoir. The first rewind cancels training mode and installation of a reservoir will be required. Do not rewind your pump until you are ready to use it with insulin.

If you press “Rewind” by mistake, refer to **step 3, page 39**, in the section, “Rewinding your pump” for detailed instructions.

Table of contents

Glossary	xiii
Your personal information	xvii
Basal rate	xvii
Insulin type	xviii
Carb ratios (meal bolus info)	xviii
BG targets	xviii
Insulin sensitivity	xviii
Introduction	xix
Purpose	xix
How to use this guide	xx
Chapter 1 Before you begin...	1
Availability	1
Assistance	1
Emergency kit	1
Disposables	2
Accessories	2
How to wear your pump	2
Practice, practice, practice... ..	3
If you press rewind by mistake	3
Chapter 2 The basics...	5
Your pump	5

Install battery	6
Pump buttons	8
The pump screen	9
Is my pump on?	9
Scroll bar	9
Screen backlight	9
Beep/vibrate	9
HOME screen	10
Operating modes	10
Menus	11
STATUS screen	12
Alert conditions	13
What to do....	13
Low reservoir alert	13
Low battery alert	13
Alerts for special features	14
If you remove your pump...	14
Pump settings	14
Insulin	14
Chapter 3 Basic programming	15
Setting the time and date	15
BG reminder	16
Bolus	17
Normal bolus	17
from the menu, or	17
using the EXPRESS BOLUS button	17
Review your bolus deliveries	22

Bolus details	23
Maximum bolus limit	24
Basal	25
Start and stop times	25
Your basal settings	26
Basal programming and delivery	26
Basal review	28
Current basal delivery	28
Daily basal rate(s)	28
Max basal rate	30
Stopping your pump	31
Resume pump delivery	33
Chapter 4 Starting on insulin	35
Prepare your pump for use	35
Filling the reservoir	36
Changing your infusion set	38
Removing the reservoir	38
Rewinding your pump	39
Inserting the reservoir in your pump	40
Manual prime	41
Insert the infusion set	42
Quick-set infusion set (with Quick-serter®)	43
Connecting Quick-set	45
Disconnecting Quick-set	45
Fixed prime	46
Prime history	46
Record keeping for diabetes management	47
Determining your pump settings	47

Using your daily journal	48
Chapter 5 Using Bolus Wizard	49
What is it?	49
Information you need..	49
Food entry	49
Your BG reading	49
Your personal Bolus Wizard settings	49
How the Bolus Wizard works	52
More about Bolus Wizard..	52
About high or low BG levels..	52
About maximum delivery	53
About active insulin	53
How to program Bolus Wizard	54
Bolus Wizard on/off	54
Carb units	54
Carb/Exch ratios	55
BG units	56
Insulin sensitivity	56
BG targets	57
Review your Bolus Wizard settings	59
Meter option	59
Meter rules	60
Add, delete, review meter IDs	60
Normal bolus using Bolus Wizard	62
Chapter 6 Optimizing pump therapy	67
Square Wave and Dual Wave bolus	67
Dual Wave/Square Wave bolus on-off	67

Square Wave or Dual Wave bolus without Bolus Wizard	68
Using Bolus Wizard for a Square Wave or Dual Wave bolus	72
Easy bolus	74
Easy bolus setup	74
Step value setup	74
Deliver Easy Bolus	75
Basal patterns	77
Patterns on/off	77
Program a pattern	78
Select a pattern	79
Temp basal rates	81
How does temp basal work?	81
Temp basal types	81
Insulin rate	82
Percent of basal	83
Selecting temp basal type	84
Deliver a temp basal	84
Verifying temp basal delivery	85
Canceling a temp basal	85
Chapter 7 Insulin pump therapy follow-up	89
Chapter 8 Utilities	91
Alarm review	91
Alarm details	91
Setting your alert type	91
Auto-off	92
Low resv alert (Low reservoir warning)	92
Review daily insulin totals	93

Personal reminders	94
Alarm clock	94
Remote control option	94
Turn on remote control option	95
Add, delete, review remote control IDs	95
Block feature	96
Turn block on	96
Selftest	98
Clear pump	99
Select your insulin type	100
Language setting	101
Chapter 9 Troubleshooting and alarms	103
Troubleshooting	103
My pump has a no delivery alarm...	103
What happens if I leave the battery out too long?	104
Why doesn't my pump battery last very long?	104
What is a CHECK SETTINGS alarm?	104
My screen appears distorted...	104
I can't get out of the priming loop...	105
The pump is asking me to rewind...	105
My bolus stopped...	105
My pump buttons are not acting right during a bolus...	105
My pump won't display my BG reading from my meter...	106
I dropped my pump	106
I submerged my pump in water	107
Alarms	107
What to do	108

Alarm conditions	109
A (Alarm)	109
Auto off	109
Batt out limit	109
Bolus stopped	109
Button error	109
Check settings	109
E (Error)	109
Empty reservoir	109
Failed batt test	110
Is priming complete?	110
Max delivery	110
Motor error	110
No delivery	110
No reservoir	110
Off no power	110
Reset	110
Weak Battery	110
Chapter 10 Pump maintenance	111
Battery	111
Storage	111
Cleaning your pump	112
Precautions	112
Avoid extreme temperatures	112
Avoid dunking the pump in water	112
Chapter 11 User safety	113
Indications	113

Contraindications	113
Warnings	113
Reservoir and infusion sets	113
X-rays, MRIs and CT scans	113
Precautions	114
Precautions - infusion sets and sites	114
Notice	115
Insulin pump and RF accessories	115
Chapter 12 Pump specifications	117
Alarms and error messages	117
Alarm history	117
Backlight	117
Basal	117
BG target	117
Bolus delivery	118
Bolus history	118
Bolus units	118
Bolus Wizard	118
Carb ratios	118
Carb units	118
Daily totals	118
Default screen	118
Delivery accuracy	119
Drive motor	119
Dual Wave bolus	119
Easy bolus	120
Infusion pressure	120
(insulin) sensitivity	120

Insulin type	120
Low resv (reservoir) warning	120
Meter value	120
Normal bolus	121
Occlusion detection	121
Percent temp basal	121
Power supply	121
Prime function	121
Prime history	121
Program safety checks	121
Pump size	122
Pump weight	122
Remote control	122
Reservoir	122
Square Wave bolus	122
Status screen	123
Temporary (temp) basal rate	124
Time and date screen	124
Water tight	124
Bolus Wizard specifications	125
Default settings	128
Icon table	129
.....	129
Index	131
Menu map	135

Practice lessons and examples

Bolus examples

Meal bolus

Example #1 Normal meal bolus using the exchange system	18
Bolus practice:	18
Normal meal bolus practice using exchanges:	18
Example #2: Normal meal bolus using carbohydrate counting	19
Normal meal bolus practice using carbohydrate counting:	19

Correction bolus

Example #3: Meal bolus, correction bolus and insulin sensitivity	20
Practice: Meal bolus	21

Max bolus

Example #1: Max bolus	24
Example #2: Max bolus	24

Basal examples

Basal programming

Practice: Basal programming	27
-----------------------------------	----

Max basal

Example #1: Max Basal	30
Example #2: Max Basal	30

Suspend/Resume examples

Example: Suspend function	32
Practice: Suspend function	32
Practice: Resume basal delivery after a suspend	33

Bolus Wizard examples

Example #1: Bolus Wizard, BG on target (normal BG)	64
Example #2: Bolus Wizard, BG above target (high BG)	64
Example #3: Bolus Wizard, Blood glucose below target (low BG)	65
Example #4: Bolus Wizard, Blood glucose above target (high BG) with active insulin	65

Square Wave bolus examples

Example #1: Square Wave bolus, Use of a Square Wave bolus while eating a meal high in fat	69
Example #2: Square Wave bolus, (gastroparesis)	69
Your turn: Square Wave bolus practice	69

Dual Wave bolus examples

Example #1: Dual Wave bolus Set a Dual Wave bolus for a barbecue style dinner	70
Example #2: Dual Wave bolus, Set a Dual Wave bolus for correcting elevated BG before a meal	70
Your turn: Dual Wave bolus practice	71

Easy bolus examples

Example #1: Easy bolus	76
Your turn: Easy bolus practice	76

Basal patterns examples

Example #1: Basal patterns	80
Example #2: Basal patterns	80
Your turn:	80

Temp Basal examples

Example #1: Temp Basal for a decreased temporary basal rate	86
Example #2: Temp Basal for an increased temporary basal rate	86
Your turn:	87

Block examples

Example #1: Block	97
Example #2: Block	97

Glossary

A

Accept - Pressing the **ACT** button to approve the selection or setting.

Active Insulin - Bolus insulin that has been delivered to your body, but has not yet been used.

Alarm - Audible or vibrating (silent) notice that indicates the pump is in Attention mode and immediate attention is required. Alarms are prefixed in the alarm history with the letter A.

Alarm clock - Feature you can set to go off at specified times of the day.

ALARM HISTORY - Screen that displays the last twelve alarms/errors that have occurred on your pump.

Alert - Audible or vibrating (silent) indicator that notifies you the pump needs attention soon or that you should be reminded of something. Insulin delivery continues as programmed.

Attention mode - Operating mode that stops all current insulin delivery. This mode indicates an alarm or condition exists that requires immediate attention.

B

Backlight - Pump screen light. Turns on whenever the down  button is pressed from the HOME screen, or during an alarm (except LOW BATT).

Basal Rate - The pump setting that provides a continuous infusion of insulin to keep the blood glucose stable between meals and during the night. Basal insulin mimics pancreatic insulin delivery --

which meets all the body's non-food related insulin needs.

BASAL REVIEW screen - shows the basal rates programmed in the pump, with the 24-hour total for each rate.

BG - Blood Glucose

BG reminder - Feature that you can set to remind you to check your blood glucose after a bolus.

BG target - normal blood glucose level

BG unit - blood glucose unit of measure (mg/dl or mmol/L)

Block - Feature that restricts access to all programming except suspend, selftest and the delivery of a bolus with the remote control.

Bolus - A dose of insulin given to cover an expected rise in blood glucose (such as the rise after a meal) or to lower a high blood glucose down to target range.

BOLUS HISTORY - This screen displays the last twenty-four (24) boluses delivered by your pump.

Bolus Wizard™ - Feature that calculates the bolus amount based on personal information of the pump user.

C

Carb ratio - (Carbohydrate ratio)
Used when counting carbohydrates in grams. The amount of carbohydrates covered by one unit of insulin. (Also see exch ratio.)

Carb units - The food entry when using the Bolus Wizard. Entered as (carbohydrate) grams or exchanges.

CH - Carbohydrate

Correction bolus - The amount of insulin needed to return a high blood glucose level back down to target range.

Correction bolus factor - How much 1.0 unit of insulin will lower your blood glucose. This factor is used to calculate a correction bolus amount when your blood sugar is high.

$$(BG \text{ level}) - (BG \text{ target}) = X.$$

$$X \div (\text{corr bolus factor}) = \text{corr bolus amount}$$

D

Daily totals - Shows the total insulin delivered (basal and bolus) in the last 24-hours.

Maximum records: 14 days

DKA - Diabetic Ketoacidosis

Dual Wave™ bolus - Combination of a Normal bolus that is delivered immediately, then followed by a Square Wave bolus. The Square Wave portion is delivered evenly over a period of time.

Duration - Amount of time it takes to administer a bolus or basal delivery. Also, length of time for an action or condition.

E

Easy bolus™ - Method of delivery for a Normal bolus that using the Easy Bolus button .

Exch ratio - (Exchange ratio)
Used when counting carbohydrates as exchanges. The amount of insulin required to cover one (1) carbohydrate exchange. (Also see carb ratio.)

Express bolus - Method of delivery for any bolus type using the express bolus button .

F

Fixed prime - Fills the cannula with insulin. This is done after you insert the infusion set into your body and remove the introducer needle.

Food bolus - A dose of insulin given to cover the expected rise in blood glucose that occurs after eating.

G

Gastroparesis - A condition of the digestive system that slows down the emptying of food from the stomach.

H

HbA1c - Glycosylated hemoglobin

HDL - high-density lipoprotein

A complex of lipids and proteins in approximately equal amounts that functions as a transporter of cholesterol in the blood.

Hold - Press and continue to press a pump button.

I

Idle - The pump is at the HOME screen.

Ins sensitivity - The amount that your blood glucose (BG) level is reduced by one unit of insulin. (Bolus Wizard data)

Insulin type - Type of insulin used: U100 fast acting or U100 regular.

L

LDL - low-density lipoprotein

A complex of lipids and proteins, with greater amounts of lipid than protein, that transports cholesterol in the blood.

Link - To turn on and setup the meter option that allows the pump to receive BG readings from the Paradigm Link meter.

Low resv warning - Programmable warning that notifies you with an alert when either a specified number of units remain in the reservoir or a specified amount of time remains before the reservoir will be empty.

M

Manual bolus - Selectable item available in the BOLUS MENU when Bolus Wizard is active. One method of programming a bolus without Bolus Wizard. (see "Set bolus")

Manual prime - Fills the infusion set tubing with insulin before you insert the set into your body. (This function is available after a rewind)

Max bolus - The maximum amount of bolus insulin that the pump will deliver at one time. (set by the user)

Max basal rate - The maximum amount of basal insulin that the pump will deliver at one time. (set by the user)

Meter - The Paradigm Link Blood Glucose Monitor Powered by BD Logic™ Technology (Paradigm Link meter). Your pump can be programmed to receive your BG readings from this meter.

Meter option - Feature that allows the pump to receive BG readings from the Paradigm Link meter.

N

Normal mode - Regular operating mode. No special features are active, no alert or alarm conditions exist. Insulin delivery is normal during this mode.

Normal bolus - An immediate delivery of a specified unit amount of insulin.

Now - The "Normal" portion of a Dual Wave bolus. The now portion delivers immediately and is then followed by the Square portion.

P

Pattern feature - Extended pump feature that allows you to program optional basals (Pattern A, Pattern B) that support activities that are not a part of your day-to-day routine, but are usual in your lifestyle. Such activities could be a sport that you do once a week or a change in your sleep pattern over the weekend.

Pattern, standard - Your normal basal that supports your usual day-to-day activity. When the Patterns feature is off, the pump uses your standard (basal) pattern.

Press - To push and release a button.

Prime - (see fixed prime or manual prime)

PSI - Pound-force per square inch

R

Resume - Restarts basal delivery after the pump is suspended.

Rewind - The pump drive moves back to its starting position to prepare the pump for a new reservoir.

RF - Radio frequency

S

Scroll - Press the up or down arrow buttons to move through the screen text.

Select - Pressing the up or down arrow buttons to highlight a desired screen item.

Set bolus - Selectable item available in the BOLUS MENU when Bolus Wizard is inactive. One method of programming a bolus without Bolus Wizard. (see "Manual bolus")

Special mode - Operating mode that indicates one or more special functions is active or a condition exists that requires attention.

Square Wave™ bolus - Immediate bolus delivered evenly over a specified time period (30 minutes to 8 hours).

Square Wave portion - (Sq) The second part of a Dual Wave bolus. The Square Wave portion delivers evenly over a period of time after the NOW portion delivers.

Status screen - Displays the current operations of the pump, including active functions, the most recent basal and bolus deliveries, reservoir information, and battery condition.

Step - Measurement of insulin that you set and use for Easy Bolus delivery.

Suspend - Function that stops all insulin delivery. Any current bolus and/or prime deliveries are canceled. The basal delivery is paused until restarted.

T

Temp - Temporary

Temp basal - (Tmp basal) Temporary one-time basal insulin with a specified amount and duration. Used to support insulin needs for special activities or conditions that are not part of the normal daily routine.

Training mode - Mode of your pump when it is shipped to you. The pump arrives in this mode so you do not have to install a reservoir to practice. Once training mode is canceled, a reservoir is required.

U

μL - microliter

Your personal information

You may need the following information from your healthcare professional before going to your pump start appointment. If you are unsure, contact your healthcare professional or pump trainer for instructions.

NOTE - This information is not for the Bolus Wizard. Refer to chapter 5 for Bolus Wizard settings.

Basal rate

Basal insulin is required to maintain your target glucose values when you are not eating. Your pump can be programmed with up to three (3) basal patterns (standard, pattern A, pattern B) to accommodate your varying insulin needs on different days (example: weekday versus weekend day). Each pattern can have up to 48 basal rates. When you first start pump therapy, you may only have to program one or two basal rates. Get your basal rate settings from your healthcare professional.

Pattern A

Basal rate number	Start time	Basal rate (units per hour)
#1	midnight	
#2		
#3		
(additional basal rates)		
#4		
#5		
#6		
#7		
#8		

Standard

Basal rate number	Start time	Basal rate (units per hour)
#1	midnight	
#2		
#3		
(additional basal rates)		
#4		
#5		
#6		
#7		
#8		

Pattern B

Basal rate number	Start time	Basal rate (units per hour)
#1	midnight	
#2		
#3		
(additional basal rates)		
#4		
#5		
#6		
#7		
#8		

Insulin type

Your pump is sent from the factory with the insulin type set to U100 fast acting. The insulin type can also be set to U100 regular acting.

My insulin type is: _____ U100 fast acting
_____ U100 regular acting

Carb ratios (meal bolus info)

Your carb ratios are used to calculate your meal boluses.

If you count grams: this ratio is the number of carb grams covered by one (1) unit of insulin.

If you count exchanges: this ratio is the number of insulin units you need to cover one carb exchange.

When	(grams/u or u/exch)
breakfast	
lunch	
dinner	
snacks	

BG targets

BG targets are the levels that your BG (blood glucose) should be and are required for pump therapy. Keeping your BG within target range is important for living well with diabetes. Your healthcare professional should help you determine these targets.

When	BG Target (mg/dL or mmol/L)
before meals:	
2 hours after meals:	
bedtime:	
before driving:	

Insulin sensitivity

Your insulin sensitivity value indicates how much your blood glucose is reduced by 1 unit of insulin. Your insulin sensitivity values are used to calculate your correction boluses for high BG.

1 unit of insulin will lower my BG:

_____ mg/dL or _____ mmol/L

Thank you for choosing Medtronic MiniMed as your partner in helping you gain better control of your diabetes. Whether you are beginning pump therapy for the first time or upgrading from a previous model, we believe that the combination of state-of-the-art technology and the simple, menu-driven programming of the pump will provide many benefits.

Purpose





This user guide is designed to help you to understand pump therapy and the operation of your pump. We strongly recommend that you work closely with your healthcare professional for a safe and complete pump start.

Your pump is for insulin therapy to help you maintain a stable blood glucose target throughout the day. Based on your settings, the pump delivers your custom basal automatically and continuously 24-hours a day. It also provides bolus deliveries to support your immediate insulin needs for food intake and/or high blood glucose. The Bolus Wizard feature can calculate your bolus amount for you based on your personal settings.

How to use this guide

NOTE - This user guide shows sample screens only. The screens in this user guide may be slightly different than your actual pump screens.

For step-by-step instructions, refer to the applicable sections in this guide. Refer to the Glossary for definitions of terms and functions. The terms and symbols used in the step-by-step instructions are in the table below.

Term / symbol	Meaning
"Press"	to push and release the button
"Hold"	to push and keep pressure on the button
"Select"	to press  /  to highlight a screen item you want to select
"Exit the menus"	Press ESC until the HOME screen appears
Pump Buttons	always bold and uppercase; for example, ESC, ACT
Screen and menu names	always uppercase; for example, MAIN MENU, REWIND screen
Menu selections	always bold; for example, 12-Hour Setup, On, Off
flashing (blinking) screen item	you can change the value for that item with the  /  buttons
NOTE- and TIP -	additional helpful information for the preceding text
CAUTION:	warns of a potential hazard which, if not avoided, may result in minor or moderate injury to the equipment
WARNING:	notifies you of a potential hazard which, if not avoided, could result in death or serious injury. It may also describe potential serious adverse reactions and safety hazards
"Go to the...screen."	when a step instructs you to "Go to" a screen, the path to that screen is shown. For example: <p style="text-align: center;">Go to the ALARM MENU. Main > Utilities > Alarm</p> <ol style="list-style-type: none">1. From the MAIN MENU, select Utilities and press ACT.2. In the UTILITIES MENU, select Alarm and press ACT.3. The ALARM MENU appears.

Availability

The pump and accompanying products are available from Medtronic MiniMed and authorized distributors.

Assistance

Medtronic MiniMed provides a 24-hour Product Help Line for assistance. The Help Line is staffed with technicians who are trained in the set-up and operation of the pump and are able to answer pump-related questions. When calling the Help Line or your local Medtronic MiniMed office, please have your pump and serial number available. The phone number for the 24-hour Product Help Line is also on the back of your pump.

Department	Telephone number
24-hour Product Help Line (calls within the United States)	800.646.4633 (800.Minimed)
24-hour Product Help Line (calls outside the United States)	818.576.5555
Web site	www.minimed.com

Emergency kit

Keep an emergency kit with you at all times to make sure that you always have necessary supplies. Inform a family member, co-worker, and/or friend where this emergency kit is kept. Please refer to chapter 11, "User safety" for more information on pump safety. Your emergency kit should include these items:

- ➡ Fast-acting glucose tablets
- ➡ Blood glucose monitoring supplies
- ➡ Urine ketone monitoring supplies
- ➡ Extra Paradigm infusion set and Paradigm reservoir
- ➡ Insulin syringe and fast-acting insulin (with dosage instructions from your healthcare professional)
- ➡ Paradigm Quick Reference Card
- ➡ Dressing and adhesive
- ➡ Glucagon Emergency Kit®
- ➡ Extra AAA Alkaline batteries (Energizer® brand is recommended)

Disposables

The pumps use disposable reservoirs and infusion sets for insulin delivery. Installation instructions for Paradigm reservoir and infusion sets are provided in chapter 4.

- ➔ **Reservoirs:** The 512 pump is intended for use with a 180-unit Paradigm reservoir (MMT-326). The 712 pump is intended for use with a 300-unit Paradigm reservoir (MMT-332), however it can also use the smaller 180-unit reservoir as well.
- ➔ **Infusion sets:** Medtronic MiniMed provides a variety of Paradigm infusion sets to fit your needs.

WARNING: For your protection the pump has undergone extensive testing to confirm appropriate operation when used with Paradigm reservoirs and Paradigm infusion sets manufactured or distributed by Medtronic MiniMed. We recommend using Medtronic MiniMed infusion sets and reservoirs as we cannot guarantee appropriate operation if the pump is used with reservoirs or infusion sets offered by third-parties and therefore we are not responsible for any injury or malfunctioning of the pump that may occur in association with such use.

Accessories

- ➔ **Meter:** Your pump can be used with the optional Paradigm Link™ Blood Glucose Monitor powered by BD Logic™ Technology. You can program your pump to automatically receive your BG reading from this meter.
- ➔ **Remote control:** The optional Paradigm remote control can be used with the pump to deliver normal boluses and suspend the pump from a distant location. (This User Guide provides programming instructions for the remote control. Refer to the remote control User Guide for operating instructions.)

To order supplies, call
800-646-4633 (1-800-MiniMed)
818-362-5958 (outside U.S.)
www.minimed.com

How to wear your pump

There are a different ways to wear your pump. Medtronic MiniMed has accessories that can hide, protect, and add to the convenience of wearing a pump. Refer to the accessories catalog or the website (www.minimed.com) for more information.

- ➔ **Holster:** to wear the pump on your belt.
- ➔ **Pump clip:** to wear the pump underneath your clothing.
- ➔ **Activity guard:** If you are active in sports, or you are a child, use the guard to protect the pump from disconnecting.

Practice, practice, practice...

Before you begin pump therapy, it is important that you become familiar with your pump.

Do

- ➡ Read Book 1, “Introduction to Pump Therapy”
- ➡ Watch the instructional video
- ➡ Read this book
- ➡ Complete the practice exercises in this book (Refer to the table of contents for a list of practice exercises.)
- ➡ Explore and navigate the pump menus
- ➡ Practice programming a bolus
- ➡ Practice programming a basal rate
- ➡ Practice using the Medtronic MiniMed Pump school online at <http://pumpschool.minimed.com>

Do NOT

- ➡ DO NOT install a reservoir into the pump while you are practicing
- ➡ DO NOT, under any circumstances, begin insulin therapy without guidance from your healthcare professional

If you press rewind by mistake

Your pump arrives from the factory in training mode so you can program your pump and practice without inserting a reservoir. The first “Rewind” cancels training mode.

Rewind is part of the process that takes place with every infusion set change. You will learn about this in Chapter 4, “Starting on insulin” and at your pump training.

If you press “Rewind” by mistake, do NOT insert the reservoir in your pump. Insert the red shipping cap into your pump and follow the prompts. Your settings will be retained. Refer to step 3, page 39 in the section “Rewinding you pump” for detailed instructions.

Remember,
do NOT use a reservoir with insulin until you have been instructed to do so by your healthcare professional.

Your pump

CAUTION: Never use sharp objects to press the buttons on your Paradigm pump as this can damage the buttons or compromise the seal of the pump. Some examples of sharp objects that may damage your keypad are fingernail files, pens or pencils, paperclips, knives, scissors, and keys.

Take a look at your pump. The reservoir window allows you to view the insulin in the reservoir. The reservoir, with the tubing connector attached, is inserted into the reservoir compartment of the pump.

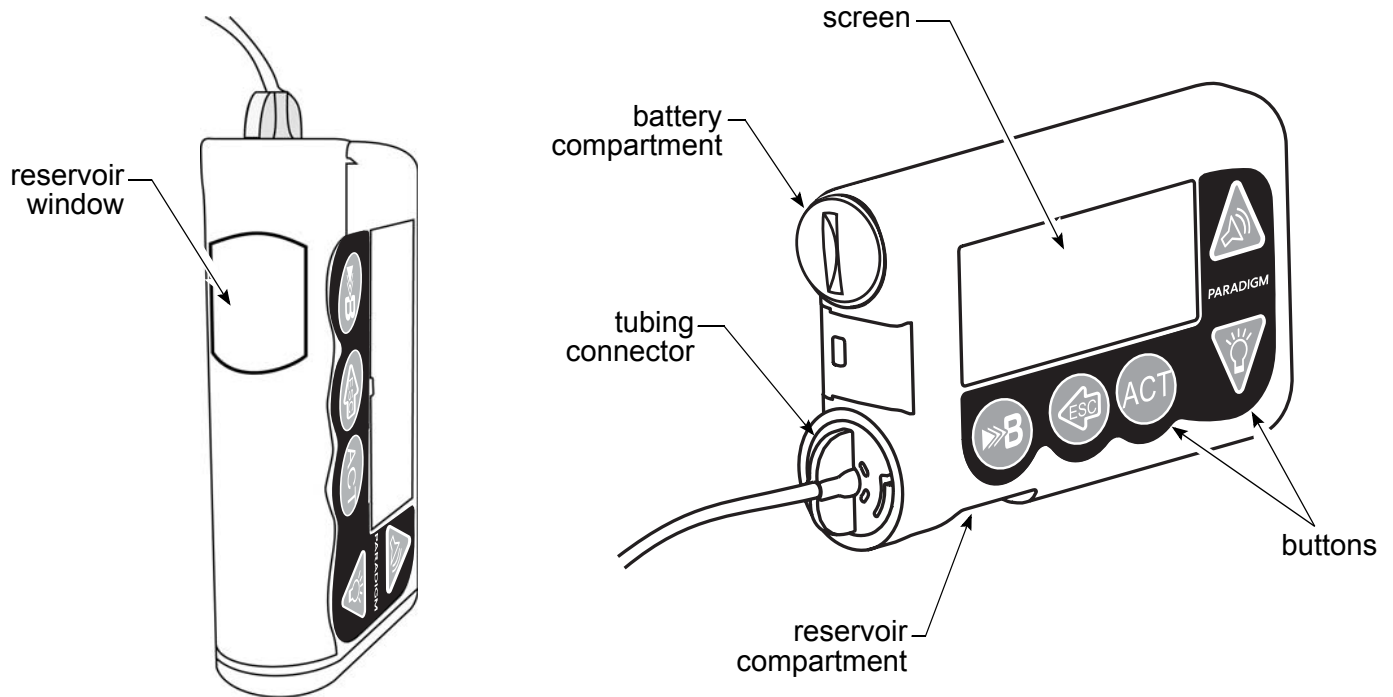

**512 pump shown;
712 pump similar**

Install battery

CAUTION: Do not use a rechargeable or carbon zinc battery in your pump. A new AAA Alkaline Energizer battery is strongly recommended. The use of any other battery type may not offer the same battery performance.

Medtronic MiniMed designed the pump to only accept a NEW battery. As a safety measure, if you install a battery that does not have full power, the “failed batt test” alarm will sound. The pump uses one AAA alkaline battery.

1. Make sure all the following apply:
 - Clear (**ESC, ACT**) any alarms and/or alerts before removing and replacing the battery
 - Make sure the pump is at the HOME (idle) screen when you remove the battery.
 - Do NOT remove the battery during a bolus or prime delivery.
2. Use the edge of a quarter to remove the battery cap. Turn the cap in a counter-clockwise direction.
3. Remove the old battery. Put the new battery in the pump with the negative end [(-) symbol] going in first. Check the label on the back of the pump to make sure the battery is inserted correctly.

NOTE - Do not use batteries that have been in cold storage (i.e., in the refrigerator or your car in the winter).

4. Place the battery cap on the pump so that the slot is aligned in the orientation shown here:

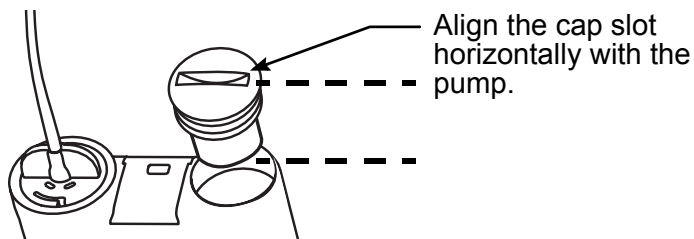

5. Turn the battery cap clockwise 4 half-turns so the slot is aligned horizontally with the pump as shown here:

Do NOT apply force when you turn the cap.

CAUTION: Do NOT over-tighten the battery cap. You should not turn the cap more than four (4) half-turns. If you over-tighten the cap you may not be able to remove it, and you can damage your pump.

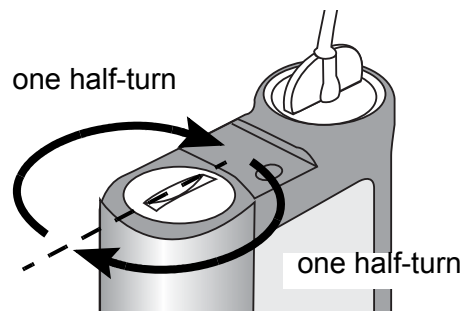

6. While the pump turns on, it will show various screens until the HOME screen appears.

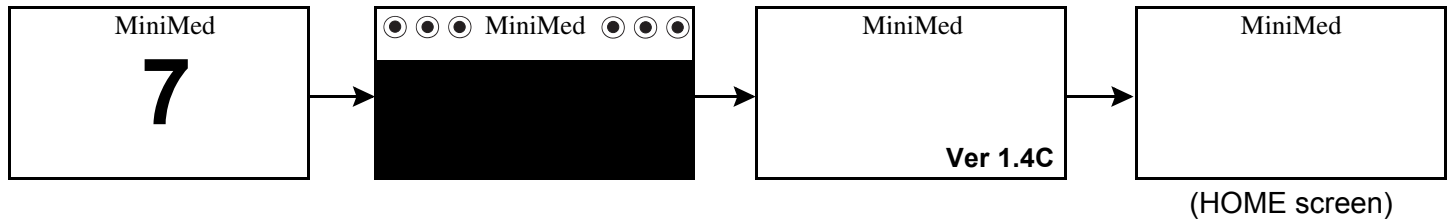

If the HOME screen does not appear, do these steps:

- a. Check that the battery is inserted correctly. If the battery has been installed backwards, remove the battery and install a NEW battery.
 - b. If your pump still does not turn on or you get a FAILED BATT TEST alarm, remove and replace the battery with a new one.
 - c. If the pump is still not on, call the Medtronic MiniMed 24-hour Product Help Line.
7. Check to make sure the time and date are correct. If this is the first battery installed, or if more than 5 minutes have passed since you removed the battery, you must program the time and date. Refer to the section, "Setting the time and date" in chapter 3 for programming instructions.
8. Press **ESC** to view the STATUS screen, making sure no alarms are active. If an alarm is active, follow the instructions on the screen.

Pump buttons

The buttons on the pump are used to navigate through the menus and screens, and to program the features of the pump.

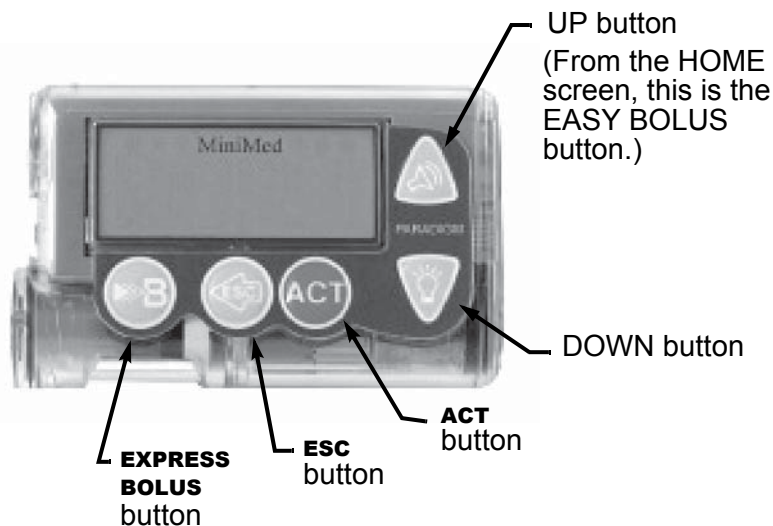

512 pump shown;
712 pump similar

From the HOME screen...



(Easy Bolus button)

Shortcut to set and deliver an Easy Bolus.



Turns the backlight on/off.



Opens the MAIN MENU.



(express bolus button) Short-cut to the BOLUS MENU to setup any bolus type.



Opens the STATUS screen.

From the menus and programming screens...



Increases / decreases the value of a flashing item.



Scrolls up and down the items in a list.



Accepts a selected menu item or activates a selected setting.



Returns the screen to the previous screen.
Backs out of an unintentional menu selection if the **ACT** button has not been pressed yet.

The pump screen

The screen shows five lines of text at one time. The first is the operating mode. The second is the current open menu or function. The last three lines show either information or text that you can select for the current function.

NOTE - The screen text in the examples used in this guide might not exactly match the text on your pump screen. Please follow your pump screen instructions. If you have any questions, call the Medtronic MiniMed 24-hour Product Help Line.

Is my pump on?

When the pump is on, the word “MiniMed” always appears across the top of the screen. If “MiniMed” does not appear, the pump is not operating.

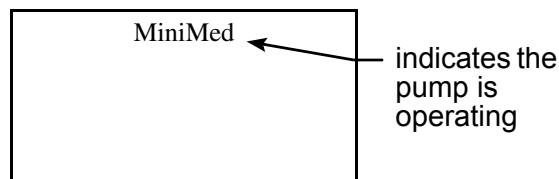

Scroll bar

If there is more text than the screen can show, a scroll bar appears in the right side of the screen. Press  to view any additional text.

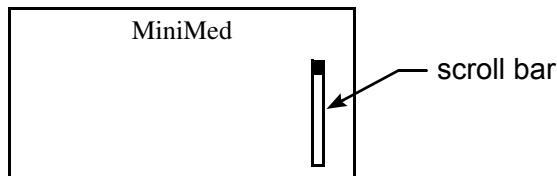

Screen backlight

When you press  from the HOME screen, the light on the screen turns on or off. During programming, the light will stay on while you are pressing any of the pump buttons. It will turn off automatically 30 seconds after the last button is pressed.

To conserve your battery, the backlight will turn off automatically while the pump is vibrating. After the vibration is finished, the light will turn back on.

Beep/vibrate

Your pump will beep or vibrate to indicate activity. Refer to the section, “Setting your alert type” in chapter 8 for setup instructions.

HOME screen

The HOME screen serves as the starting point to access the programming screens. When no buttons are pressed for about 30 seconds, the pump returns to this screen.

When you press **ACT** from the HOME screen, the MAIN MENU will appear.

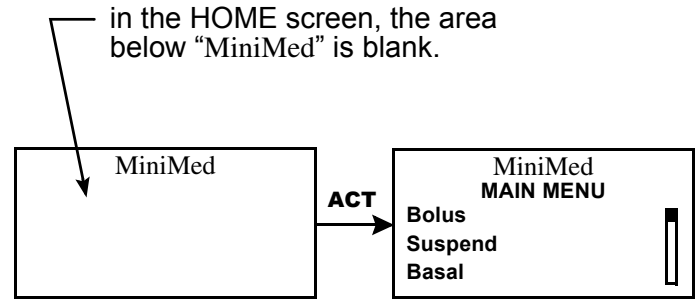

Operating modes

The screen lets you know when a special feature is active or if there is a condition that needs your attention. The active features and pump status will determine the operating mode. The screens for the three modes are shown below.

Normal - mode for standard pump operations for normal basal and bolus delivery. No special features are active (i.e., basal patterns, temp basal, etc.). No alarms and no alerts exist.

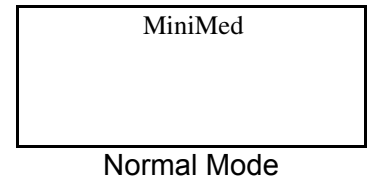

Special - indicates a special feature is active or an alert condition(s) exists. Special mode does not restrict any of the pump functions. When the pump is in Special mode, open circles appear across the top of the screen and it will beep/vibrate periodically to remind you of the condition. The conditions and features that will put the pump in Special mode are:



- ➡ Low Reservoir condition
- ➡ Low Battery condition
- ➡ Block feature is on
- ➡ Dual or Square Wave bolus delivery
- ➡ Basal pattern A or B is active
- ➡ Temporary basal delivery

Attention - indicates insulin delivery has stopped. Either an alarm is active or an alarm condition exists that needs immediate attention for insulin delivery to resume. Solid circles appear across the top of the screen and the pump will beep periodically until the condition is cleared. The screen will show text describing the condition that

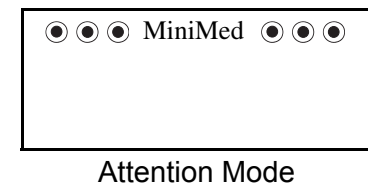



put the pump in Attention mode. For example, if the reservoir is empty, "Empty Reservoir" will appear on the screen.

When the pump is in Attention mode, it will beep/vibrate periodically to remind you of the condition. The beep/vibrate frequency varies depending on the condition that caused the alarm. Refer to the section, "Alarm conditions" in chapter 9 for the conditions that will trigger the Attention mode.

When the pump is in "Attention mode," all insulin deliveries are stopped.

Menus

The MAIN MENU is the highest level menu. There are submenus, functions, status and programming screens in the lower menu levels. The menus are described in the following paragraphs. A diagram of the menu structure is at the back of this user guide.

***TIP** - If a screen item is flashing (blinking), during programming, press  /  to change the value.*

MAIN MENU - Highest menu level in the menu system. When you press **ACT** from the HOME screen, the MAIN MENU will appear.

BOLUS MENU - Contains the settings and function for bolus deliveries. The  button allows direct access to the BOLUS MENU without having to navigate through the menus.

SUSPEND - Stops all current insulin deliveries (basal, bolus and fixed prime). Refer to section, "Stopping your pump" in chapter 3 for more information.

BASAL MENU - Contains the functions to setup and deliver your basal. Refer to the section, "Basal" in chapter 3 for more information.

PRIME MENU - Contains the functions required to change your reservoir and fill the infusion set with insulin. Refer to the section, "Changing your infusion set" in chapter 4 for more information.

UTILITIES MENU - Contains features for your safety and convenience. Refer to chapter 8, "Utilities" for more information.

STATUS screen

The STATUS screen shows information about what your pump is doing. The information that shows on the STATUS screen depends on the current activities and conditions of your pump. The screen includes information about:

- recent insulin deliveries (basal and bolus)
- reservoir status
- time and date
- special features that are turned on
- battery status
- insulin type

Refer to chapter 12, "Specifications" for a complete list of the information that is available in the STATUS screen.

- To open the STATUS screen..... Press **ESC** until the STATUS screen appears.
- To view more text on the STATUS screen..... Press  /  to scroll and view all of the information.
- To exit the STATUS screen Press **ESC** until the STATUS screen disappears.

NOTE - *Only check your pump status (press **ESC**) when you are not programming your pump. If you press **ESC** during programming, you will cancel the settings you are trying to enter.*

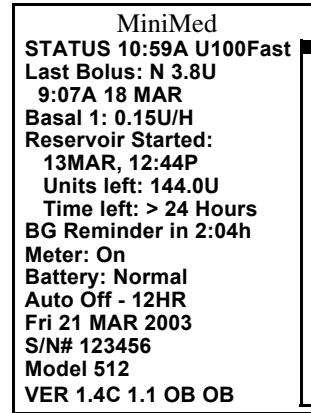

Sample
STATUS screen

Alert conditions

Your pump has a sophisticated network of safety checks and systems. If it detects an unusual condition that requires your immediate attention, it will beep or vibrate periodically to alert you. The pump will go into Special mode (open circles will display), and the backlight will illuminate. Additionally, the alert message will appear on the screen.

► Why are alerts important?

Your pump monitors activities and will alert you if a Special mode is active. Some alerts are a normal part of pump therapy, such as an active temporary basal. There are alerts that indicate a condition that is outside normal pump activity. For example, your pump notifies you with an alert when you need to replace the reservoir (LOW RESERVOIR) or replace your pump battery (LOW BATTERY).

What to do....

When your pump beeps or vibrates notifying you that an alert condition exists:

1. Read and follow the instructions on the screen. Press **ESC, ACT** to silence an alert.
2. Check the STATUS screen to determine what caused the alert.
3. If the condition is due to a low battery, replace the battery.
4. If the condition is due to a low reservoir, monitor the reservoir volume frequently and change the reservoir when appropriate. Make sure you have a new reservoir, infusion set and vial of insulin with you.

Low reservoir alert

You can program the pump to sound an alert when either a specified number of units remains or a specified amount of time remains before the reservoir will be empty.



Low battery alert

If you get this alert, DO NOT go to sleep without replacing the battery. The backlight and the remote and Paradigm Link meter functions are disabled during a LOW BATTERY condition. If the alert type is set to "vibrate," the pump will change to the audio alert "beep-medium." Clear (**ESC, ACT**) this alert before you replace your battery.

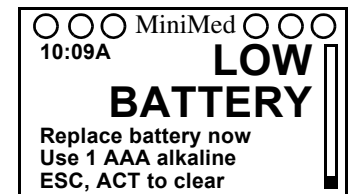

Alerts for special features

Some features put the pump in Special mode, letting you know that an extended feature is active. When the feature is no longer active, the pump will return to Normal mode. Your pump will alert you (with open circles) if any of these extended features are active:



- ➡ Dual Wave or Square Wave bolus delivery
- ➡ Temp basal delivery
- ➡ Pattern A or B is active
- ➡ Block feature is on

If you remove your pump...

Pump settings

You may have an occasion when you need or want to remove your pump. If you have to remove and store your pump, it is recommended that you store it with the battery in place. Keep a record of your current basal rates. To preserve battery life, reset the basal rates to 0 (zero), turn off the RF options (meter, remote), and set Auto-off to dashes or zeroes.

NOTE - *Your pump keeps a record of the basal and bolus insulin it delivers. Setting your basal to 0.0 while you are disconnected ensures the insulin delivery records in your pump are accurate.*

Insulin

Remember, your body still needs insulin while your pump is removed.



You can remove your pump for up to one (1) hour without taking insulin. If you remove your pump for more than an hour, you will have to use another way to take your insulin, such as injections of fast-acting insulin, or reconnecting your pump to take boluses. Take the injection or bolus approximately every four (4) hours. Calculate the amount of insulin to take based on the total of your basal insulin in four (4) hours. Include the amount you need for meal and correction boluses. If you will have your pump off for several days, you will need to return to a multiple injection regimen. It is important that you consult with your healthcare professional to determine an alternate method of receiving your insulin.

Setting the time and date

Setting the correct time and date in your pump is necessary for accurate basal insulin delivery and allows you to keep an accurate record of your insulin delivery and other pump functions. You can select a 12-hour or 24-hour clock. You must reset the time and date if you receive a CHECK SETTINGS alarm or you clear your pump (Clear Pump function).

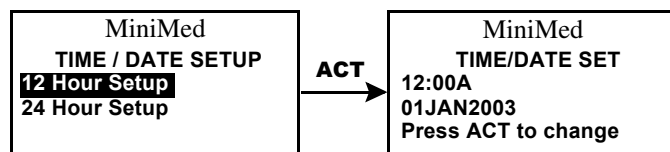
1. Go to the TIME/DATE SETUP screen.
Main > Utilities > Time/Date
2. Select 12-Hour Setup or 24-Hour Setup and press **ACT**.
3. Press **ACT** again to change the settings.
4. Change each of the settings as follows:



Hour	Minutes	Year	Month	Day
<div style="border: 1px solid black; padding: 5px;"> MiniMed SET HOUR 12:00A </div> <p>Change the hour. Press ACT.</p> <p>For 12-hour setups, press  /  until the correct A (am) or P (pm) appears.</p>	<div style="border: 1px solid black; padding: 5px;"> MiniMed SET MINUTES 9:00A </div> <p>Change the minutes. Press ACT.</p>	<div style="border: 1px solid black; padding: 5px;"> MiniMed SET YEAR 2003 </div> <p>Change the year. Press ACT.</p>	<div style="border: 1px solid black; padding: 5px;"> MiniMed SET MONTH 01 </div> <p>Change the month. Press ACT.</p>	<div style="border: 1px solid black; padding: 5px;"> MiniMed SET DAY 01 </div> <p>Change the day. Press ACT.</p>

- The TIME SET AT screen will show the settings that you programmed. Press **ACT** and exit the menus.

Your time/date settings are complete.



After a “clear pump” function only:

The TIME DATE CORRECT? screen will appear after you set the DAY. Select **Yes** to confirm the settings and press **ACT**. Your time/date settings are complete. You must now rewind your pump as described in the section, “Rewinding your pump” in chapter 4.

BG reminder

When you deliver a bolus you may want to check your BG afterwards. The BG reminder is an optional feature that beeps or vibrates to remind you to check your blood glucose after a bolus. Your pump is set at the factory with this feature turned off. If the BG reminder is on, during bolus programming your pump will ask for the amount of time you want to be reminded after your bolus delivers. This time can be from 30 minutes to 5 hours, or NONE. If you do not want to use the BG Reminder at all, set the option to **off**. (*BG Reminder is not available after an Easy Bolus.*)

- Go to the BG REMINDER SETUP screen.
Main > Bolus > BG Reminder
- Select **On** and press **ACT**. The BG reminder is now enabled. Exit the menus.



Now, the next time you program a bolus, your pump will ask you for the amount of time after your bolus when you want to be reminded to check your BG.



NOTE - *If you press **ESC** when the BG Reminder Duration screen appears, your pump will begin delivering the bolus without setting a reminder. If you program another bolus with a BG reminder before a previously scheduled BG reminder goes off, the previous BG reminder will be canceled.*

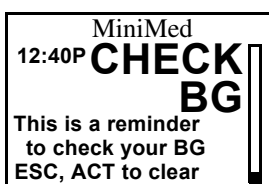

When the BG reminder goes off, your pump will beep or vibrate and the message “CHECK BG” will appear on the screen. Your pump will beep or vibrate periodically until it is cleared (**ESC, ACT**).

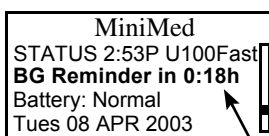

When you set a BG reminder after a bolus, the STATUS screen will show the amount of time remaining before the reminder will go off.

Here, the STATUS screen indicates BG reminder will go off in 18 minutes.

Bolus

There are three bolus types: Normal, Square Wave, and Dual Wave. This section gives instructions for a Normal bolus using the express bolus button and navigating through the menus. (For information about Square Wave and Dual Wave boluses, refer to chapter 6, "Optimizing pump therapy.")

The Normal bolus delivers an immediate food or correction bolus. It can be delivered at any time except during another Normal bolus. During a Normal bolus, most pump features are disabled until after all the bolus has been delivered. The suspend function and the STATUS screen, however, are always available.

Normal bolus

Normal bolus can be used to cover the carbohydrate in a meal or snack and/or to correct a blood glucose that is higher than the target that was chosen for you.

The following instructions are for a Normal bolus without the Bolus Wizard.

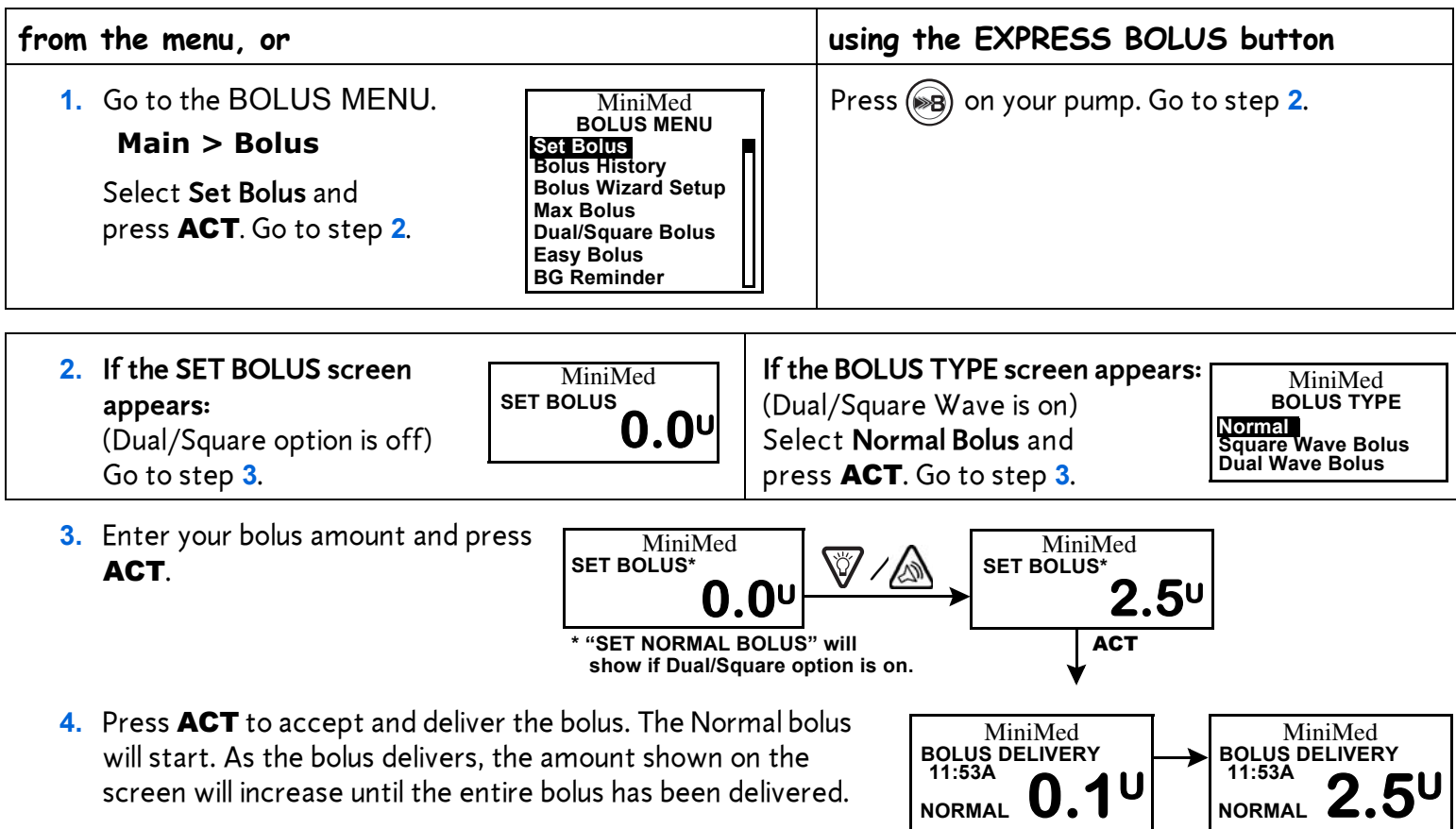

NOTE - The pump will beep/vibrate at the start of the bolus.
When the bolus is finished, the pump will beep/vibrate again
and the HOME screen will appear.



Example #1
Normal meal bolus using the exchange system

Normal bolus can be used to cover the carbohydrate in a meal or snack and to correct a blood glucose that is higher than the target that was chosen for you.

Fred has been taught that he needs to take 1 unit of insulin for every carbohydrate exchange that he eats (every milk, every starch or every fruit). For lunch today he will eat:

Turkey sandwich with two slices of bread	2 starches
1 small apple	1 fruit
1 cup of non-fat milk	1 milk

Total carbohydrate exchanges = 4

Fred's lunch has a total of 4 carbohydrate exchanges so he will take a meal bolus of 4 units for his lunch.

Bolus practice:

Going through the menus, program a 2.0 unit Normal bolus now.

Check here if you were able to program it.

Using the express bolus button (⏪B), program a 2.0 unit Normal bolus now.

Check here if you were able to program it.

Normal meal bolus practice using exchanges:
Choose a meal you might eat and fill in the blanks.

Food: _____ exchange: _____
_____ exchange: _____
_____ exchange: _____
total exchanges: _____

You will take _____ units of insulin for each exchange. Your total bolus is _____ for this meal.

Example #2:

Normal meal bolus using carbohydrate counting

Lydia has been taught that she needs to take 1 unit of insulin for every 10 grams of carbohydrate. This is her insulin to carbohydrate ratio. For dinner she will have:

4 oz. broiled chicken	0 grams
2/3 cup of rice	30 grams
1/2 cup cooked broccoli	5 grams
1 oz. Dinner roll	15 grams
1 tsp Margarine	0 grams
total grams of carbohydrates =	50 grams

Lydia's dinner totals 50 grams of carbohydrate. Her insulin to carbohydrate ratio is 1 unit: 10 grams. She will take a meal bolus of 5 units for her dinner. She determined this by dividing 50 (total grams of carbohydrate) by 10 (insulin to carbohydrate ratio).

Normal meal bolus practice using carbohydrate counting:

Choose a meal you might eat and fill in the blanks.

Food: _____ grams of carbohydrate: _____
_____ grams of carbohydrate: _____
_____ grams of carbohydrate: _____
total grams of carbohydrate: _____

Your insulin to carbohydrate ratio: 1 unit of insulin for _____ grams carbohydrate.

Divide your total carbohydrates by your insulin to carbohydrate ratio and take _____ units of insulin for your meal.

Example #3:
Meal bolus, correction bolus and insulin sensitivity

3a.

Jason is ready to eat his breakfast. He has calculated that he will need 4.0 units for his food.

He tests his blood glucose and finds that it is 200 mg/dl (11 mmol/L). Jason knows that his blood glucose level is above his pre-meal blood glucose target and will need additional insulin before he eats.

Jason's healthcare professional has determined the following for him:

pre-meal target BG: 110 mg/dL (6.1 mmol/L)

*Insulin sensitivity: 30 mg/dL (1.7 mmol/L)

3b.

Jason determines that he will need a correction bolus of 3.0 units insulin to lower his elevated blood glucose. The 3.0 correction bolus will lower his current BG of 200 mg/dL (11 mmol/L) to his pre-meal target of 110 mg/dL (6.1 mmol/L).

elevated blood glucose: $200 - 110 = 90$ mg/dL ($11 - 6.1 = 5$ mmol/L)

correction bolus: $90 / 30$ (insulin sensitivity) = **3.0 units**

(He will add this 3.0 correction bolus to the 4.0 units of insulin that he will need for his meal bolus. Jason will take a total bolus of 7.0 units.)

* Insulin sensitivity should equal the amount (in mg/dL or mmol/L) that blood glucose will be lowered after taking 1 unit of insulin. To determine insulin sensitivity, divide 1500 by **Total Daily Dose (TDD**)** of Insulin. The answer is your "Correction Factor" (1500 Rule). As always, consult with your healthcare professional for guidance.

** TDD = Total amount of basal and bolus insulin delivered in a 24-hour day.

Practice: Meal bolus

You have determined your meal bolus as: _____ units.

Your pre-meal target blood glucose range is: _____ to _____ (average is _____).

Your current blood glucose level is: _____.

Your correction factor is: 1 unit of insulin will drop your BG _____.

You will take _____ unit(s) of insulin to correct your high BG level.

Your total bolus (meal bolus plus correction bolus) is _____.

Review your bolus deliveries

You can view a list of your bolus deliveries in the BOLUS HISTORY screen. This screen shows a list of the dates, times, units, and types for your last 24 boluses. This feature is helpful for record keeping or to check if you bolused for your last meal.

If a bolus was stopped before delivery was complete, the BOLUS HISTORY screen will show only the amount actually delivered. Refer to the next section, "Bolus details" for instructions about viewing bolus details.

Do the following steps to view the BOLUS HISTORY screen:

1. Go to the BOLUS HISTORY screen and scroll through the bolus deliveries.

Main > Bolus > Bolus History

If you used Bolus Wizard to deliver any of these boluses, the screen shows the carbohydrate/food (CH) and BG values that Bolus Wizard used to calculate the boluses.

2. Refer to the instructions in the next section, "Bolus details" to see the details for any of these boluses.

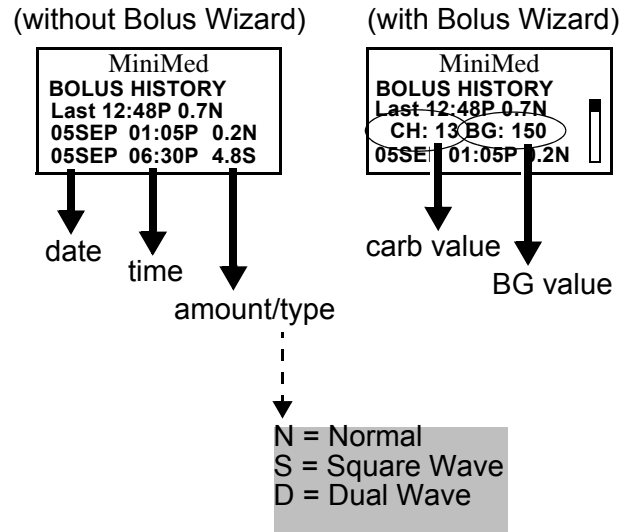

Bolus details

You can view the details for any of the deliveries in the BOLUS HISTORY screen. The details include:

- ▶ bolus type: **N** (Normal),
S (Square),
D (Dual),
DS (Dual Square portion),
DN (Dual Normal portion).
- ▶ programmed bolus amount
- ▶ delivered bolus amount
- ▶ Bolus Wizard information (if used)

To see the details for any bolus, do these steps:

1. In the BOLUS HISTORY screen, select the bolus that you want to review and press **ACT**.
2. The details for that bolus will appear on the screen. Scroll through the details.
3. Exit when you are done.

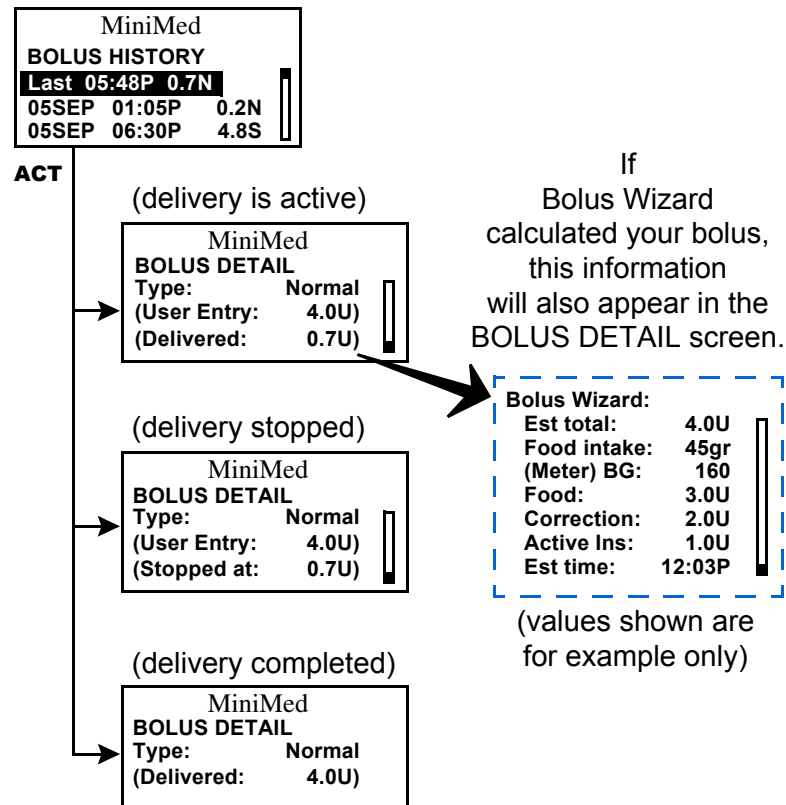

Maximum bolus limit

The maximum bolus (max bolus) is a safety feature that limits the amount of insulin that can be delivered in a single bolus. The factory setting is 10.0 units. You can specify the limit from 0.0 to 25.0 units. It is important to discuss this feature with your healthcare professional to determine your maximum bolus amount.

To set the maximum bolus limit, do these steps:

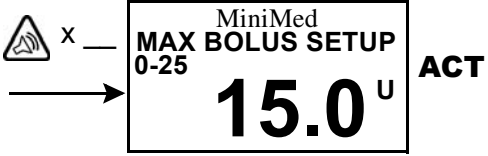
<p>1. Go to the MAX BOLUS SETUP screen. Main > Bolus > Max Bolus</p>  <p>(flashing)</p>	<p>2. Set your maximum bolus limit and press ACT.</p>  <p>The diagram shows a transition from the initial screen to a new screen where the value is 15.0 U. A hand icon with an 'x' and an arrow points to the right, indicating the user's action. The word 'ACT' is written to the right of the second screen.</p>	<p>3. Your maximum bolus is set. Exit the menus.</p>
---	---	--

Example #1: Max bolus

Shelby takes very small doses of insulin for her meal boluses. As a safety limit, she and her healthcare professional reset her pump with a maximum bolus of 5.0 units.

Example #2: Max bolus

David is a growing teenager. He loves to eat big meals and requires very large doses of insulin for his food. He reset his pump with a maximum bolus of 20.0 units so he can take more insulin when he needs to.

Basal

Basal insulin is required to maintain your target glucose values when you are not eating. Your healthcare professional will calculate this rate for you. Your basal insulin should account for approximately one half of the body's total daily insulin requirements. Your pump mimics your pancreas by delivering insulin continuously over 24-hours.

You can set your insulin pump to change rates during the day to match your needs. Your needs depend on your lifestyle and insulin requirements. Some people only use one rate throughout the day, while others find they need more. Your basal rates are made up of insulin deliveries that have start and stop times. Once set, these rates make up your 24-hour basal pattern and are repeated daily.

Start and stop times

When you set your basal rate(s) in the BASAL MENU, your pump prompts you to set the start time for each basal delivery. The stop time is the time that one basal rate stops and the next basal rate starts (see figure).

It is recommended that you record your basal rates on paper. The Quick Reference card is provided with your pump for this purpose. For best results, setting or changing your basal rate(s) should be discussed with your healthcare professional.

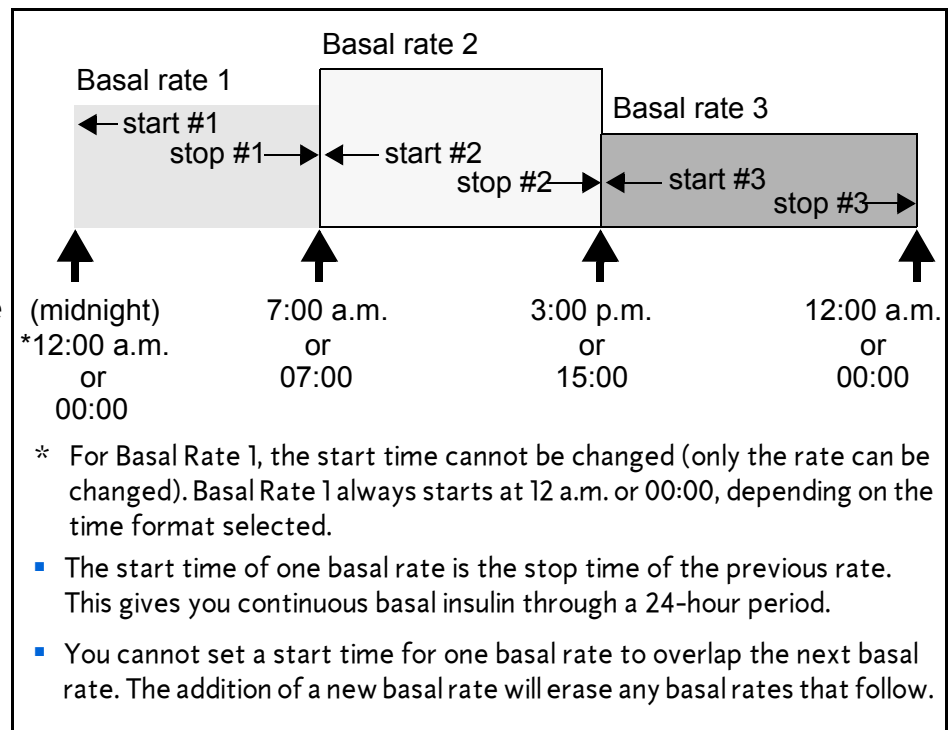

Your basal settings

You must program your basal settings before you can deliver basal insulin. Keep a written record of your basal settings.

It is recommended that you set your basal rates with the assistance of your healthcare professional.

If you plan to take off your pump for an extended period of time, i.e. more than a day, set the basal rate to 0.00U/H. This will ensure that the insulin delivery records in your pump are accurate. Refer to the section, "If you remove your pump" in chapter 2 for more information.

Basal programming and delivery

To set your basal rates, do these steps:

NOTE - You cannot make changes to your basal rate settings while a percent (%) temp basal is active.

1. Go to the BASAL MENU.

Main > Basal

2. Select **Set/Edit Basal** and press **ACT**.
3. The SET BASAL RATE 1 screen will appear. Enter your first basal rate amount and press **ACT**.

NOTE - The start time for your first basal rate is midnight (12:00A) and cannot be changed.

4. The screen will change to SET START TIME 2. If you only need one basal rate for the entire 24-hour day (12:00A to 12:00A), do these steps:
 - a. Press **ACT** or **ESC** without setting a start time.
 - b. The BASAL RATE screen will appear with your basal data. Your daily basal rate is now programmed. It will deliver daily from 12:00A to 12:00A.
 - c. Exit the menus.

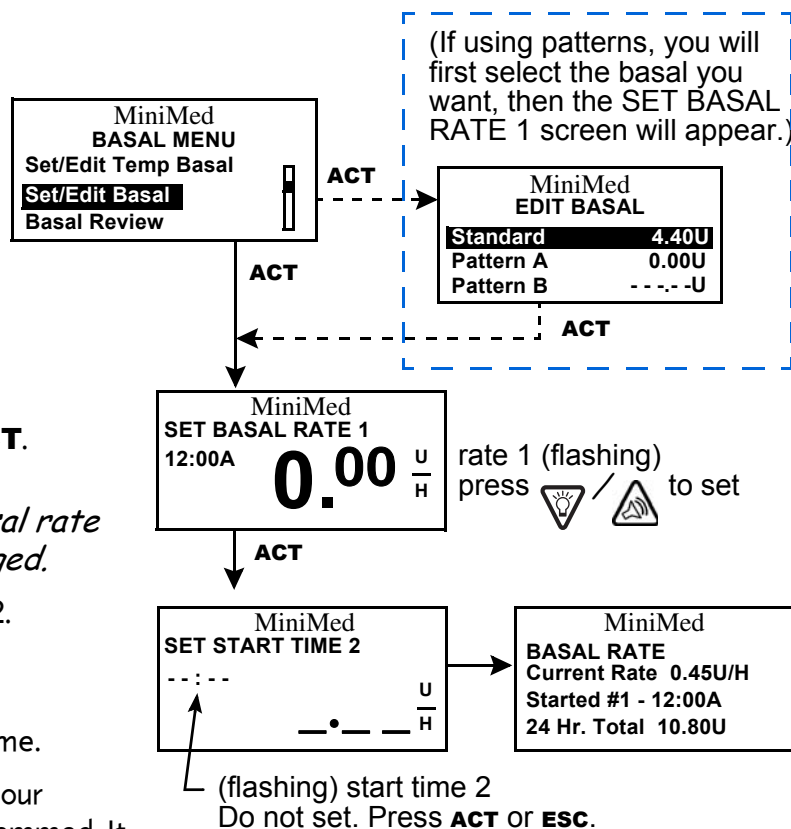

If you need to program more than one basal rate for the day, do these steps:

- In the SET START TIME 2 screen, enter the start time for the next rate and press **ACT**.
- The SET BASAL RATE 2 screen will appear. Enter the rate and press **ACT**.
- Repeat steps **a** and **b** for each additional basal rate. Each rate will have a different number (i.e. Basal Rate 1, Rate 2, Rate 3, etc.).
- After you program your last basal rate, press **ESC**.
- The BASAL RATE screen will appear. Your basal rate(s) will now deliver as programmed. Exit the menus.

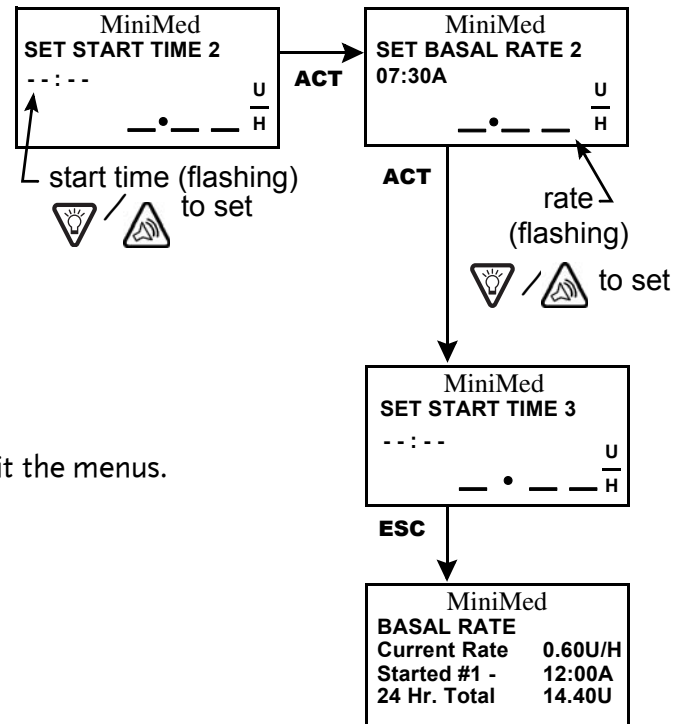

Practice: Basal programming

Make sure you are **NOT** connected to your pump while practicing.

Set a basal rate of 0.5 unit per hour.

Check here if you were able to set the basal rate:

What is the total basal insulin for 24-hours? ____ (answer: 12 units)

Basal review

Temporary basal information is only available in the STATUS screen.

Current basal delivery

The STATUS screen shows your current basal information.

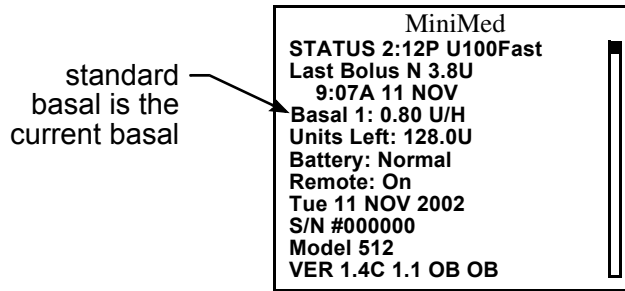

Daily basal rate(s)

The BASAL REVIEW screen shows your daily basal rates programmed for delivery from midnight to midnight (12:00A to 12:00A). Compare your daily insulin deliveries to your blood glucose records to help you and your healthcare professional identify your optimal daily insulin rate(s).

1. Go to the BASAL MENU. Select **Basal Review** and press **ACT**.

Main > Basal



2. If you do not use patterns:

The delivery details for your standard basal will appear.

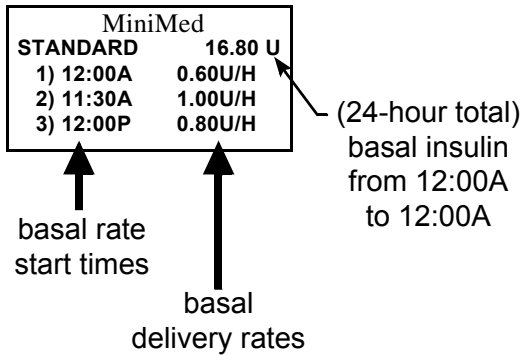

If you use patterns:

The screen will show the basal patterns. The current basal pattern will be highlighted. Select pattern you want to view. Press **ACT**.

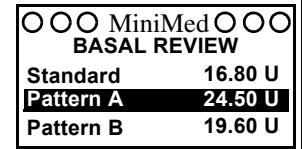

The start time and units for each delivery rate in that pattern will appear.

(24-hour total basal insulin from 12:00A to 12:00A)

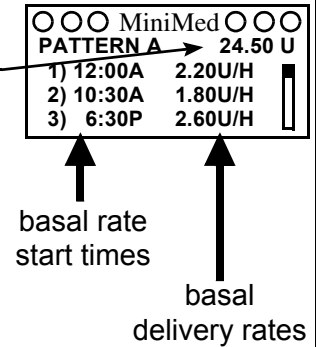



3. Exit the menus when you are done.

Max basal rate

Maximum basal rate is a safety limit for the amount of basal insulin that is able to be delivered per hour. This maximum rate will apply to every basal that is set, including a temporary basal. It is important to discuss what your max (maximum) basal rate should be with your healthcare professional.

Your pump is sent from the factory with the maximum basal set to two (2.0) units per hour. Once your basal rates have been set, you CANNOT set a maximum basal that is less than any of the programmed basal rates --this includes patterns and temporary basal rates.

To set your max basal rate, do these steps:

<p>1. Go to the MAX BASAL RATE screen. The maximum basal will be flashing.</p> <p>Main > Basal > Max Basal Rate</p> <div data-bbox="236 639 509 831" style="border: 1px solid black; padding: 5px; text-align: center;"><p>MiniMed MAX BASAL RATE 2.00 $\frac{U}{H}$ (flashing)</p></div>	<p>2. Change the rate and press ACT.</p> <div data-bbox="735 639 1206 799" style="text-align: center;"> x  <div data-bbox="870 639 1147 799" style="border: 1px solid black; padding: 5px; text-align: center;"><p>MiniMed MAX BASAL RATE 15.00 $\frac{U}{H}$</p></div> ACT</div>	<p>3. Your maximum basal rate is now set. Exit the menus.</p>
--	---	---

Example #1: Max Basal

Helen has a very low insulin requirement. Her highest basal rate is only 0.4 units per hour. As a safety measure, Helen's healthcare professional set her pump with a Maximum Basal Rate of 1.0 units per hour.

Example #2: Max Basal

Rusty needs large amounts of insulin to control his blood glucose levels. His new pump was delivered from the factory with a Maximum Basal Rate of 2.0 units per hour, but he needs 2.8 units per hour in the early morning. Rusty will reprogram his Maximum Basal to 3.0 units per hour to accommodate his needs.

Stopping your pump

You can stop your pump with the suspend function. Suspend stops all insulin delivery including the current basal and any bolus or prime deliveries that are in progress. While suspended, your pump will not deliver insulin until you Resume your pump. When basal is resumed, the pump is taken out of the Suspend mode.

The pump will beep or vibrate about every 15 minutes on the hour to remind you that it is not delivering insulin. Example: You suspend your pump at 11:20AM. The pump will beep/vibrate at 11:30AM, 11:45AM, 12:00PM, and so on until you resume your pump (basal resumes).

NOTE - When suspended, your pump is in Attention mode (solid circles). When in Suspend, you can only resume your basal or view the STATUS screen. No other functions are available.

Do these steps to suspend your pump:

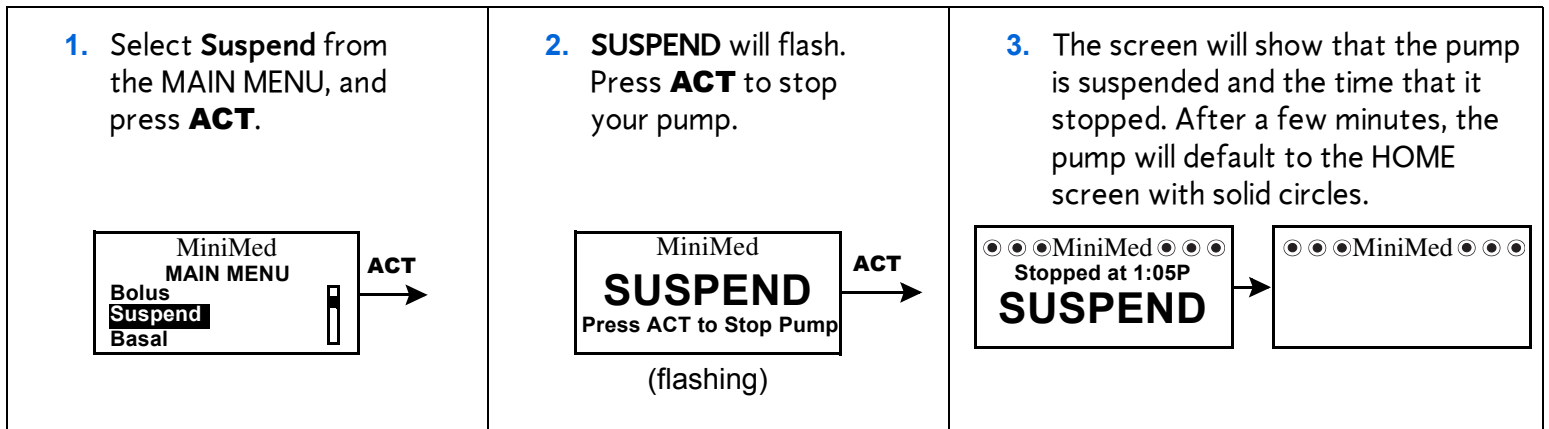

NOTE - Press **ESC** to view the STATUS screen and verify your pump is suspended.

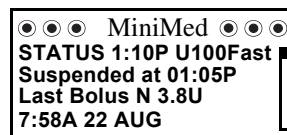

Example:
Suspend function

1. Josh has been on a Medtronic MiniMed pump for several months. He is very active in soccer and basketball. He and his healthcare professional have determined that he does not need his basal insulin during his games, and that he is able to take the pump off for these short amounts of time. Josh uses the "Suspend" feature on his pump to stop the basal insulin during the time that he is disconnected from his pump. He will "Resume" delivery when he reconnects the pump.
2. Helen is ready to eat her lunch. She has just programmed her pump to deliver a meal bolus when the phone rings. Helen wants to talk on the phone and not eat her lunch right away. She knows that if she lets the bolus continue and she does not eat her lunch soon, she may be at risk for low blood glucose. Helen "Suspends" delivery of her pump to stop the bolus, but then "Resumes" delivery to restart her basal insulin. When she is off the phone and ready to eat, she checks her STATUS screen to see how much insulin she received from the partially delivered bolus before she suspended her pump. She will reprogram a new bolus for the remainder.

Practice:
Suspend function

1. **Make sure you are NOT connected to your pump while practicing.**

Program your pump to deliver a Normal bolus of 3.0 units.

Once the bolus begins, stop the bolus by suspending your pump.

Remember, when you stop the bolus delivery with "Suspend," ALL insulin delivery will stop.

2. Now, "Resume" delivery, so that your basal insulin will continue.
3. Check the STATUS screen.

How much insulin did the bolus deliver before you Suspended delivery? _____.

If you wanted to take the rest of the bolus later, how much would you take to equal 3.0 units? _____.

Resume pump delivery

When the pump is suspended, it defaults to the HOME screen with solid circles. Do these steps to resume your pump and basal delivery:

1. From any screen, press **ACT** until the RESUME screen appears. Press **ACT** again.
2. Your pump will beep once, then the HOME screen will appear (with no circles).

NOTE - A bolus or fixed prime that was stopped by suspend will *not* restart when you resume your pump. You must reprogram and activate it to finish delivery.

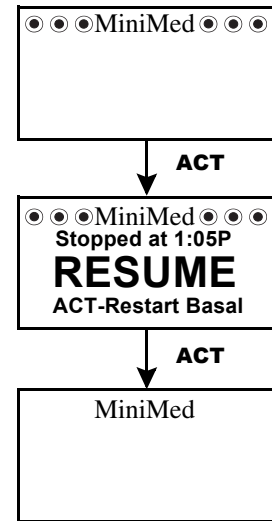

Practice:

Resume basal delivery after a suspend

Make sure you are NOT connected to your pump while practicing.

Give a 3.0 unit bolus now. While it is delivering, suspend the bolus.

Check here if you were able to suspend the bolus.

Now restart the pump.

Check here if you were able to restart the pump.

Prepare your pump for use

Before continuing with the steps in this chapter, we recommend that you watch your pump training video and complete your pump start training.

When you are done practicing and ready to use your pump with insulin, you must:

<ol style="list-style-type: none"> 1. do a "Clear pump" function 2. set the time and date, 3. program your settings as instructed by your healthcare professional, 	<p>Refer to the applicable chapters.</p>
<ol style="list-style-type: none"> 4. install the reservoir, and 5. prime the infusion set. 	<p>You will need these items:</p> <ul style="list-style-type: none"> ➡ Pump ➡ Insulin ➡ Paradigm reservoir and user guide ➡ Paradigm infusion set and user guide <p>Refer to the sections in this chapter.</p>

Filling the reservoir

WARNING: Your pump will not accurately deliver insulin if air bubbles are in the reservoir or the infusion set. To prevent this, take care to remove air bubbles when filling your reservoir.

1. Remove reservoir from package. Make sure plunger rod is fully extended.

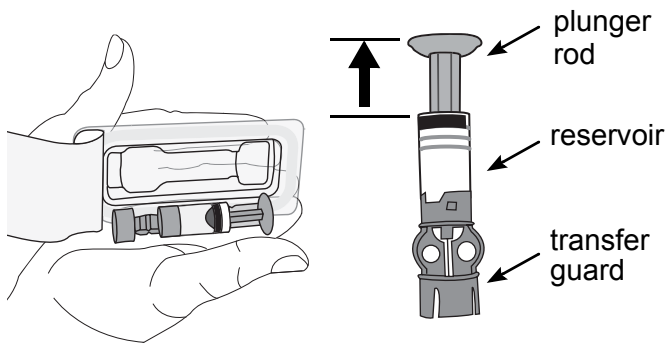

2. Swab vial with alcohol.
3. Making sure you do not push down on the plunger, press the transfer guard onto the vial.

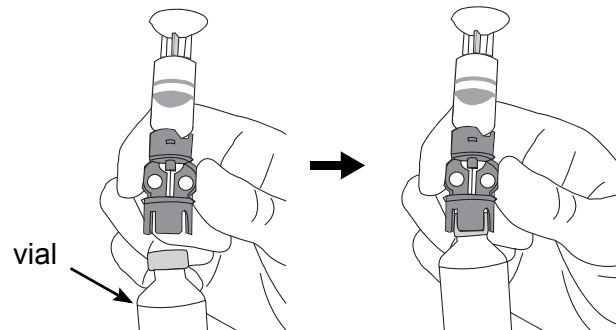

4. Push down on the plunger to pressurize the vial.

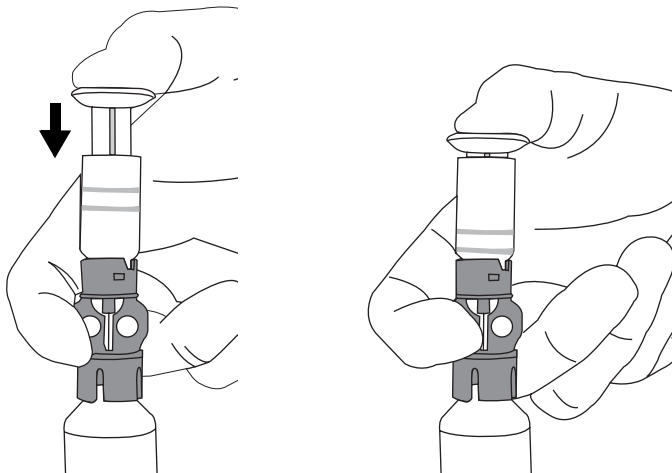

5. With the vial up, slowly pull down on the plunger to fill the reservoir.

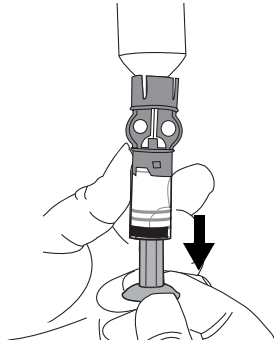

6. Tap the side of the reservoir to make any air bubbles rise to the top of the reservoir.

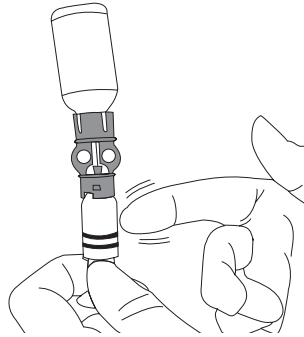

7. Slowly push up on the plunger just enough to remove any air bubbles from the reservoir.

Slowly pull down on the plunger to completely fill the reservoir.

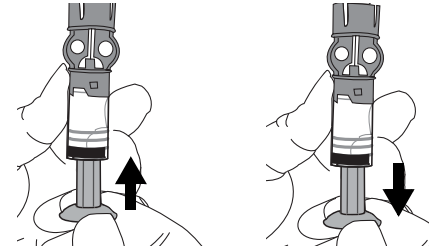

8. While holding the reservoir, turn the transfer guard counter-clockwise then pull straight up to remove it from the reservoir.

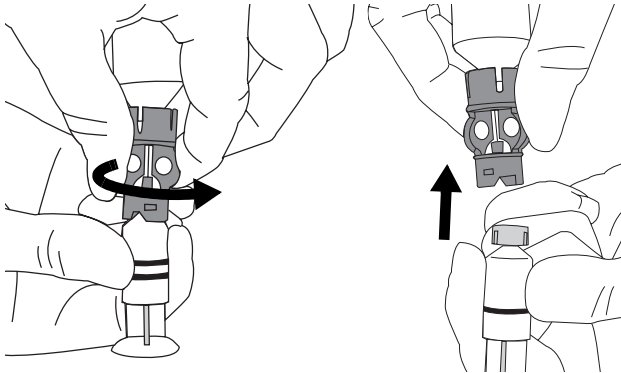

9. Put the tubing connector on the reservoir. Turn it clockwise to secure.

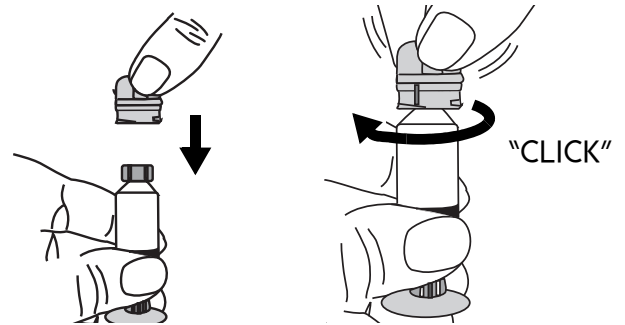

10. Tap the side of the reservoir to remove any air bubbles.

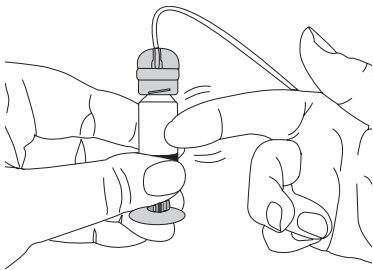

11. To purge air bubbles that have risen to the top of the reservoir, push up on the plunger until you see insulin in the tubing.

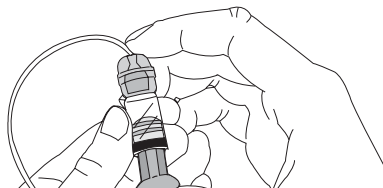

12. Without pulling, turn the plunger counter-clockwise to remove it from the reservoir.

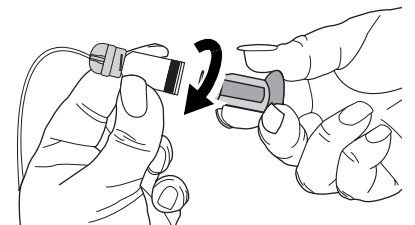

Changing your infusion set

Removing the reservoir

Each time you remove and replace a reservoir in your pump, you have to rewind and prime your pump. Priming requires insulin.

1. Remove the entire infusion set from your body.
2. If attached, remove the activity guard.
3. Turn the tubing connector 1/2-turn counterclockwise, then pull the reservoir and connector out from the pump.

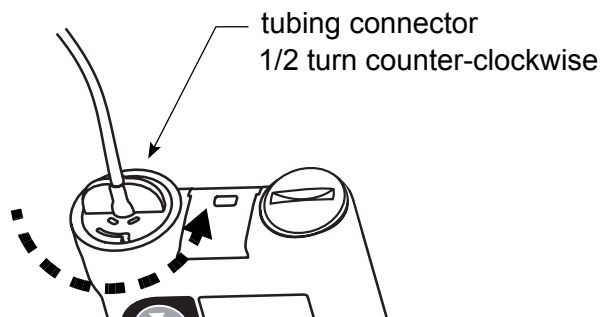

4. Safely dispose of the used reservoir and infusion set items.
5. You must now rewind your pump as described in the next section.

Rewinding your pump

Before you continue, make sure the pump is NOT connected to your body.

WARNING: Make sure the infusion set is disconnected from your body before you rewind or prime the pump. Never insert the reservoir into the pump while the tubing is connected to your body. Doing so could result in an accidental infusion of insulin.

1. If you removed your reservoir and are replacing it, go to the REWIND screen.

Main > Prime > Rewind

***NOTE** - If you just changed your insulin type and the HOME screen appears, you can press **ACT** to make the REWIND screen appear.*

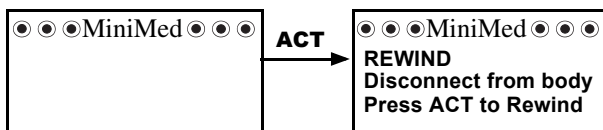

2. In the REWIND screen, press **ACT** to start the rewind process. The REWINDING screen will appear while the pump rewinds.
3. After the pump rewinds, the MANUAL PRIME screen will appear.

***NOTE** - If you press **ESC**, the pump will go back to the REWIND screen. Once you start a rewind, you cannot cancel it.*

If you are **practicing**, do these steps:

- a. Do **NOT** insert the reservoir in your pump. Make sure the shipping cap is installed in the reservoir compartment.
- b. Continue with the manual prime instructions described in the "Manual prime" section on page 41.

If you are **not practicing**, continue to the next section, "Inserting the reservoir in your pump."

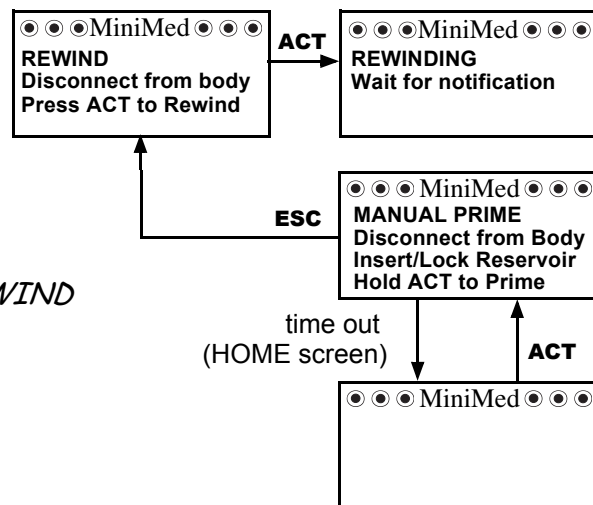

Inserting the reservoir in your pump

If your reservoir is already inserted in your pump, continue to the next section, “Manual prime.”

You must do these steps in the order described. Your pump screen will show instructions to help you with these steps. If you are practicing, do **NOT** insert the reservoir in your pump.

CAUTION: You must rewind your pump before installing a new reservoir. As part of the pump’s function, it measures the reservoir volume. To ensure correct volume measurements, your pump has been designed to require a rewind before you change your reservoir.

1. If you are using the pump for the first time, remove the shipping cap from the reservoir compartment.

WARNING: Do not insert the reservoir in the pump if you did not rewind. Doing so could result in inaccurate insulin delivery.

Never insert the reservoir into the pump while the tubing is connected to your body. Doing so could result in an accidental infusion of insulin.

2. Insert the reservoir into the top of the pump case.

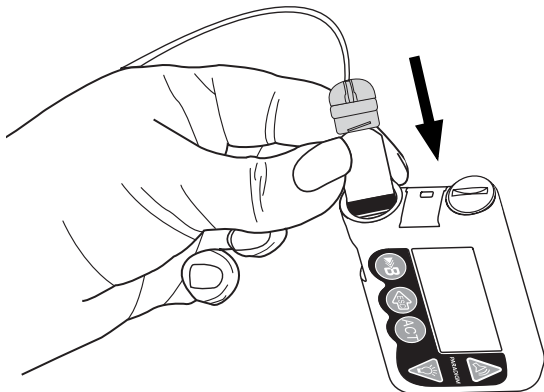

512 pump shown;
712 pump similar

3. Turn the tubing connector approximately 1/2-turn clockwise until the connector is seated. The tubing connector should be aligned horizontally with the pump case as shown here.

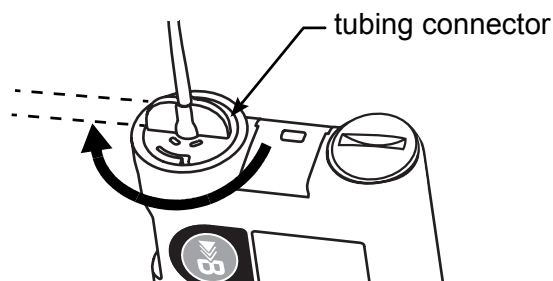

4. Attach the activity guard, if desired.
5. You must now do a manual prime as described in the next section.

Manual prime

Manual prime fills the infusion set tubing with insulin before you attach it to the infusion site. Manual prime is only available after you rewind your pump.

WARNING: Make sure the infusion set is disconnected from your body before you press **ACT** to prime the pump. Never insert the reservoir into the pump while the tubing is connected to your body. Doing so could result in an accidental infusion of insulin.

1. After you rewind your pump, the MANUAL PRIME screen will appear.

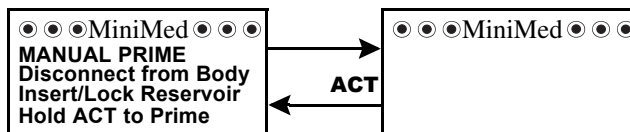

The pump may time out to the HOME screen while you install the reservoir. Press **ACT** to get the MANUAL PRIME screen again.

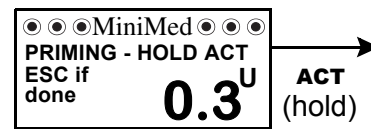
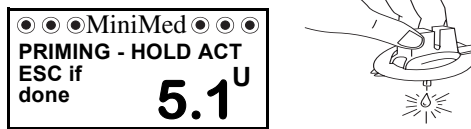
<p>↓ ACT (hold)</p>  <ol style="list-style-type: none">2. Press and hold ACT to start the prime. The pump will beep 6 times indicating the prime has started.	 <ol style="list-style-type: none">3. While you hold ACT, the pump will beep again 6 times as the screen begins counting the prime units being used. <p>ATTENTION: If you release the ACT button and the pump times out to the HOME screen:</p> <ol style="list-style-type: none">a. Press ACT. The Manual Prime screen appears.b. Press ACT again to continue the prime sequence (screen shows where you left off), or Press ESC to rewind.	 <ol style="list-style-type: none">4. Continue to hold ACT until insulin droplets form on the tip of the infusion set needle, then release. Be sure no bubbles are in the tubing. <p>WARNING: It is very important that the PRIMING - HOLD ACT screen appears and shows the count of insulin units while the tubing fills. If the PRIMING - HOLD ACT screen does not appear, do NOT continue. Do NOT insert the infusion set into your body. Call the 24-hour Product Help Line for assistance.</p>
--	---	--

WARNING: Your pump will not accurately deliver insulin if there are air bubbles in the infusion set. Take care to remove any air bubbles during the manual prime.



If your manual prime uses more than 30U insulin, the pump will ask you, "is priming complete?" If you get this message, do these steps:

- a. Make sure you are not connected to the pump.
- b. Read the message on the screen, then press **ESC**, **ACT** to clear.
- c. If your manual prime is complete (you see droplets on the tip of the infusion set needle), press **ESC** and continue to step 5. If your manual prime is not complete, press and hold **ACT** until priming is complete then continue to step 5.

5. Press **ESC**. Your manual prime is complete.
6. You can now insert the infusion set into your body as described in the next section.

Insert the infusion set

WARNING: While the infusion set is connected to your body, do not unscrew and retighten the tubing connector on the reservoir.

After you complete all of the following, you will be ready to insert the infusion set into your body:

- ➔ fill your reservoir
- ➔ rewind your pump
- ➔ confirm your insulin type and
- ➔ prime the pump (fill the infusion set with insulin)

It is important that you change your infusion set every 2-3 days. Medtronic MiniMed offers a number of different infusion sets for your pump. Instructions for the Quick-set® begin on the next page as an example. Always refer to the instructions that shipped with your infusion set. After your infusion set is inserted, continue to the section, "Fixed prime."

Quick-set infusion set (with Quick-serter®)

Instructions are also included with the infusion set.

1. Wash your hands.

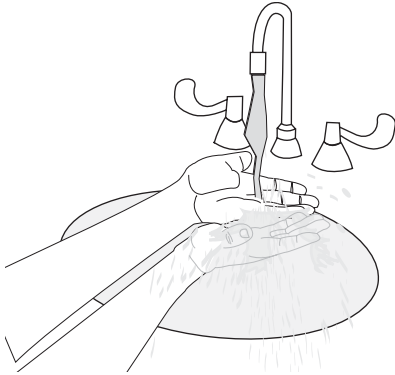

2. Clean and dry the infusion site.

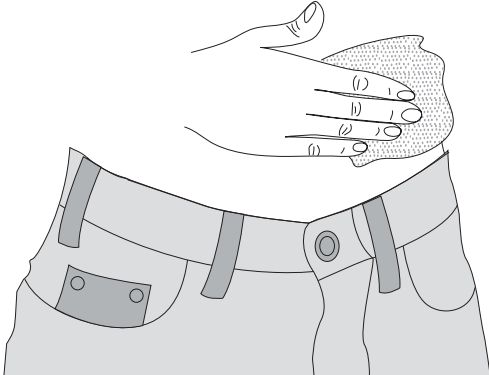

3.

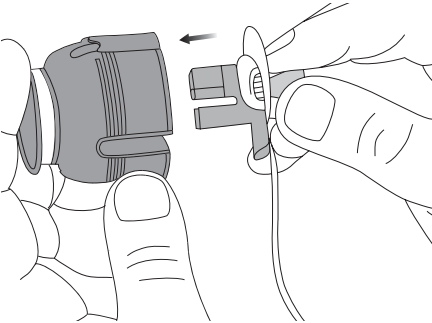

4.

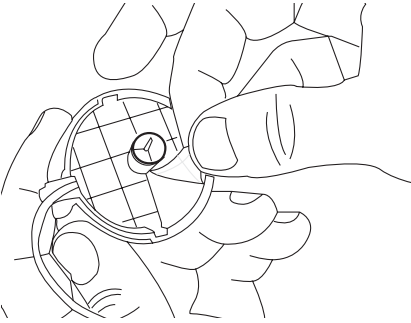

5.

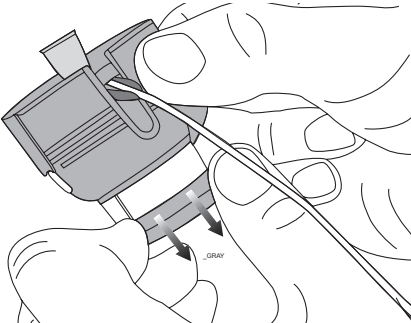

6.

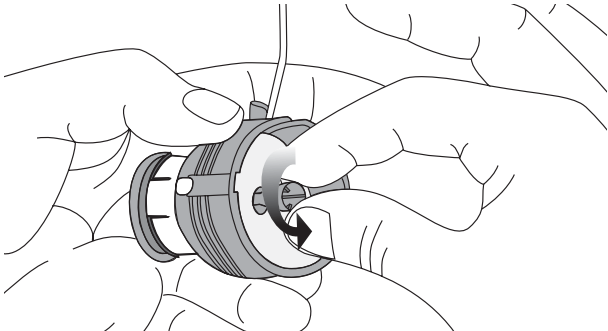

7.

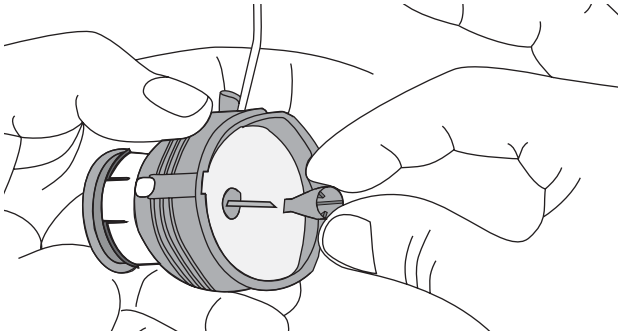

8.

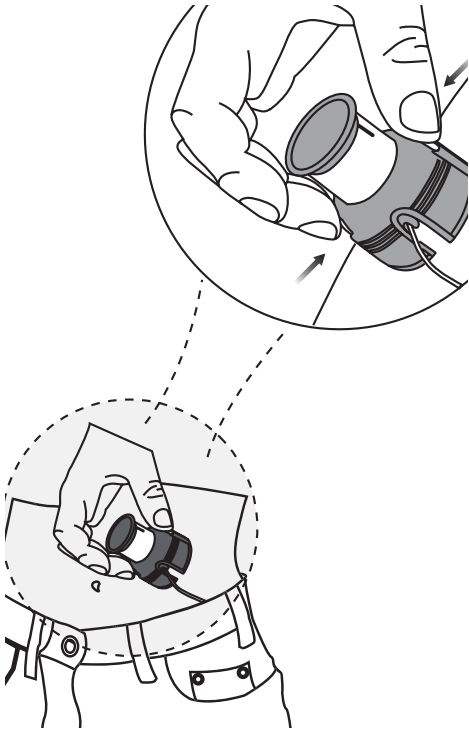

9.

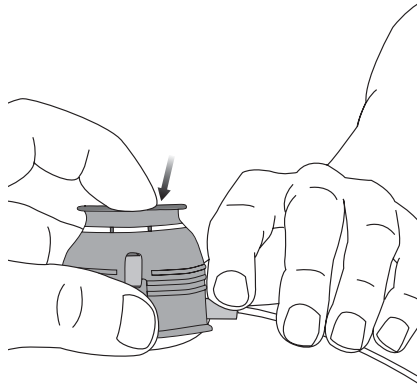

10.

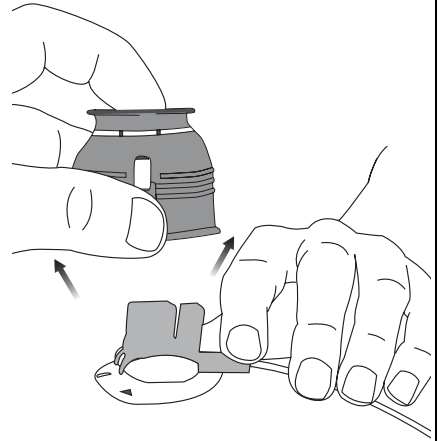

11.

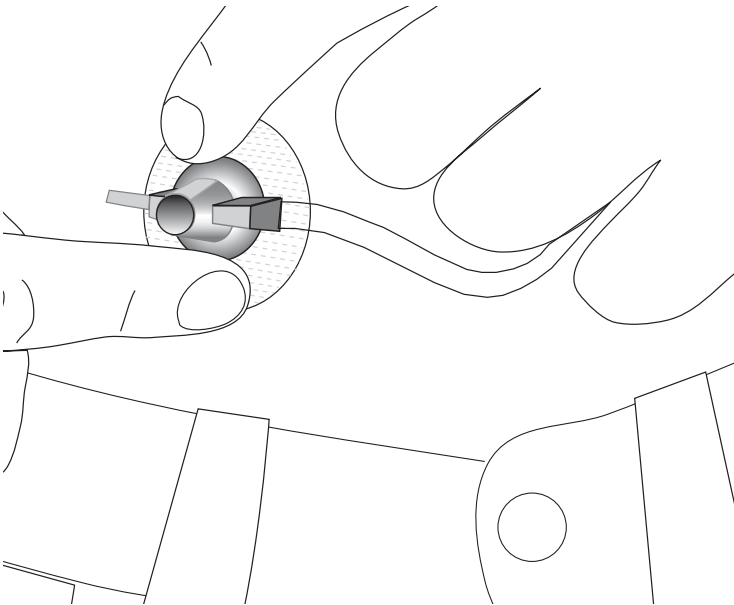

12.

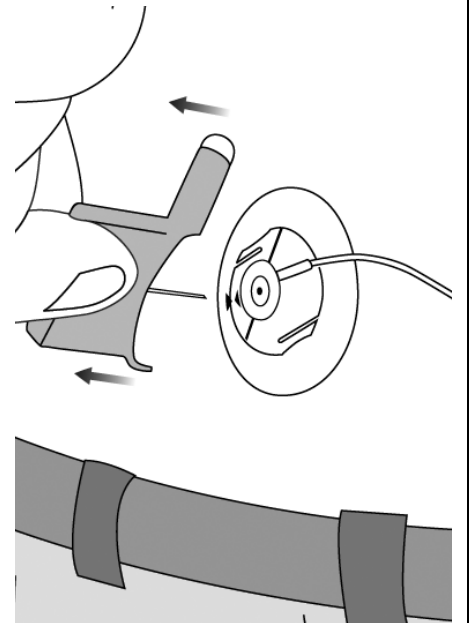

Connecting Quick-set

If you inserted a new reservoir, you should have already done a manual prime. A manual prime is always done to fill the infusion set tubing with insulin after you rewind your pump and insert the reservoir. If you are changing your infusion set without changing your reservoir, do a fixed prime to fill the tubing. Refer to the section, "Fixed prime" on the next page for instructions.

Place the connector part (flat-side facing down) on the infusion set until it is fully seated. Do **not** grip the connector part by the flat side-grips.

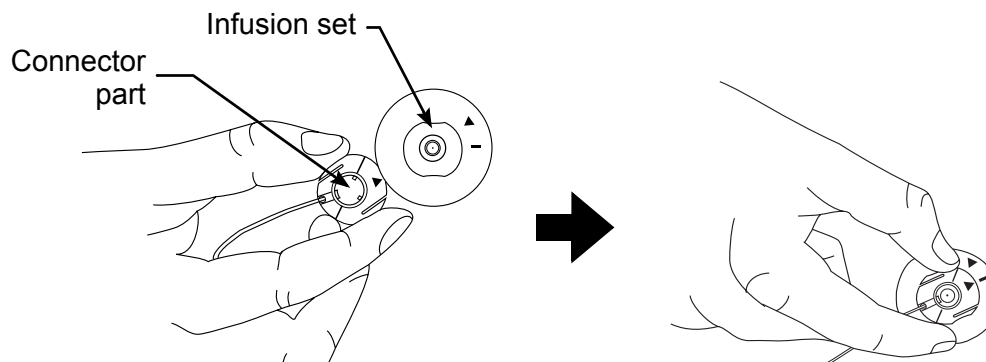

Disconnecting Quick-set

The Quick-set allows you the freedom to temporarily disconnect from your pump without removing the infusion set from your body.

Squeeze the side grips of the connector part with your fingers.

Side grips

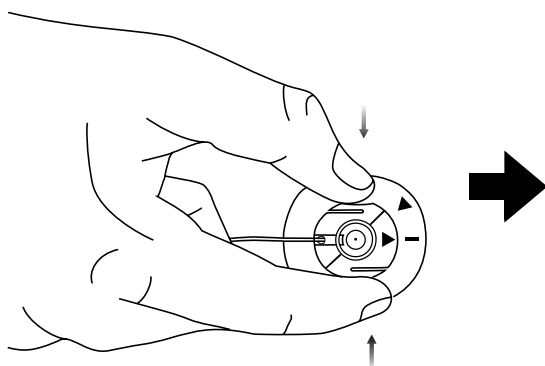

Remove the connector from the site.

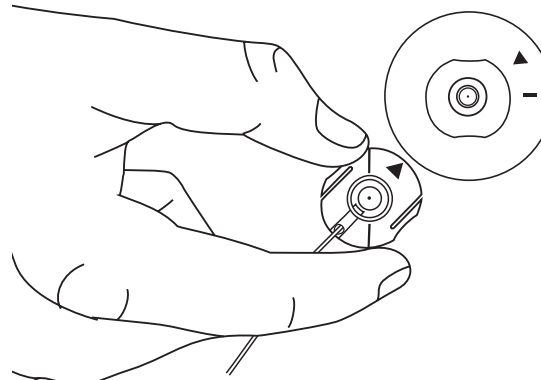

Fixed prime

A fixed prime fills the soft cannula with insulin and is required after the infusion set is inserted into your body. You will start the fixed prime after the introducer needle is removed. Additionally, a fixed prime is required if you disconnect your quick release and you need to reprime the infusion set or if you change your infusion set without changing the reservoir.

NOTE - Prime amounts depend on the type of infusion set you are using. Refer to your infusion set instructions for your fixed prime amount.

1. Go to the PRIME MENU.

Main > Prime

2. Select **Fixed Prime** and press **ACT**.



3. In the **FIXED PRIME** screen, enter the amount for your type of infusion set, then press **ACT**.

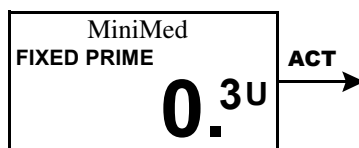

4. Once the prime begins, the **PRIME DELIVERY** screen will count up the units as they are delivered. A "beep" will sound when priming is complete.



Prime history

Do these steps to see a list of the delivered primes.

1. Go to the PRIME MENU.

Main > Prime

2. Select **Prime History** and press **ACT**.



3. The **PRIME HISTORY** screen will appear.

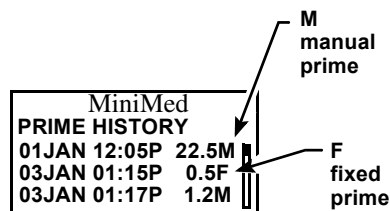

4. Scroll through the list of prime deliveries. The "F" at the end of the text line indicates a fixed prime. An "M" indicates a manual prime. Exit the menus.

Record keeping for diabetes management

Now that you are using the pump with insulin, we will be asking you to test your blood glucose regularly. The information from your blood glucose journal is your healthcare professional's only method of making adjustments in your pump settings. It is important to test often and write down your blood glucose readings, the food you eat, any exercise you perform and any other notes to explain your blood glucose results.

You must test at the recommended times and any other time that you feel your blood glucose is high or low. Be sure to include your meal boluses, correction boluses, the amount of carbohydrate you eat, basal rate and any other information that will be helpful in assisting your healthcare professional in adjusting your pump settings.

It is very important to look at your blood glucose readings as feedback regarding your diabetes management, not as statements about you or your self-worth. Try not to have an emotional reaction to the numbers and do not judge them too harshly. You will soon learn how to modify the numbers easily and precisely through insulin pump therapy.

TEST AT LEAST 4-6 TIMES A DAY.

These are the recommended times to test to determine control:

- ➡ Overnight (occasionally, at approximately 2 - 3 AM)
- ➡ Pre-breakfast (fasting)
- ➡ Post-breakfast (approximately 2 hours after eating)
- ➡ Pre-lunch
- ➡ Post-lunch (approximately 2 hours after eating)
- ➡ Pre-dinner
- ➡ Post-dinner (approximately 2 hours after eating)
- ➡ Bedtime
- ➡ Before driving

Determining your pump settings

Your healthcare professional will use your daily blood glucose journal records to program your pump. It is very important to keep good records during the first weeks after you start on pump therapy. Not only must you record your blood glucose readings, but it will be important to eat regularly scheduled meals and to keep your activity as consistent as possible.

Until you and your healthcare professional determine the pump settings that will work best for you, it is important to eat meals for which it is easy to count the carbohydrates. After your correct basal rate is determined, you will be able to experiment with varied food choices and amounts.

After you and your healthcare professional are satisfied with your initial pump settings, you may begin to experiment with different food choices, meal times and exercise schedules.

Using your daily journal

To use the daily journal that came with your pump, follow these easy steps:

1. Write the day and date in the spaces provided on the top of the page.
2. Find the time of the entry you are making. Test your blood glucose and enter the value in the space labeled "blood glucose."
3. If you are eating at this time, write the grams of carbohydrates in the space labeled "carbohydrates."
4. If you are taking a correction and/or meal bolus, record it in the space labeled "meal bolus" and/or "correction bolus." Even if you have added these together to take one bolus, write the separate amounts in the corresponding spaces.
5. Record your basal rate in the space labeled "basal rate." If you have more than one rate, be sure to record the rate in the space corresponding to the correct time for each rate.
6. When you exercise, write the minutes in the space labeled "exercise." If you test your urine ketones, write the result in the space labeled "urine ketones." Each time you test your ketones, write the result even if it is negative.
7. Record the time you change your infusion set in the space labeled "set change." This notation will help you to evaluate any changes in your blood glucose readings due to changing your infusion set.
8. Record the food you eat in the "breakfast," "lunch," and "dinner" columns.
9. In the "notes" section, write down any information that may explain your blood glucose values or diabetes management decisions. Use this section as you would a personal journal.
10. At the end of the journal, there are blood glucose graphs. To draw your blood glucose graph for the day, find the time you tested and follow the line up until you reach the corresponding blood glucose on the left. Once you find it, mark a dot on the graph that corresponds to the correct time and blood glucose value. At the end of the day, connect the marks and draw your graph. This graph will be helpful in looking at patterns in your blood glucose values from day to day.

What is it?

The Bolus Wizard is an optional feature of the pump that calculates an estimated bolus:

➔ to support your food intake

AND/OR

➔ to correct high blood glucose

Information you need...

Food entry

You need to know how many exchanges or grams of carbohydrates you are going to eat. (You need to know what foods contain carbohydrate and understand carbohydrate counting.)

Your BG reading

You need to know your BG reading. When using the Bolus Wizard, the pump can work with the Paradigm Link Blood Glucose Monitor Powered by BD Logic Technology (Paradigm Link meter) to automatically receive your BG reading. The section "Meter option" in this chapter has more information. If you are not using this meter, you will manually enter your BG.

Your personal Bolus Wizard settings

In addition to your BG reading and/or your food entry, Bolus Wizard uses personal settings that you enter during Bolus Wizard programming. (Instructions are in the section, "How to program Bolus Wizard.")

- ➔ **Carb units** (grams or exchanges)
- ➔ **Carb (food) ratios** (in carbohydrate grams/unit of insulin or insulin units/carb exchanges)
- ➔ **BG units** (mg/dL or mmol/L)
- ➔ **insulin sensitivity**
- ➔ **target blood glucose**

You should get this information from your healthcare professional. Also, for best results, talk to your healthcare professional before making any changes. Keep a record of your settings in the Bolus Wizard settings table on the next page.

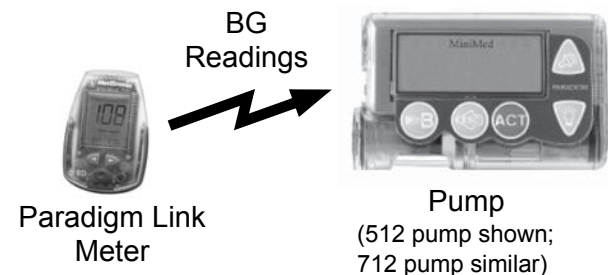

Make sure
you receive your Bolus Wizard settings
from your healthcare professional.

Bolus Wizard settings table

Name: _____ Date: _____

Refer to this table when you setup the Bolus Wizard
as described in the section, "How to program Bolus Wizard."

Information	Setting	
Carb units:	select: ___ Grams or ___ Exchanges	
Carb ratios: Bolus Wizard uses this for your food bolus calculations. If you count carbs: this ratio is the amount of carbohydrate grams covered by one (1) unit of insulin. range: 3 – 75 grams/unit If you count exchanges: this ratio is the amount of insulin you need to cover one (carb) exchange. range: 0.2 – 5.0 units/exchanges <hr style="border: 1px solid blue;"/> NOTE - Your carb ratios may vary throughout the day. Your pump allows you to program up to eight (8) different carb ratios, if needed.	grams / unit or insulin units/exch	start time
	#1: _____	(midnight)
	#2: _____	
	#3: _____	
	(additional settings, if needed)	
	#4: _____	
	#5: _____	
	#6: _____	
	#7: _____	
	#8: _____	
BG units: (how you measure your BG)	select: ___ mg/dL or ___ mmol/L	

Bolus wizard settings table (continued)

Name: _____ Date: _____

Information	Setting	
<p>Insulin sensitivity: Bolus Wizard uses this ratio for your correction bolus calculations.</p> <p>This ratio is the BG units reduced by 1.0 unit of insulin</p> <p>range: 10 – 250 mg/dL or 0.5 - 13.9 mmol/L</p> <hr style="border: 1px solid blue;"/> <p>NOTE - Your insulin sensitivity may vary throughout the day. Your pump allows you to program up to eight (8) different insulin sensitivities, if needed.</p>	BG units reduced / 1 unit of insulin	start time
	#1: _____	(midnight)
	#2: _____	
	#3: _____	
	(additional settings, if needed)	
	#4: _____	
	#5: _____	
	#6: _____	
	#7: _____	
	#8: _____	
<p>BG target: (your optimum BG value)</p> <p>range: 80 – 160 mg/dL or 4.4 - 8.9 mmol/L</p> <hr style="border: 1px solid blue;"/> <p>NOTE - Your pump will allow you to program up to eight (8) different BG targets, if needed.</p>	mg/dL (mmol/L)	start time
	#1: _____	(midnight)
	#2: _____	
	#3: _____	
	(additional settings, if needed)	
	#4: _____	
	#5: _____	
	#6: _____	
	#7: _____	
	#8: _____	

How the Bolus Wizard works

If you are going to eat and you want Bolus Wizard to estimate your food bolus: and/or	Enter your food intake (carbs or exch)
If you believe your BG is high and you want Bolus Wizard to estimate your correction bolus:	Enter your BG Reading <ul style="list-style-type: none">- automatically from the Paradigm Link meter (refer to the section, "Meter option")or- manually <hr/> <p>NOTE - <i>If you are using the Paradigm Link meter, you can program your pump to automatically receive your meter readings. The Bolus Wizard will use the BG reading when calculating your bolus amount. Refer to the section, "Meter option" in this chapter for instructions. (If you are not using this meter, you will manually enter your BG.)</i></p>

More about Bolus Wizard...

About high or low BG levels...

If your BG is less than 70 mg/dL (3.9 mmol/L), the screen will notify you and give instructions. Bolus Wizard programming will not continue. Read the instructions and press **ACT** or **ESC** to clear the message. The BOLUS MENU will appear. Exit the menus.

If your BG is more than 250 mg/dL (13.9 mmol/L), the screen will notify you and give instructions. Read the instructions and press **ACT** or **ESC** to clear the message. You can continue programming and deliver your bolus with Bolus Wizard.

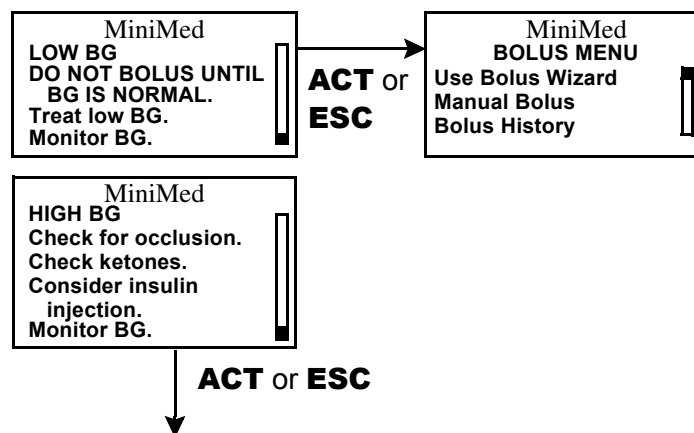

About maximum delivery

Bolus Wizard will not deliver more than the limit set for your maximum bolus. If Bolus Wizard calculates a bolus amount that is larger than your max bolus limit setting, the message, "MAX BOLUS EXCEEDED" will appear. If this happens, do these steps:

1. In the MAX BOLUS EXCEEDED screen, press **ACT** to continue your bolus programming. The estimate and maximum bolus amounts will appear for your information. Continue to step 2.

If you do not want to continue, press **ESC** to cancel and the screen will return to the ENTER BG screen.

2. In the EST: MAX screen, press **ACT** again to continue your bolus programming. If desired, press **ESC** to cancel and the screen will return to the ENTER BG screen.

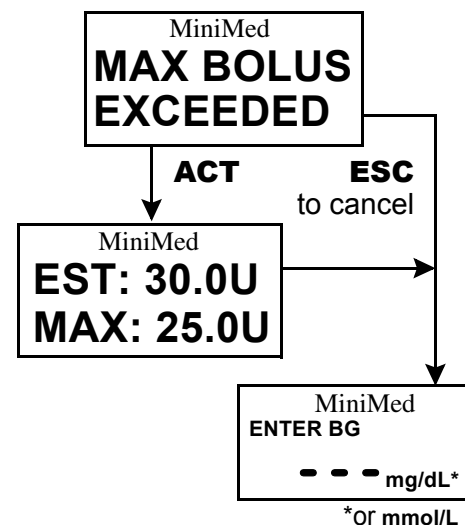

NOTE - Your pump will only deliver up to your maximum bolus limit setting.
For example: The Bolus Wizard estimate is 30 units and your max bolus limit is 25 units.
When you press **ACT**, your pump will only deliver 25 units.

About active insulin

Bolus Wizard will use your BG reading and/or your food intake to calculate a suggested bolus based on your personal settings (target BG, insulin sensitivity and carb ratio). Additionally, it will consider any active insulin still in your body from prior bolus insulin deliveries.

Four to six hours after a bolus, the majority of insulin has been absorbed, but a very small amount is active for a few more hours. The Bolus Wizard automatically calculates this for you and **subtracts** the appropriate amount. The details will appear in the ESTIMATE DETAILS screen during the bolus programming steps.

Be assured that the calculated bolus amount is a conservative estimate to avoid low BG. You can override the suggested Bolus Wizard estimate and manually enter a different amount.

ESTIMATE DETAILS	
Est total:	4.0U
Food intake:	45gr
(Meter) BG:	160
Food:	3.0U
Correction:	2.0U
Active Ins:	1.0U
ACT to proceed, ESC to back up	

If there is no active insulin, this will show "N/A"

(values shown are for example only)

How to program Bolus Wizard

You need your personal settings from the Bolus Wizard settings table to setup the Bolus Wizard. Your Bolus Wizard settings are programmed in the EDIT SETTINGS screen.

Main > Bolus > Bolus Wizard Setup > Edit Settings

Once the settings are programmed, you do not have to program them again unless the values change. After you program one setting, the screen will automatically go to the next required setting. After you program all your settings, review them as described in this section to make sure they are set correctly.

Instructions for programming the Bolus Wizard settings are in the next paragraphs. Program your settings in the order described to make sure you program all the settings.

Bolus Wizard on/off

1. Go to the EDIT SETTINGS screen.

Bolus > Bolus Wizard Setup > Edit Settings

2. Select **Wizard** and press **ACT**.

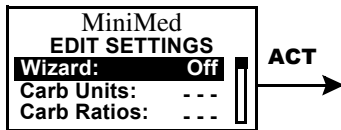

3. Select **On** or **Off** and press **ACT**.



4. The EDIT SETTINGS screen will appear. Press **ACT** to program your settings.

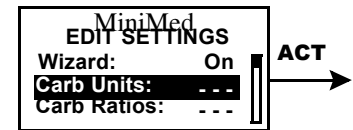

Carb units

The carb unit setting lets the pump know which way to count your carbohydrates (grams or exchanges). Refer to the "Bolus Wizard settings table" for your carb ratio settings.

NOTE - Any time you make changes to the carb units, you must also reprogram the carb ratios.

1. In the EDIT SETTINGS screen, select **Carb Units** and press **ACT**.

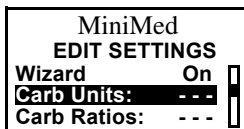

2. Select **Grams** or **Exchanges** and press **ACT**.

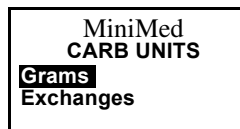

3. The screen will return to the EDIT SETTINGS screen so you can set your carb ratios next.



Carb/Exch ratios

If you use grams as your carb units: Carb ratio is the number of carb grams that are covered by one unit of insulin.
If you use exchanges as your carb units: Carb ratio is the number of insulin units that are needed to cover one (1.0) carb exchange.

Because this ratio may vary throughout the day, your pump allows you to set up to eight (8) settings. Your healthcare professional may only have you program one or two carb ratios when you first start using the Bolus Wizard feature.

4. In the EDIT SETTINGS screen, select **Carb Ratios** and press **ACT**.
5. The screen will change to SET CARB RATIO 1 (if you are using grams) or SET EXCH RATIO 1 (if using exchanges). Set your first ratio and press **ACT**.
 (The start time for your first ratio is midnight (12:00A) and cannot be changed.)

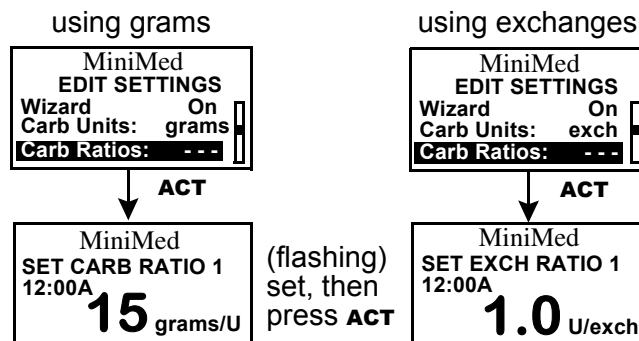

MiniMed
WARNING
 A carb ratio of XX is valid but outside the usual range of 5-50.*
 ESC to correct,
 ACT to continue

(* 0.3 - 3.0 for exch)

NOTE - Carb ratio values are normally between 5-50 grams/u or 0.3-3.0 u/exch. If your ratio value is outside the range, this warning message will appear on the screen. Press **ESC** to correct or **ACT** to continue.

6. To set just one ratio:	To set more than one carb ratio:
<p>a. Press ESC.</p> <div style="display: flex; justify-content: space-around;"> <div style="text-align: center;"> <p>using grams</p> <p>(flashing)</p> </div> <div style="text-align: center;"> <p>using exchanges</p> <p>(flashing)</p> </div> </div>	<p>a. Set the start time for ratio 2 and press ACT.</p> <p>b. Set the value for ratio 2 and press ACT.</p> <p>c. Repeat steps a and b to set more ratios.</p> <p>d. Press ESC when you are done.</p> <div style="display: flex; justify-content: space-around;"> <div style="text-align: center;"> <p>using grams</p> <p>(flashing) set then press ACT</p> </div> <div style="text-align: center;"> <p>using exchanges</p> <p>(flashing) set then press ACT</p> </div> </div> <p>* Depending on how many ratios you set, this number can be 2 through 8.</p>

- The screen will return to the EDIT SETTINGS screen. Set your BG Units as described in the next section.

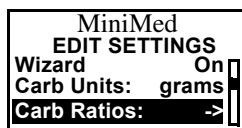

BG units

You can select **mg/dL** or **mmol/L** as your Blood Glucose Unit (measurement type).

NOTE - If you make changes to your BG units setting, you must reprogram your insulin sensitivity and BG targets.

- In the EDIT SETTINGS screen, select **BG Units** and press **ACT**.

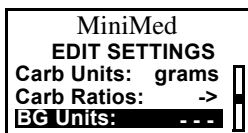

- Select **mg/dL** or **mmol/L** and press **ACT**.

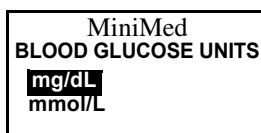

- The screen will return to the EDIT SETTINGS screen to set your insulin sensitivity next.

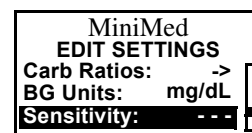

Insulin sensitivity

Your insulin sensitivity is the amount your blood glucose (BG) level is reduced by one unit of insulin. This value is used to calculate a suggested insulin dose to correct a high BG. Because this amount may vary throughout the day, your pump lets you set up to eight (8) sensitivity settings. Your healthcare professional may only have you program one or two ins sensitivities when you first start using the Bolus Wizard feature. Record your settings in the “Bolus Wizard settings table.”

Insulin sensitivity values are normally between 20 – 100 mg/dL (or 1.1 – 5.6 mmol/L). If your value is outside this range, a warning message will appear on the screen.

- In the EDIT SETTINGS screen, select **Sensitivity** and press **ACT**.
- Enter the value for the first insulin sensitivity setting and press **ACT**.

NOTE - The start time for your first **INS SENSITIVITY** is midnight (12:00A) and cannot be changed.

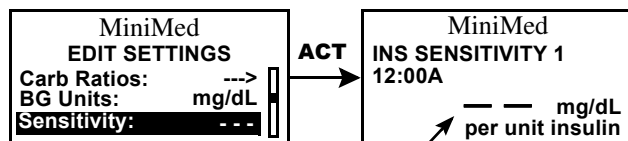

(flashing) set, then press **ACT**

3. The SET START TIME 2 screen will appear.

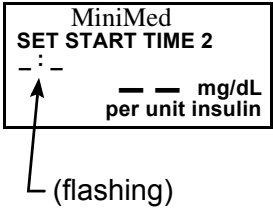
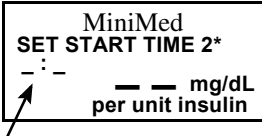
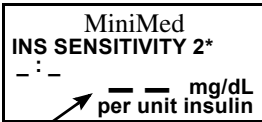
To set just one ins sensitivity:	To set more than one ins sensitivity:
<p>Press ESC.</p> 	<p>a. Set the start time for ins sensitivity 2 and press ACT.</p>  <p>(flashing) set, then press ACT</p> <p>b. Set the value for ins sensitivity 2 and press ACT.</p>  <p>(flashing) set, then press ACT</p> <p>c. Repeat steps a and b to set more values.</p> <p>d. Press ESC when you are done.</p> <p><i>* Depending on how many values you set, this number can be 2 through 8.</i></p>

4. The screen will return to the EDIT SETTINGS screen. You can now program your BG targets.

BG targets

The BG target setting allows you to set your pre-meal blood glucose targets. Because this amount may vary throughout the day, your pump allows you to set up to eight (8) BG targets. Your healthcare professional may only have you program one or two BG targets when you first start using the Bolus Wizard feature.

NOTE - BG targets are normally between 90 - 140 mg/dL (or 5.0 - 7.8 mmol/L). If your targets are outside this range, a warning message will appear on the screen.

- In the EDIT SETTINGS screen, select **BG Targets** and press **ACT**.
- Enter your first BG target and press **ACT**.



NOTE - The start time for your first target BG is midnight (12:00A or 00:00) and cannot be changed.

3. To set just one BG Target:	To set more than one BG Target:
<p>a. Press ESC.</p> <div data-bbox="404 153 640 268" style="border: 1px solid black; padding: 5px; margin: 10px auto; width: fit-content;"> MiniMed SET START TIME 2 --:-- -- -- mg/dL </div> <p style="margin-left: 100px;">(flashing) press ESC</p>	<p>a. Set the start time for BG Target 2 and press ACT.</p> <div data-bbox="1172 153 1407 268" style="border: 1px solid black; padding: 5px; margin: 10px auto; width: fit-content;"> MiniMed SET START TIME 2* --:-- -- -- mg/dL </div> <p style="margin-left: 100px;">(flashing) set, then press ACT</p> <p>b. Set the value for Target BG 2 and press ACT.</p> <div data-bbox="1172 379 1407 494" style="border: 1px solid black; padding: 5px; margin: 10px auto; width: fit-content;"> MiniMed SET TARGET BG 2* --:-- -- -- mg/dL </div> <p style="margin-left: 100px;">(flashing) set, then press ACT</p> <p>c. Repeat steps a and b to set more BG Targets.</p> <p>d. Press ESC when you are done.</p> <p style="text-align: right;"><i>* Depending on how many targets you set, this number can be 2 through</i></p>

4. The screen will display one of these messages:

MESSAGE

What it means

- ➡ "Bolus Wizard setup is complete"Bolus Wizard is on and all settings are programmed.
- ➡ "Bolus Wizard is off"Bolus Wizard is off.
- ➡ "Missing Info"Bolus Wizard is on, but some of the settings are not programmed. This screen will show instructions and the missing information. You must program the missing information before you can use the Bolus Wizard.

Review your Bolus Wizard settings

Check your Bolus Wizard settings in the REVIEW SETTINGS screen. If necessary, compare this information with your information in the Bolus Wizard settings table.

Bolus > Bolus Wizard Setup > Review Settings

1. In the REVIEW SETTINGS screen, scroll through the text to view your Bolus Wizard settings.
2. If an arrow appears next to an item, that item has more than one setting. You can review these settings.
 - a. Select the item and press **ACT**.
All the settings for that item will appear.
 - b. Scroll through the settings for that bolus setting.
3. Exit the menus when you are done.

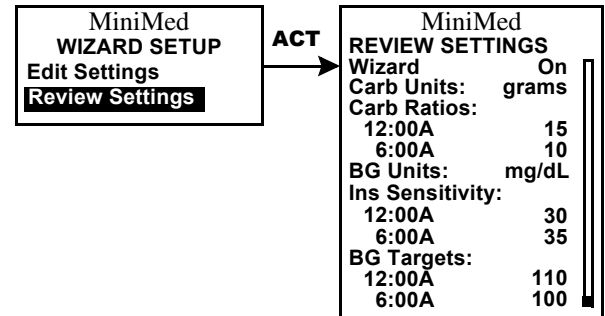

Meter option

You can setup your pump to automatically receive your BG reading from the Paradigm Link meter. This meter may not be available in all countries. Check with your local Medtronic MiniMed representative. Your pump is set at the factory with the meter option turned off. Programming your Paradigm Link meter ID, links your pump to the meter. If you do not "link" the meter to your pump, you will enter your BG readings manually. Each Paradigm Link meter has its own unique ID. You can link up to three (3) meters to your pump.

When the pump is idle (at the HOME screen), it will beep or vibrate when it receives a BG reading from the Paradigm Link meter. The reading will appear on the pump screen.

NOTE - *The use of RF (radio frequency) devices with the pump reduces pump battery life.*

You have to turn on the meter option to add, delete or review the meter ID(s) programmed in your pump. The meter ID is the serial number printed on the back of the Paradigm Link meter. See the user guide that came with your Paradigm Link meter for detailed information on how to use it.

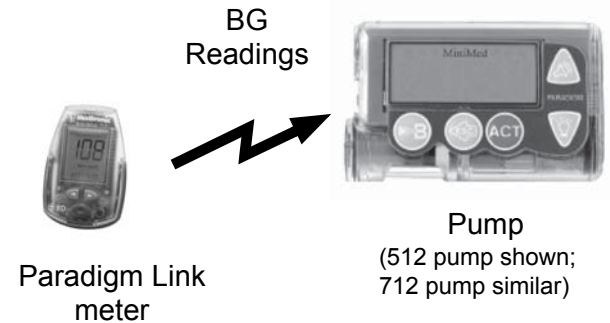

Meter rules

If you want your pump to communicate with the Paradigm Link meter, the following conditions must apply:

1. The meter option must be turned on and programmed. Refer to the instructions in this section.
2. Your pump must be within 4 feet (1.22 meters) of your Paradigm Link meter to receive the BG reading.
3. The pump cannot have a LOW BATTERY alert condition.
4. When programming a bolus, the BG measurement from the Paradigm Link meter will appear as the default BG value in the ENTER BG screen. The pump will not display a reading that is older than 12 minutes.
5. Make sure the pump's Meter Option is set to "Off" while on board aircraft.
6. Do not use the RF meter to send your BG readings to the pump while on board aircraft. Manually enter your BG.

CAUTION: The pump will not receive signals from the Paradigm Link meter while it has a "Low Battery" condition. To ensure the meter communicates with the pump, make sure the pump does not have a low battery. (Replacing the low battery with a new battery will restore meter-pump communication.)

Add, delete, review meter IDs

The meter programming screens are very similar to those for the remote control. Make sure to select "Meter Options" (in the UTILITIES MENU) when programming your Paradigm Link meter.

If you are not sure that your Paradigm Link meter ID is entered in your pump, check the REVIEW METER ID screen.

You have to turn on the meter option to add, delete or review the Paradigm Link meter ID(s) programmed in your pump.

Main > Utilities > Meter Options

1. In the METER OPTION screen, select **On** and press **ACT**. The METER ID MENU will appear.

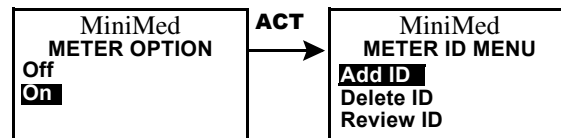

2. Add, delete or review your meter ID(s) as desired.

Add	Delete	Review
<p>a. Select Add ID and press ACT.</p> <p>b. Enter each of the six ID numbers. Press ACT after each entry.</p> <div data-bbox="248 336 626 464" style="border: 1px solid black; padding: 5px; margin: 10px 0;"> <p style="text-align: center;">MiniMed ADD METER ID</p> <p style="text-align: center;">----- (flashing)</p> </div> <p>c. After you set the last number of the ID, the screen will return to the METER ID MENU.</p> <div data-bbox="241 632 485 767" style="border: 1px solid black; padding: 5px; margin: 10px 0;"> <p style="text-align: center;">MiniMed METER ID MENU</p> <p>Add ID Delete ID Review ID</p> </div>	<p>a. Select Delete ID and press ACT.</p> <p>b. Select the meter ID that you want to delete and press ACT.</p> <div data-bbox="720 336 964 464" style="border: 1px solid black; padding: 5px; margin: 10px 0;"> <p style="text-align: center;">MiniMed DELETE METER ID</p> <p>1 111111 2 222222 3 -----</p> </div> <p>c. The selected ID is now deleted.</p> <div data-bbox="720 560 964 687" style="border: 1px solid black; padding: 5px; margin: 10px 0;"> <p style="text-align: center;">MiniMed DELETE METER ID</p> <p>1 ----- 2 222222 3 -----</p> </div>	<p>a. Select Review ID and press ACT.</p> <p>b. The programmed IDs will show in the REVIEW METER ID screen.</p> <div data-bbox="1231 336 1475 464" style="border: 1px solid black; padding: 5px; margin: 10px 0;"> <p style="text-align: center;">MiniMed REVIEW METER ID</p> <p>1 ----- 2 222222 3 -----</p> </div>

3. Exit the menus when your are done.

Normal bolus using Bolus Wizard

After the Bolus Wizard is turned on and the settings are programmed, Bolus Wizard can calculate an estimate of insulin you need for your **correction bolus** and/or your **food bolus**. You have the option of using the estimate or changing it as necessary. Additionally, your pump can receive your BG reading from the Paradigm Link meter, if they are linked.

Use  to deliver a Normal bolus at any time except during another Normal bolus. A Normal bolus will temporarily interrupt a Square Wave or Dual Wave bolus that is delivering. After the Normal bolus is finished, the Square Wave or Dual Wave bolus delivery will resume.

NOTE - If you want to use the pump-to-meter link, make sure the meter option is on. Refer to the section, "Meter option" for instructions.

1. If you want a correction bolus, check your BG with your BG meter and go to step 2.
If you want to bolus for food, go to step 2.
2. Press  on your pump, or go to the BOLUS MENU, select **Use Bolus Wizard**, and press **ACT**.
3. The ENTER BG screen will appear.

If you are NOT using the Paradigm Link meter:	If you are using the Paradigm Link meter:
<p>Enter your BG value. Press ACT and continue to step 4.</p> <p>If you are not entering a BG and want to bolus for food, select the dashes in the ENTER BG screen. Press ACT and continue to step 4.</p> <div data-bbox="551 884 782 1023" style="border: 1px solid black; padding: 5px; width: fit-content; margin: 10px auto;"> <p style="text-align: center;">MiniMed ENTER BG - - - mg/dL* *or mmol/L</p> </div> <p>NOTE - Selecting dashes in this screen will make Bolus Wizard calculate the insulin needed for your food entry without considering your BG level.</p>	<p>The meter reading will flash on the pump screen. Press ACT to accept this amount. (You can change this BG value, if necessary.) Continue to step 4.</p> <div data-bbox="1278 794 1522 938" style="border: 1px solid black; padding: 5px; width: fit-content; margin: 10px auto;"> <p style="text-align: center;">MiniMed ENTER BG meter XXX mg/dL* *or mmol/L</p> </div> <p>NOTE - You must program your bolus within 12 minutes of the pump receiving the reading from the meter. If more than 12 minutes have passed, the reading will no longer be available from the screen and you must enter your BG manually.</p>

4. In the ENTER FOOD screen,

if this is a food bolus:	if this is a correction bolus:
enter the food value you will eat and press ACT . 	select 0 (zero) as the value and press ACT .

5. Review the information in the ESTIMATE DETAILS screen. Press **ACT** to continue to step 6. If you need to make any changes, press **ESC** to return to the ENTER BG screen (step 3) and make changes as necessary.

ESTIMATE DETAILS	(values shown are for example only)
Est total:	4.0U
Food intake:	45gr
(Meter) BG:	160
Food:	3.0U
Correction:	2.0U
Active Ins:	1.0U
ACT to proceed, ESC to back up	

ESC returns to the ENTER BG screen

6. In the SET BOLUS screen, the estimated bolus amount will show (flashing). Change the amount if desired. Press **ACT** to accept.

ACT
to continue

MiniMed	SET BOLUS	ESTIMATE	4.0u
---------	-----------	----------	------

ACT
to accept

7. Press **ACT** to accept and deliver the bolus. The BOLUS DELIVERY screen will appear. The pump will beep or vibrate at the start and end of the bolus. As the bolus is delivered, the screen will show the bolus type and amount until the total units have been delivered. The screen will then default to the HOME screen.

MiniMed	BOLUS DELIVERY	3:24P	NORMAL	0.1u
---------	----------------	-------	--------	------

Bolus Wizard examples

For the scenarios that follow, Michael has his Bolus Wizard turned on with the following settings:

Carbratio: 15 grams per unit of insulin
Insulin Sensitivity: 40 mg/dL per unit of insulin
Target BG: 120 mg/dL

Example #1: Bolus Wizard, BG on target (normal BG)

Michael awakens in the morning before school and his mother has breakfast waiting for him. Before he begins eating, he tests his blood glucose with his Paradigm Link meter and his BG result of 120 mg/dl is automatically sent to his pump.

He estimates that his meal consists of 60 grams of carbohydrate. When prompted by Bolus Wizard, he enters this amount in the ENTER FOOD screen. Based on his Bolus Wizard settings, the pump will suggest that he take 4.0 units of insulin.

Example #2: Bolus Wizard, BG above target (high BG)

The next day, Michael wakes up before school. Before eating the same breakfast, he tests his BG with his Paradigm Link meter and finds it to be above his target at 200 mg/dL. His BG reading is automatically sent to his pump.

When prompted by Bolus Wizard, he enters his carbohydrate amount of 60 grams in the ENTER FOOD screen. Based on his settings, the pump will suggest that he take 6.0 units of insulin.

(4.0 for carbohydrate **plus** 2.0 to correct his elevated BG).

**Example #3: Bolus Wizard,
Blood glucose below target (low BG)**

On another morning, Michael sits down before eating the same breakfast. He tests his BG with his Paradigm Link meter and finds it at 80 mg/dL, which is below his target. His reading is automatically sent to his pump.

When prompted by Bolus Wizard, he enters his carbohydrate amount of 60 grams in the ENTER FOOD screen. Based on his settings, the pump will suggest that he only take 3.0 unit of insulin.

(4.0 for food **minus** 1.0 to correct his BG that is lower than target).

**Example #4: Bolus Wizard,
Blood glucose above target (high BG) with active insulin**

Michael is at school and wants to eat a snack in the late morning. He tests his BG with his Paradigm Link meter and finds it to at 200 mg/dl, which is above his target. He estimates that his snack contains 60 grams of carbohydrate, so he enters 60 into the pump when prompted by the Bolus Wizard. Based on his settings, and as a result of 1.5 units of active insulin, his pump will suggest that he take 4.5 units.

(4.0 for food **plus** 2.0 to correct his elevated BG, **minus** 1.5 units of active insulin).

Square Wave and Dual Wave bolus

Square Wave bolus delivers a bolus evenly over a specified period of time (30 minutes to 8-hours). This bolus can be used for insulin delivery when you have eaten a long meal with extended snacking. It can also be useful if you have delayed food digestion due to gastroparesis or meals high in fat. A Square Wave bolus can be useful if a Normal bolus drops your BG too rapidly. Since the Square Wave portion extends over a period of time, the insulin is more likely to be available to match your individual needs.

Dual Wave bolus delivers a combination of an immediate Normal bolus followed by a Square Wave bolus. The Square Wave portion is delivered evenly over a period of time. A Dual Wave bolus is useful for meals with both rapidly and slowly absorbed carbohydrates. For example, a Dual Wave bolus would be appropriate for fruit and crackers followed by pasta. The Dual Wave option meets both immediate and extended insulin needs. A Dual Wave bolus is also useful for correcting elevated blood glucose before a meal.

Dual Wave/Square Wave bolus on-off

NOTE - *It is important that you consult with your healthcare professional before using a Square Wave or Dual Wave bolus. You should be familiar with the basic functions of your pump before exploring these options.*

To set up a Dual Wave or Square Wave bolus, you must first turn on the dual/square bolus option. If the option is off, a Dual Wave or Square Wave bolus cannot be programmed or delivered.

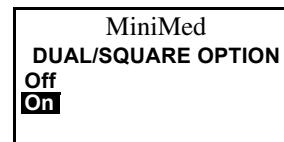

1. Go to the DUAL/SQUARE OPTION screen.
Main > Bolus > Dual/Square Bolus
2. Select **On** and press **ACT**. The feature is now on. Exit the menus.



Square Wave or Dual Wave bolus without Bolus Wizard

NOTE - To deliver a Square Wave or Dual Wave bolus, the dual/square bolus option must be on.

1. Make sure the dual/square option is on.
2. Calculate your food and/or correction bolus amount.
3. Press  on your pump, or go to the BOLUS MENU and select **Set Bolus** (or **Manual Bolus**), then press **ACT**.
4. The BOLUS TYPE (or MANUAL BOLUS TYPE) screen will appear.

For a Square Wave bolus do these steps:	For a Dual Wave bolus do these steps:
<p>a. Select Square Wave Bolus. Press ACT. The SET SQUARE BOLUS screen will appear.</p> <p>b. Enter the desired amount for the Square Wave bolus units and press ACT.</p> <div style="border: 1px solid black; padding: 5px; width: fit-content; margin: 10px auto;"> <p style="text-align: center;">MiniMed SET SQUARE BOLUS 1.2U</p> </div> <p>c. Continue to step 5.</p>	<p>a. Select Dual Wave Bolus and press ACT. The SET DUAL BOLUS TOTAL screen will appear.</p> <p>b. Enter the desired amount for the total dual bolus units. Press ACT.</p> <div style="border: 1px solid black; padding: 5px; width: fit-content; margin: 10px auto;"> <p style="text-align: center;">MiniMed SET DUAL BOLUS TOTAL 1.2U</p> </div> <hr style="width: 50%; margin: 10px auto;"/> <p>NOTE - The number of units you enter for the SET DUAL BOLUS TOTAL is a total of both the Normal and Square Wave bolus units.</p> <p>c. In the next screen, press  /  to change the normal (Now) and Square portions of the Dual Wave bolus. Press ACT. Notice the screen also shows the percentage amount for each portion.</p> <div style="border: 1px solid black; padding: 5px; width: fit-content; margin: 10px auto;"> <p style="text-align: center;">MiniMed</p> <p style="text-align: center;">Now: 0.6U</p> <p style="text-align: center;">Square: 0.6U</p> <p style="text-align: center;">50% 50%</p> <p style="text-align: center;">↓ ACT</p> </div> <p>d. Continue to step 5.</p>

5. The SQUARE DURATION screen will appear. Enter the amount of time you want the Square Wave bolus to last and press **ACT**.
6. The BOLUS DELIVERY screen will appear. The pump will beep or vibrate at the start and end of the bolus. As the bolus is delivered, the screen will show the bolus type and amount until the total units have been delivered. The screen will then default to the HOME screen.

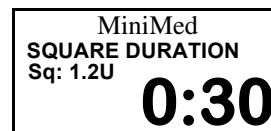

**Example #1: Square Wave bolus,
Use of a Square Wave bolus while eating a meal high in fat**

Conner loves pizza. When he was using insulin shots, he began to avoid pizza because he always had high blood glucose readings several hours after eating this high fat meal. Now that Conner is using the Paradigm pump, he can use the Square Wave bolus feature to help with this problem. With frequent blood glucose testing and many pizza meals, he and his healthcare professional have determined the length of time (duration) he needs to set his Square Wave bolus to prevent the high blood sugars after eating pizza. He set it for 3-hours.

**Example #2: Square Wave bolus,
(gastroparesis)**

Lisa has had diabetes for many years. She has been diagnosed with gastroparesis, a condition of the digestive system that slows down the emptying of food from her stomach. This makes her carbohydrate digestion unpredictable. Because of this, Lisa has had a lot of trouble with blood glucose control. It has been suggested to her that she use the Square Wave bolus feature before meals to more evenly match her insulin with her carbohydrate digestion.

**Your turn:
Square Wave bolus practice**

Your target pre-meal blood glucose range is _____ to _____.

Check your pre-meal blood glucose. Are you within your target? ____ If yes, continue. If no, wait to try the following test until your pre-meal blood glucose is within your target range:

TEST: Choose a meal that is high in fat (e.g. hot dogs, pizza, cheese enchiladas). Determine your meal bolus amount. Set the Square Wave bolus to deliver the determined amount of insulin over 2-hours*.
(* This duration time is an example. As always, consult with your healthcare professional for guidance.)

Check your BG (blood glucose) and record:

Pre-meal	_____
1 hour post meal	_____
2 hours post meal	_____
3 hours post meal	_____
4 hours post meal	_____

Did your blood glucose return to your pre-meal target within 4 hours post meal? _____*

- * If you answered yes, then repeat this test with the same meal on another day to verify your results.
- * If you answered no, discuss this with your healthcare professional for guidance.

Example #1: Dual Wave bolus

Set a Dual Wave bolus for a barbecue style dinner

Carol is going to a barbecue at a friend's house. Her meal consists of:

mixed green salad
potato salad

fruit salad
baked beans

a dinner roll and margarine
pork ribs with barbecue sauce.

She calculates her total carbohydrates and determines her total meal bolus amount. She knows that she will need some insulin immediately for the fruit, barbecue sauce and dinner roll and some insulin spread out over time for the high fat and high fiber content of the rest of the meal. Carol will program her pump to deliver a Dual Wave bolus with $\frac{1}{2}$ of the total bolus to be given immediately and the other half over a 2- hour* duration.

(* This particular duration of time and bolus proportions is an example. As always, you should consult with your healthcare professional for your individual needs.)

Example #2: Dual Wave bolus,

Set a Dual Wave bolus for correcting elevated BG before a meal

Marsha uses the Square Wave bolus for the majority of her meals. She tests her pre-meal BG and finds that it is above her target level. Marsha would like to correct her elevated blood glucose before she eats. The Dual Wave bolus can be used to deliver some insulin now to help correct her blood glucose elevation, and then deliver her Square Wave bolus to cover her meal.

Your turn:
Dual Wave bolus practice

Can you think of any meals where this feature would help you with blood glucose control?

Your target pre-meal blood glucose range is _____ to _____

Check your pre-meal blood glucose. Are you within your target? ____ If yes, continue. If no, try this test when your pre-meal blood glucose is within your target range:

TEST:

Choose a meal that has a combination of both rapidly absorbed and slowly absorbed carbohydrates. Determine your meal bolus amount. Set the Dual Wave bolus to deliver the determined amount of insulin. Program your pump to deliver $\frac{1}{2}$ over 2-hours*, and the other half immediately.

(* This duration of time and ratio is an example. As always, consult with your healthcare professional for guidance.)

Check blood glucose and record:

Pre-meal_____

1 hour post meal_____

2 hours post meal_____

3 hours post meal_____

4 hours post meal_____

Did your blood glucose return to your pre-meal target within 4 hours post meal? _____*

- * If you answered yes, then repeat this test with the same meal on another day to verify your results.
- * If you answered no, discuss this with your healthcare professional for guidance.

Using Bolus Wizard for a Square Wave or Dual Wave bolus

If you are using Bolus Wizard to calculate your Square Wave or Dual Wave bolus amounts, you will be prompted to enter your BG reading and/or the (carb or exchange) units you will eat. Bolus Wizard will use this input to calculate your suggested correction and/or food bolus amount. If you do not want to use the Bolus Wizard estimate, you can change it, if desired.

1. Bolus Wizard must be turned on and the settings must be programmed. Also, make sure the dual/square option is turned on.

NOTE - If you want to use the pump-to-meter link, make sure the meter option is on. Refer to the section, "Meter option" for instructions.

2. After you enter your BG and/or food entry, review the information in the ESTIMATE DETAILS screen. Press **ACT** to continue to step 3. If you need to make any changes, press **ESC** to return to the ENTER BG screen and make changes as necessary.

ESTIMATE DETAILS	
Est total:	4.0U
Food intake:	15gr
(Meter) BG:	12.60
Food:	3.0U
Correction:	2.5U
Active Ins:	1.5U
ACT to proceed, ESC to back up	

(values shown are for example only)

3. In the next screen, select **Square Wave Bolus** or **Dual Wave Bolus** as desired and press **ACT**.

(using Bolus Wizard)

MiniMed
BOLUS EST: 4.0U
Normal Bolus
Square Wave Bolus
Dual Wave Bolus

ACT

(without Bolus Wizard)

MiniMed
BOLUS TYPE
Normal Bolus
Square Wave Bolus
Dual Wave Bolus

ACT

NOTE - If you are using Bolus Wizard and it calculates that your bolus includes a portion to correct your high BG, the Square Wave bolus will not be available. This helps you to select a bolus type (Normal or Dual Wave) that has an immediate delivery option to cover your high BG.

MiniMed
BOLUS EST: 4.0U
Normal Bolus
Dual Wave Bolus



4. For a **Square Wave** bolus do these steps:

The SET SQUARE BOLUS screen will appear. Change the amount if desired. Press **ACT** to accept. Go to step 5.

For a **Dual Wave** bolus do these steps:

NOTE - The number of units you program for the SET DUAL BOLUS TOTAL is a total of both the Normal and Square Wave bolus units.

a. The SET DUAL BOLUS TOTAL screen will appear. Change the amount if desired. Press **ACT** to accept.

b. In the next screen, notice the screen shows the Normal (Now) and Square portions of the Dual Wave bolus. Press **ACT** to accept the portions suggested by Bolus Wizard, or press  /  to change these portions then press **ACT**.

NOTE - Bolus Wizard splits the food portion of your bolus 50/50 between the Square and Now portions. The entire correction amount is always recommended to the Now portion. In this example the Now portion consists of half of the food insulin plus the correction amount less the active insulin ($1.5U + 2.5U - 1.5U$). This gives 2.5U or 62% of total insulin of 4.0U.

5. The SQUARE DURATION screen will appear. Enter the amount of time you want the Square Wave bolus to last and press **ACT**.

6. Press **ACT** to accept and deliver the bolus. The BOLUS DELIVERY screen will appear. The pump will beep or vibrate at the start and end of the bolus. As the bolus is delivered, the screen will show the bolus type and amount until the total units have been delivered. An open circle will appear indicating that your pump is in Special mode. If you want to see the progress of the delivery, press ESC to see the STATUS screen.

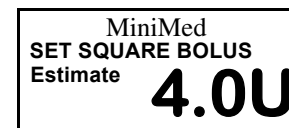

ACT

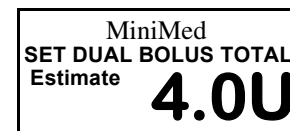

ACT

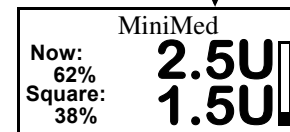

ACT

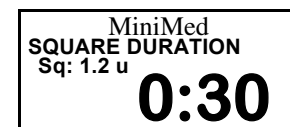

ACT



ACT



Easy bolus

The EASY BOLUS button  allows a quick way to deliver a Normal bolus. You will pre-set the settings for this feature in the EASY BOLUS OPTION screen in the BOLUS MENU. Your pump is sent from the factory with the Easy Bolus feature set to on. If you do not want to use Easy Bolus, turn it off.

NOTE - *If you are using the remote control, the Easy Bolus must be set to on.*

After you setup Easy Bolus, with each  press, you can increase the Normal bolus amount by a fixed amount, called a “step.” Before you can deliver an Easy Bolus, you must set the amount in the EASY BOLUS ENTRY screen. This amount equals the number of units of insulin for each step. The maximum number of steps is 20 and can be up to your maximum bolus limit.

Once you set your step amount, you can program your Easy Bolus. When you are in the HOME screen, each time you press  the Easy Bolus amount increases by one “step.” You will hear a beep or feel a vibration for each step increase. Each beep is a different tone. This makes it easy for you to count the beeps while you are programming your Easy Bolus.

Easy bolus setup

1. Go to the EASY BOLUS OPTION screen.

Main > Bolus > Easy Bolus

Select **On/Set** and press **ACT**. If you do not want to use Easy Bolus, select **Off** and press **ACT**.



Step value setup

You can set the step value from 0.1 to 2.0 units (factory setting: 0.1). Set the step to a number that is convenient to use and easy to multiply. The maximum number of steps is 20 up to the maximum bolus limit, whichever occurs first.

2. In the EASY BOLUS ENTRY screen, the “step” value will appear flashing. Change the value and press **ACT** (The step value is the increment you will use for your Easy bolus.)
3. The screen will return to the BOLUS MENU. Your step amount is now programmed and Easy Bolus is ready to use. Exit the menus.

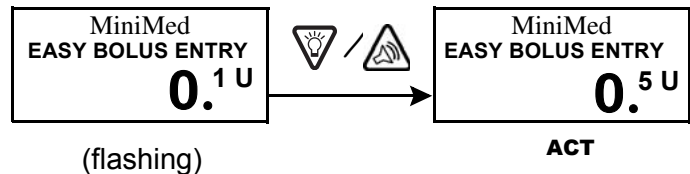

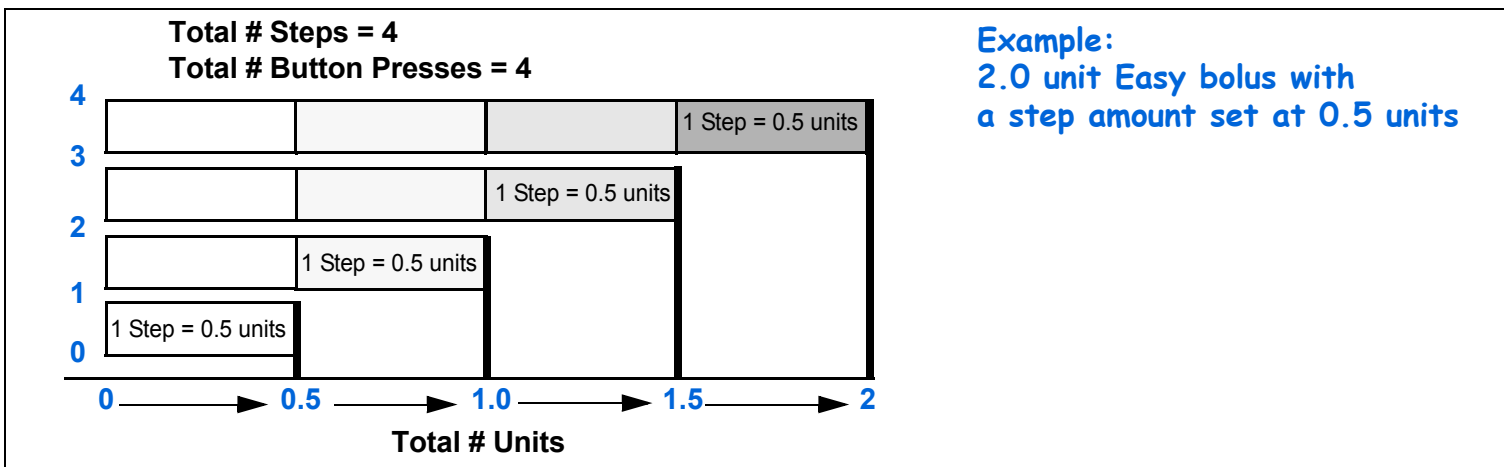

Deliver Easy Bolus

Practice using the Easy Bolus feature while looking at the pump screen as you count the beeps. After you are familiar with Easy Bolus, you can use the audible tones for bolus delivery without having to look at the screen.

NOTE - Easy bolus only works from the HOME screen.

- From the HOME screen, press . The SET EASY BOLUS screen will appear. The single "step" value will be flashing.
- Press the number of times needed for your bolus amount. Watch the amount change on the screen with each press. When your total bolus amount appears on the screen, press **ACT**. The pump will vibrate or sound a different tone for each press. Listen/feel to count the steps without looking at the screen.

For example: You need to deliver a 1.0 unit bolus, and your step size is set to 0.1.

Each time you press , the units increase by the "step" amount.

To deliver 1.0 units, you need to press the button 10 times. ($10 \times 0.1 = 1.0$)

The screen will show 1.0 units.

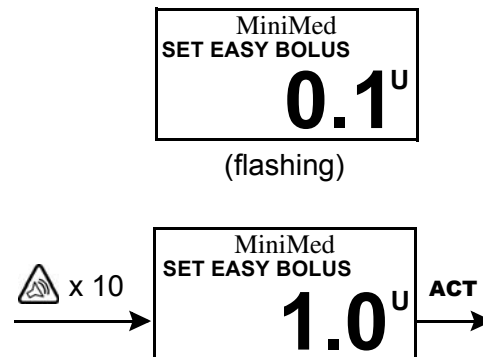

NOTE - Pressing or **ESC** will cancel the Easy bolus.

3. If this amount is correct, press **ACT** to start the Easy Bolus delivery. The BOLUS DELIVERY screen will show the units being delivered. When the total bolus is finished, the pump will beep or vibrate.

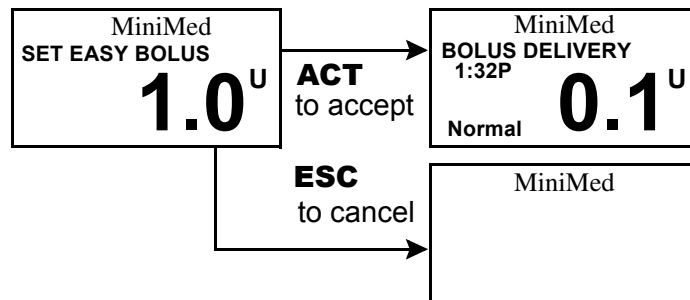

If this amount is wrong, press **ESC** or  to start over. The pump will return to the HOME screen.



Example #1: Easy bolus

Alexander is a busy executive with an accounting firm. He wears his Paradigm pump on his belt and does not want to take it off to give himself a bolus. Alex can easily reach down and feel for the Easy Bolus button  to give a bolus.

He previously programmed his pump to deliver an Easy Bolus in steps of 0.5 unit increments. From the HOME screen, with each press of the , the pump will sound a different tone so he can keep track of the number of button presses.

He wants to give himself 2.0 units for a snack, so he will press  4 times (4 presses x 0.5 units/press = 2.0 units) and then press the **ACT** button. The pump counts back 4 beeps because he pressed  4 times. He simply presses **ACT** to confirm the amount, and his pump delivers the 2.0 units.

When Alexander wants to be more discrete, or does not want his pump to beep in an important meeting, he can set the pump to “vibrate” mode (see section. “Alert types”) and feel for vibrations rather than listening for the tones.

Your turn: Easy bolus practice

The factory default setting for the Easy Bolus feature is 0.1 unit steps. You can change the step level as necessary to a value that is more convenient for you to use and easier to multiply.

Give your next bolus by using the Easy Bolus feature on your pump.

How many units did you give? _____

How many tones did you count? _____

It might be a good idea to look at your pump's screen to see the bolus amount as well as counting the steps the first few times you try this until you become familiar and comfortable with the feature.

Your step level is _____.

Basal patterns

The Basal Patterns feature is optional for pump users. You can set your pump to deliver a standard basal and two additional basal patterns to meet your individual daily, weekly, or monthly needs. Keep a paper copy of your programmed patterns with you at all times in case you need to reprogram your pump. To select and use pattern A or pattern B, the patterns option must be on and programmed.

Basal patterns are useful to establish different sets of basal rates to match different needs such as:

- Changes in time of sleep (for example, work shift)
- Different schedules during the week versus weekend
- Extended periods of higher or lower activity
- Softball games every Saturday morning, etc.
- Menses

NOTE - *You may want to explore this option after you become familiar with the basic pump functions. It is important that you consult your healthcare professional before using a pattern other than your standard pattern.*

- **Standard pattern:** Your normal basal that supports your usual day-to-day activity. When the Patterns feature is off, the pump uses your standard basal pattern.
- **Pattern A/B:** Basal pattern that supports activity levels that are not a part of your day-to-day routine, but are normal in your lifestyle. Such activities could be a sport that you do once a week or a change in your sleep pattern over the weekend.

Patterns on/off

Your pump is set at the factory with the basal patterns feature turned off. After you turn on patterns, you still have to program and select a pattern (A or B), as described in the next sections, before the patterns feature is active. If you turn off the patterns feature, your pump will automatically select your standard basal pattern.

1. Go to the PATTERNS OPTION screen.

Main > Basal > Patterns

Select **On** or **Off** and press **ACT**.

2. The screen will go back to the BASAL MENU. The patterns feature is now on. Exit the menus.



Program a pattern

Your pump will keep your pattern settings even when the Patterns option is turned off. The patterns feature must be on to program a basal pattern.

NOTE - Be aware. When you make changes to a pattern, the pump will use that pattern as the current basal. Make sure the basal you want is selected in the **SELECT PATTERNS** screen.

Do these steps to program your patterns:

1. Go to the EDIT BASAL screen.

Main > Basal > Set/Edit Basal

2. Select the basal pattern you want to program and press **ACT**.

3. The SET BASAL RATE 1 screen will appear. The basal rate will flash indicating that it can be changed. Set your first rate and press **ACT**.

NOTE - The first basal rate starts at midnight and cannot be changed.

4. The SET START TIME 2 screen will appear. The start time will flash. If you want to use the same rate for the whole day, press **ESC** and go to step 5.

If you want to program more rates, do these steps:

- a. Set the start time for this rate and press **ACT**.
- b. The rate will start flashing. Set the rate and press **ACT**.
- c. Repeat steps a and b for each additional rate you want to program for that pattern. Each rate will have a different number (RATE 2, RATE 3, etc.). Press **ESC** when you are done. Continue to step 5.

5. After you press **ESC**, the BASAL RATE screen appears. The screen will show:

- ▶ the current basal pattern and basal rate,
- ▶ time it started, and
- ▶ the 24-hour basal total.

MiniMed
EDIT BASAL
Standard 16.80 U
Pattern A ---- U
Pattern B ---- U

ACT

MiniMed
SET BASAL RATE 1
12:00A
A ---- U
H

rate
(flashing)

Indicates programming is for Pattern A

MiniMed
SET START TIME 2
---- U
H

time
(flashing)

MiniMed
SET START TIME 2
---- U
H

Set time
(flashing)

MiniMed
SET BASAL RATE 2
07:30A
---- U
H

rate will flash after
you set the start time.

○○○ MiniMed ○○○
BASAL RATE A
Current Rate 0.80 U/H
Started #1 -12:00A
24 Hr. Total 19.20

Indicates
Pattern A is the
active pattern.

Select a pattern

Before you try to select a pattern, make sure the Patterns feature is on. After your standard pattern and/or pattern A or B are set, do these steps to select a pattern:

1. Go to the SELECT PATTERNS screen.
Main > Basal > Select Patterns
2. Select the desired pattern, press **ACT**.
3. The screen will return to the BASAL MENU. Your basal pattern is now active. Exit the menus.

NOTE - If pattern A or B is active, the pump is in "Special mode" (open circles appear across the top of the screen).

MiniMed	
SELECT PATTERNS	
Standard	16.80 U
Pattern A	19.60 U
Pattern B	- - - - U

ACT

← this pattern is not programmed.

○○○	MiniMed	○○○
BASAL MENU		
Set/Edit Temp Basal		
Select Patterns		
Set/Edit Basal		

Example #1:
Basal patterns

Ken has had his insulin pump for about a month. He tests his blood glucose 4 - 6 times a day and records his results in his logbook. He is happy with his glucose control during the week but on the weekends, he noticed that he has to eat more food to prevent his blood glucose from running too low.

Ken has realized that during the week while he is at work, he is very inactive and sits at a desk most of the time. On the weekends, though, he is busy with yard work, running errands and playing with his kids. He determines that he needs to have lower basal settings to receive less insulin during active times, such as his weekend.

He can use the Basal Patterns feature to support his weekend change in activity. During the week, he can set his pump to deliver in the standard setting, and on Saturday morning, he can switch over to Pattern A, which he can set with lower basal rates for the weekend. On Monday morning, he can return his pump to the Standard setting for his weekday insulin needs.

Example #2:
Basal patterns

Cynthia has had diabetes for about 12 years and has been on her Paradigm pump for several weeks. Every Monday, Wednesday and Friday, Cynthia goes on a 2-mile walk in the morning. To prevent hypoglycemia on these days, she uses the patterns feature. For those days, she simply switches over to Pattern A, which she has programmed with a lower set of basal rates. Before she learned to use the patterns feature, she would have to eat more food throughout the day to keep her blood glucose at a safe level. Cynthia has also noticed that a few days prior to menstruation, her blood glucose levels seem to rise, requiring more insulin. She has programmed Pattern B on her Paradigm pump with higher basal rates for this time. For her usual schedule, she uses the standard basal pattern.

Your turn:

Can you think of situations where you might require different basal rate settings on different days?

Temp basal rates

The temp basal rate feature is useful to manage BG levels during unusual short-term activities or conditions. These conditions could be an illness or unplanned physical activity that is not part of your daily routine.

A temporary basal rate allows an immediate short-term change to your basal insulin for a specified period of time (30 minutes – 24-hours). This rate can be up to your maximum basal rate setting. It offers an easy way to immediately meet short-term insulin needs for temporary activities or situations. When your blood glucose is temporarily high or low, a temp basal rate allows you to set a temporarily higher or lower basal to accommodate your blood glucose.

NOTE - *Temp Basal is useful for a temporary condition or period of increased or decreased activity (i.e. a cold or physical activity) that is not usually part of your lifestyle. For ongoing periods of increased or decreased activity, the patterns feature may be more suitable.*

How does temp basal work?

During a temp basal delivery, all other basal programming is temporarily overridden. After the temp basal delivery is completed, your pump will return to the programmed basal. A temp basal is delivered only once and does not repeat. If you want another temp basal, you must program the temp basal again. This feature may be useful to temporarily increase or decrease basal insulin during illness, exercise or the similar situations.

Temp basal types

Based on your preference, you can select one of two types of temp basals:

- ▶ Percent of basal
- ▶ Insulin rate

Insulin rate

Insulin rate is a fixed basal in units per hour (U/H). This temp basal type is independent of your current basal. When you select **Insulin rate (U/H)** for your temp basal type, your pump will deliver the fixed amount you have set for the duration as set. The amount of your temp basal insulin rate can be set up to your maximum basal rate setting.

If you make changes to your normal basal rate, your U/H temp basal is not affected and will continue to deliver as programmed.

temp basal settings	
temp basal type:	Insulin rate (U/H)
duration:	4:00 hours (1:05p - 5:05p)
rate:	3.50 U/H

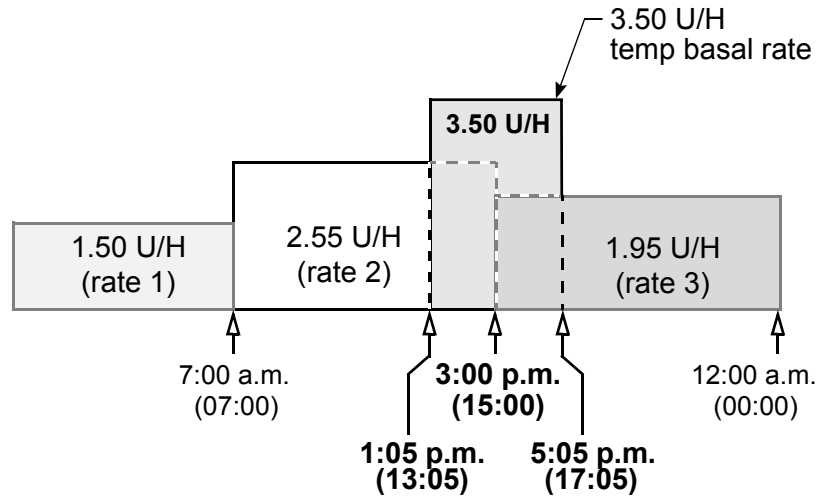

Percent of basal

The temp basal type is dependent on your current basal rates. Percent temp basal is a percentage increase or decrease of your current basal (0 - 200 percent limited to your maximum basal rate setting).

The maximum percent limit is based on the largest basal rate segment of your current basal.

For example: It's 6:00PM (your current basal rate is 1.30 U/H). You want to set a temp basal of 150%.

The maximum percent temp basal you can set is 105%. Anything larger would make #2 segment exceed your max basal setting of 2.0 U/H.

Your current basal rates:

segment #1: 12:00A 1.50 U/H
 segment #2: 11:30A 1.90 U/H (largest)
 segment #3: 4:00P 1.30 U/H

Your max basal rate setting: 2.0 U/H

If your current basal changes (i.e. from rate 1 to rate 2), your percent temp basal amount will also change. The pump will deliver the percentage for the duration that you have set.

You cannot make changes to your normal basal rate while a percent temp basal is active. You must either wait until the temp basal is finished or cancel the temp basal in order to reprogram your normal basal rate setting(s).

NOTE - The pump delivers basal amounts in 0.05 increments. Because of this, your temp basal amount will be rounded down to the next 0.05 increment.

temp basal settings	
temp basal type:	Percent of basal
duration:	4 hours (1:05p - 5:05p)
rate:	120 percent (%)

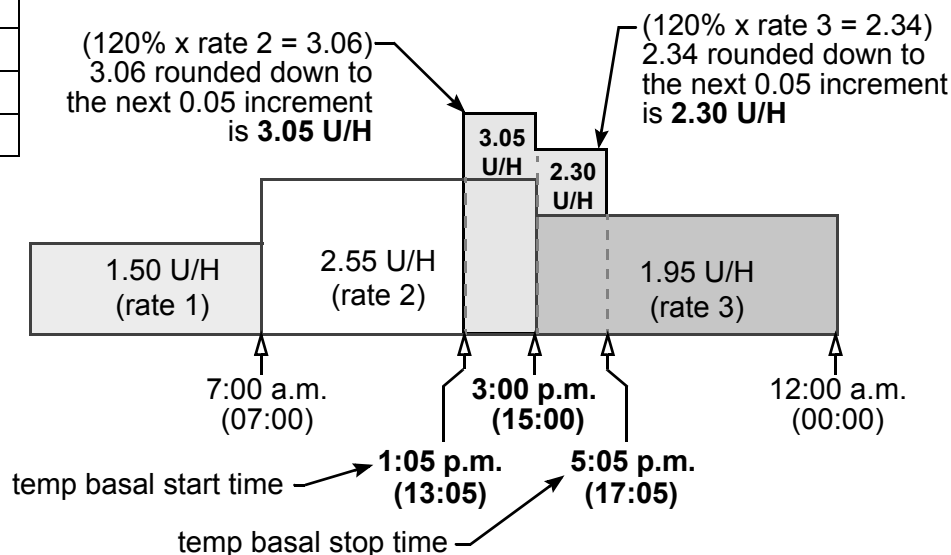

Selecting temp basal type

Your pump will remember the temp basal type setting. Once the type is set, you do not have to set it again. To select a temp basal type, do these steps:

1. Go to the BASAL MENU.

Main > Basal > Temp Basal Type

Select **Temp Basal Type** and press **ACT**.

2. The SET TEMP BASAL AS screen will appear.
Select **Insulin Rate** or **Percent of Basal** and press **ACT**.
3. The screen will return to the BASAL MENU. The temp basal type is now set.
Exit the menus.

NOTE - Be aware. If your temp basal type is set to "Percent of Basal," changes to your basal rate are not allowed until after temp basal is completed or canceled.

Deliver a temp basal

NOTE - A temp basal cannot exceed your programmed max basal rate.

1. Go to the BASAL MENU.

Main > Basal > Set/Edit Temp Basal

Select **Set/Edit Temp Basal** and press **ACT**.

2. The SET DURATION screen will appear. The duration* will flash. Enter the desired minutes or hours (30 minutes - 24-hours), then press **ACT**.

NOTE - * Duration is the amount of time it will take for the pump to deliver the temporary basal.

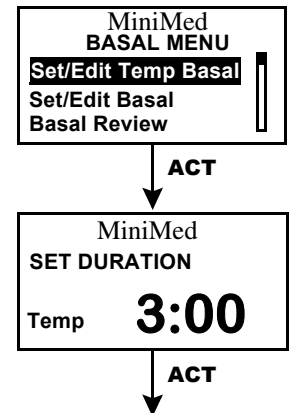
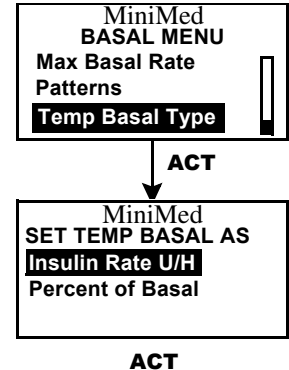

- In the SET TEMP BASAL screen, the temporary basal rate will flash. Enter your temp basal rate, then press **ACT**.

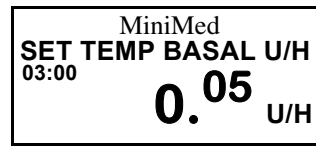

appears if
Temp Basal Type is set
to "Insulin rate (U/H)."

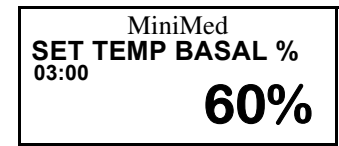

OR
appears if
Temp Basal Type is set
to "Percent of basal."

- The BASAL MENU will appear. Your temp basal is now set and delivering. Exit the menus.



Pump is in Special mode
during a temp basal

Verifying temp basal delivery

Temporary basal information is available in the STATUS screen only.

During a temporary (temp) basal, the pump is in Special mode (open circles appear). These open circles will remind you that a temp basal is active. Additionally, your pump will beep/vibrate three times every hour during delivery. During delivery, the STATUS screen will show the current temp basal information.

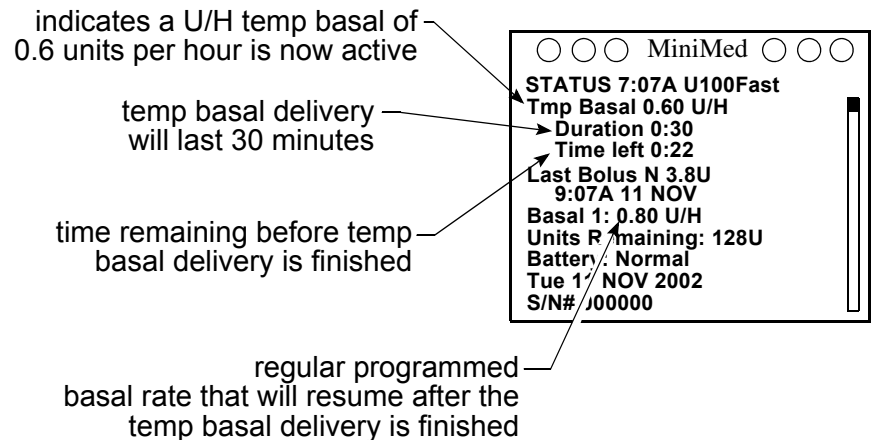

Canceling a temp basal

Use the cancel temp basal function in the BASAL MENU to cancel a temporary basal. This function immediately stops the temp basal and resumes the regular programmed basal delivery. To cancel a temp basal, do these steps:

- Go to the BASAL MENU.
Main > Basal > Cancel Temp Basal
- Select **Cancel Temp Basal** and press **ACT** to accept.

The screen will return to the BASAL MENU. Your temp basal is canceled and the programmed basal is now active again. Exit the menus.

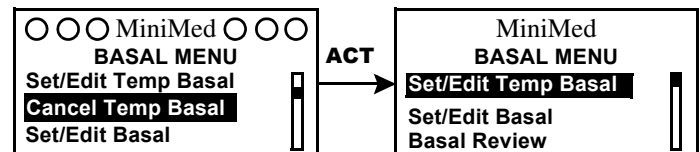

Example #1:**Temp Basal for a decreased temporary basal rate**

Ramon and his friends got together for an unplanned game of soccer. Before using the pump, he was taking shots to manage his diabetes. Ramon experienced frequent low blood glucose reactions sometime during, and very often after, he played games with his friends. Now that he is using his Paradigm pump, he can use the Temporary Basal Rate feature to help prevent low blood glucose. He simply programs his pump to temporarily deliver less basal insulin during the time that he is playing, and often for several hours after play, as well.

Ramon was able to determine how to set his Temporary Basal rates by frequent blood glucose testing, both during and after activity, and recording his results. The first time he tried using the pump, his healthcare professional advised him to program his pump to deliver $\frac{1}{2}$ his usual basal rate for the amount of time that he was playing and for an hour after he was done. He made small adjustments of the temporary basal rate and the duration of time, each time he tried to use the feature. After several different attempts with similar activity for the same amount of time, (such as his soccer game that lasted 2 hours), he found a temporary basal rate that worked well for him.

Example #2:**Temp Basal for an increased temporary basal rate**

Gail has had a cold with a cough for a couple of days. Because she is not feeling well, she tests her blood glucose more frequently. She finds that her blood glucose levels are running above target range before meals and she has needed several correction boluses to keep her blood glucose levels within her normal limits. Gail decides to use the Temporary Basal Rate to increase her basal rate during the day today. As advised by her healthcare professional, she will continue to check her blood glucose more frequently until she is feeling well.

Your turn:

Think of an activity where you might need to use a Temporary Basal Rate.

At what rate is your current basal rate running? _____

What Temporary Basal Rate would you try using at this time? _____

How long will you be active? _____

What duration will you set for the Temporary Basal Rate? _____

Test your blood glucose before and during activity and several times after as well. What are your blood glucose results?

Pre- activity _____

During activity _____

1 hour after activity _____

Several hours after activity _____

What Temporary Basal Rate changes will you make for the next time you try this?

Insulin pump therapy follow-up

We hope that you are now comfortable using the pump and your blood glucose values have improved through insulin pump therapy. Diabetes management requires much more than blood glucose control. You need to take care of your complete physical and mental health. This includes seeking treatment for any condition both directly related to and not related to diabetes. The following recommendations apply to general diabetes as well as insulin pump therapy follow-up. Remember, your healthcare professional is your best resource for successful diabetes management.

Recommended follow-up

Everyday:

- ▀ Check BG 4–6 times a day and always before bed
- ▀ Test before driving and have a fast-acting carbohydrate with you when you drive
- ▀ If your BG is above 250 mg/dl (13.9 mmol/L) twice in a row, take an injection and change the infusion set

Every month:

- ▀ Review DKA prevention guidelines
- ▀ Check 3:00AM BG at least once during the month
- ▀ Check 2-hour post-meal BG for all meals on a given day

Every 3 months:

- ▀ Visit your healthcare professional, even if you feel well and your BG values are within target range
- ▀ Review your BG log and insulin pump settings with your healthcare professional
- ▀ Make sure you have an HbA1c test done

Laboratory tests:

- ▀ Test for HbA1c four or more times a year
- ▀ Test for cholesterol, HDL, LDL, triglyceride yearly
- ▀ Test for microalbuminuria yearly

Every visit:

- ▀ Blood pressure check
- ▀ Foot exam
- ▀ Review goals for BG, meal plan and exercise

Annually:

- ▀ Dilated eye exam by a qualified ophthalmologist
- ▀ Annual flu shot
- ▀ Regular dental visits
- ▀ Nerve function tests
- ▀ EKG test over age 35
- ▀ Prostate exam for men, breast exam for women
- ▀ Diabetes education review
- ▀ Replace Glucagon Emergency Kit

Alarm review

You can review alarms in the ALARM HISTORY screen. This screen shows up to 36 past alarms and/or errors. You can also review the details for each alarm when you are in the ALARM HISTORY screen.

1. Go to the ALARM HISTORY screen

Main > Utilities > Alarm > Alarm History

2. Scroll through your past alarms.
3. If you want to review the details for an alarm, continue to the next section, "Alarm details." Exit the menus if you are done.

Alarm details

4. In the ALARM HISTORY screen, select the alarm you want to review and press **ACT**. The details for that alarm will appear on the screen.
5. Press **ESC** to return to the ALARM HISTORY screen. Select another alarm to review, or exit the menus if you are done.

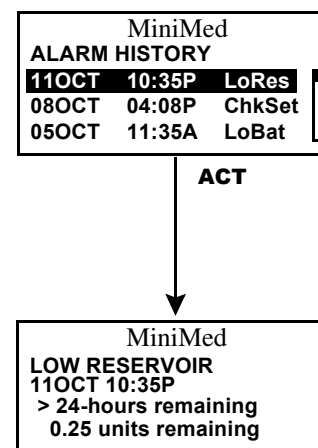

Setting your alert type

You can select the type of alert your pump uses (for alarms, special conditions and programming). You can select a vibrate (silent) alert, or an audible beep alert. There are three beep types: long, medium and short tones. The factory setting for this feature is beep-medium.

The vibrate alert type is disabled if you use the block feature. If your alert type is set to vibrate and you get a LOW BATTERY alert, your pump will use the beep alert type instead to conserve battery power.

NOTE - Vibrate uses more battery power than the beep alert type and may shorten battery life.

1. Go to the ALERT TYPE screen.

Main > Utilities > Alarm > Alert Type

2. Select your alert type and press **ACT**. That alert type is now active. Exit the menus.

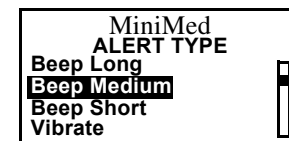

Auto-off

The factory setting for this feature is off (set to 0 hours). This is a safety feature that stops insulin delivery after a defined time period (from 1 to 24-hours). If the pump detects that no buttons have been pressed for the selected amount of time, insulin delivery will stop. You may choose to program this feature into your pump based on the numbers of hours that you usually sleep at night. Discuss what uses and settings are best for you with your healthcare professional.

1. Go to the AUTO OFF DURATION screen.

Main > Utilities > Alarm > Auto Off

2. Set the number of hours you want to set and press **ACT**.

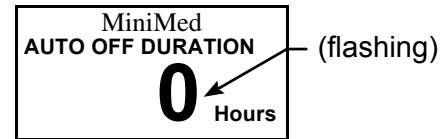

NOTE - If you do not want to use the Auto Off feature, make sure the hour is set to zero (0).

3. The screen will return to the ALARM MENU. The Auto Off feature is now set. Exit the menus.

Low resv alert (Low reservoir warning)

Allows you to program the pump to sound an alert before your reservoir is empty. You can select one of these warning types:

- ➔ a specified number of units that remain in the reservoir
- ➔ a specified maximum amount of time that remains before the reservoir will be empty.

The factory setting for this feature is (20) insulin units.

1. Go to the RESV WARNING TYPE screen.

Main > Utilities > Alarm > Low Resv Warning

2. Select **Insulin units** or **Time** and press **ACT**.



WARNING: When the pump detects a low reservoir condition during a bolus or prime delivery, the alert will go off after the delivery is finished. Make sure to check the volume of your reservoir to ensure enough insulin is available.

For “Insulin units”:

Enter the number of units you want remaining when the first warning will go off. Press **ACT**.

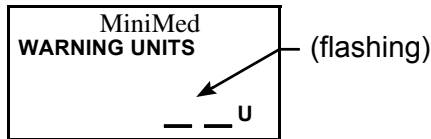

The pump will alarm first when the specified units remain, then again when half that remaining amount is used.

For “Time”:

Enter the amount of remaining time you want for the first warning. Press **ACT**.

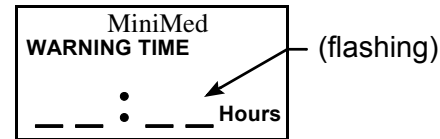

The pump will alarm first when the specified time remains, then again one hour before empty.

NOTE - Be aware. If you use "time" as the low resv warning type and you deliver large boluses, the actual time remaining could be less than the warning time. "Time" low resv warning types are intended to let you know if you will have enough insulin while you are sleeping.

Review daily insulin totals

The DAILY TOTALS screen provides a day-by-day history of the total amount of insulin that delivered for the past 14 days. This screen includes all bolus and basal amounts delivered midnight-to-midnight for each of the past 14 days. The first line in the DAILY TOTALS screen shows the amount of insulin you delivered so far that day.

NOTE - The insulin used to prime your pump are not included in the DAILY TOTALS screen. This amount is counted separately and shown in the PRIME HISTORY screen.

► Why should I review my daily totals?

Comparing your daily insulin deliveries to your blood glucose records helps you and your healthcare professional identify your optimal daily insulin rate(s).

► What is included in the daily totals?

Daily totals include all basal and bolus insulin deliveries, but they do not include insulin used for priming your pump. Each total reflects all basal and bolus insulin delivered for that day.

► Where is the daily totals screen?

Main > Utilities > Daily Totals

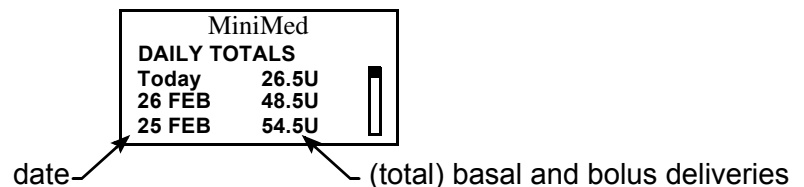

Personal reminders

Alarm clock

The alarm clock is a feature that allows you to set daily reminders for various events (8 max). The factory setting for this feature is off. The alarm clock can be useful to remind you when to check your blood glucose, eat, bolus, etc. When the alarm clock goes off, the message, "REMINDER" will appear.

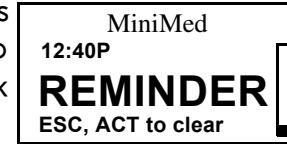

1. Go to the ALARM OPTION screen.

Main > Utilities > Alarm Clock

2. Select **On/Set**.
Press **ACT**.



3. Select **Add Alarm**.
Press **ACT**.

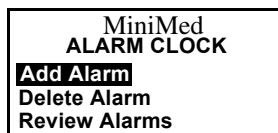

4. Enter the hour (flashing). Press **ACT**.
Enter the minutes (flashing). Press **ACT**.

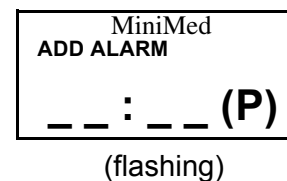

5. Repeat step 4 to program additional alarm times. Exit the menus when you are done.

Remote control option

The factory setting for this feature is off. You may want to explore the remote option after you have become completely familiar with the basic functions of your pump. It is important that you consult with your healthcare professional before using this feature. Remote controls can be purchased from Medtronic MiniMed.

Refer to the remote control user guide for operating instructions.

NOTE - *The use of RF (radio frequency) devices with the pump reduces battery life.*

To use the remote control, these pump settings must be programmed:

- ➔ Remote Options = On
- ➔ Remote control ID code entered in pump (code is on back of remote)
- ➔ Easy Bolus = On

Turn on remote control option

WARNING: If there is “Low Battery” condition, the pump will not receive signals from the remote. To ensure the pump communicates with the remote control, make sure the pump does not have a low battery.
(Replacing the low battery with a new battery will restore remote control function.)

1. Go to the REMOTE OPTION screen. Select **On** and press **ACT**.

Main > Utilities > Remote Options

2. The REMOTE ID MENU screen will appear. Add, delete or review your remote ID as described in the next section. Exit the menus if you are done.

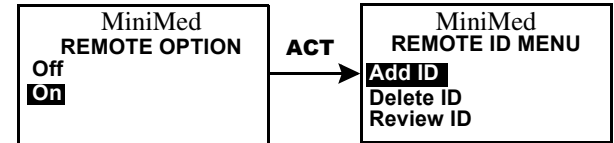

Add, delete, review remote control IDs



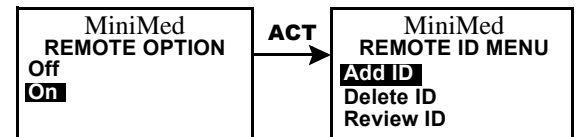

Each remote control has its own unique ID. Up to three (3) different remote control IDs can be programmed in your pump. The remote control programming screens are very similar to those for the meter. Make sure to select “Remote Options” (in the UTILITIES MENU) when programming your remote control.

If you are not sure that your remote control ID is entered in your pump, check the REVIEW REMOTE ID screen. You have to turn on the remote option to add, delete or review the remote control ID(s) programmed in your pump.

1. In the REMOTE OPTION screen, select **On** and press **ACT**. The REMOTE ID MENU will appear.
2. Add, delete or review your remote ID(s) as desired.

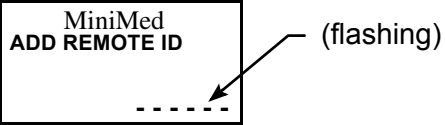

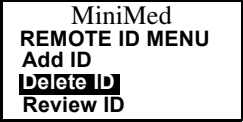
NOTE - The remote control RF ID code is on the back of the remote control.

Add	Delete	Review
<p>Select Add ID and press ACT. Enter each of the six ID numbers. Press ACT after each.</p>  <p>After you set the last number of the ID, the screen will return to the REMOTE ID MENU.</p>	<p>Select Delete ID and press ACT. Select the remote ID that you want to delete and press ACT.</p>  <p>The selected ID is now deleted.</p> 	<p>Select Review ID and press ACT. The programmed IDs will show in the REVIEW REMOTE ID screen.</p> 

3. Exit the menus when your are done.

Block feature

Block restricts access to pump programming. The factory setting for this feature is off. Block is an important safety feature if the pump user requires someone else to maintain complete control of pump operation. When block is on, the remote control is used to deliver a bolus and suspend the pump. Direct pump programming is limited to suspend, block, and selftest. You can, however, still view status-type screens (STATUS, BOLUS and PRIME HISTORY, BASAL REVIEW and DAILY TOTALS). Discuss what uses and settings are best for you with your healthcare professional. (You can order the remote control from Medtronic MiniMed.)

Turn block on

NOTE - *The vibrate alert-type is disabled when block is on.*

1. Go to the BLOCK OPTION screen.
Main > Utilities > Block
2. Select **On** and press **ACT**. The HOME screen will appear with open circles. The Block option is now on and the pump is in Special mode. Exit the menus.

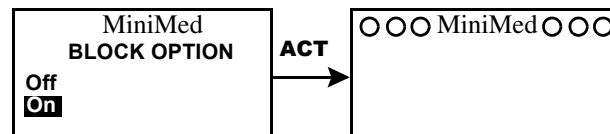

Example #1: Block

Nicholas is a very active toddler who wears a Paradigm pump. His parents don't want to worry that he will play with the pump and accidentally change his programmed settings. They simply activated the Block feature, and now, except for the Suspend and Self-Test, no other features are active when using the pump buttons. When Nicholas needs a bolus, his parents and caregivers simply program it with the Remote Control.

Example #2: Block

Oscar is an elderly man with diabetes who needs assistance with all of his daily living activities. He needs his caregiver or family member to help him with his pump as well. To be sure that Oscar does not change any pump settings, his family programmed his Paradigm pump with the Block feature turned on. They use the Remote Control to give him his boluses when he needs them.

Selftest

Selftest is a safety utility that allows you to check if your pump is operating properly. This self-diagnostic feature can be used for maintenance or to check your pump if it operates unusually. During selftest, your pump will automatically run internal tests, including a check for proper operation of the beep and vibrate modes. The selftest is additional to the routine tests that run independently while the pump operates.

Contact the Medtronic MiniMed 24-hour Product Help Line if any of the tests do not occur as described here.

NOTE - If the pump detects a condition such as low battery, the selftest will not finish. A message will appear to show the condition that caused the test to stop.

1. Go to the UTILITIES MENU. Select **Selftest** and press **ACT**.

Main > Utilities > Selftest

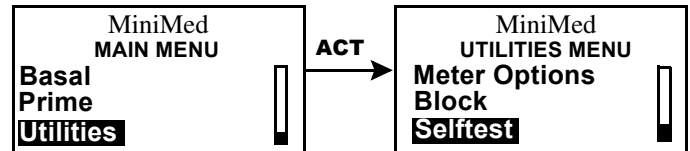

2. As part of the selftests, the pump will do these tests:

NOTE - Periodically, you will hear beeps as different mechanisms in the pump are being tested.

- a. Screen Test:
The screen will appear all black as shown here.



- b. Selftest:
The pump will count down from 10.



- c. Tone Test:
You should hear beeps.

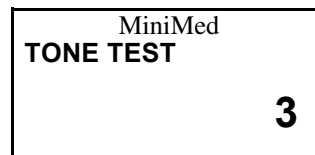

- d. Vibrate Test:
You will feel vibrations.



3. After the selftest is finished, TEST COMPLETE will appear on the screen. The screen will return to the UTILITIES MENU, then to the HOME screen.

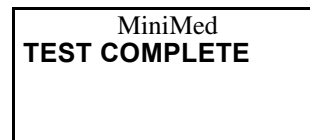

Clear pump

The clear pump function resets the time and date and clears all pump settings except for language. The pump settings are restored to the factory defaults. When you clear your pump, you must reprogram all your settings before you can use your pump again. The pump does not clear the internal pump memory.

WARNING: Do not clear your pump while it is connected to your body.

CAUTION: Do not clear your pump unless directed by your healthcare professional or a Medtronic MiniMed representative. If you clear your pump, it will be necessary to reprogram all your personal pump settings as directed by your healthcare professional. Additionally, you will have to rewind your pump.

Do these steps to clear your pump:

1. Go to the CLEAR PUMP screen. Select **Settings** and press **ACT**.
Main > Utilities > Clear Pump

2. The CONFIRM screen will ask you to verify that you want to clear the pump. Select **Yes** then press **ACT**.

3. The RESET message will appear indicating the pump settings have been cleared. Read the instructions on the screen then press **ESC, ACT** to clear the message.

4. The pump will go through various screens while it restarts. After the pump clears all your settings, the screen will go to the TIME/DATE SETUP screen.

5. Reset the time and date as described in the section, "Setting the time and date" in chapter 3.

6. After you set the time and date, you must rewind your pump. Refer to the section, "Rewinding your pump" in chapter 4 for instructions. Remember, all your setting have been cleared and you must reprogram all your settings.

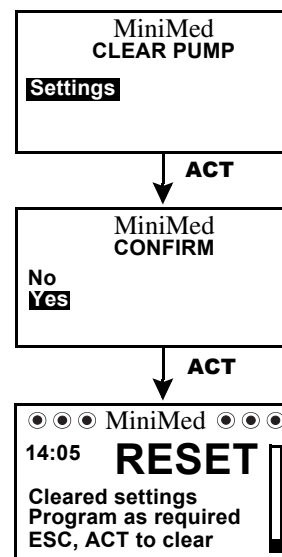

Select your insulin type

WARNING: Do not change your insulin type unless your healthcare professional has instructed you to do so.

Make sure you select the correct insulin type. The correct insulin type is essential for proper use of the Bolus Wizard.

The factory setting for the insulin type is 100U fast-acting. If you are preparing your pump for the first time, or you have changed insulin type and need to change the pump setting, do these steps:

NOTE - When you change the insulin type in your pump, you will also have to rewind your pump.

1. Go to the INSULIN TYPE screen and select your type. Press **ACT**.

Main > Prime > Insulin Change

2. The pump will siren (or vibrate) and the INSULIN CHANGE screen will appear to warn that you are changing your insulin type. Press **ACT** to continue.

TIP - If you realize you do not want to change insulin type, press **ESC** now. The **PRIME** Menu will appear. Exit the menus. No changes will be made.

3. Read the message on the screen and press **ACT** again to continue. To cancel, press **ESC**.
4. The **VERIFY INSULIN CHANGE** screen will appear. Select **Yes** if the insulin type is correct. Press **ACT** and continue to step 5.

If the insulin type is not correct:

- a. Select **No** and press **ACT**. The **INSULIN TYPE** screen will appear again (see step 1).
- b. Repeat steps 1 through 4.

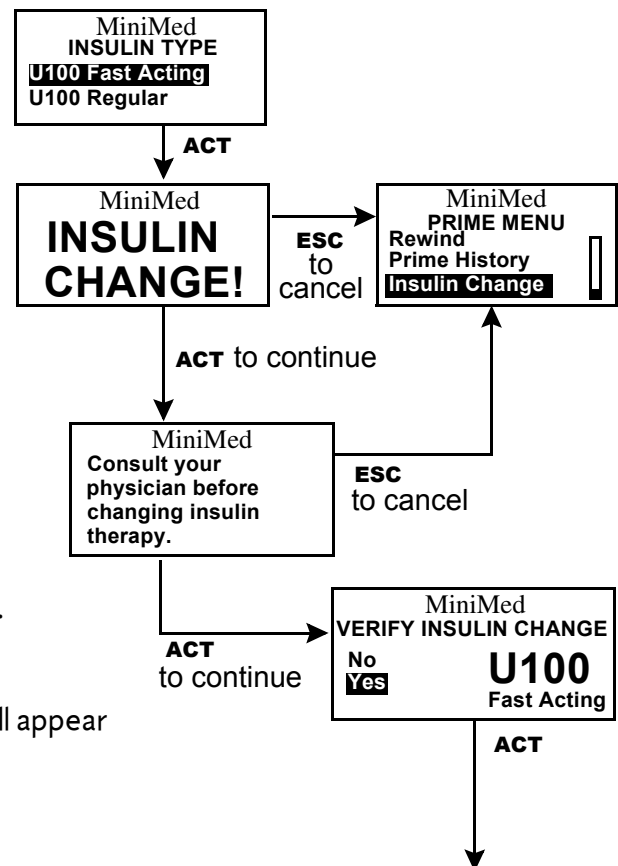

5. The REWIND screen will appear for 30 seconds, then default to the HOME screen. You must now rewind your pump as described in the section, "Rewinding your pump" in chapter 4.



Language setting

The language shown on the pump screens can be changed. Some languages will not be available on all pumps. To change the language for your pump, do these steps:

1. Go to the LANGUAGE MENU. Select your language and press **ACT**.

Main > Utilities > Language

2. The language setting is now changed. Exit the menus.

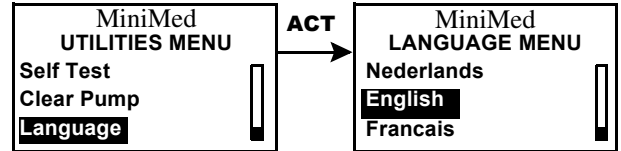

NOTE - It is recommended that you read your warranty statement included with your pump for information on what is covered during your warranty period.

Troubleshooting

My pump has a no delivery alarm...

When a “No Delivery” alarm occurs, it means the pump is working correctly. Your pump is not broken, but it has detected that something is preventing insulin from being delivered. Do the following steps:

1. Check your blood glucose and take an injection if needed.
2. Make sure that there is insulin in your reservoir and the tubing is not kinked. If these are all right, go to step 5.
3. If necessary unkink tubing. Clear the alarm by pressing **ESC** and **ACT**. A screen will appear with two choices; **Resume** and **Rewind**. Select **Resume**.
4. If the reservoir is empty, clear the alarm by pressing **ESC** and **ACT**. Select **Rewind** and change your reservoir and infusion set per the instructions in chapter 4, “Starting on insulin.”
5. Continue troubleshooting by disconnecting at the quick-disconnect and set a 10 unit Fixed Prime.
6. Does insulin come out of the needle at the quick-disconnect?
 - a. If yes, change your entire infusion set per the instructions in chapter 4, “Starting on insulin.”
If NO insulin comes out of the needle at the quick-disconnect or you receive another No Delivery alarm call the 24-hour Product Help Line.
 - b. Your pump remembers the last fixed prime you deliver, so make sure to set your fixed prime amount back to your usual setting. To do this, deliver another fixed prime in your normal amount (the amount specified in your infusion set instructions).
7. Monitor your blood glucose closely.
8. If you followed these steps and you are still receiving a No Delivery alarm, call the 24-hour Product Help Line.

What happens if I leave the battery out too long?

If you leave the battery out too long (more than five minutes) you may receive a BATT OUT LIMIT alarm message when you install the new battery. Do the following steps:

1. Set your pump clock to the correct time, date, and year.
2. Check to make sure that all your settings, such as basal rate, are set as desired.
3. Check the ALARM HISTORY screen and the STATUS screen for any alarms and/or alerts that may still need attention.

Why doesn't my pump battery last very long?

Battery life in your pump is variable and based on the conditions below. As a result, your battery life will vary. A short battery life does not necessarily mean something is wrong with your pump.

- ➔ The brand of battery you use (we recommend Energizer)
- ➔ The way the battery was stored and/or handled before use (avoid high or low temperatures)
- ➔ How you use your pump. For example: how often the buttons are pushed, the number of alerts/alarms and set changes.
- ➔ How much insulin you are delivering.
- ➔ Use of some features. The backlight, vibrate, remote control and/or meter options decrease battery life.

What is a CHECK SETTINGS alarm?

This alarm will occur after an E alarm or after you clear your pump. Make sure that all your settings are correct. A CHECK SETTINGS alarm occurs after any of these actions:

- ➔ all user settings were cleared (set back to their defaults) because there was an E-error alarm,
- ➔ the "Clear Pump" function was performed,
- ➔ or after the user exits the training mode (user settings are retained). In this case, it is just a reminder to make sure all your settings are programmed before you begin using the pump with insulin.

My screen appears distorted...

The screen may appear distorted or have a "rainbow" appearance if you are wearing polarized sunglasses, are in bright sunlight, or in extreme high or low temperatures. If your screen appears distorted:

- ➔ take off your sunglasses
- ➔ move into the shade
- ➔ make sure your pump is not in direct heat (i.e., next to a heater) or cold (worn on the outside of your clothing on a very cold day).

Do not return the pump: this is a normal property of this type of screen on any device.

I can't get out of the priming loop...

1. Is there a filled reservoir in the pump?
 - If no, place a filled reservoir or shipping cap in the pump.
 - If yes, make sure you are disconnected from the pump.
2. Hold the **ACT** button until the second set of beeps and numbers appear on the screen.
 - If yes, your pump is okay, go to step 4 in the section, "Manual prime" (chapter 4) to finish the manual prime.
 - If you did not hear second set of beeps or numbers did not appear on the screen, change your infusion set and repeat this step.
3. If you still do not hear the beeps and see the numbers count up on the screen, call the 24-hour Product Help Line.

The pump is asking me to rewind...

This is normal after any of the following:

1. any E-alarms,
2. Clear Pump function,
3. You change your insulin type setting.
4. After a "No Delivery" Alarm (during the Prime sequence)

My bolus stopped...

The Bolus Stopped error can occur if the battery cap is loose or the pump was bumped or dropped during a bolus. It can also happen if the pump receives a static shock. As a safety measure, the pump stops the bolus when this happens.

1. If you dropped your pump, visually inspect it to make sure that it is not damaged in any way.
2. Review your bolus history and reprogram the remaining bolus, if needed.

My pump buttons are not acting right during a bolus...

If any button is pressed and held down while a bolus is being delivered, the screen will freeze on that amount. Once the button is released, the units will ramp up to the amount delivered so far. Pressing and holding down the button will not stop the delivery of a bolus.

My pump won't display my BG reading from my meter...

1. Make sure you are using the correct meter (Paradigm Link Blood Glucose Monitor Powered by BD Logic Technology). Your 512 pump will communicate with this meter only.
2. Make sure your meter is on (set to "snd") and working correctly.
3. Make sure the meter option in your pump is set to "on" and your meter ID is programmed correctly.
4. Make sure your pump does not have a low battery alert condition.
5. Make sure the meter is within 4 feet (1.2 meters) of the pump without anything in between such as another person, a wall, etc.
6. Make sure there is no RF (radio frequency) interference from other electronic devices that could prevent communication. These devices can include some cell phones, cordless phones, televisions, computers, radios, other Paradigm pumps meters and pump remote controls. To restore communication, simply move away from these other types of devices, or turn them off.
7. Your pump will not show another reading. Make sure the pump is idle and the HOME screen is blank
8. If your pump still does not receive your BG reading from the Paradigm Link meter, use the up/down buttons to manually enter your BG (in the ENTER BG screen).

I dropped my pump

Take care to protect your pump from being dropped.

1. Check that all connections are still tightly in place.
2. Check the LCD, keypad and pump case for cracks or damage.
3. Check infusion set, including the tubing connector and tubing for cracks or damage.
4. Review the status screen, basal rates and other pump settings.
5. Perform the Selftest procedure located in the UTILITIES MENU.
6. Call the Medtronic MiniMed 24-hour Product Help Line for assistance.

I submerged my pump in water

Your pump is water tight but should not be deliberately submerged in water during bathing, swimming, or other water activities.

1. Pat the outside of the case until dry.
2. Open the reservoir compartment and check the compartment and reservoir for water. If wet, dry it completely within ten (10) minutes of exposure to water. Exposure to liquids, including water or insulin can corrode the mechanism.
3. Dry the reservoir completely - do NOT place a wet reservoir in the pump.
4. Do not use hot air to dry your pump. This may damage your pump's internal electronics.
5. Check the battery compartment and the battery - if wet, let them dry completely before using the pump.
6. Perform a selftest.

Alarms

Your pump has a sophisticated network of safety checks and systems. If the safety network detects anything unusual, your pump notifies you of conditions that require your immediate attention. The backlight will illuminate the pump screen and the alarm/alert message will appear on the screen.

NOTE - *The STATUS screen will show any alarms and alerts that are active.*

► Why are alarms important?

Your pump monitors activities and will notify you if there is an unusual pump status or your attention is required. When an attention alarm is active, INSULIN DELIVERY IS STOPPED and immediate operator interaction is required.

An alarm will gradually become higher in pitch until you turn it off. If the vibrate mode is on, all alarms and alerts will start as vibrations then change to beeps. For your safety, if there is no response after ten (10) minutes, the beeps will change to a siren. The siren will continue every minute until the alarm is cleared.

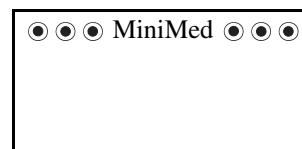

when solid circles appear,
follow the instructions
on the screen.

What to do

When an alarm is triggered, the pump goes into Attention mode and an alarm message will show on the screen. The pump will then default to the HOME screen. Do these steps when you get an alarm:

1. View the alarm:

From the HOME screen, press any button to see the alarm message.

2. Read all of the alarm text. There will be instructions on how to fix the alarm condition. (Press  to read more text, if available.)

3. Clear the alarm:

Press **ESC** then **ACT** after you read the alarm instructions.

4. The HOME screen will appear.

5. Follow the instructions that appeared with the alarm to fix the alarm condition.

6. Check your settings (i.e., time/date, basal, etc.) to make sure they are correct.

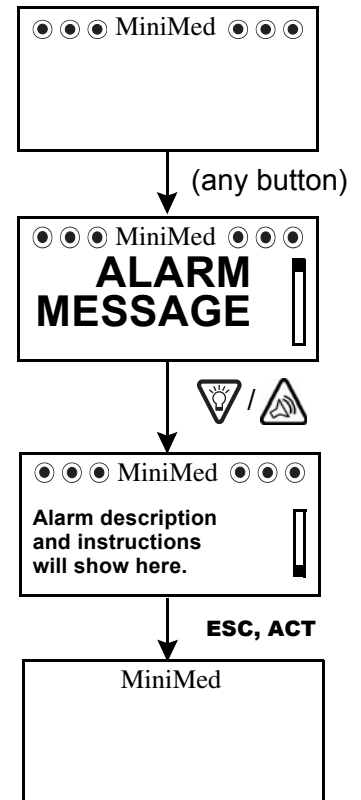

Alarm conditions

Alarms put the pump in "Attention" mode.

A (Alarm)

This alarm will show an "A" followed by two numbers.

A-alarms cause all insulin delivery to stop. Your pump settings are retained. If this alarm repeats often, call the Medtronic MiniMed 24-hour Product Help Line for assistance.

Auto off

Alerts you that no buttons have been pressed during the time limit you set for the AUTO OFF DURATION feature.

Batt out limit

Occurs if the battery has been out of the pump for more than five minutes. The clock will reset to 12:00A, 01Jan03.

Bolus stopped

If this alarm should occur, it is very important to check bolus history to review how much of the bolus was actually delivered. Reprogram a bolus with the amount not delivered, if required.

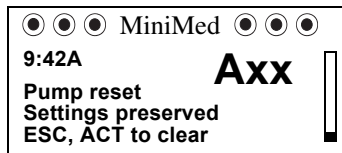

XX indicates the alarm number

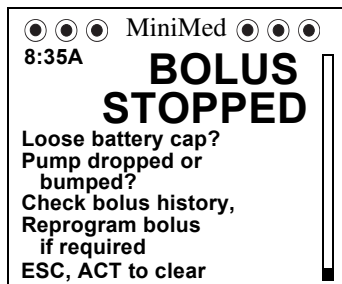
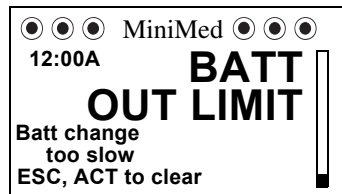
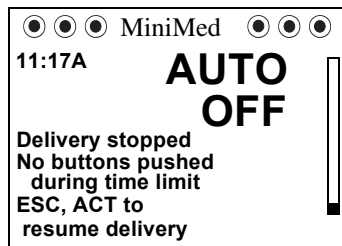

Button error

Occurs if a button has been continually pressed for more than 3 minutes.

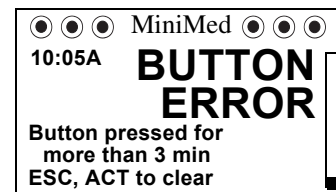

Check settings

When this alarm is active, you should check and/or reprogram your pump settings, including the time/date.

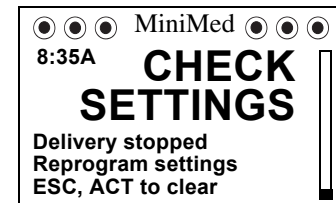

E (Error)

After receiving this alarm, note the error number then call the Medtronic MiniMed 24-hour Product Help Line for assistance. An error alarm will show an "E" followed by two numbers. E-alarms cause all insulin delivery to stop, the pump resets, and all your settings are cleared.

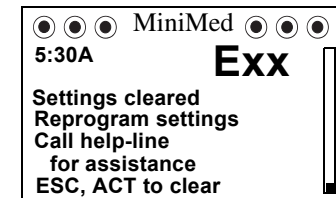

XX indicates the error number

Empty reservoir

There is no insulin in the reservoir. Change the reservoir immediately.

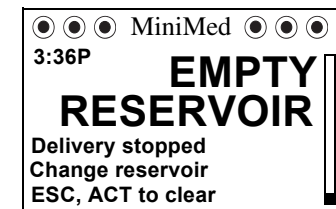

Failed batt test

The pump tests the voltage of each battery installed. This test ensures a battery with low voltage is not used. If the battery does not have enough voltage, this alarm will occur. The pump will not function and the battery must be replaced. (Always make sure that you install a NEW battery into the pump.)



Is priming complete?

If you manually prime your pump with more than 30u insulin, this message will appear. Press **ESC, ACT** to clear the message. If manual prime is complete, press **ESC**. If the manual prime is not complete, press and hold **ACT** until manual prime is complete.

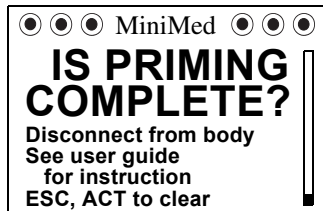

Max delivery

This alarm alerts you when you have taken more insulin than expected based on maximum bolus and maximum basal rates.



Motor error

Insulin delivery has stopped. This alarm will occur if your pump detects a motor error.

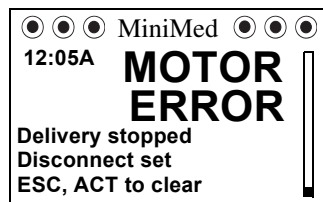

No delivery

Insulin delivery has stopped. This alarm will occur if your pump detects a blockage.

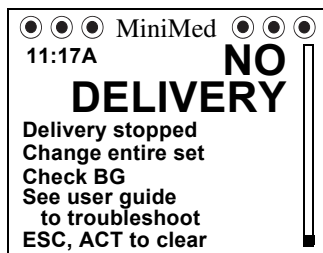

No reservoir

The reservoir is not inserted correctly or no reservoir has been inserted.



Off no power

The battery is dead. Replace battery immediately. Follow the directions on the screen. Check to make sure that the time is correct on the screen. Reset the time if necessary.



Reset

Reset alarm triggers when pump settings are cleared because:

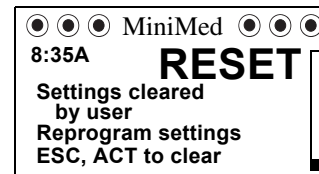

- pump was cleared (clear pump function) and settings have not been reprogrammed, or
- download attempt from PC is incomplete. (Download function is applicable to the optional software feature. Refer to the software user guide for more information.)

Weak Battery

(712 pump only)
The pump tests the voltage of each battery installed. If the battery voltage is less than full strength, this alarm may occur. The pump will function, but the battery life will be shorter than expected.

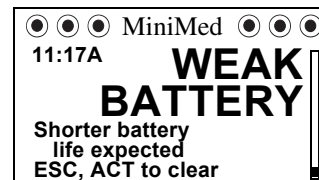

Always make sure to install a NEW battery in the pump.

It is recommended that you read your warranty statement included with your pump for information about what is covered during your warranty period.

Battery

The Paradigm pump uses a AAA alkaline battery. As a safety measure, Medtronic MiniMed has designed the pump to only accept a NEW battery. The pump is very particular, if you insert a used battery, an alarm will be triggered. Refer to the section, "Install battery" in chapter 2 for instructions.

The use of cold batteries causes erratic pump behavior. To prevent this, do not use batteries that have been in cold storage (i.e., in the refrigerator or your car in the winter). It takes several hours for these batteries to warm to room temperature.

Certain features on the pump use a lot of battery power. Your battery will need to be replaced more frequently if you use these features:

- ➡ Remote control
- ➡ Paradigm Link meter
- ➡ Backlight
- ➡ Vibrate alert type setting

CAUTION: It is highly recommended that you use an AAA alkaline Energizer battery. Do not use a carbon zinc battery in the pump. Do not remove the battery unless you are changing your battery (installing a NEW battery). Replace it within five (5) minutes. If not replaced within five (5) minutes, the screen may display an alarm message. Follow the instructions in the message and make sure the time and date is set correctly. Install a new battery if the battery was placed backwards in the pump.

Storage

If you have to remove and store your pump, it is recommended that you store it with the battery in place. Keep a record of your current basal rates. To preserve battery life, reset the basal rates to 0 (zero), turn off the remote and meter options, and set the Auto-off to dashes or zeroes.

Cleaning your pump

1. Use only a damp cloth and mild detergent mixed with water to clean the outside of your pump.
2. After wiping down the pump, rinse with clean water and dry with a cloth.
3. Never use organic solvents, such as lighter fluid, nail polish remover, or paint thinner to clean your pump.
4. Keep the reservoir compartment and battery compartment dry and away from moisture.
5. Do not use any lubricants with your pump.
6. Use a 70 percent alcohol wipe to disinfect your pump.

Precautions

Avoid extreme temperatures

1. Avoid exposure of your pump and remote control to temperatures above 108°F (42°C) or below 34°F (1°C).
2. Insulin solutions freeze near 32°F (0°C) and degrade at high temperatures. If you are outside in cold weather, wear your pump close to your body and cover it with warm clothing. If you are in a warm environment, take measures to keep your pump and insulin cool.
3. Do not steam, sterilize or autoclave your pump or remote control.

Avoid dunking the pump in water

Your pump is watertight but should not be deliberately submerged in water during bathing, swimming, or other water activities. We recommend using an infusion set with a quick release feature to disconnect from the pump before water activities.

If you inadvertently submerge your pump in water, refer to the Troubleshooting section in this user guide.

Indications

The pump is indicated for the continuous delivery of insulin, at set and variable rates, for the management of diabetes mellitus in persons requiring insulin.

Contraindications

Pump therapy is not recommended for people who are unwilling or unable to perform a minimum of four (4) blood glucose tests per day and to maintain contact with their healthcare professional. Successful insulin pump therapy requires sufficient vision or hearing to allow recognition of the pump signals and alarms.

Warnings

Reservoir and infusion sets

Standard Luer infusion sets are not compatible with the Medtronic MiniMed Paradigm pump. Medtronic Minimed Paradigm reservoir and Paradigm infusion sets are specifically designed for use with the pump. Do not modify your Paradigm reservoir or Paradigm infusion set.

Do not put any other drugs/medications inside your reservoir to use with this pump. Only insulin that has been prescribed by your physician can be used in this pump.

X-rays, MRIs and CT scans

If you are going to have an X-ray, CT scan, MRI or other type of exposure to radiation, TAKE OFF YOUR PUMP, METER AND REMOTE CONTROL and remove them from the area.

NOTE - *The pump is designed to withstand common electrostatic and electromagnetic interference, including airport security systems.*

Precautions

Although the pump has multiple safety alarms, it cannot notify you if the set is leaking or the insulin has lost its potency. **It is essential, therefore, that you test your blood glucose levels at least four times per day.** If your BG is out of range, check the pump and the infusion set to ensure that the necessary amount of insulin is being delivered.

Precautions - infusion sets and sites

Avoid using an infusion site that will be irritated by clothing and accessories, or by rigorous stretching and exercise.

Notice

CAUTION: Any changes or modifications to the devices not expressly approved by Medtronic MiniMed could void your ability to operate the equipment.

Insulin pump and RF accessories

The pump, Paradigm Link meter and remote control comply with the United States Federal Communications Commission and international standards for Electromagnetic Compatibility.

Do not use the RF meter to send your BG reading to the pump while on board aircraft. Manually enter your BG.

These devices comply with Part 15 of the FCC Rules. Operation is subject to the following two conditions: (1) This device may not cause harmful interference, and (2) this device must accept any interference received, including interference that may cause undesirable operation. It does not interfere with any RF signals transmitted from outside sources.

These standards are designed to provide reasonable protection against excessive radio frequency interference and prevent undesirable operation of the device from unwanted electromagnetic interference. Operation is subject to the following two conditions:

1. This device has been tested and found to comply with the regulations governing such devices in your area. For the specific regulation and test results for your area, please contact the Medtronic MiniMed 24-hour Product Help Line.
2. This device generates, uses, and can radiate radio frequency energy and, if installed and used in accordance with the instruction, may cause harmful interference to radio communications. If the device does cause interference to radio or television reception, you are encouraged to try to correct the interference by one or more of the following measures:
 - Reorient or relocate the insulin pump/remote control
 - Increase the separation between the insulin pump/remote control and the device that is receiving/emitting interference

The Paradigm Link meter transmits information to the pump using radio frequency. If other devices that use radio frequency are in use, such as cell phones, cordless phones and wireless networks, they may prevent communication between the pump and the meter. This interference will not cause any incorrect data to be sent and will not cause any harm to your pump or meter. Moving away from or turning off these other devices may allow communication. Refer to chapter 9, "Troubleshooting and alarms" to correct interference problems you may have.

If you have questions, please contact the Medtronic MiniMed 24-hour Product Help Line.

This section provides detailed information on specifications related to your pump. The safety features of your pump are individually listed and described.

Alarms and error messages

Indicators: audible tone (beep) or vibration (silent)

All alarms and errors show messages on the pump's screen and provide instructions on what to do. Unresolved alarms will escalate to siren mode for added safety.

Alarm history

Maximum records shown: 36

Backlight

LCD (Liquid Crystal Display) type

Time-out: 7 seconds (in the HOME screen);
30 seconds (after the last button press).

Basal

Delivery: 0.05 – 35 units/hour (Maximum units: 35/hour)

Factory maximum setting: 2.0 units/hour

Increments: 0.05 units

3 patterns maximum, each with 48 rates maximum

BG target

Maximum targets: 8

range: 80 – 160 mg/dL
(4.4 – 8.9 mmol/L)

warning limits: less than 90 or greater than 140 mg/dL
(less than 5.0 or greater than 7.8 mmol/L)

Bolus delivery

Insulin delivered/ stroke	Fluid delivered/ stroke	Time between delivery strokes	Delivery rate (per minute)
0.05u	0.5 μ L	2 seconds	1.5u

Bolus history

Maximum records shown: 24

Bolus units

Increments: 0.1 units

Bolus Wizard

(see end of this section for information)

Carb ratios

Maximum ratio settings: 8 range: 3 – 75 grams/u warning limits: less than 5 or greater than 50 grams/u
0.2 – 5.0 u/exch less than 0.3 or greater than 3.0 u/exch

Carb units

(The food entry when using Bolus Wizard)

grams: 0 – 300 (increments: 1 gram)
exchanges: 0.0 – 20 (increments: 0.5 exch)

Daily totals

Maximum records shown: 14 days of data, maximum display: 999.95 units/day
Accuracy: +0/–0.05 units

Default screen

The HOME screen. If no buttons are pressed for 30 seconds
(60 seconds for status type screens), the pump returns to this screen.

Delivery accuracy

Delivery accuracy: $\pm 5\%$. Displacement (piston) accuracy: $\pm 2\%$

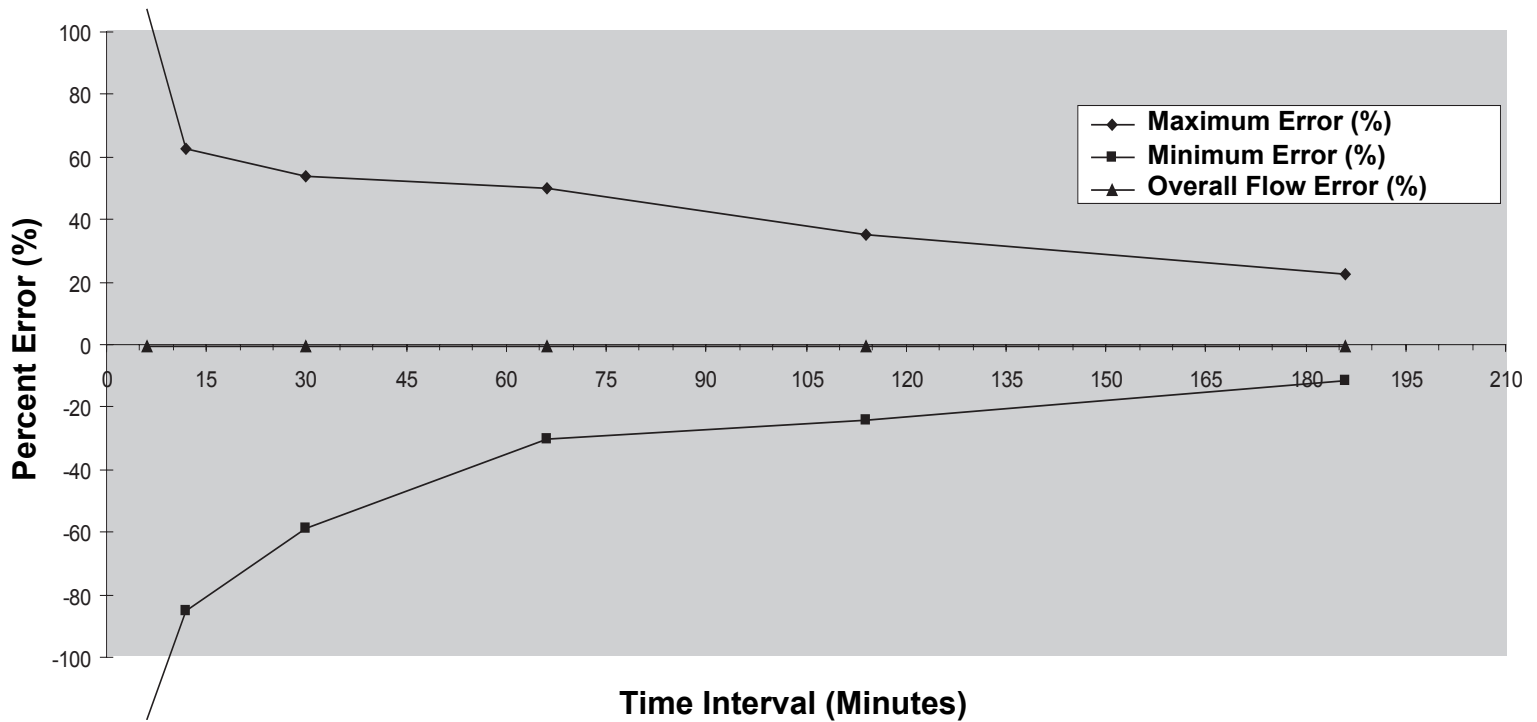

Drive motor

The pump motor has a unique, patented design with an integrated safety check system. The system delivers in precise increments.

Dual Wave bolus

Delivers a Normal bolus followed by a Square Wave bolus (limited by maximum bolus).

Easy bolus

Features programming using audible tones (or vibrate pulses) in user-determined increments. Beep mode range: 0 to maximum bolus; Vibrate mode range: 0 to 20 steps or maximum bolus, whichever comes first.

Default step increment: 0.1 unit

Step size < maximum bolus.

Adjustable step size: 0.1 to 2.0 units per step.

Accessible from the remote control or pump buttons.

Infusion pressure

Maximum infusion pressure and occlusion pressure: 13.7 PSI.

(insulin) sensitivity

Maximum settings: 8

Factory default: 50 mg/dL (2.8 mmol/L)

range: 10 – 250 mg/dL

(0.5 – 13.9 mmol/L)

warning limits: less than 20 or greater than 100 mg/dL

(less than 1.1 or greater than 5.6 mmol/L)

Insulin type

Pump users can select one: U100 fast-acting (default) U100 regular-acting

Low resv (reservoir) warning

Values are based on displayed amount, not actual amount.

time:	2 – 24-hours, and @ 1:00 hour before empty	08:00 hours (default when time is selected)
units:	5 – 50 units, and @ 1/2 amount remaining	20 units (factory default)

Meter value

The BG measurement received from Paradigm Link meter. Appears in the ENTER BG screen during bolus programming. Appears on the screen when the pump is idle at the HOME screen.

Expiration: 12 minutes;

Range: 20 – 600 mg/dL

maximum meter entries: 3

Normal bolus

Range 0.1 – 25.0 units of insulin (limited by maximum bolus setting).

Occlusion detection

When occlusion is detected, the “no delivery alarm” will occur. The occlusion alarm is triggered by an average of 2.35 units of “missed” insulin. This table shows occlusion detection for 3 different situations when using U100 insulin.

Rate	Minimum time before alarm	Typical time before alarm	Maximum time before alarm
bolus delivery (1.5 u/minute)	26 seconds	94 seconds	2.5 minutes
basal delivery (1.0 u/h)	40 minutes	141 minutes	4 hours
basal delivery (0.05 u/h)	13 hours	47 hours	81 hours

Percent temp basal

Default value: 100% of basal programming

Power supply

The pump is powered by a standard 1.5 V AAA alkaline battery (Energizer brand recommended for best results).

Prime function

Fixed prime: 0.1 – 25.0 units (limited by maximum bolus)

Manual prime limit: warning at 30 units, then at each 10 units thereafter.

Fill rate: 1 to 5 units/second.

Prime insulin is not counted in daily totals but is recorded separately in the prime history.

Prime history

Maximum records shown: 20 (manual and fixed)

Program safety checks

Over 50 independent safety systems are continuously monitoring all pump operations.

Maximum infusion with single fault condition: 0.0074 ml.

Pump size

The dimensions of the pump are:

512 Pump:	2.0 x 3.0 (2.8 at the battery cap) x 0.77 inches [5.0 x 7.6 (7.1 at the battery cap) x 2 cm]
712 Pump:	2.1 x 3.7 (3.5 at the battery cap) x 0.8 inches [5.3 x 9.4 (8.9 at the battery cap) x 2.0 cm].

Pump weight

512 and 712 pump: approximately 103 grams (with battery installed)

Remote control

Uses radio signals to allow users to program Normal boluses or to suspend/resume their pumps.

Reservoir

The user-filled reservoir is made from impact-resistant, insulin-compatible polypropylene.

512 Pump volume: up to 176 units of U100 insulin

712 Pump volume: up to 300 units of U100 insulin.

Square Wave bolus

Delivers bolus insulin over a duration of 30 minutes up to 8 hours (limited by the max bolus setting).

Status screen

➡ Time and insulin type	(always appears)	
➡ Status of pump	(i.e., Rewind, Suspended, Low Reservoir, Set Time, etc.)	
➡ Block:	(if active)	ON
➡ BG meter value: (most recent BG value received)	(appears if BG meter is enabled)	XXXmg/dL time and date (received)
➡ Last bolus information:	type and units delivered delivery time and date	('S'-Square, 'N'-Normal, 'D'-Dual)
➡ Basal pattern information	(if active)	Pattern A or B
➡ Current temp basal information: (if currently active)	(if active)	rate (units per hour) duration time remaining
➡ Standard basal delivery data:	(always appears)	current basal rate (basal 1, basal 2, etc.)
➡ Reservoir started:	(always appears)	date, time units left time left
➡ BG Reminder in:	Time remaining before BG reminder is set to go off H:MM h (if less than 1 hour, 0:XXh where XX is minutes remaining)	
➡ Remote On:	(appears if enabled)	
➡ Meter On:	(appears if enabled)	
➡ Meter Off, Low Batt:	(appears if enabled but battery is low or empty)	
➡ Battery Status:	(always appears)	Normal, Low, Off, Weak* (*712 pump only)
➡ Auto-off	(appears if enabled)	X HR
➡ Current date:	DDD ## MMM YYYY	
➡ Serial number:	(always appears)	
➡ Pump model number:	(always appears)	
➡ Software version:	(always appears)	

Temporary (temp) basal rate

Allows you to temporarily change the current basal rate for a duration of 30 minutes up to 24-hours (limited by maximum basal setting). The temp basal rate can be set to either Percent of basal or Insulin rate.

Time and date screen

Pump users have the choice of 12-hour or 24-hour formats. Pump users set the time/date, including the year, month and day. The date/time always appears in the status screen.

Water tight

Conforms to IEC60601-1 sub-clause 44.6 and IEC60529 IPX7 standard.

Bolus Wizard specifications

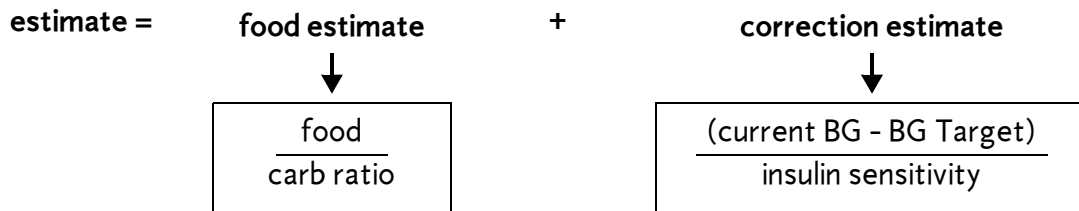

notes:

- Active insulin is based on timing of previous bolus insulin and insulin type. Four to six hours after a bolus, the majority of insulin has been absorbed, but a very small amount is active for a few more hours. The Bolus Wizard automatically calculates this and subtracts the appropriate amount. The details will appear in the ESTIMATE DETAILS screen during the bolus programming steps.

ESTIMATE DETAILS	
Est total:	4.0U
Food intake:	45gr
(Meter) BG:	160
Food:	3.0U
Correction:	2.0U
Active Ins:	1.0U
ACT to proceed, ESC to back up	

(values shown are for example only)

- Insulin Activity Data

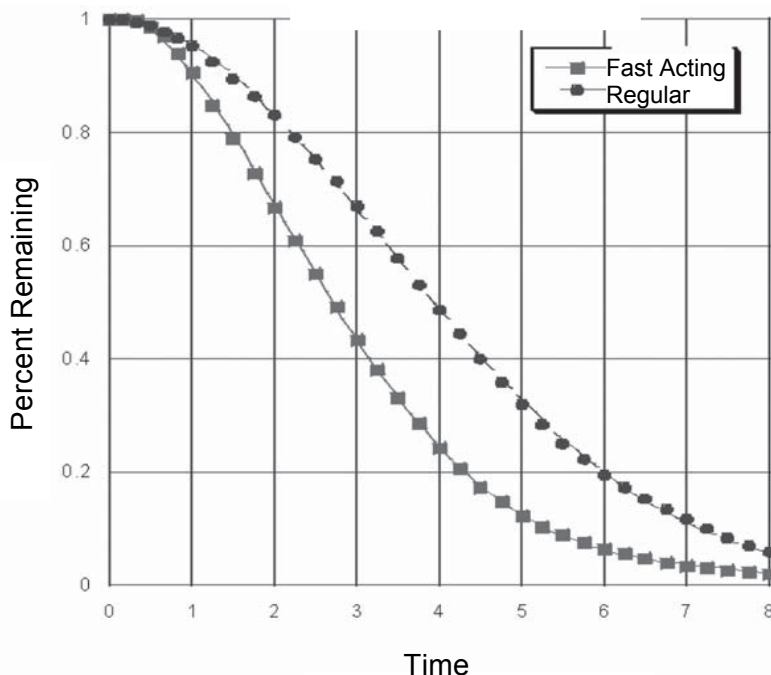

graph adapted from Mudaliar and colleagues, Diabetes Care, Volume 22, Number 9 September 1999, page 1501

- Active insulin only reduces the correction portion of the estimate, not the food portion.
- If the active insulin is more than the correction estimate, the correction portion of the estimate will be changed to zero (0).
- If the current BG is lower than target, the correction portion of the estimate will reduce the total estimate.
- If a Dual Wave bolus is less than the estimate due to the max bolus limit or user change, the square (sq) portion is reduced first.

Bolus Wizard examples: (settings:) Carb ratio: 30 grams/unit
 Insulin sensitivity: 40 mg/dL/unit
 Target BG: 120 mg/dL

#1: No previous bolus activity for at least 10 hours. User inputs 60 grams of carbs and does not enter BG.

$$\text{(food estimate)} \quad \frac{60\text{g}}{30\text{g/u}} = 2 \text{ units}$$

estimate = 2 units

#2: No previous bolus activity for at least 10 hours. User inputs 60 grams of carbs and a BG of 200.

$$\text{(food estimate)} \quad \frac{60\text{g}}{30\text{g/u}} = 2 \text{ units} \quad + \quad \text{(correction)} \quad \frac{200\text{mg/dL} - 120\text{mg/dL}}{40\text{mg/dL/u}} = 2 \text{ units}$$

$$= 2 + 2$$

$$= 4 \text{ units}$$

estimate = 4 units

#3: No previous bolus activity for at least 10 hours. User inputs 60 grams of carbs and a BG of 80.

$$\text{(food estimate)} \quad \frac{60\text{g}}{30\text{g/u}} = 2 \text{ units} \quad + \quad \text{(correction)} \quad \frac{80\text{mg/dL} - 120\text{mg/dL}}{40\text{mg/dL/u}} = \frac{-40\text{mg}}{40\text{mg}} = -1 \text{ unit}$$

$$= 2 + (-1)$$

$$= 1 \text{ unit}$$

estimate = 1 unit

#4: Previous bolus activity results in a calculation of 1.5 units unabsorbed (active) insulin.
User inputs 60 grams of carbs and a BG of 200.

(food estimate) $\frac{60\text{g}}{30\text{g/u}} = 2 \text{ units}$	+	(correction) $\frac{200\text{mg/dL} - 120\text{mg/dL}}{40\text{mg/dL/u}} - 1.5\text{mg/dL (active insulin)} = 2 - 1.5 = 0.5 \text{ units}$
--	---	---

$$= 2 + 0.5$$
$$= 2.5 \text{ units}$$

estimate = 2.5 units

#5: Previous bolus activity results in a calculation of 3.5 units unabsorbed (active) insulin.
User inputs 60 grams of carbs and a BG of 200.

(food estimate) $\frac{60\text{g}}{30\text{g/u}} = 2 \text{ units}$	+	(correction) $\frac{200\text{mg/dL} - 120\text{mg/dL}}{40\text{mg/dL/u}} - 3.5\text{mg/dL (active insulin)} = 2 - 3.5 = -1.5 \text{ units}^*$ * This negative number indicates that active insulin is sufficient to cover the correction that is needed. Thus, correction will be 0 units. Active insulin is not allowed to reduce the food portion of the estimate.
--	---	--











$$= 2 + 0$$
$$= 2.0 \text{ units}$$

estimate = 2.0 units

Default settings

Menu	Item	Default Setting	Limits	Increments	Warning Limits
Bolus Menu:	*Bolus wizard:	Off			
	Easy bolus:	On			
	Easy bolus step:	0.1 u/h	maximum bolus setting		
	Dual/Square bolus:	Off			
	Maximum bolus:	10.0 u/h	0 - 25 u (per single bolus)		
	BG reminder:	Off	0:00 - 5:00	0:30 (minutes)	
Basal Menu:	Patterns:	Off			
	Maximum basal rate:	2.0 u/h	0.00 - 35.00 u/h	0.05u	
	Basal rate:	0.0 u/h		0.05u	
	Temp basal type:	U/H	max basal rate setting	5U/H (or 5%)	(basal rate = 0.0)
Prime Menu:	Insulin type:	U100 fast acting			
Utilities Menu:	(Alarm) History:	(no defaults)			
	Alert type:	audio, beep-med			
	Auto-off:	Off			
	Low reservoir warning:	(20) insulin units	5 - 50 u; 2nd: @ 1\2 amount (2:00 - 24:00; 2nd: after 1:00)	20 u (0:30 mins)	
	(Time/Date) Time:	12 a.m. (midnight)			
	(Time/Date) Date:	1/1/03			
	(Time/Date) Time format:	12-hour			
	Block:	Off			
	Alarm clock:	Off			
	Remote option:	Off			
	Meter option:	Off			
	Language:	English			
(*Bolus Wizard settings)					
	carb units:	grams or exchanges	0 - 300 g/u or 0 - 20.0 u/exch	1 g/u or 0.5 u/exch	(none)
	ins to carb (or exch) ratio:	15 grams/u or 1 units/exch	3 - 75 g/u or 0.2 - 5.0 u/exch	1 g/u or 0.1 u/exch	5 - 50 g/u or 0.3 - 3.0 u/exch
	(insulin) sensitivity:	50 mg/dL or 2.8 mmol/L	10 - 250 mg/dL or 0.5 - 13.9 mmol/L	1 mg/dL or 0.1 mmol/L	20 - 100 mg/dL or 1.1 - 5.6 mmol/L
	BG target:	100 mg/dL or 5.6 mmol/L	80 - 160 mg/dL or 4.4 - 8.9 mmol/L	1 mg/dL or 0.1 mmol/L	90 - 140 mg/dL or 5.0 - 7.8 mmol/L

Icon table

Do not reuse:	
Attention: See Instructions for Use	
Method of sterilization using ethylene oxide:	STERILE EO
Date of manufacture (year - month):	
Manufacturer:	
Configuration:	CONF
Batch code:	LOT
Use by: (year - month)	
Catalogue number:	REF
Device serial number:	SN
Storage temperature range:	 -22°C (-7.6°F) to +57°C (+134.6°F)
Fragile product:	
Type BF equipment: (Protection from electrical shock)	
Pump: water tight Remote transmitter: splash proof	IPX7 IPX4
Recycle:	
Radio communication:	

A

accessories 2
 accessories,
 activity guard 2
 holster 2
 meter 2
 pump clip 2
 remote control 2
 ACT 8
 active insulin 53
 alarm clock 94
 Alarm conditions 109
 ALARM HISTORY screen 91
 Alarm types,
 A- alarm 109
 auto off 109
 batt out limit 109
 bolus stopped 109
 check settings 104, 109
 E- (error) 109
 empty reservoir 109
 failed batt test 110
 max delivery 110
 no delivery 103
 Alarms,
 Alarm details 91
 responding to 107
 review 91
 alert type,
 Setting your 91

alerts,
 for alert conditions,
 low battery alert 13
 low reservoir alert 13
 for special features 14
 assistance
 24-hour Product Help Line 1
 Attention mode 10
 auto-off 92

B

backlight xiii, 9
 basal delivery, current 28
 BASAL MENU 11
 basal rate,
 daily 28
 maximum 30
 patterns 77
 programming 26
 standard xvii
 stop delivery of 31
 temp 81
 battery 111, 121
 Install 6
 pump 104
 beep/vibrate, alert type 9
 BG reminder 16
 BG targets xviii, 57
 BG units 56
 Block feature,
 Turn on 96

BLOCK OPTION screen 96
 bolus
 basic 17
 details 23
 history 22
 manual 68
 maximum limit 24
 stop delivery of 31
 bolus delivery, methods for normal
 Bolus Wizard 62
 Easy Bolus 75
 express bolus 17
 from the menu 17
 remote control 2
 BOLUS MENU 11
 bolus types,
 Dual Wave 67
 Normal 17
 Square Wave 67
 Bolus Wizard xix, 49
 Bolus Wizard settings table 50
 Bolus Wizard,
 estimate details 23, 53
 examples 126
 maximum delivery 53
 on/off 54
 review settings 59
 settings,
 BG target 51
 BG units 50
 Carb ratios 50
 Carb units 50
 Insulin sensitivity 51
 specifications 125

What is it? 49
your BG reading 49
your personal settings 49
Bolus Wizard, How it works 52
buttons, pump 5, 8

C

Carb ratios xviii
Carb ratios,
 exchanges 55
 grams 55
Carb units 54
CHECK BG message 16
Child block 96
cleaning the pump 112
clear pump 99
correction bolus xviii, 17, 51, 52, 62, 63

D

DAILY TOTALS screen,
 Review 93
default settings 128
disposables 2
Dual Wave bolus programming,
 with Bolus Wizard 72
 without Bolus Wizard 68
dual/square option,
 on-off 67

E

Easy 74
Easy bolus 74
Easy bolus,
 cancel 75
 deliver an 75
 step value 74

emergency kit 1
ESC xx, 8
ESC, cancels programming 12
express bolus button 8

F

fixed prime amounts 46
food bolus 17, 50, 52, 62, 63
food entry 49, 62

G

Glossary xiii

H

high BG levels,
 Bolus Wizard and 52
HOME screen 10

I

infusion set 2, 35, 36
infusion set,
 changing your 38
Insulin sensitivity xviii, 56
Insulin type xviii
INSULIN TYPE screen 100
Insulin type, selecting your 100

L

Language setting 101
low battery alert 13
low battery,
 affects meter option 60
 affects remote control 95
 affects selftest 98
 affects your alert type 91

low BG levels,
 Bolus Wizard and 52
low reservoir alert 13
Low resv alert feature 92
Low resv alert types,
 Insulin units 93
 Time 93

M

MAIN MENU 11
MANUAL PRIME screen 41
maximum bolus limit 24
Menu map 135, 136
menus 11
meter 2, 49
meter IDs,
 add, delete, review 60
meter option 59
 rules 60
METER OPTION screen 60
meter readings 52
modes,
 Attention 10
 Normal 10
 Special 10

N

no delivery 103
Normal 62
Normal bolus programming,
 without Bolus Wizard 17
Normal mode 10
Now 73
Now portion,
 of the Dual Wave bolus 68, 73

P

Paradigm Link meter 49

Patterns,

basal 77

on/off 77

pattern A, B 77

Program a basal pattern 78

Select a basal pattern 79

standard basal pattern 77

Personal reminders 94

personal settings 49

practicing 3, 39

prime,

fixed 46

history 46

manual 41

Pump school online 3

pump,

battery cap 6

battery compartment 5

buttons 5, 8

if you remove your 14

reservoir window 5

screen 5, 9

using in water 107, 112, 124

R

Reminder, alarm clock 94

remote control 2

remote control IDs,

add, delete, review 95

Remote control option,

turn on 95

removing your pump 14

reservoir,

filling the 36

Inserting in your pump 40

low reservoir alert 92

plunger rod 36

removing the 38

transfer guard 36

tubing connector 5

reservoirs 2

rewinding your pump 39

rewinding your pump,

during practice 39

RF features,

Paradigm Link meter 2, 59

remote control 2, 94

use on aircraft 115

S

scroll bar 9

Selftest 98, 106

Special mode 10

Square portion,

of the Dual Wave bolus 73

Square Wave bolus programming,

with Bolus Wizard 72

without Bolus Wizard 68

STATUS screen 12

Step value setup 74

storage, pump 129

supplies, ordering 2

Suspend function 11, 31

T

Temp basal 14

temp basal types,

Insulin rate 82

Percent of basal 83

Temp basal,

Canceling a 85

Deliver a 84

rates 81

Selecting type 84

verify delivery 85

terms and symbols xx

therapy follow-up,

Recommended 89

time and date, setting 15

training mode 3

training mode, canceling 3

Troubleshooting 103

U

Utilities 91

UTILITIES MENU 11

W

water tight 124

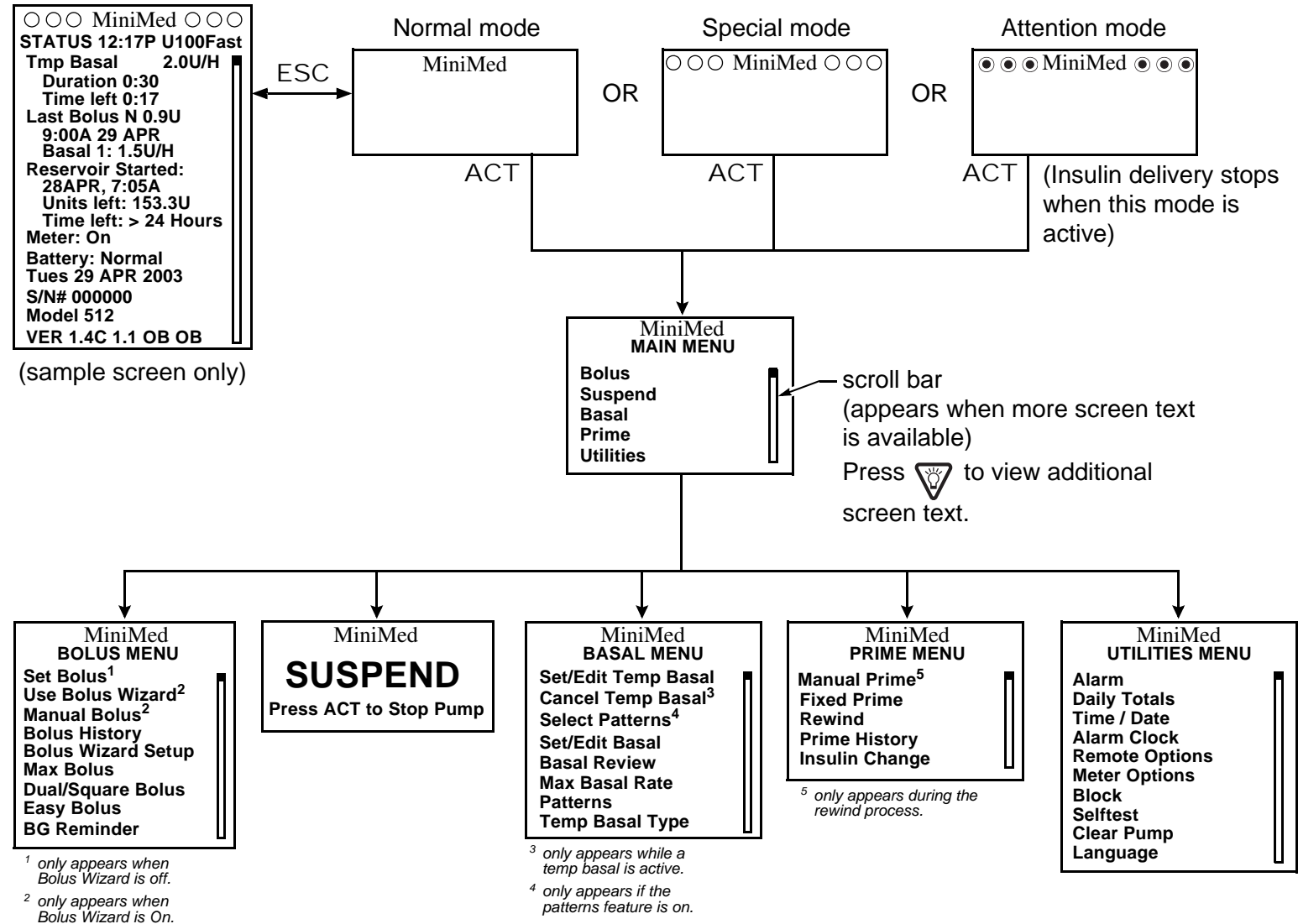

NOTE: All screens are samples only. Actual screens depend on the current active functions.

BOLUS

- Set Bolus
- Use Bolus Wizard
- Manual Bolus
- Bolus History
- Bolus Wizard Setup
 - ▷ Edit Settings
 - Wizard Off/On
 - Carb Units (grams/exch)
 - Carb Ratios
 - BG Units
 - Sensitivity
 - BG Targets
 - ▷ Review Settings
- Max Bolus
 - Max Bolus Setup
- Dual/Square Bolus
 - Off/On
- Easy Bolus Option
 - Off/On Set
- BG Reminder
 - Off/On

SUSPEND

- Press ACT to Stop Pump

BASAL

- Set/Edit Temp Basal
 - 0:30 - 24:00
- Cancel Temp Basal
- Select Patterns
 - Standard, A, B
- Set/Edit Basal
 - Standard, A, B
- Basal Review
- Max Basal Rate
 - 0 - 35
- Patterns
 - Off/On
- Temp Basal Type
 - Insulin rate U/H, Percent of basal %

PRIME

- Manual Prime
- Fixed Prime
 - 0 - 10
- Rewind
- Prime History
- Insulin Change
 - ▷ U100 Fast Acting
 - ▷ U100 Regular Acting

UTILITIES

- Alarm
 - ▷ Alarm History
 - ▷ Alert Type
 - Beep-long
 - Beep-medium
 - Beep-short
 - Vibrate
 - ▷ Auto-Off
 - (0 - 24-hours)
 - ▷ Low Resv Warning
 - Units
 - Time
- Daily Totals
- Time/Date
 - 12-hour/ 24-hour
- Alarm Clock
 - ▷ Off
 - ▷ On/Set
 - Add, Delete, Review
- Remote Options
 - ▷ Off
 - ▷ On
 - Add, Delete, Review
- Meter Options
 - ▷ Off
 - ▷ On
 - Add, Delete, Review
- Block
 - Off/On
- Selftest
- Clear Pump
 - No/Yes
- Language

