

John Lewis  
*baby*

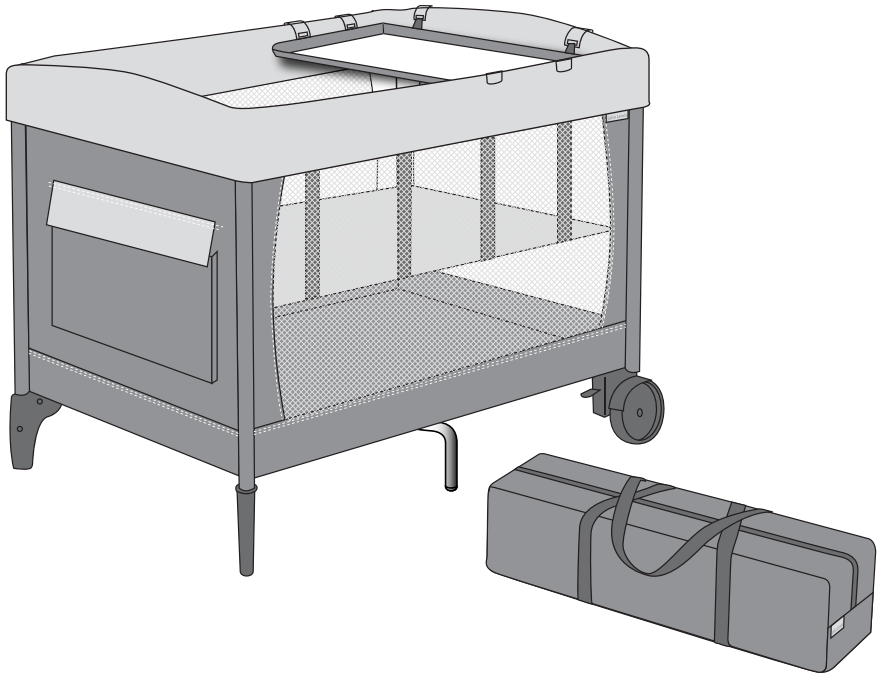

# Bassinet travel cot

## Instruction manual

**INSTRUCTIONS : RETAIN FOR FUTURE REFERENCE  
PLEASE READ CAREFULLY**

Read these instructions carefully before use and keep them for future reference. Your child's safety may be affected if you do not follow these instructions. This product is tested to EN12221:2008; EN716:2008; EN 12227:2010; EN1130:1997

This product is suitable for a child whose maximum age is 3 years old, but who does not weigh more than 13.6kg or is not more than 85cm tall

Thank you for purchasing this John Lewis Travel cot. Please read the instructions and warnings carefully before using to ensure safe and satisfactory operation of this product.

Your child's safety is your responsibility. If you have a query with this product or require replacement parts, please contact your nearest John Lewis department store.

Lay out the parts on a soft level surface and compare to the part/fixings checklist below. Do not discard any packaging until you are sure that you have all the parts.

Keep children clear during assembly as pack contains small parts which may present a choking hazard.

## Parts

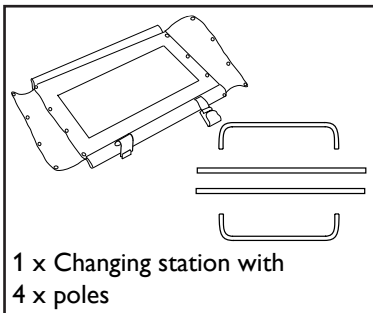
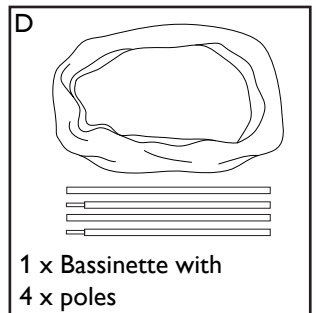
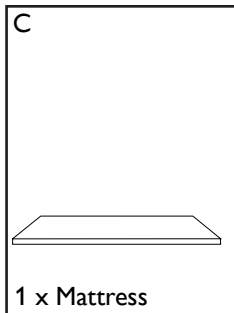
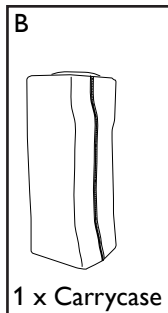
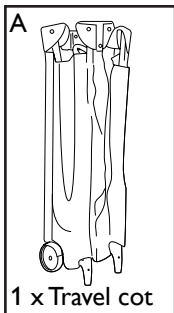

## Assembling the travel cot

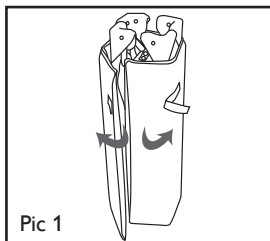

1. Unzip the travel bag and remove the frame and mattress. Place the cot in the vertical position and open the Velcro® fasteners to remove the mattress. Pic 1

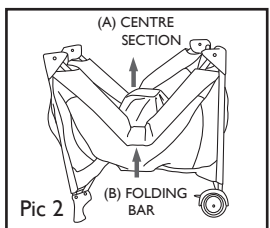

2. Spread the top corners part way out, ensuring the centre section (A) remains in the raised upright position. Pic 2  
Lift the folding bars (B) Pic 2 to the 'lock up' position and repeat on all sides.

Note: if folding bars fail to 'lock up' check that the centre section is fully raised. DO NOT use excessive force.

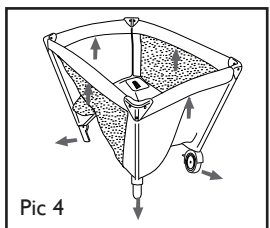

4. When all four folding bars are 'locked up', spread the legs of the cot outwards. Pic 3

Check that all four sides have engaged correctly by pressing down on each arm at the centres. If you have difficulty locking the sides, lift the centre of the base a little higher and start the process again.

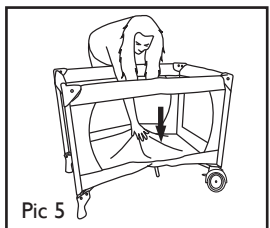

5. Gently, but firmly, push the centre of the cot base downwards until it audibly locks into place. Pic 4

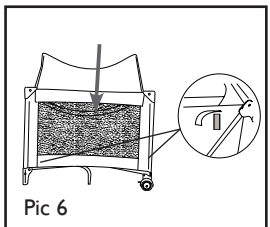

6. Place the mattress in the travel cot with the padded side up thread the touch fasteners through the eyelets of the base in all four corners and attached them to the touch fasteners on the underside of the travel cot. Pic 5

**WARNING! THE TRAVEL COT IS READY TO USE ONLY WHEN LOCKING MECHANISM OF THE FOLDING SYSTEM ON ALL SIDES (INCL. THE BASE) ARE ENGAGED FULLY AND THE MATTRESS PROVIDED IS PLACED ONTO THE BASE.**

## Installing the bassinette

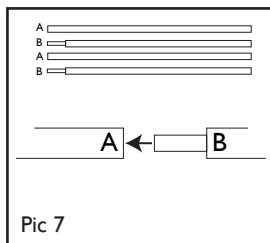

7. Assemble the 4 metal poles into pairs (B into A).

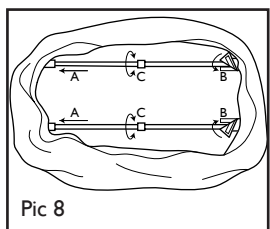

8. Insert the two assembly poles into the fixed textiles loops located inside one end of the bassinette (A). Insert the other ends of the poles into the velcro sided loops at the other end of the bassinette by opening the loops and securing them again around the poles (B). Secure the velcro tabs in the centre of the bassinette around the poles (C).

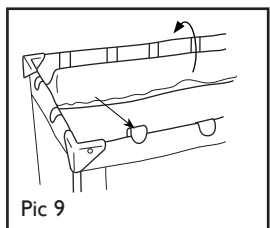

9. Place the bassinette inside the travel cot and fix it onto the 4 sides using the plastic hooks. Once fully hooked into place, fold the fabric up and over the top edge of the travel cot to conceal the hooks.

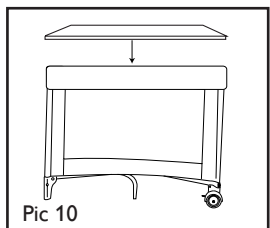

10. Place the mattress into the bassinette.

**WARNING: DO NOT** use the bassinette when the child can sit, kneel or pull itself up.

## Installing the changing table

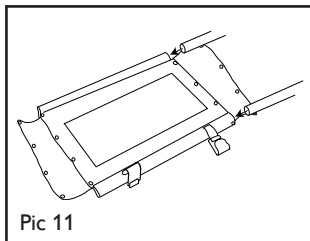

**WARNING: DO NOT** use the changing table when the child can sit, kneel, or pull itself up.

11. Insert the two long straight tubes into the channels in the changing station fabric.

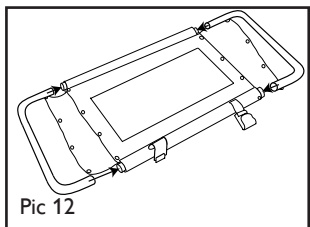

12. Join the curved end tubes to the two straight tubes.

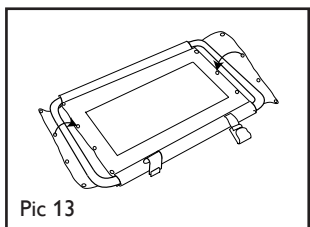

13. Fold the flaps of fabric over the tubing and fasten the poppers to secure the end tubes in place.

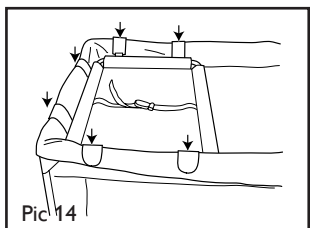

14. Clip the changing station to either end of the travel cot using all 6 clips provided. Ensure the white, wipe clean surface is facing upwards.

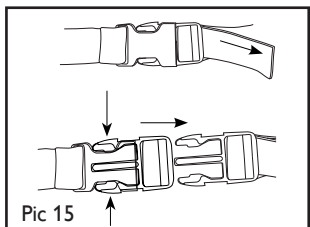

15. When the changing table is in use, the child should be secured with the waist restraint. To use the waist restraint, fasten the clips together. To adjust the waist strap, pull the webbing through the clip until the harness is tight enough to secure your child from rolling. Never over-tighten the waist strap.

## Locking the wheels

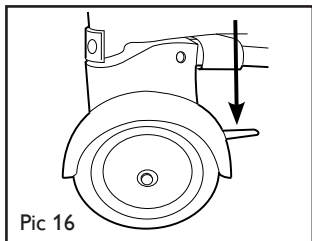

16. To lock the wheels press down brake lever as shown.

**WARNING:** Always apply the brakes when the travel cot is stationary

## Folding the Travel Cot

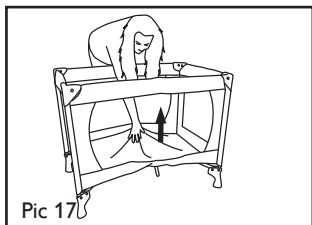

17. Remove the mattress, basinette and changing table from the travel cot. Grasp the webbing handle in the centre of the travel cot base and pull upwards fully. You will have to balance the travel cot holding one corner when moving to the next step.

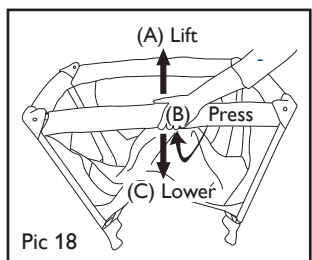

18. Hold the centre of the folding bar and lift slightly (A). Press up the release button located on the underside of the folding bar (B). Lower the bar downwards (C). Repeat on all other bars.

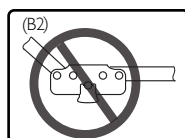
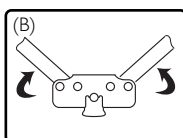
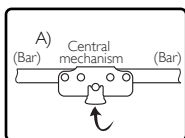

**Note:** illustration shows internal mechanism

Ensure bars on both side of the folding mechanism fold inwards (pic B). If one side remains locked (B2) raise the bar and repeat actions A and B.

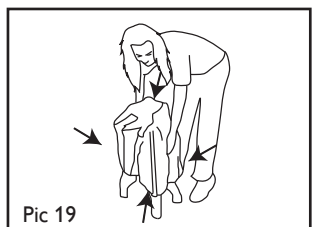

19. With the upper bars of the travel cot in the closed position push all 4 feet together.

## Cleaning and maintenance

Clean fabric covers and trims with a sponge using a mild detergent and warm water. Do not use bleach or ammonia based solvents. Dry in the open position in a well ventilated area. Clean metal parts with a damp cloth and always wipe dry. Regularly inspect for loose, damaged or missing parts. Ensure cot is thoroughly dry before using or storing.

## Safety instructions

This travel cot is intended for use as a travel cot and play pen by a child from birth to 14kg/30lbs and less than 85cm/33.5" tall, or until they can stand unaided.

Warning: your child's safety may be affected if you do not follow all instructions.

Warning: when opening or folding the travel cot, always ensure the base centre is in the raised position.

Warning: the travel cot is intended for use only by one child who is unable to climb out of it and less than 14kg/30lbs in weight and less than 85cm/33.5" in height.

Warning: to prevent injury from falls, do not continue to use this product if the child is able to climb out of the cot.

Warning: ensure locking mechanism of the folding system on all sides (incl. the base) are engaged fully and the mattress provided is placed onto the base.

Warning: for correct and safe fitting, the mattress to be used with this cot should not be more than 910mm in length, 620mm in width and 20mm in height, which is provided.

Warning: do not use travel cot if any part is broken, torn or missing.

Warning: do not leave anything in the cot or place cot close to another product, which could provide a foot hold or present a danger of suffocation or strangulation, e.g. strings, blind/curtain cords etc.

Warning: be aware of the risk of open fire and other sources of strong heat such as electric bar fires, gas fires, hot radiators etc, in the vicinity of the cot.

Warning: do not move the travel cot while the child is inside.

Warning: never sit or lean on the top rails.

Warning: do not use more than one mattress in the cot.

Warning: Only use spare parts approved by the manufacturer.

John Lewis Partnership

171 Victoria Street

London SW1E 5NN

[www.johnlewis.com](http://www.johnlewis.com)

Helpline: 0161 335 2508