

RICOH

SLR Digital Camera

PENTAX *K-70*

Start Guide

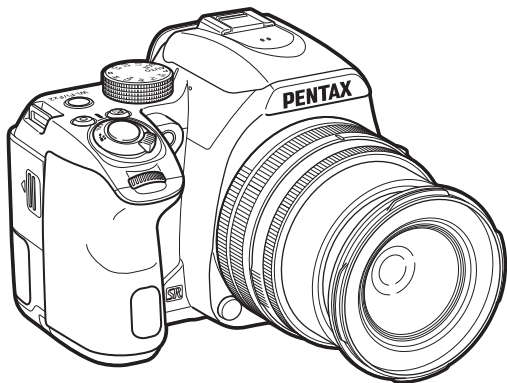

Thank you for purchasing the PENTAX K-70 digital camera.

This Start Guide provides information on how to get your PENTAX K-70 ready for use and its basic operations. To ensure proper operation, please read this Start Guide before using the camera.

For details on how to use the various shooting methods and settings, please refer to the Operating Manual (PDF) posted on our website. Refer to p.68 for details on the Operating Manual.

For Using Your Camera Safely

We have paid close attention to the safety of this camera. When using this camera, we request your special attention regarding items marked with the following symbols.



Warning

This symbol indicates that ignoring this item could cause serious personal injuries.



Caution

This symbol indicates that ignoring this item could cause minor or medium personal injuries, or loss of property.

About the Camera



Warning

- Do not disassemble or modify the camera. High voltage areas are present inside the camera, with the risk of electric shock.
- If the camera interior is exposed due to dropping or otherwise damaging the camera, never touch the exposed portion. There is a risk of electric shock.
- Do not aim the camera at the sun or other strong light sources when taking pictures or leave the camera sitting in direct sunlight with a lens cap off. Doing so may cause the camera to malfunction or cause a fire.
- Do not look at the sun or other strong light sources through a lens. Doing so may lead to a loss of eyesight or cause vision to be impaired.
- If any irregularities occur during use, such as smoke or a strange odor, stop using the camera immediately, remove the battery or the AC adapter, and contact your nearest service center. Continued use can cause a fire or electric shock.



Caution

- Do not place your finger over the flash when discharging the flash. You may burn yourself.
- Do not cover the flash with clothing when discharging the flash. Discoloration may occur.
- Some portions of the camera heat up during use. There is a risk of low temperature burns when holding such portions for long periods.

- Should the monitor be damaged, be careful of glass fragments. Also, be careful not to allow the liquid crystal to get on your skin or in your eyes or mouth.
- Depending on your individual factors or physical condition, the use of the camera may cause itching, rashes or blisters. In case of any abnormality, stop using the camera and get medical attention immediately.

About the Battery Charger and AC Adapter



Warning

- Always use the battery charger and AC adapter exclusively developed for this camera, with the specified power and voltage. Using a battery charger or AC adapter not exclusive to this camera, or using the exclusive battery charger or AC adapter with an unspecified power or voltage can cause a fire, electric shock, or camera breakdown. The specified voltage is 100 - 240V AC.
- Do not disassemble or modify the product. This can cause a fire or electric shock.
- If the generation of smoke or strange odor from the product or other abnormality occurs, immediately discontinue using and consult your nearest service center. Continued use can cause a fire or electric shock.
- If water should happen to get inside the product, consult your nearest service center. Continued use can cause a fire or electric shock.
- If you see a lightning flash or hear thunder during use of the battery charger or AC adapter, unplug the power plug and discontinue using. Continued use can cause damage to the product, fire or electric shock.
- Wipe off the power plug if it should become covered with dust. Accumulated dust may cause a fire.
- To reduce the risk of hazards, use only CSA/UL certified power supply cord set, cord is Type SPT-2 or heavier, minimum NO.18 AWG copper, one end with a molded-on male attachment plug cap (with a specified NEMA configuration), and the other is provided with a molded-on female connector body (with a specified IEC nonindustrial type configuration) or the equivalent.



Caution

- Do not place or drop heavy objects on or forcefully bend the AC plug cord. Doing so may damage the cord. Should the AC plug cord be damaged, consult your nearest service center.

- Do not touch or short-circuit the terminal area of the AC plug cord while the cord is plugged in.
- Do not handle the power plug with wet hands. This can cause an electric shock.
- Do not drop the product, or subject it to violent impact. This can cause the product to breakdown.
- Do not use the battery charger D-BC109 to charge batteries other than the rechargeable lithium-ion battery D-LI109. Attempting to charge other types of batteries may cause an explosion or heating, or may damage the battery charger.

About the Rechargeable Lithium-ion Battery

Warning

- If any leakage from the battery should come in contact with your eyes, do not rub them. Flush your eyes with clean water and get medical attention immediately.

Caution

- Only use the specified battery with this camera. Use of other batteries may cause an explosion or fire.
- Do not disassemble the battery. Disassembling the battery may cause an explosion or leakage.
- Remove the battery from the camera immediately if it becomes hot or begins to smoke. Be careful not to burn yourself during removal.
- Keep wires, hairpins, and other metal objects away from the + and - contacts of the battery.
- Do not short the battery or dispose of the battery in fire. This can cause an explosion or fire.
- If any leakage from the battery should come in contact with skin or clothing, it may cause irritation to the skin. Wash the affected areas thoroughly with water.
- Precautions for D-LI109 Battery Usage:
 - USE SPECIFIED CHARGER ONLY.
 - DO NOT INCINERATE.
 - DO NOT DISASSEMBLE.
 - DO NOT SHORT CIRCUIT.
 - DO NOT EXPOSE TO HIGH TEMP. (140°F / 60°C)

Keep the Camera and its Accessories out of the Reach of Small Children

Warning

- Do not place the camera and its accessories within the reach of small children.
 1. If the product falls or is operated accidentally, it may cause serious personal injuries.
 2. Wrapping the strap around a neck may cause suffocation.
 3. To avoid the risk of a small accessory such as the battery or memory cards from being swallowed by mistake, keep them out of the reach of small children. Seek medical attention immediately if an accessory is accidentally swallowed.

Checking the Contents of the Package



Hot shoe cover Fk
(Installed on camera)



Eyecup Fr
(Installed on camera)

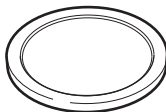

Body mount cover
(Installed on camera)

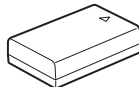

Rechargeable lithium-ion
battery D-L1109

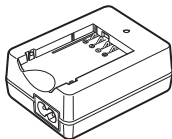

Battery charger
D-BC109



AC plug cord

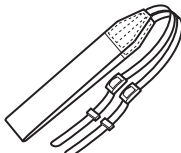

Strap
O-ST132

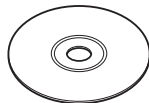

Software (CD-ROM)
S-SW168



Start Guide (this manual)

Lenses you can use

Lenses that can be used with this camera are DA, DA L, D FA, FA J, and FA lenses and lenses that have an **A** (Auto) position on the aperture ring. To use any other lens or accessory, see p.48.

Contents

Checking the Contents of the Package	2
Names and Functions of the Working Parts	5
Operating Controls	6
Monitor	8
Viewfinder	11
Electronic Level	11
How to Change Function Settings	12
Using the Direct Keys	12
Using the Control Panel	12
Using the Menus	14
Menu List	15
Rec. Mode Menus	15
Movie Menus	20
Playback Menu	21
Set-up Menus	22
Custom Setting Menu	25
Getting Your Camera Ready for Use	27
Attaching the Strap	27
Attaching a Lens	27
Charging the Battery	28
Inserting/Removing the Battery	28
Inserting/Removing a Memory Card	29
Opening the Monitor	29
Setting the Display Language and Date/Time	30
Formatting a Memory Card	31
Basic Shooting Operation	32
Shooting with the Viewfinder	32
Shooting while Viewing the Live View Image	33
Capture Modes for Still Pictures	34
Setting the Sensitivity	37
Compensating the Exposure	37
Recording Movies	38
Using the Built-in Flash	39
Setting the Drive Mode	40
Setting the White Balance	41
Reviewing Images	41
Playing Back Movies	42
Playback Mode Palette	43
Sharing Images	44
Enabling the Wi-Fi Function	44
Operating the Camera with a Communication Device	44
Restrictions on Each Capture Mode	45
Restrictions on the Combinations of Special Functions	47
Functions Available with Various Lenses	48
Main Specifications	49
Operating Environment for USB Connection and Provided Software	54
Index	56
Care to be Taken During Handling	59
WARRANTY POLICY	63
Information on the Operating Manual	68

There is a possibility that the illustrations and the display screen of the monitor in this manual are different from the actual ones.

Regarding copyrights

Images taken with this camera that are for anything other than personal enjoyment cannot be used without permission according to the rights as specified in the Copyright Act. Please take care, as there are cases where limitations are placed on taking pictures even for personal enjoyment during demonstrations, performances or of items on display. Images taken with the purpose of obtaining copyrights also cannot be used outside the scope of use of the copyright as laid out in the Copyright Act, and care should be taken here also.

To users of this camera

- Do not use or store this camera in the vicinity of equipment that generates strong electromagnetic radiation or magnetic fields. Strong static charges or the magnetic fields produced by equipment such as radio transmitters could interfere with the monitor, damage the stored data, or affect the camera's internal circuitry and cause camera misoperation.
- The liquid crystal panel used for the monitor is manufactured using extremely high precision technology. Although the level of functioning pixels is 99.99% or better, you should be aware that 0.01% or fewer of the pixels may not light up or may light up when they should not. However, this has no effect on the recorded image.
- In this manual, the generic term "computer(s)" refers to either a Windows PC or a Macintosh.
- In this manual, the term "battery(ies)" refers to any type of batteries used for this camera and its accessories.

Regarding User Registration

In order to better serve you, we request that you complete the user registration, which can be found on the CD-ROM supplied with the camera or on our website. Thank you for your cooperation.





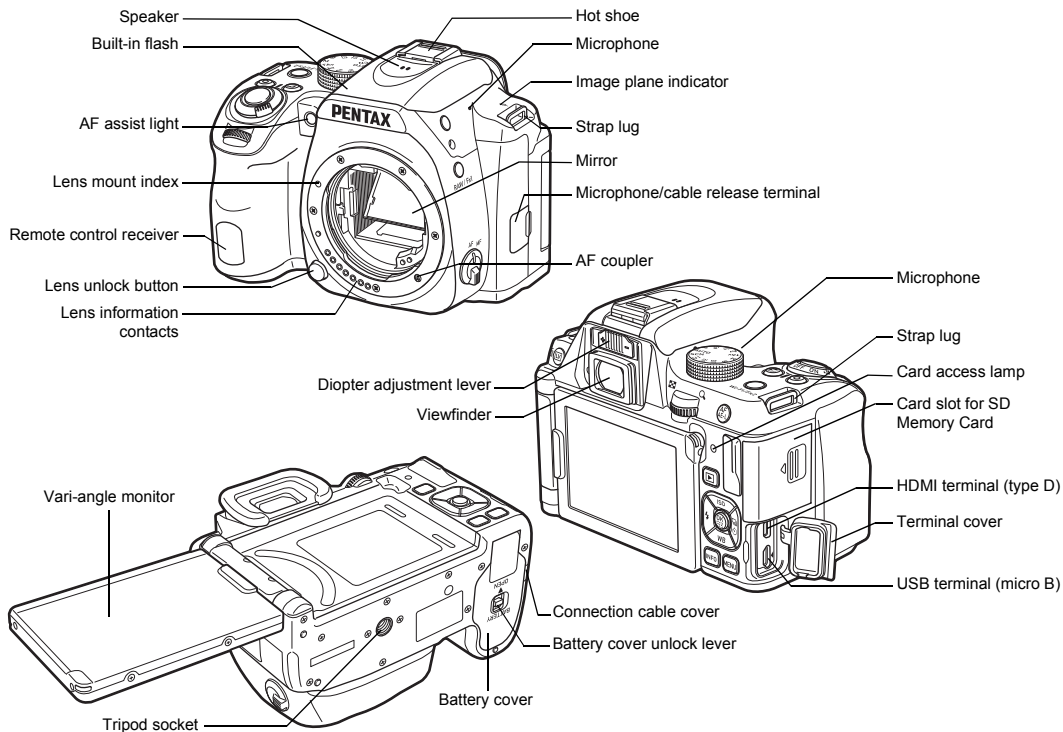



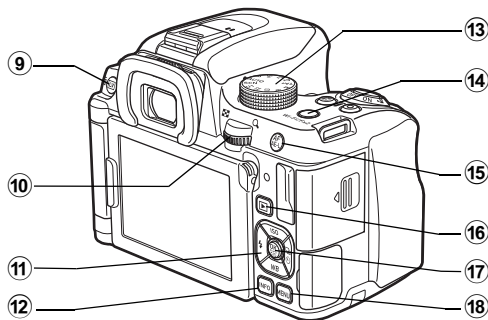
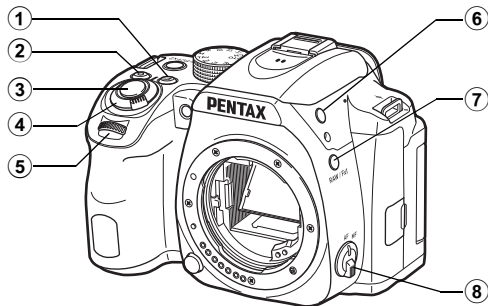

<http://www.ricoh-imaging.com/registration/>

Names and Functions of the Working Parts



Operating Controls



- EV Compensation button ()**
Press to change the exposure compensation value. (p.37)
In playback mode, press to save the last JPEG image taken also in RAW format.
- Green button ()**
Resets the value being adjusted.
- Shutter release button ()**
Press to capture images. (p.33)
In playback mode, press halfway to switch to capture mode.
- Main switch**
Turns the power on or off, or switches to  (movie) mode. (p.38)
When the camera is turned on, it enters  (still picture) mode and the indicator lamp lights green. When the switch is turned to , the camera enters  mode and the lamp lights red.
- Front e-dial ()**
Changes the values for camera settings such as exposure. (p.36)
You can change the menu category when a menu screen is displayed. (p.14)
In playback mode, use this to select a different image.
- Flash pop-up button ()**
Press to pop up the built-in flash. (p.39)
- RAW/Fx1 button ()**
You can assign a function to this button.
By default, the function that temporarily changes the file format (One Push File Format) is assigned.
- Focus mode switch**
Changes the focus method. (p.32)

- ⑨ **Live View/Delete button (LV/📷)**
 Displays the Live View image. (p.33)
 In playback mode, press to delete images. (p.42)
- ⑩ **Rear e-dial (📷)**
 Changes the values for camera settings such as exposure. (p.36)
 You can change the menu tabs when a menu screen is displayed. (p.14)
 You can change camera settings when the control panel is displayed. (p.12)
 In playback mode, use this to magnify the image or display multiple images at the same time. (p.42)
- ⑪ **Four-way controller (▲▼◀▶)**
 Displays the Sensitivity, White Balance, Flash Mode or Drive Mode setup menu. (p.12)
 When a menu or the control panel is displayed, use this to move the cursor or change the item to set.
 Press ▼ in single image display of the playback mode to display the playback mode palette. (p.43)
- ⑫ **INFO button (INFO)**
 Changes the style of the display on the monitor. (p.8, p.10)
- ⑬ **Mode dial**
 Changes the capture mode. (p.32, p.34)
- ⑭ **Wi-Fi/Fx2 button (Fx2)**
 You can assign a function to this button.
 In playback mode, press to turn the Wi-Fi function on or off. (p.44)
- ⑮ **AF/AE Lock button (AF/AE-L)**
 Available for adjusting focus, instead of pressing **SHUTTER** halfway, and for locking the exposure value before shooting.
- ⑯ **Playback button (📷)**
 Switches to playback mode. (p.41) Press the button again to switch to capture mode.

- ⑰ **OK button (OK)**
 When a menu or the control panel is displayed, press this button to confirm the selected item.
 Press and hold this button when [AF Active Area] is set to **AREA** or **AREA**, or to **AREA** or **AREA** to switch the function of the arrow keys to the AF area change mode or the direct key operation mode.
- ⑱ **MENU button (MENU)**
 Displays a menu. Press this button while the menu is displayed to return to the previous screen. (p.14)

About the Four-way Controller

In this manual, each button of the four-way controller is indicated as shown in the illustration on the right.

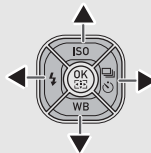

Monitor

Capture Mode

With this camera, you can take pictures while looking through the viewfinder or while viewing the image on the monitor. When using the viewfinder, you can take pictures while checking the status screen displayed on the monitor and looking through the viewfinder. (p.32) When not using the viewfinder, you can take pictures while viewing the Live View image displayed on the monitor. (p.33)

The camera is in “standby mode” when it is ready to shoot, such as when the status screen or Live View image is displayed. Press **INFO** in standby mode to display the “control panel” and change settings. (p.12) You can change the type of information displayed in standby mode by pressing **INFO** while the control panel is displayed.

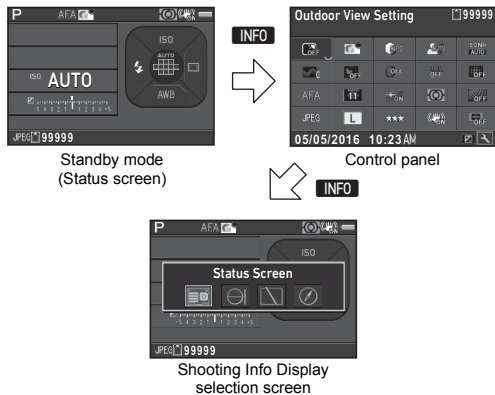

Status Screen

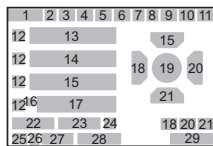
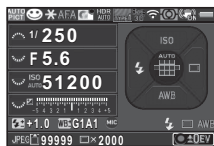

- | | |
|---|---|
| 1 Capture mode | 17 EV bar scale |
| 2 AE Lock | 18 Flash Mode |
| 3 Focus Method | 19 Focusing area (AF point) |
| 4 Custom Image | 20 Drive Mode |
| 5 Clarity/Skin Tone/Digital Filter/HDR Capture/Pixel Shift Resolution | 21 White Balance |
| 6 AA Filter Simulator | 22 Flash Exposure Compensation |
| 7 GPS positioning status | 23 White Balance fine-tuning |
| 8 Wi-Fi connection status | 24 External Input Devices |
| 9 AE Metering | 25 File Format |
| 10 Shake Reduction/ Horizon Correction | 26 Memory card |
| 11 Battery level | 27 Number of recordable still pictures/Movie recordable time |
| 12 E-dial guide | 28 Number of shots during Multi-exposure or Interval Shooting |
| 13 Shutter speed | 29 Operation guide |
| 14 Aperture value | |
| 15 Sensitivity | |
| 16 EV Compensation/ Bracketing | |

Live View



- | | |
|---|--|
| 1 Capture mode | 16 Electronic Level (vertical tilt) |
| 2 Flash Mode | 17 EV Compensation |
| 3 Drive Mode | 18 EV bar scale |
| 4 White Balance | 19 Operation guide, and number of shots during Multi-exposure or Interval Shooting |
| 5 Custom Image | 20 AE Lock |
| 6 Clarity/Skin Tone/Digital Filter/HDR Capture/Pixel Shift Resolution | 21 Shutter speed |
| 7 Wi-Fi connection status | 22 Aperture value |
| 8 AE Metering | 23 Sensitivity |
| 9 Shake Reduction/ Horizon Correction/ Movie SR | 24 File Format |
| 10 Battery level | 25 Memory card |
| 11 External Input Devices | 26 Number of recordable still pictures/Movie recordable time |
| 12 GPS positioning status | 27 Face detection frame (when [AF Active Area] is set to [Face Detection]) |
| 13 Temperature warning | |
| 14 Histogram | |
| 15 Electronic Level (horizontal tilt) | |

Control Panel

mode

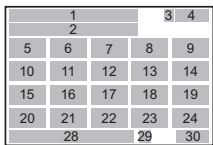
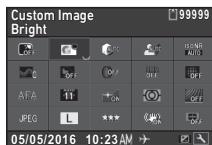

mode

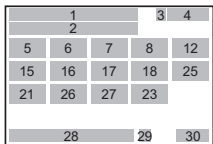
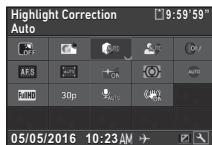

- | | |
|---|--|
| 1 Function name | 15 AF Mode |
| 2 Setting | 16 AF Active Area |
| 3 Memory card | 17 AF Assist Light |
| 4 Number of recordable still pictures/Movie recordable time | 18 AE Metering |
| 5 Outdoor View Setting | 19 AA Filter Simulator |
| 6 Custom Image | 20 File Format |
| 7 Highlight Correction | 21 JPEG Recorded Pixels/ Movie Recorded Pixels |
| 8 Shadow Correction | 22 JPEG Quality |
| 9 High-ISO NR | 23 Shake Reduction/Movie SR |
| 10 Clarity | 24 Horizon Correction |
| 11 Skin Tone | 25 External Input Devices |
| 12 Digital Filter | 26 Framerate |
| 13 HDR Capture | 27 Recording Sound Level |
| 14 Pixel Shift Resolution | 28 Current date and time |

29 Destination

30 Operation guide for the control panel customization

Playback Mode

The captured image and shooting information are displayed in single image display of the playback mode.

Press **INFO** to change the type of information displayed in single image display.



Single image display
(Standard Information Display)



Playback Info Display selection
screen

Viewfinder

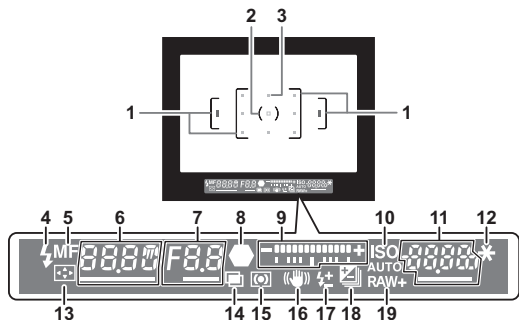

- | | |
|--|--|
| 1 AF frame | 10 ISO/ISO AUTO |
| 2 Spot metering frame | 11 Sensitivity/Exposure compensation value |
| 3 AF point | 12 AE Lock |
| 4 Flash indicator | 13 Change AF Area |
| 5 Focus Method | 14 Multi-exposure |
| 6 Shutter speed/Exposure time for timed exposure in B mode/Number of shots for Bracketing | 15 AE Metering |
| 7 Aperture value/Bracket value for Bracketing | 16 Shake Reduction |
| 8 Focus indicator (p.33) | 17 Flash Exposure Compensation |
| 9 EV bar scale/Electronic Level | 18 EV Compensation/Bracketing |
| | 19 File Format |

Memo

- You can adjust the viewfinder image sharpness using the diopter adjustment lever. If it is difficult to move the diopter adjustment lever, lift up and remove the eyecup. Adjust the diopter setting until the AF frame in the viewfinder looks sharp and clear.

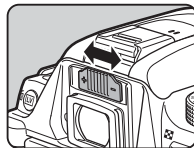

Electronic Level

You can check whether the camera is tilted by displaying electronic levels. The electronic level for the horizontal camera angle can be displayed in the viewfinder, and the electronic levels for the vertical and horizontal camera angles can be displayed on the Live View screen. (p.9)

How to Change Function Settings

Using the Direct Keys

Press ▲▼◀▶ in standby mode.

▲	Sensitivity	p.37
▼	White Balance	p.41
◀	Flash Mode	p.39
▶	Drive Mode	p.40

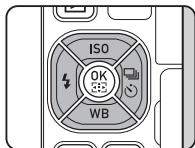

Using the Control Panel

Press **INFO** in standby mode.

Use ▲▼◀▶ to select an item.

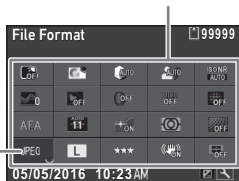

Use  to change settings.

Press **OK** to make detailed settings.

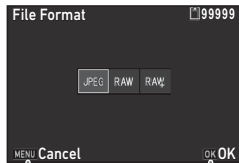



Press **MENU** to cancel the setting operation.

Press **OK** to confirm the selected item and return to the control panel.

Customizing the Control Panel

The functions displayed on the control panel can be customized.

Some functions in the , , and  menus can be saved on the control panel. Refer to "Menu List" (p.15) for details on the functions that can be saved.

1 Press **INFO** in standby mode.

The control panel appears.

2 Press .

The customization screen appears.

3 Use **▲▼◀▶** to select the function to change.

Press  to reset to the default settings.

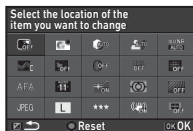

4 Press **OK**.

Selectable functions are displayed in the pop-up menu.

5 Use **▲▼** to select the function to save.

Select [-] if you do not want to save any function.

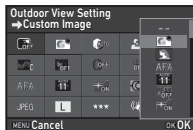

6 Press **OK**.

The screen of Step 3 reappears.

7 Press .

The control panel reappears.

8 Press **MENU**.

The camera returns to standby mode.

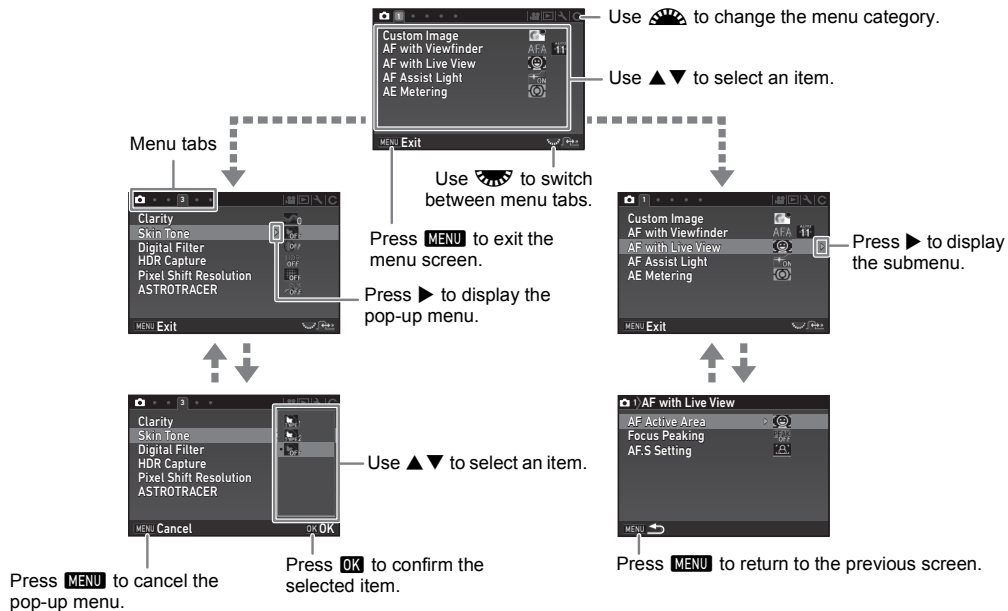

Using the Menus











Menu List

Rec. Mode Menus

Menu	Item	Function	Default Setting	
	Custom Image *1 *2	Sets the image finishing tone such as color and contrast before shooting an image.	Bright	
	Scene Mode *1 *3	Selects the scene mode that best suits the situation. (SCN mode)	Portrait	
	AF with Viewfinder	AF Mode *1	Selects the AF mode for shooting with the viewfinder.	AF.A
		AF Active Area *1	Selects the area to adjust the focus for shooting with the viewfinder.	Auto (11 AF Points)
		AF.S Setting	Sets the action priority for when the autofocus mode is set to AF.S and SHUTTER is fully pressed.	Focus-priority
		1st Frame Action in AF.C	Sets the action priority for the first frame when the autofocus mode is set to AF.C and SHUTTER is fully pressed.	Auto
		Action in AF.C Cont.	Sets the action priority during Continuous Shooting when the autofocus mode is set to AF.C .	Auto
		Hold AF Status	Maintains the focus for a certain amount of time when the subject happens to move out of the selected focusing area after being focused.	Low
	AF with Live View	AF Active Area *1	Selects the area to adjust the focus for shooting with Live View.	Face Detection
		Focus Peaking *1	Emphasizes the outline of the subject in focus and makes it easier to check the focus.	Off
		AF.S Setting	Sets the action priority for when SHUTTER is fully pressed.	Focus-priority
	AF Assist Light *1	Discharges the assist light when autofocusing in dark locations.	On	
	AE Metering *1	Selects the part of the sensor to use for measuring brightness and determining the exposure.	Multi-segment	
Exposure Mode *4	Temporarily changes the exposure mode when the mode dial is set to one of the modes from U1 to U3 .	—		

Menu	Item	Function	Default Setting	
 2	Image Capture Settings	File Format *1	Sets the file format of images.	JPEG
		JPEG Recorded Pixels *1	Sets the recording size of JPEG images.	<input type="checkbox"/>
		JPEG Quality *1	Sets the quality of JPEG images.	★★★
		RAW File Format	Sets the RAW file format.	PEF
		Color Space	Sets the color space to use.	sRGB
	D-Range Settings	Highlight Correction *1	Expands the dynamic range and prevents overexposed areas from occurring.	Auto
		Shadow Correction *1	Expands the dynamic range and prevents underexposed areas from occurring.	Auto
	Noise Reduction	Slow Shutter Speed NR *1	Sets the Noise Reduction setting when shooting with a slow shutter speed.	Auto
High-ISO NR *1		Sets the Noise Reduction setting when shooting with a high ISO sensitivity.	Auto	
 3	Clarity *1		Changes the clarity of images using an image processing program.	±0
	Skin Tone *1		Enhances the skin tone of the subject in the image using an image processing program.	Off
	Digital Filter *1		Applies a digital filter effect when taking pictures.	No Filter
	HDR Capture *1		Sets the type of high dynamic range shooting.	Off, ±2EV, On
	Pixel Shift Resolution *1		Merges four images shifted pixel by pixel and outputs a high-definition image.	Off
	ASTROTRACER *1		Makes settings to track and capture celestial bodies.	Off

Menu	Item	Function	Default Setting	
 4	AA Filter Simulator *1	Applies a low-pass filter effect using the Shake Reduction mechanism.	Off	
	Shake Reduction *1	Activates the Shake Reduction function.	On	
	Horizon Correction *1	Corrects horizontal tilt when in  mode.	Off	
	Lens Correction	Distortion Correction *1	Reduces distortions occurring due to lens properties.	Off
		Peripheral Illumin. Corr. *1	Reduces peripheral light fall-off occurring due to lens properties.	Off
		Lat-Chromatic-Ab Adj *1	Reduces lateral chromatic aberrations occurring due to lens properties.	On
		Diffraction Correction *1	Corrects blur caused by diffraction when using a small aperture.	On
Input Focal Length *1	Sets the focal length when using a lens of which focal length information cannot be obtained.	35mm		
 5	Viewfinder Overlay	Electronic Level *1	Displays the electronic level at the bottom of the viewfinder.	Off
		Superimpose AF Area	Displays the active AF point in red in the viewfinder.	On
	Live View	Grid Display *1	Sets the type and color of the grid lines displayed during Live View.	Off, Black
		Electronic Level *1	Displays the electronic level during Live View.	On
		Histogram Display	Displays the histogram during Live View.	Off
		Highlight Alert	Sets overexposed areas to blink red during Live View.	Off
		Flicker Reduction	Cuts down on the Live View screen flicker by setting the power frequency.	50Hz

Menu	Item		Function	Default Setting	
5	Instant Review	Display Time	Sets the Instant Review display time.	1sec.	
		Zoom Review	Displays the magnified image during Instant Review.	On	
		Save RAW Data	Saves the RAW data during Instant Review.	On	
		Delete	Deletes the displayed image during Instant Review.	On	
		Histogram Display	Displays the histogram during Instant Review.	Off	
		Highlight Alert	Sets overexposed areas to blink red during Instant Review.	Off	
	Other Display Settings	Guide Display	Displays operation guides when the capture mode is changed.	On	
		Display Color	Sets the display color of the status screen, control panel, and menu cursor.	1	
	Button Customization	Fx1 Button		Sets the function for when Fx1 is pressed.	One Push File Format
		Fx2 Button		Sets the function for when Fx2 is pressed.	Wi-Fi
		AF/AE-L Button		Sets the function for when AF/AE-L is pressed.	Enable AF1
		E-Dial Programming	P	Sets the  /  /  operation for each exposure mode.	Tv, Av, P
			Sv		-, ISO, -
Tv			Tv, -, -		
Av			-, Av, -		
TAv			Tv, Av, P LINE		
M	Tv, Av, P LINE				
Rotation Direction		Reverses the effect obtained when  or  is turned.	Rotate Right		

Menu	Item	Function	Default Setting	
 5	Memory	Sensitivity	Determines which settings to save when the power is turned off.	On
		EV Compensation		On
		Flash Mode		On
		Flash Exposure Comp.		On
		Drive Mode		On
		White Balance		On
		Custom Image		On
		Clarity		Off
		Skin Tone		Off
		Digital Filter		Off
		HDR Capture		Off
		Pixel Shift Resolution		Off
		Shooting Info Display		Off
		Playback Info Display		On
	Outdoor View Setting	Off		
	Night Vision LCD Display	Off		
	Save USER Mode	Save Settings	You can save frequently used capture settings to U1 to U3 of the mode dial.	CLEAR TONE, HDR LANDSCAPE, ASTROPHOTO
		Rename USER Mode	Changes the names of the saved USER modes to display on the monitor.	CLEAR TONE, HDR LANDSCAPE, ASTROPHOTO
		Check Saved Settings	Displays the settings saved in USER modes.	-
Reset USER Mode		Resets all the settings saved in USER modes to the defaults.		



*1 Available as a function in the control panel.









*2 The function appears in modes other than **SCN** mode.

*3 The function appears in **SCN** mode.

*4 The function appears only in **U1** to **U3** modes.

Movie Menus

Menu	Item	Function	Default Setting	
	Custom Image *1	Sets the image finishing tone such as color and contrast before shooting an image.	Bright	
	AF with Live View	AF Mode	Selects the AF mode for movie recording.	AFS
		AF Active Area *1	Selects the area to adjust the focus for movie recording.	Multiple AF Points
		Focus Peaking *1	Emphasizes the outline of the subject in focus and makes it easier to check the focus.	Off
	AF Assist Light *1	Discharges the assist light when autofocusing in dark locations.	On	
	AE Metering *1	Selects the part of the sensor to use for measuring brightness and determining the exposure.	Multi-segment	
	Movie Capture Settings	Recorded Pixels *1	Sets the number of recorded pixels of the movie.	
		Framerate *1	Sets the framerate of the movie.	30p
	Recording Sound Level *1	Sets the sound level for recording.	Auto	
	D-Range Settings	Highlight Correction *1	Expands the dynamic range and prevents overexposed areas from occurring.	Auto
		Shadow Correction *1	Expands the dynamic range and prevents underexposed areas from occurring.	Auto
	Digital Filter *1	Applies a digital filter effect when recording a movie.	No Filter	
	Movie SR *1	Activates the Shake Reduction function.	On	
	Live View	Grid Display *1	Sets the type and color of the grid lines displayed during Live View.	Off, Black
		Electronic Level *1	Displays the electronic level during Live View.	On
		Histogram Display	Displays the histogram during Live View.	Off
		Highlight Alert	Sets overexposed areas to blink red during Live View.	Off
Flicker Reduction		Cuts down on the Live View screen flicker by setting the power frequency.	50Hz	

Menu	Item		Function	Default Setting
2 Button Customization	AF/AE-L Button		Sets the function for when AF/AE-L is pressed.	Enable AF1
	E-Dial Programming	 P/Av	Sets the  /  /  operation for each exposure mode.	-, -, -
		 P/Av		-, Av , P LINE
		 P/Av		Tv , Av , P LINE
		 P/Av		Tv , Av , P LINE
Rotation Direction		Reverses the effect obtained when  or  is turned.	Rotate Right	

*1 Available as a function in the control panel.





Playback Menu

Menu	Item		Function	Default Setting
1 ▶	Slideshow	Display Duration	Sets an image display interval.	3sec.
		Screen Effect	Sets a transition effect when the next image is displayed.	Off
		Repeat Playback	Starts a slideshow again from the beginning after the last image is displayed.	Off
		Auto Movie Playback	Plays back movies during a slideshow.	On
	Protect All Images		Protects all stored images at once.	-
	Delete All Images		Deletes all stored images at once.	-
	Quick Zoom		Sets the initial magnification when magnifying images.	Off
	Playback Sound Volume		Sets the sound volume during movie playback.	10
	LCD Display	Auto Image Rotation	Rotates images which were captured with the camera held vertically or of which the rotation information has been changed.	On
		Grid Display	Sets the type and color of grid lines.	Off, Black
Highlight Alert		Sets overexposed areas to blink red in Standard Information Display, Histogram Display, and No Information Display of the playback mode.	Off	

Set-up Menus

Menu	Item	Function	Default Setting	
1	Language/言語	Changes the display language.	English	
	Date Adjustment	Sets the date and time and the display format.	01/01/2016	
	World Time	Switches between the date and time display of your hometown city and that of a specified city.	Hometown	
	Text Size	Magnifies the text size when selecting a menu item.	Std.	
	Sound Effects	Volume	Sets the sound volume of beep sounds.	3
		In-focus	Sets whether to make a beep sound when the subject is focused.	On
		AE-L	Sets whether to make a beep sound when the exposure value is locked with AF/AE-L .	On
		Self-timer	Sets whether to make a beep sound during the countdown for Self-timer shooting.	On
		Remote Control	Sets whether to make a beep sound during the countdown for Remote Control shooting.	On
		Mirror Up	Sets whether to make a beep sound during Mirror Lock-up Shooting.	On
		Change AF Area	Sets whether to make a beep sound when the function of the arrow keys (▲▼◀▶) is switched to the AF area change mode.	On
		One Push File Format	Sets whether to make a beep sound when the One Push File Format function is turned on with Fx1 or Fx2 .	On
		Wi-Fi	Sets whether to make a beep sound when the Wi-Fi function is turned on or off with Fx1 or Fx2 .	On
Night Vision LCD Display		Sets whether to make a beep sound when the Night Vision LCD Display is turned on or off with Fx1 or Fx2 .	On	
Electronic Level	Sets whether to make a beep sound when the Electronic Level display is turned on or off with Fx1 or Fx2 .	On		

Menu	Item	Function	Default Setting	
2	LCD Display Settings	Sets the brightness, saturation, and color adjustment of the monitor.	0	
	Outdoor View Setting	Adjusts the brightness of the monitor for outdoor shooting.	Off	
	Night Vision LCD Display *1	Changes the monitor display color to red for shooting in a dark place such as night-time shooting.	Off	
	Indicator Lamps	Other Indicator Lamps	Sets the brightness of the main switch lamp when the camera is turned on.	High
		Self-timer	Sets whether to make the self-timer lamp blinking during the countdown for the drive mode [Self-timer (12 sec.)].	On
Remote Control		Sets whether to make the remote control receiver lamp blinking during the standby time for the drive mode [Remote Control].	On	
GPS LED Indicators		Sets whether to light up the GPS unit lamps when the GPS unit is attached.	On	
3	Wi-Fi *1	Activates the Wi-Fi function.	Off	
	GPS/E-Compass	GPS Time Sync	Automatically adjusts the date and time settings.	On
		Calibration	Performs a calibration of direction information.	–
	USB Connection	Sets the USB connection mode when connecting to a computer with a commercially available USB cable.	MSC	
	HDMI Out	Sets the output format when connecting to an AV device with an HDMI input terminal.	Auto	
	External Input Devices *1	Sets the external input device connected to the microphone/cable release terminal.	Auto Select	
	Auto Power Off	Sets the time until the camera turns off automatically if no operations are made for a certain period of time.	1min.	

Menu	Item	Function	Default Setting	
4	Create New Folder	Creates a new folder on the memory card.	–	
	Folder Name	Sets the folder name in which images are stored.	Date	
	File Name	Sets the file name assigned to an image.	IMGF, _IMG	
	File No.	Sequential Numbering	Continues the sequential numbering for the file name when a new folder is created.	On
		Reset File Number	Resets the file number setting and returns to 0001 each time a new folder is created.	–
	Copyright Information		Sets the photographer and copyright information embedded in the Exif data.	Off
	Format		Formats a memory card.	–
5	Pixel Mapping		Maps out and corrects defective pixels on the sensor.	–
	Dust Removal		Cleans the sensor by applying high-frequency (ultrasonic) vibrations.	Off, Off
	Sensor Cleaning		Locks the mirror in the up position for cleaning the sensor with a blower.	–
	Certification Marks		Displays the certification marks of conformance to wireless technical standards.	–
	Firmware Info/Options		Displays the camera's firmware version. You can check the current firmware version before running an update.	–
	Reset		Resets the settings of the direct keys and for the items of the  menus,  menus,  menu,  menus, control panel, and playback mode palette.	–

*1 Available as a function in the control panel.

Custom Setting Menus

Menu	Item	Function	Default Setting
C1	1 EV Steps	Sets the adjustment steps for the exposure.	1/3 EV Steps
	2 Sensitivity Steps	Sets the adjustment steps for the ISO sensitivity.	1 EV Step
	3 Meter Operating Time	Sets the meter operating time.	10sec.
	4 Auto EV Compensation	Automatically compensates the exposure when the correct exposure cannot be achieved with the current settings.	Off
	5 Link AE and AF Point	Sets whether to link the exposure value and the AF point in the focusing area.	Off
	6 AE-L with AF Locked	Sets whether to lock the exposure value when the focus is locked.	Off
	7 Bulb (B) Mode Options	Sets the camera operation when SHUTTER is pressed in B mode.	Type1
C2	8 Release While Charging	Sets whether to release the shutter while the built-in flash is being charged.	Off
	9 AF with Remote Control	Sets whether to use autofocus when shooting with a remote control unit.	Off
	10 Bracketing Order	Sets the order for Bracketing shooting.	0 - +
	11 One-Push Bracketing	Shoots all frames with one press of the release in Bracketing.	Off
	12 Interval Shooting Options	Sets whether to start counting the time of interval from when exposure starts or when exposure ends for Interval Shooting, Interval Composite, and Interval Movie Record.	Interval
	13 AF in Interval Shooting	Sets whether to lock the focus position used when the first picture is taken or perform autofocus for each exposure for Interval Shooting, Interval Composite, Interval Movie Record, and Star Stream.	Locks focus at 1st exposure
	14 WB Adjustable Range	Sets whether to automatically fine-tune the white balance when the light source is specified for the white balance setting.	Fixed

Menu	Item	Function	Default Setting
C3	15 AWB in Tungsten Light	Sets the tungsten light color tone when the white balance is set to [Auto White Balance].	Strong Correction
	16 WB When Using Flash	Sets the white balance setting when using a flash.	Auto White Balance
	17 Color Temperature Steps	Sets the adjustment steps for the Color Temperature option of the white balance.	Kelvin
	18 4-way Controller Settings	Selects the operation of the arrow keys (▲▼◀▶) when the focusing area selection mode is set to one of some select-type options.	Type1
	19 Auto SR Off	Automatically turns off the Shake Reduction function when the drive mode is set to [Self-timer] or [Remote Control].	Enable Auto SR Off
	20 Save Rotation Info	Saves rotation information when shooting.	On
C4	21 Save Menu Location	Saves the last menu tab displayed on the monitor and displays it again the next time MENU is pressed.	Reset Menu Location
	22 Catch-in Focus	Enables Catch-in Focus shooting when a manual focus lens is attached. The shutter is released automatically when the subject comes into focus.	Off
	23 AF Fine Adjustment	Allows you to precisely fine-tune your lenses with the camera's autofocus system.	Off
	24 Using Aperture Ring	Enables the shutter to release when the lens aperture ring is set to a position other than A (Auto).	Disable
	Reset Custom Functions	Resets the settings of the Custom Setting menus to the defaults.	–

Getting Your Camera Ready for Use

Attaching the Strap

- 1 Pass the end of the strap through the strap lug and secure it on the inside of the clasp.

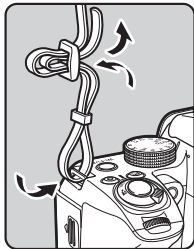

- 2 Attach the other end in the same manner.

Attaching a Lens

- 1 Make sure that the camera is turned off.
- 2 Remove the body mount cover (1) and lens mount cover (2).

After removing the cover, be sure to put the lens down with the lens mount side facing upward.

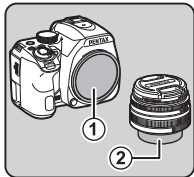

- 3 Align the lens mount indexes (red dots: 3) on the camera and the lens, and secure by turning the lens clockwise until it clicks.

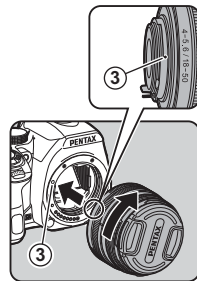

To remove the lens

Attach the lens cap, and then turn the lens counterclockwise while pressing the lens unlock button (4).

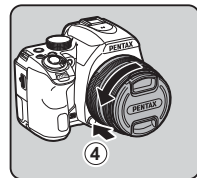

⚠ Caution

- When a retractable lens is attached and is not extended, you cannot take pictures or use some functions. If the lens is retracted during shooting, the camera stops working. Refer to Step 2 of "Shooting with the Viewfinder" (p.32) for details.

Charging the Battery

- 1 Connect the AC plug cord to the battery charger.
- 2 Plug the AC plug cord into the power outlet.

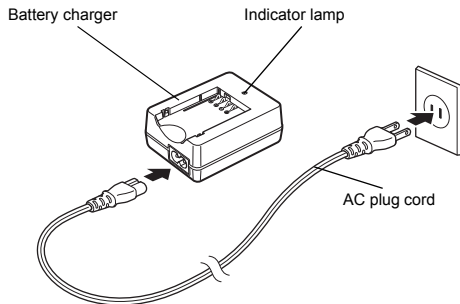

- 3 Face the ▲ mark on the battery up, and insert it into the battery charger.

Insert the battery into the battery charger at an angle, and then fit into place.

The indicator lamp lights while charging and turns off when the battery is fully charged.

(Approximate maximum charging time: 240 minutes)

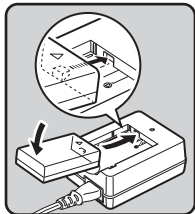

Inserting/Removing the Battery

- 1 Open the battery cover.
Slide the battery cover unlock lever (1) before opening the cover.

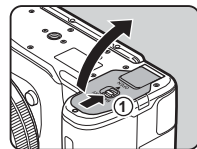

- 2 Face the ▲ mark on the battery towards the outside of the camera, and insert the battery until it locks into place.

To remove the battery, push the battery lock lever in the direction of 2.

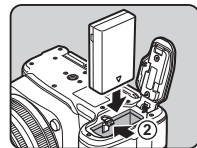

- 3 Close the battery cover.

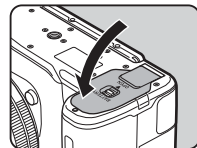

Inserting/Removing a Memory Card

1 Make sure that the camera is turned off.

2 Slide the memory card cover in the direction of ① and then rotate it to open as shown by ②.

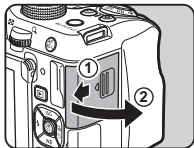

3 Insert a card all the way into the memory card slot with the memory card label facing toward the side with the monitor.

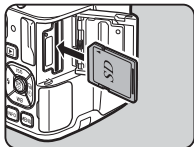

Push the memory card in once and release to remove.

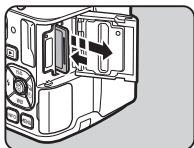

4 Rotate the memory card cover as shown by ③, and slide it in the direction of ④.

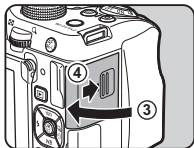

Opening the Monitor

1 Open and rotate the monitor 180° to the left while holding the top and bottom of it.

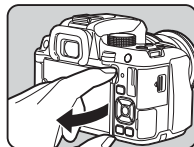

2 Rotate the monitor 180° backward.

The monitor can also be rotated up to 90° forward.

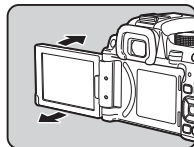

3 Close the monitor on the camera so that the LCD screen can be seen.

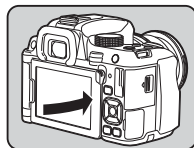

Setting the Display Language and Date/Time

- 1** Turn the main switch to [ON].

The lamp lights up in green.
The [Language/言語] screen appears.

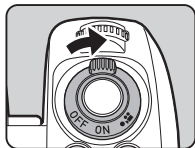

- 2** Use **▲▼◀▶** to select the desired language and press **OK**.

The [Initial Setting] screen appears in the selected language.

Proceed to Step 7 if **🏠** (Hometown) does not need to be changed.

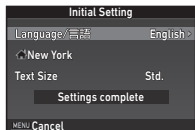

- 3** Press **▼** to move the frame to **🏠** and press **▶**.
The [**🏠** Hometown] screen appears.

- 4** Use **◀▶** to select a city.
Use **🌐** to change the region.

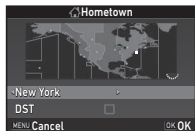

- 5** Press **▼** to select [DST] (daylight saving time), and use **◀▶** to select or .

- 6** Press **OK**.

The camera returns to the [Initial Setting] screen.

- 7** Press **▼** to select [Text Size] and press **▶**.

- 8** Use **▲▼** to select [Std.] or [Large], and press **OK**.

Selecting [Large] increases the text size of the selected menu items.

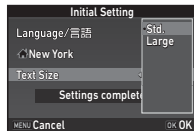

- 9** Press **▼** to select [Settings complete] and press **OK**.

The [Date Adjustment] screen appears.

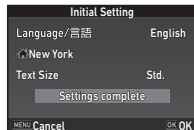

- 10** Press **▶**, and use **▲▼** to select the date format.

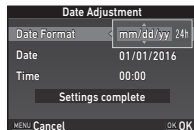

- 11** Press **▶**, and use **▲▼** to select [24h] or [12h].

- 12** Press **OK**.

The frame returns to [Date Format].

13 Press **▼**, and then press **▶**.

The frame moves to the month if the date format is set to [mm/dd/yy].

14 Use **▲▼** to set the month.

Set the day, year, and time in the same manner.

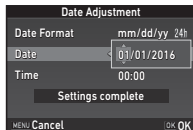

15 Press **▼** to select [Settings complete] and press **OK**.

The [LCD Display] screen appears.

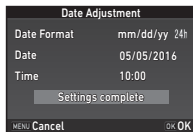

16 Use **◀▶** to select a color.

Select the display color of the status screen, control panel, and menu cursor from colors 1 to 12.

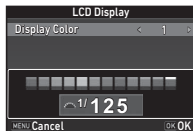

17 Press **OK**.

The camera switches to capture mode and is ready to take a picture.

Formatting a Memory Card



1 Press **MENU**.

The **1** menu appears.

2 Use or to display **4** menu.

3 Use **▲▼** to select [Format] and press **▶**.

The [Format] screen appears.

4 Press **▲** to select [Format] and press **OK**.

Formatting starts. When formatting is completed, the **4** menu reappears.

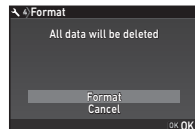

5 Press **MENU**.

The camera switches to capture mode and is ready to take a picture.

Basic Shooting Operation

Shooting with the Viewfinder

- 1** Remove the front lens cap by pushing the top and bottom portions as indicated in the illustration.

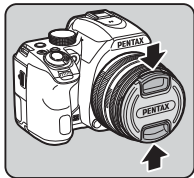

- 2** When a retractable lens is attached, turn the zoom ring in the direction of ② while pressing the button on the ring (①).

When retracting the lens, turn the zoom ring in the opposite direction to ② while pressing the button on the ring and align the white dot to the position ③.

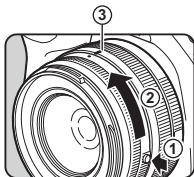

- 3** Set the focus mode switch to AF.

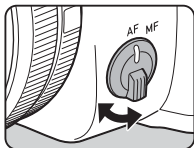

- 4** Turn the mode dial and align the dial indicator to AUTO.

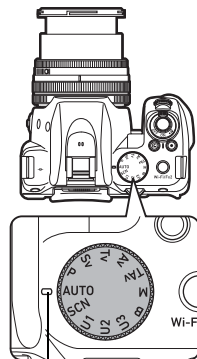

Dial indicator

The selected capture mode is displayed on the monitor (Guide Display).

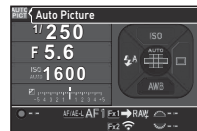

- 5** Look through the viewfinder to view the subject.

When using a zoom lens, turn the zoom ring to the right or left to change the angle of view.

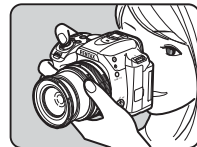

- 6** Position the subject inside the AF frame and press **SHUTTER** halfway.

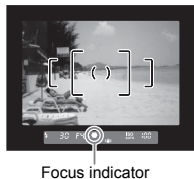

- 7** Press **SHUTTER** fully.

The captured image is displayed on the monitor (Instant Review).

Available operations during Instant Review



Deletes the image.



to the right Magnifies the image.



Saves the RAW data (only when a JPEG image was taken and the data remains in the buffer).

Shooting while Viewing the Live View Image

- 1** Press **LV** in Step 5 of “Shooting with the Viewfinder” (p.32).

The Live View image is displayed on the monitor.

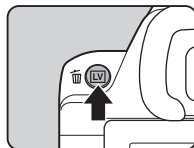

- 2** Position the subject inside the AF frame on the monitor and press **SHUTTER** halfway.







AF frame

Available operations



Magnifies the image.

Use  to change the magnification (up to 16×).

Use     to change the area to display.

Press  to return the display area to the center.









Press **OK** to return to 1× image display.



Exits shooting with Live View.

Subsequent steps are the same as shooting with the viewfinder.

Capture Modes for Still Pictures

Capture Mode	Function	Page
AUTO (Auto Picture modes)	Automatically selects the optimal capture mode from  (Standard),  (Portrait),  (Landscape),  (Macro),  (Moving Object),  (Night Scene Portrait),  (Sunset),  (Blue Sky), or  (Forest).	p.32
SCN (Scene modes)	Offers you various scene modes to choose from.	p.34
P, Sv, Tv, Av, TAv, M, B (Exposure modes)	Allows you to change the shutter speed, aperture value, and sensitivity.	p.35
U1 (CLEAR TONE)	Creates a clear and bright atmosphere in pictures.	-
U2 (HDR LANDSCAPE)	Gives a bold and dramatic look to landscape shots.	
U3 (ASTROPHOTO)	Adjusts the background black level and reproduces the colors of stars faithfully.	

Memo

- The functions that can be set vary depending on the capture mode. Refer to “Restrictions on Each Capture Mode” (p.45) for details.
- You can save frequently used exposure modes and capture settings as USER modes to **U1** to **U3** and replace the preset settings with them.









Scene Modes











1 Set the mode dial to SCN.

The scene mode selection screen appears.

2 Select a scene mode.



 Portrait	For capturing portraits. Reproduces a healthy and bright skin tone.
 Landscape	For capturing landscape views. Reproduces the vivid green of trees.
 Macro	For capturing tiny objects at close focus range like flowers, coins, jewelry, and more.
 Moving Object	For capturing images of fast moving subjects.
 Night Scene Portrait	For capturing images of people in low light conditions, such as dusk or at night.
 Sunset	For capturing sunrises or sunsets in beautiful, vivid color.
 Blue Sky	For capturing images of blue sky. Produces a more impressive deep blue.
 Forest	Enhances colors of trees and sunbeams through foliage and produces a vivid color image.

 Night Scene	Used for shooting at night.
 Night Scene HDR	Takes three consecutive images at three different exposure levels (-1, ±0, +1) to create a single composite image from them.
 Night Snap	For taking snapshots in poorly lit places.
 Food	For capturing images of food. Saturation will be rather high to make food look appetizing.
 Pet	For capturing moving pets.
 Kids	For capturing moving kids. Reproduces healthy and bright skin tone.
 Surf & Snow	For capturing images of dazzling backgrounds, such as snowy mountains.
 Backlight Silhouette	Produces a silhouette image of the subject in backlight conditions.
 Candlelight	For capturing scenes in candlelight.
 Stage Lighting	For capturing moving subjects in poorly lit places.
 Museum	For capturing images in places where a flash is prohibited.

3 Press **OK**.

The camera is in standby mode.

Turn  to change the scene mode.

Exposure Modes

✓: Available #: Restricted ✗: Not available

Mode	Change Shutter Speed	Change Aperture Value	Change Sensitivity	EV Compensation
P Program Automatic Exposure	# *1	# *1	✓	✓
Sv Sensitivity Priority Automatic Exposure	✗	✗	✓ *2	✓
Tv Shutter Priority Automatic Exposure	✓	✗	✓	✓
Av Aperture Priority Automatic Exposure	✗	✓	✓	✓
TAv Shutter & Aperture Priority Automatic Exposure	✓	✓	✗ *3	✓
M Manual Exposure	✓	✓	✓ *2	✓
B Bulb Exposure	✗ *4	✓	✓ *2	✗

*1 You can set the value to change in [E-Dial Programming] of [Button Customization] in the 5 menu.

*2 [ISO AUTO] is not available.

*3 Fixed to [ISO AUTO].

*4 When the timed exposure is enabled, shutter speeds ranging from 10 seconds to 20 minutes can be set.

1 Set the mode dial to the desired exposure mode.

or appears on the status screen for the value that can be changed.



The value that can be changed is underlined in the viewfinder.



During Live View, appears for the value that can be changed.



2 Turn .

The aperture value is changed in **Av**, **TAv**, **M**, or **B** mode. The sensitivity is changed in **Sv** mode.

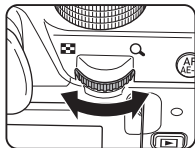

3 Turn .

The shutter speed is changed in **Tv**, **TAv**, or **M** mode.

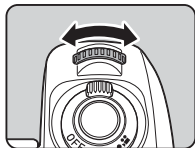

Bulb Exposure

1 Set the mode dial to **B**.

2 Use to set the aperture value.



3 To enable the timed exposure, press , and then use to set the exposure time.

You can set the exposure time within the range from 10" to 20'00".

4 Press **SHUTTER**.

While **SHUTTER** is pressed, exposure continues.

If the timed exposure is enabled in Step 3, the exposure ends when the set exposure time elapses after **SHUTTER** is fully pressed.

Setting the Sensitivity

1 Press **▲** in standby mode.

2 Use **▲▼** to select an item.

ISO AUTO	Sets the range to be adjusted automatically. Both the upper limit and lower limit can be changed.
ISO	Sets a fixed value from ISO 100 to ISO 102400.

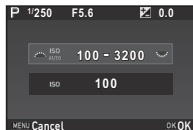

3 Use  or  to change the value.

4 Press **OK**.

The camera returns to standby mode.

Compensating the Exposure

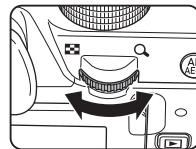
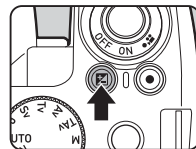

1 Press , and then turn .

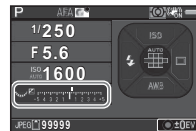

 and the compensation value are displayed on the status screen, Live View screen, and in the viewfinder during adjustment.



Available operations

-  Starts/ends adjusting the compensation value.
-  Resets the adjustment value to the default setting.

Recording Movies

- 1 Turn the main switch to .

The indicator lamp lights red and the Live View image is displayed.

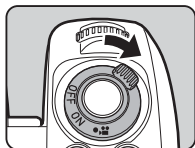

Recordable Time

- 2 Set the mode dial to the desired capture mode.

The following settings are available depending on the capture mode.

P, Av, TAv, M	The camera operates in the selected exposure mode. (The aperture value can be changed only before shooting. When set to M mode, the sensitivity can also be changed.)
U1 to U3	The camera operates according to the saved exposure mode.
Other modes	The camera operates in P mode.

- 3 Focus on the subject.

In **AF** mode, press **SHUTTER** halfway.

- 4 Press **SHUTTER** fully.

Movie recording starts.

In the upper left area of the monitor, "REC" blinks.

- 5 Press **SHUTTER** fully again.

Movie recording stops.

- 6 Return the main switch to the [ON] position to exit  mode.

The camera returns to shooting with the viewfinder in  mode.

Focus Motor Noise during Movie Recording

When [AF Mode] of [AF with Live View] in the 1 menu is set to **AF.C**, focus motor drive noise is recorded.

Adjusting the sound level in [Recording Sound Level] of the 1 menu, or using an external microphone can reduce the motor noise to be recorded.

Using the Built-in Flash

1 Press **◀** in standby mode.

2 Select a flash mode.

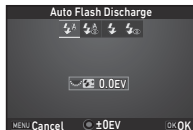

	Auto Flash Discharge	Automatically measures the ambient light and determines whether to use the flash.
	Auto Flash + Red-eye	Discharges a pre-flash for red-eye reduction before an automatic flash.
	Flash On	Discharges a flash for each picture.
	Flash On + Red-eye	Discharges a pre-flash for red-eye reduction before the main flash for each picture.
	Slow-speed Sync	Sets to a slow shutter speed and discharges a flash for each picture. Use this, for example, when shooting a portrait with the sunset in the background.
	Slow Sync + Red-eye	Discharges a pre-flash for red-eye reduction before the main flash is discharged with Slow-speed Sync.

	Trailing Curtain Sync	Discharges a flash immediately before closing the shutter. Sets to a slow shutter speed. Captures moving objects as if they are leaving a light trail behind them.
	Manual Flash Discharge	Sets the amount of flash discharge between FULL and 1/128 power.

Available operations



Compensates the flash exposure.
Selects the amount of flash discharge (when [Manual Flash Discharge] is selected).



Resets the compensation value to the default setting.

3 Press **OK**.

The camera returns to standby mode.

4 Press .

The built-in flash is popped up.

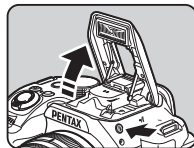

Memo

- The flash modes that can be selected vary depending on the capture mode.

Setting the Drive Mode

1 Press **▶** in standby mode.

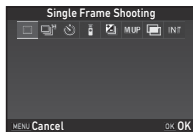

2 Select a drive mode.

Single Frame Shooting (□)	Normal capture mode
Continuous Shooting (□ ^M , □ ^L)	Continuously takes pictures while SHUTTER is kept pressed.
Self-timer (☺, ☺, ☺)	Releases the shutter about 12 seconds or 2 seconds after SHUTTER is pressed.
Remote Control (⏏, ⏏ ^{AS} , ⏏ ^Q)	Enables shooting with remote control.
Bracketing ([A], [B], [C])	Takes consecutive pictures at different exposure levels.
Mirror Lock-up Shooting (MUP, MUP)	Takes pictures with the mirror raised.
Multi-exposure ([M], [M], [M], [M])	Creates a composite image by taking multiple pictures and merging them into a single image.
Interval Shooting (INT, [INT], [INT], [INT])	Automatically takes pictures at set intervals.

3 Press **INFO** to change detailed settings, and press **OK**.

4 Press **OK**.

The camera returns to standby mode.

⚠ Caution

- There are restrictions on some drive modes when used in some capture modes or in combination with some other functions. (p.45)

📌 Memo

- In **📷** mode, you can select only [Remote Control Off] or [Remote Control].

Setting the White Balance

1 Press **▼** in standby mode.

2 Select the desired white balance setting.

For **☀**, **☂**, and **K**, turn **☺** to select the type of white balance.

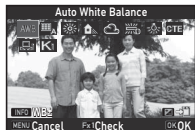

AWB	Auto White Balance
A	Multi Auto White Balance
☀	Daylight
☂	Shade
☺	Cloudy
☺	Fluorescent - Daylight Color
☺	Fluorescent - Daylight White
☺	Fluorescent - Cool White
☺	Fluorescent - Warm White
☺	Tungsten
CTE	Color Temperature Enhancement
☺	Manual White Balance 1 to 3
K	Color Temperature 1 to 3

3 Press **OK**.

The camera returns to standby mode.

Reviewing Images

1 Press **▶**.

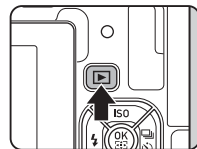











The camera enters playback mode and the most recently captured image is displayed (single image display).



2 Review the captured image.

Available operations









 to the left	Displays the previous image.
 to the right	Displays the next image.
	Deletes the image.
 to the right	Magnifies the image (up to 16×). Use   to change the area to display. Press  to return the display area to the center. Press OK to return to the entire image display.
 to the left	Switches to the thumbnail display.
	Saves the RAW data (only when a JPEG image was taken and the data remains in the buffer).
INFO	Changes the type of information displayed (p.10).
	Displays the playback mode palette (p.43).

Playing Back Movies

- 1 Display the movie to play back in single image display of the playback mode.



Available operations









	Plays back/pauses a movie.
	Forwards a frame (when paused).
Press and hold 	Fast-forwards playback.
	Reverses a frame (when paused).
Press and hold 	Fast-reverses playback.
	Stops playback.
	Adjusts the sound volume (21 levels).
	Saves the displayed frame as a JPEG file (when paused).
INFO	Switches between [Standard Information Display] and [No Information Display].



Playback Mode Palette

Playback functions can be set from the playback mode palette as well as the 1 menu.

Press  in single image display (Standard Information Display or No Information Display) of the playback mode palette to display the playback mode palette.



Item	Function
 Image Rotation *1	Changes the rotation information of images.
 Digital Filter *1	Processes images with digital filters.
 Color Moiré Correction *1 *2	Reduces color moiré in images.
 Resize *1 *2	Changes the number of recorded pixels of the image.
 Cropping *1	Crops out only the desired area of an image.
 Protect	Protects images from being accidentally erased.
 Slideshow	Plays back images one after another.
 Save as Manual WB *1	Saves the white balance settings of the captured image as Manual White Balance.
 Save Cross Processing	Saves the settings used for an image captured in Cross Processing mode of Custom Image as your "Favorite" settings.

Item	Function
 RAW Development *3	Develops RAW images into JPEG images and saves them as new files.
 Movie Edit *4	Divides a movie or deletes unwanted segments.

*1 Not available when a movie is displayed.

*2 Not available when a RAW image is displayed.

*3 Available only if a RAW image has been saved.

*4 Available only when a movie is displayed.

Sharing Images

Enabling the Wi-Fi Function

The Wi-Fi function is disabled when the camera is turned on. Enable the function using one of the following methods.

Setting from the Menus



1 Select [Wi-Fi] in menu and press .

2 Set [Action Mode] to [On].



3 Press **MENU** twice.

Using the **Fx2** Button

1 Press and hold **Fx2** in single image display of the playback mode.

Press and hold **Fx2** again to disable the Wi-Fi function.

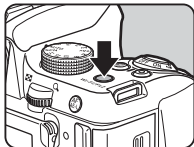

Caution

- By default, you can turn the Wi-Fi function on and off by pressing and holding **Fx2**. If the **Fx2** button function is changed in [Button Customization] of the 5 menu, you cannot turn the Wi-Fi function on and off with **Fx2**.

Operating the Camera with a Communication Device

The following functions can be used by connecting the camera to a communication device via Wi-Fi and using the dedicated application "Image Sync".











Remote Capture	Displays the Live View image of the camera on the communication device, and enables controlling exposure settings and shooting by operating the communication device.
Image View	Displays the images saved on the memory card inserted in the camera on the communication device and imports the images to the communication device.

Image Sync supports iOS and Android, and can be downloaded from the App Store or Google Play. For supported OS and other details, refer to the download site.

Restrictions on Each Capture Mode

#: Restricted X: Not available

Capture Mode	AUTO	SCN									B	
Sensitivity							X	X		X	*1	
Flash						X	X			X		X
Drive Mode	Continuous Shooting						X				X	X
	Self-timer			X					X			X
	Remote Control			X					X			
	Bracketing			X			X		X		X	X
	Multi-exposure			X			X		X			X
	Interval Shooting			X					X		X	X
	Interval Composite			X			X		X		X	X
	Interval Movie Record			X					X		X	X
	Star Stream			X			X		X		X	X
AF with Viewfinder	A.F.A. ^{*2}	A.F.S. ^{*2}	A.F.S. ^{*2}	A.F.C. ^{*2}	A.F.S. ^{*2}	A.F.S. ^{*2}	A.F.S. ^{*2}	A.F.C. ^{*2}	A.F.C. ^{*2}	A.F.C. ^{*2}		

Function	Capture Mode	SCN									B		
		AUTO											
File Format RAW/RAW+													X
White Balance	AWB ^{*2}	AWB ^{*2}	AWB ^{*2}	AWB ^{*2}	AWB ^{*2}	AWB ^{*2}	AWB ^{*2}	AWB ^{*2}	AWB ^{*2}	AWB ^{*2}	AWB ^{*2}		
Custom Image	X ^{*4}	X ^{*4}	X ^{*4}	X ^{*4}	X ^{*4}	X ^{*4}	X ^{*4}	X ^{*4}	X ^{*4}	X ^{*4}	X ^{*4}		
Clarity/Skin Tone							X						
Digital Filter							X						
HDR Capture				X			X ^{*5}		X			X	X
Pixel Shift Resolution				X			X		X			X	X
AA Filter Simulator				# ^{*6}			X		# ^{*6}			# ^{*6}	X
Shake Reduction							On ^{*2}					X	
Save RAW Data				X					X				X

*1 [ISO AUTO] is not available.

*2 Fixed to; the setting cannot be changed.

*3 Limited to; available settings are limited.

*4 Fixed to; specific settings to the selected mode are used.

*5 Fixed to [HDR AUTO].

*6 [Bracketing] is not available.

Restrictions on the Combinations of Special Functions

#: Restricted x: Not available

	Clarity/ Skin Tone/ Digital Filter	HDR Capture	Pixel Shift Resolution	ASTRO- TRACER	AA Filter Simulator	Distortion Correction/ Diffraction Correction	Save RAW Data
Flash		x	x				
Drive Mode	Continuous Shooting		x	x	# ^{*2}		x
	Bracketing		x	x	# ^{*2}		
	Mirror Lock-up Shooting		x		# ^{*2}		
	Multi-exposure	x	x	x	# ^{*2}	x	
	Interval Shooting	# ^{*1}	# ^{*1}	x	x	# ^{*2}	# ^{*3}
	Interval Composite	x	x	x	x	# ^{*2}	x
	Interval Movie Record	# ^{*1}	# ^{*1}	x	x	# ^{*2}	x
	Star Stream	x	x	x	x	# ^{*2}	x
HDR Capture	x		x	x	x		
Pixel Shift Resolution	x	x		x	x		
AA Filter Simulator		x	x	# ^{*2}			

*1 There is a restriction on the minimum value for [Interval].

*2 [Bracketing] is not available.

*3 Only the final frame can be saved.

Functions Available with Various Lenses

All capture modes are available when a DA, DA L, D FA, FA J, or FA lens is used, or when a lens with an **A** position is used with the aperture ring set to the **A** position.

Depending on the lens to use, the following restrictions apply.

✓: Available #: Restricted ✗: Not available

Function	Lens [Mount type]					
	DA DA L D FA	FA J FA *6	F *6	A	M P	
	[KAF] [KAF2] [KAF3] [KAF4]	[KAF] [KAF2]	[KAF]	[KA]	[K]	
Autofocus (Lens only) (With AF adapter 1.7x) ^{*1}	✓ –	✓ –	✓ –	– #	– #	
Manual focus (With focus indicator) ^{*2} (With matte field)	✓	✓	✓	✓	✓	
Quick-shift focus	# ^{*4}	✗	✗	✗	✗	
AF Active Area [Auto]	✓	✓	✓	# ^{*8}	✗	
AE Metering [Multi-segment]	✓	✓	✓	✓	✗	
P/Sv/Tv/Av/TA v mode	✓	✓	✓	✓	# ^{*9}	
M mode	✓	✓	✓	✓	#	
P-TTL auto flash ^{*3}	✓	✓	✓	✓	✗	
Automatic obtaining of the lens focal length information	✓	✓	✓	✗	✗	
Lens Correction	✓ ^{*5}	# ^{*7}	✗	✗	✗	

- *1 Lenses with a maximum aperture of F2.8 or faster. Only available at the **A** position.
- *2 Lenses with a maximum aperture of F5.6 or faster.
- *3 Available when using the built-in flash, AF540FGZ, AF540FGZ II, AF360FGZ, AF360FGZ II, AF201FG, AF200FG, or AF160FC.
- *4 Only available with compatible lenses.
- *5 Distortion Correction and Peripheral Illumination Correction are disabled when a DA FISH-EYE 10-17mm lens is used.
- *6 To use an FA SOFT 28mm F2.8 lens, FA SOFT 85mm F2.8 lens, or F SOFT 85mm F2.8 lens, set [24 Using Aperture Ring] to [Enable] in the **C4** menu. Pictures can be taken with the aperture you set, but only within a manually adjustable aperture range.
- *7 The Lens Correction features are available with the following FA lenses (Only Distortion Correction and Lateral Chromatic Aberration Adjustment can be used when the aperture ring is set to a position other than **A**.): FA^{*}24mm F2 AL [IF], FA 28mm F2.8 AL, FA 31mm F1.8 Limited, FA 35mm F2 AL, FA 43mm F1.9 Limited, FA 50mm F1.4, FA 77mm F1.8 Limited, FA^{*}85mm F1.4 [IF], FA^{*}200mm F2.8 ED [IF], FA^{*}MACRO 200mm F4 ED, FA^{*}300mm F2.8 ED [IF], FA^{*}300mm F4.5 ED [IF], FA^{*}400mm F5.6 ED [IF], FA^{*}600mm F4 ED [IF], FA^{*}28-70mm F2.8 ED [IF], FA^{*}80-200mm F2.8 ED [IF], and FA^{*}250-600mm F5.6 ED [IF].
- *8 Fixed to [Spot].
- *9 **Av** with the aperture set to wide open. (The aperture ring has no effect on the actual aperture value.)

Main Specifications

Model Description

Type	TTL autofocus, auto-exposure SLR digital camera with a built-in retractable P-TTL flash
Lens Mount	PENTAX KAF2 bayonet mount (AF coupler, lens information contacts, K-mount with power contacts)
Usable Lenses	KAF4, KAF3, KAF2 (power zoom not compatible), KAF, KA mount lenses

Image Capture Unit

Image Sensor	CMOS with a primary color filter, Size: 23.5 × 15.6 (mm)
Effective Pixels	Approx. 24.24 megapixels
Total Pixels	Approx. 24.78 megapixels
Dust Removal	Image sensor movement combined with SP coating
Sensitivity (Standard Output)	ISO AUTO, Manual ISO range: 100 to 102400 • EV steps can be set to 1 EV, 1/2 EV, or 1/3 EV
Image Stabilizer	Sensor-shift Shake Reduction (SR)
AA Filter Simulator	Moiré reduction using SR unit: Off, Type1, Type2, Bracketing (3 images)

File Formats

Recording Formats	RAW (PEF/DNG), JPEG (Exif 2.3 compliant), DCF 2.0 compliant
Recorded Pixels	JPEG: [L] (24M: 6000×4000), [M] (14M: 4608×3072), [S] (6M: 3072×2048), [XS] (2M: 1920×1280) RAW: [L] (24M: 6000×4000)
Quality Level	RAW (14bit): PEF, DNG JPEG: ★★★ (Best), ★★ (Better), ★ (Good) • RAW + JPEG simultaneously recordable
Color Space	sRGB, AdobeRGB
Storage Media	SD/SDHC*/SDXC* memory card * UHS-I compatible

Storage Folder	Folder Name: Date (100_1018, 101_1019...) or user-assigned name (default: PENTX)
Storage File	File Name: user-assigned name (default: IMGPF****) File No.: Sequential Numbering, Reset

Viewfinder

Type	Pentaprism Finder
Coverage (FOV)	Approx. 100%
Magnification	Approx. 0.95× (50mm F1.4 at infinity)
Eye-Relief Length	Approx. 20.5 mm (from the view window) Approx. 22.3 mm (from the center of lens)
Diopter Adjustment	Approx. -2.5 to +1.5 m ⁻¹
Focusing Screen	Interchangeable Natural-Bright-Matte III focusing screen

Live View

Type	TTL method using the CMOS image sensor
Autofocusing System	Hybrid AF of image plane phase-matching and contrast detection AF Active Area: Face Detection, Tracking, Multiple AF Points, Select, Spot Focus Peaking: On, Off
Display	Field of view: approx. 100%, Magnified view (up to 16×), Grid Display (4×4 Grid, Golden Section, Scale, Square 1, Square 2, Grid Color: Black, White), Histogram, Highlight Alert

LCD Monitor

Type	Vari-angle TFT color LCD monitor featuring an air-gapless structure with a tempered-glass front panel
Size	3.0 inches (aspect ratio 3:2)
Dots	Approx. 921K dots
Adjustment	Brightness, saturation and colors adjustable

Outdoor View Setting	±2 steps
Night Vision LCD Display	On, Off

White Balance

Type	TTL method using the CMOS image sensor
Preset Modes	Auto White Balance, Multi Auto White Balance, Daylight, Shade, Cloudy, Fluorescent Light (D: Daylight Color, N: Daylight White, W: Cool White, L: Warm White), Tungsten Light, CTE , Manual White Balance (up to 3 settings), Color Temperature (up to 3 settings), Copying the white balance settings of a captured image
Fine Adjustment	Adjustable ±7 steps on A-B axis and G-M axis

Focus System

Type	TTL phase-matching autofocus system
Focus Sensor	SAFOX X, 11 points (9 cross type focus points in the center)
Brightness Range	EV -3 to 18 (ISO100, at normal temperature)
AF Modes	Single AF (A.F.S.), Continuous AF (A.F.C.), Auto select AF (A.F.A.)
Focusing Area Selection Modes	Auto (11 AF Points), Auto (5 AF Points), Select, Expanded Area AF, Spot
AF Assist Light	Dedicated LED AF assist light

Exposure Control

Type	TTL open-aperture 77 segment metering Metering modes: Multi-segment, Center-weighted, Spot
Metering Range	EV 0 to 22 (ISO100 at 50mm F1.4)

Capture Modes	Auto Picture (AUTO) modes: Standard, Portrait, Landscape, Macro, Moving Object, Night Scene Portrait, Sunset, Blue Sky, Forest Scene (SCN) modes: Portrait, Landscape, Macro, Moving Object, Night Scene Portrait, Sunset, Blue Sky, Forest, Night Scene, Night Scene HDR, Night Snap, Food, Pet, Kids, Surf & Snow, Backlight Silhouette, Candlelight, Stage Lighting, Museum Exposure modes: Program, Sensitivity Priority, Shutter Priority, Aperture Priority, Shutter & Aperture Priority, Manual, Bulb
EV Compensation	±5 EV (1/3 EV steps or 1/2 EV steps can be selected)
AE Lock	Can be assigned to AF/AE-L in [Button Customization].

Shutter

Type	Electronically controlled vertical-run focal plane shutter • Electronic shutter is used for Pixel Shift Resolution
Shutter Speed	Auto: 1/6000 to 30 seconds, Manual: 1/6000 to 30 seconds (1/3 EV steps or 1/2 EV steps), Bulb (timed exposure setting possible from 10 seconds to 20 minutes)

Drive Modes

Mode Selection	[Still picture] Single frame, Continuous (H, L), Self-timer (12 sec., 2 sec., continuous), Remote Control (immediately, 3 sec., continuous), Bracketing ^{*1} (2, 3, or 5 frames), Mirror Lock-up Shooting ^{*2} , Multi-exposure ^{*3} , Interval Shooting ^{*1} , Interval Composite ^{*1} , Interval Movie Record ^{*1} , Star Stream ^{*1} [Movie] Remote Control ^{*1} Available with Self-timer or Remote Control ^{*2} Available with Remote Control ^{*3} Available with Continuous Shooting, Self-timer, or Remote Control
----------------	---

Continuous Shooting	Max. approx. 6.0 fps, JPEG (L): ★★★ at Continuous H); up to approx. 40 frames, RAW: up to approx. 10 frames, RAW+: up to approx. 8 frames Max. approx. 3.0 fps, JPEG (L): ★★★ at Continuous L); up to approx. 100 frames, RAW: up to approx. 16 frames, RAW+: up to approx. 11 frames • When the sensitivity is set to ISO100
Multi-exposure	Composite Mode: Additive, Average, Bright Number of Shots: 2 to 2000 times
Interval Shooting	[Interval Shooting] Interval: 2 sec. to 24 hr., Standby Interval: minimum time or 1 sec. to 24 hr., Number of Shots: 2 to 2000 times, Start Interval: Now, Self-timer, Remote Control, Set Time [Interval Composite] Interval: 2 sec. to 24 hr., Standby Interval: minimum time or 1 sec. to 24 hr., Number of Shots: 2 to 2000 times, Start Interval: Now, Self-timer, Remote Control, Set Time, Composite Mode: Additive, Average, Bright, Save Process: On, Off [Interval Movie Record] Recorded Pixels: [4K], [FHD], [HD], Recording Format: Motion JPEG (AVI), Interval: 2 sec. to 24 hr., Standby Interval: minimum time or 1 sec. to 24 hr., Number of Shots: 8 to 2000 times (When [4K] is selected: 8 to 500 times), Start Interval: Now, Self-timer, Remote Control, Set Time [Star Stream] Recorded Pixels: [4K], [FHD], [HD], Recording Format: Motion JPEG (AVI), Standby Interval: minimum time or 1 sec. to 24 hr., Number of Shots: 8 to 2000 times (When [4K] is selected: 8 to 500 times), Start Interval: Now, Self-timer, Remote Control, Set Time, Fade-out: Off, Low, Medium, High

Flash



Built-in Flash	Built-in retractable P-TTL pop-up flash Guide number: approx. 12 (ISO100/m) Angle of view coverage: equivalent to 28mm lens in 35 mm format
----------------	---

Flash Modes	Auto Flash Discharge (Auto Picture, Scene Mode), Auto Flash + Red-eye Reduction (Auto Picture, Scene Mode), Flash On, Flash On + Red-eye Reduction, Slow-speed Sync, Slow-speed Sync + Red-eye Reduction, Trailing Curtain Sync, Manual Flash Discharge (FULL to 1/128 power)
Sync Speed	1/180 seconds
Flash Exposure Compensation	-2.0 to +1.0 EV
External Flash	P-TTL, Leading Curtain Sync, Trailing Curtain Sync, Contrast Control Sync*, High-speed Sync, Wireless Sync* * Available with two or more dedicated external flash units

Capture Functions

Custom Image	Auto Select, Bright, Natural, Portrait, Landscape, Vibrant, Radiant, Muted, Flat, Bleach Bypass, Reversal Film, Monochrome, Cross Processing
Cross Processing	Random, Preset 1-3, Favorite 1-3
Digital Filter	Extract Color, Replace Color, Toy Camera, Retro, High Contrast, Shading, Invert Color, Unicolor Bold, Bold Monochrome
Clarity	-4.0 to +4.0
Skin Tone	Type1, Type2, Off
HDR Capture	Auto, Type1, Type2, Type3, Advanced HDR, Off Bracket Value: adjustable Auto Align (automatic composition correction function): available
Pixel Shift Resolution	Motion Correction On, Motion Correction Off, Off
Lens Correction	Distortion Correction, Peripheral Illumination Correction, Lateral Chromatic Aberration Adjustment, Diffraction Correction
D-Range Settings	Highlight Correction, Shadow Correction
Noise Reduction	Slow Shutter Speed NR, High-ISO NR
Horizon Correction	SR On: corrects up to 1 degree SR Off: corrects up to 1.5 degrees
Electronic Level	Displayed in viewfinder (horizontal direction only); displayed on monitor (horizontal direction and vertical direction)

Movie

Recording Format	MPEG-4 AVC/H.264 (MOV)
Recorded Pixels	 (1920×1080, 60i/50i/30p/25p/24p)  (1280×720, 60p/50p)
Autofocusing System	Hybrid AF of image plane phase-matching and contrast detection AF Mode: Single AF (AF.S), Continuous AF (AF.C)* * Continuous AF (AF.C) is available only when a compatible lens is attached to the camera. AF Active Area: Multiple AF Points, Select, Spot Focus Peaking: On, Off
Sound	Built-in stereo microphone, external microphone (stereo recording compatible) Recording Sound Level: adjustable
Recording Time	Up to 4 GB or 25 minutes; automatically stops recording if the internal temperature of the camera becomes high.
Custom Image	Auto Select, Bright, Natural, Portrait, Landscape, Vibrant, Radiant, Muted, Flat, Bleach Bypass, Reversal Film, Monochrome, Cross Processing
Cross Processing	Random, Preset 1-3, Favorite 1-3
Digital Filter	Extract Color, Replace Color, Toy Camera, Retro, High Contrast, Shading, Invert Color, Unicolor Bold, Bold Monochrome

Playback Functions

Playback View	Single image, Multi-image display (6, 12, 20, 35, and 80 thumbnails), Image magnification (Up to 16× and quick zoom), Grid Display (4×4 Grid, Golden Section, Scale, Square 1, Square 2, Grid Color: Black, White), Rotated image display, Histogram (Y histogram, RGB histogram), Highlight Alert, Auto Image Rotation, Detailed Information Display, Copyright Information (Photographer, Copyright Holder), GPS information (Latitude, Longitude, Altitude, Coordinated Universal Time (UTC)), Direction, Folder Display, Calendar Filmstrip Display, Slideshow
Delete	Single image, all images, select & delete, folder, Instant Review image

Digital Filter	Base Parameter Adj, Extract Color, Replace Color, Toy Camera, Retro, High Contrast, Shading, Invert Color, Unicolor Bold, Bold Monochrome, Tone Expansion, Sketch, Water Color, Pastel, Posterization, Miniature, Soft, Starburst, Fish-eye, Slim, Monochrome
RAW Development	Development options: Select single image, Select multiple images, Select a folder Development parameters: White Balance, Custom Image, Sensitivity, Clarity, Skin Tone, Digital Filter, HDR Capture, Pixel Shift Resolution, Shadow Correction, High-ISO NR, Distortion Correction, Peripheral Illumination Correction, Lateral Chromatic Aberration Adjustment, Diffraction Correction, Color Fringe Correction, Aspect Ratio, JPEG Recorded Pixels, JPEG Quality, Color Space
Editing Features	Image Rotation, Color Moiré Correction, Resize, Cropping (aspect ratio can be changed and tilt correction is available), Movie Edit (dividing a movie file and deleting unwanted segments), Capturing a JPEG still picture from a movie, Save RAW Data

Customization

USER Modes	Up to 3 settings can be saved.
Custom Functions	24 items
Mode Memory	16 items
Button Customization	Fx1/Fx2 button: One Push File Format, Wi-Fi, Outdoor View Setting, Night Vision LCD Display, Preview, Electronic Level, Change AF Area AF/AE-L button: Enable AF1, Enable AF2, Cancel AF, AE Lock E-dials (front/rear): customizable to each exposure mode

AF Customization	AF.S: Focus-priority, Release-priority 1st Frame Action in AF.C: Auto, Focus-priority, Release-priority Action in AF.C Continuous: Auto, Focus-priority, FPS-priority Hold AF Status: Off, Low, Medium, High AF in Interval Shooting: Locks focus at 1st exposure, Adjusts focus for each shot AF with Remote Control: Off, On
Text Size	Standard, Large
World Time	World Time settings for 75 cities (28 time zones)
AF Fine Adjustment	±10 steps, adjustment for all lenses or individual lenses (up to 20 values can be saved)
Indicator Lamps	Other Indicator Lamps: High, Low, Off Self-timer: On, Off Remote Control: On, Off GPS LED Indicators: On, Off
Copyright Information	Names of "Photographer" and "Copyright Holder" are embedded to the image file. A revision history can be checked using the provided software.

Power Supply

Battery Type	Rechargeable Lithium-ion Battery D-LI109
AC Adapter	AC Adapter Kit K-AC168 (optional)
Battery Life	Number of recordable images: (with 50% flash usage): approx. 410 images (without flash usage): approx. 480 images Playback time: approx. 270 minutes <ul style="list-style-type: none"> Tested in compliance with CIPA standard using a fully charged lithium-ion battery at a temperature of 23°C. Actual results may vary depending on the shooting conditions/circumstances.

Interfaces

Connection Port	USB 2.0 (micro B), HDMI output terminal (Type D), stereo microphone/cable release input terminal (ø3.5 mm connector)
USB Connection	MSC/PTP

Wireless LAN

Standards	IEEE 802.11b/g/n (standard wireless LAN protocol)
Frequency (Center Frequency)	2412 to 2462 MHz (channels: Ch 1 to Ch 11)
Security	Authentication: WPA2 Encryption: AES

Dimensions and Weight

Dimensions	Approx. 125.5 mm (W) × 93.0 mm (H) × 74.0 mm (D) (excluding protrusions)
Weight	Approx. 688 g (including dedicated battery and an SD Memory Card) Approx. 628 g (body only)

Operating Environment

Temperature	-10 to 40°C (14 to 104°F)
Humidity	85% or less (no condensation)

Included Accessories

Package Contents	Strap O-ST132, Rechargeable Lithium-ion Battery D-LI109, Battery Charger D-BC109, AC plug cord, Software (CD-ROM) S-SW168, Start Guide <Mounted to the camera> Eyecup FR, Hot shoe cover FR, Body mount cover
Software	Digital Camera Utility 5

Optional Accessories

GPS Unit	O-GPS1: GPS information (Latitude, Longitude, Altitude, Coordinated Universal Time (UTC)), Direction, Electronic Compass, ASTROTRACER
Cable Release	Cable Switch CS-310

Approximate Image Storage Capacity and Playback Time

(When using the fully charged battery)

Battery	Temperature	Normal Shooting	Flash Photography		Playback Time
			50% Use	100% Use	
D-LI109	23°C	480	410	360	270 minutes

- Tested in compliance with CIPA standard using a fully charged lithium-ion battery at a temperature of 23°C. Actual results may vary depending on the shooting conditions/circumstances.

Approximate Image Storage Capacity by Size

(When using an 8 GB memory card)

Recorded Pixels	JPEG Quality			PEF
	★★★	★★	★	
L 24M	528	1192	2339	151
M 14M	889	1996	3837	–
S 6M	1964	4309	7923	–
XS 2M	4723	9824	16374	–

- The number of storable images may vary depending on the subject, shooting conditions, selected capture mode, and memory card, etc.

Operating Environment for USB Connection and Provided Software

With the provided software “Digital Camera Utility 5”, you can develop RAW images, make color adjustments, or check shooting information on a computer. Install the software from the provided CD-ROM (S-SW168).

We recommend the following system requirements to connect the camera to a computer with a commercially available USB cable and to use the software.

Windows

OS	Windows 10 (32-bit, 64-bit), Windows 8.1 (32-bit, 64-bit), Windows 8 (32-bit, 64-bit), or Windows 7 (32-bit, 64-bit)
CPU	Intel Core 2 Duo or higher
RAM	4 GB or more
HDD	For installing and starting up the program: Approx. 100 MB or more of available space For saving image files: Approx. 10 MB/file (JPEG), Approx. 30 MB/file (RAW)
Monitor	1280×1024 dots, 24-bit full color or higher

Macintosh

OS	OS X 10.11, 10.10, 10.9, 10.8, or 10.7
CPU	Intel Core 2 Duo or higher
RAM	4 GB or more
HDD	For installing and starting up the program: Approx. 100 MB or more of available space For saving image files: Approx. 10 MB/file (JPEG), Approx. 30 MB/file (RAW)
Monitor	1280×1024 dots, 24-bit full color or higher

Memo

- Application software that supports both MOV (MPEG-4AVC/H.264) and AVI (Motion JPEG) formats is required to play back movie files transferred to a computer.

Index

Symbols

menus.....	15
menus.....	20
menu.....	21
menus.....	22
C menus.....	25
mode.....	38
Portrait.....	34
Landscape.....	34
Macro.....	34
Moving Object.....	34
Night Scene Portrait ..	34
Sunset.....	34
Blue Sky.....	34
Forest.....	34
Night Scene.....	35
Night Scene HDR.....	35
Night Snap.....	35
Food.....	35
Pet.....	35
Kids.....	35
Surf & Snow.....	35
Backlight Silhouette...	35
Candlelight.....	35
Stage Lighting.....	35
Museum.....	35
A	
AE-L with AF Locked.....	25
AF Assist Light.....	5
AF coupler.....	5

AF frame.....	33
Aperture Priority Automatic Exposure.....	35
Aperture value.....	35
ASTROPHOTO.....	34
Auto EV Compensation ...	25
Auto Flash + Red-eye.....	39
Auto Flash Discharge.....	39
Auto White Balance (White Balance).....	41
Av mode.....	35
B	
B mode.....	35
Backlight Silhouette (SCN).....	35
Blue Sky (SCN).....	34
Built-in flash.....	39
Bulb Exposure.....	35, 36
Button.....	6
C	
Candlelight (SCN).....	35
Capture mode.....	34
Card.....	29
Card access lamp.....	5
Certification Marks.....	60
Charging the battery.....	28
City names.....	30
CLEAR TONE.....	34
Cloudy (White Balance)...	41

Communication device	44
Control panel.....	10, 12
CTE	41
Custom Setting menus....	25
Customization.....	13
D	
Date Format.....	30
Daylight (White Balance).....	41
Delete.....	42
Delete All Images.....	21
Dial.....	6
Dial indicator.....	32
Digital Camera Utility 5.....	54
Diopter adjustment lever.....	11
Direct keys.....	12
Display Color.....	31
Drive Mode.....	40
DST (daylight saving time).....	30
E	
Electronic Level.....	11
EV Compensation.....	37
Exposure modes.....	35
F	
Firmware Info/Options.....	24

Flash.....	39
Flash compensation.....	39
Flash On.....	39
Flash On + Red-eye.....	39
Flicker Reduction.....	17, 20
Fluorescent - Cool White (White Balance).....	41
Fluorescent - Daylight Color (White Balance).....	41
Fluorescent - Daylight White (White Balance).....	41
Fluorescent - Warm White (White Balance).....	41
Focus indicator.....	33
Focus mode switch.....	32
Food (SCN).....	35
Forest (SCN).....	34
Format.....	31
Four-way controller.....	7, 12
Function restrictions.....	45
G	
Grid Display.....	17
Guide Display.....	32
H	
HDR LANDSCAPE.....	34
Hometown.....	30
Horizon Correction.....	17
Hot shoe.....	5

I			
Image plane indicator	5	Menu	14
Image storage capacity	54	Meter Operating Time	25
Image Sync	44	Microphone.....	5
Image View (Image Sync)	44	Microphone/cable release terminal.....	5
Initial settings.....	30	Mirror	5
Initializing a memory card	31	Mode dial	32
Instant Review	18, 33	Monitor	8, 29
ISO sensitivity.....	37	Mount type.....	48
		Movie menus	20
K		Movie mode	38
Kids (SCN).....	35	Movie SR.....	20
		Moving Object (SCN).....	34
L		Multi Auto White Balance (White Balance).....	41
Landscape (SCN)	34	Museum (SCN).....	35
Language/言語	30		
LCD Display Settings	23	N	
Lens.....	27, 48	Night Scene (SCN)	35
Lens information contacts	5	Night Scene HDR (SCN)	35
Lens mount index	27	Night Scene Portrait (SCN)	34
Lens unlock button	27	Night Snap (SCN).....	35
Lever	6		
Live View	9	O	
		Operating environment....	54
M		Operating Manual.....	68
M mode	35	Other Display Settings....	18
Macintosh	55		
Macro (SCN).....	34	P	
Manual Exposure	35	P mode	35
Manual Flash Discharge..	39	Pet (SCN)	35
Memory card	29	Playback Info Display selection screen	10
		Playback menu	21
		Playback mode	41
		Playback mode palette	43
		Portrait (SCN)	34
		Program Automatic Exposure	35
		Provided software.....	54
		R	
		Rec. Mode menus	15
		Recordable time	38
		Remote Capture (Image Sync)	44
		Remote control receiver	5
		Reset	24, 26
		Retractable lens	32
		S	
		Save RAW Data	33
		Scene modes	34
		SCN mode	34
		Sensitivity	37
		Sensitivity Priority Automatic Exposure	35
		Set-up menus	22
		Shade (White Balance) ...	41
		Shake Reduction	17
		Shooting	32
		Shooting with Live View ..	33
		Shooting with viewfinder..	32
		Shutter & Aperture Priority Automatic Exposure	35
		Shutter Priority Automatic Exposure	35
		Shutter speed	35
		Single Frame Shooting	40
		Single image display	10, 41
		Slow Sync + Red-eye	39
		Slow-speed Sync.....	39
		Sound	38
		Sound Effects	22
		Speaker	5
		Specifications	49
		Stage Lighting (SCN).....	35
		Standby mode	8
		Status Screen	9
		Strap	27
		Strap lug	27
		Sunset (SCN).....	34
		Surf & Snow (SCN).....	35
		Sv mode	35
		Switch.....	6
		T	
		TAv mode	35
		Text Size.....	30
		Thumbnail display.....	42
		Timed exposure.....	36
		Trailing Curtain Sync	39
		Tungsten (White Balance)	41
		Tv mode.....	35
		U	
		USB Connection	54
		User registration	4

V

Viewfinder.....	11
Viewfinder Overlay	17
Volume	22

W

WARRANTY POLICY.....	63
White Balance	41
Wi-Fi	44
Windows	54

Z

Zoom Review	42
-------------------	----

Care to be Taken During Handling

Before Using Your Camera

- When the camera has not been used for a long time, confirm that it is still working properly, particularly prior to taking important pictures (such as at a wedding or when traveling). Contents of the recording cannot be guaranteed if recording, playback or transferring your data to a computer, etc. is not possible due to a malfunction of your camera or recording media (memory cards), etc.

About the Battery and Charger

- To keep the battery in optimum condition, avoid storing it in a fully charged state or in high temperatures.
- If the battery is left inserted and the camera is not used for a long time, the battery will over-discharge and shorten the battery's life.
- Charging the battery a day before use or on the day of use is recommended.
- The AC plug cord provided with this camera is developed exclusively for the battery charger D-BC109. Do not use it with other devices.

Precautions on Carrying and Using Your Camera

- Do not subject the camera to high temperatures or high humidity. Do not leave the camera in a vehicle, as the temperature can get very high.
- Do not subject the camera to strong vibrations, shocks, or pressure. Use a cushion to protect the camera from vibrations of motorcycles, automobiles, or ships.
- The temperature range for camera use is -10°C to 40°C (14°F to 104°F).
- The monitor may appear black at high temperatures, but will return to normal at normal temperatures.
- The monitor may respond more slowly at low temperatures. This is due to liquid crystal properties, and is not a malfunction.

- Sudden temperature changes will cause condensation on the inside and outside of the camera. Place the camera in your bag or a plastic bag, and remove it after temperatures of the camera and surroundings are equalized.
- Avoid contact with garbage, mud, sand, dust, water, toxic gases, or salt. These could cause the camera to breakdown. Wipe the camera to dry off any rain or water drops immediately.
- Do not attach or remove a lens when there are any rain or water drops on the camera. If water enters the camera or the lens, a malfunction may occur.
- Do not press on the monitor with excessive force. This could cause it to break or malfunction.
- Be careful not to overtighten the screw in the tripod socket when using a tripod.

Cleaning Your Camera

- Do not clean the camera with organic solvents such as thinner, alcohol, and benzine.
- Use a lens brush to remove dust accumulated on a lens. Never use a spray blower for cleaning as it may damage the lens.
- Please contact your nearest service center for professional cleaning of the CMOS sensor. (This will involve a fee.)
- Periodic inspections are recommended every one to two years to maintain high performance.

Storing Your Camera

- Do not store the camera with preservatives or chemicals. Storage in high temperatures and high humidity can cause mold to grow on the camera. Remove the camera from its case and store it in a dry and well-ventilated place.
- Avoid using or storing the camera where it may be exposed to static electricity or electrical interference.
- Avoid using or storing the camera in direct sunlight or in locations where it may be exposed to rapid changes in temperature or to condensation.

About SD Memory Cards

- The SD Memory Card is equipped with a write-protect switch. Setting the switch to LOCK prevents new data from being recorded on the card, the stored data from being deleted, and the card from being formatted by the camera or computer.
- The SD Memory Card may be hot when removing the card immediately after using the camera.
- Do not remove the SD Memory Card or turn off the power while the card is being accessed. This may cause the data to be lost or the card to be damaged.
- Do not bend the SD Memory Card or subject it to violent impact. Keep it away from water and store away from high temperatures.
- Do not remove the SD Memory Card while formatting. The card may be damaged and become unusable.
- Data on the SD Memory Card may be deleted in the following circumstances. We do not accept any liability for data that is deleted if
 1. the SD Memory Card is mishandled by the user.
 2. the SD Memory Card is exposed to static electricity or electrical interference.
 3. the SD Memory Card has not been used for a long time.
 4. the SD Memory Card or the battery is removed while the card is being accessed.
- If the SD Memory Card is not used for a long time, the data on the card may become unreadable. Be sure to regularly make a backup of important data on a computer.
- Format new SD Memory Cards. Also format SD Memory Cards previously used with other cameras.
- Please note that deleting data stored on an SD Memory Card, or formatting an SD Memory Card does not completely erase the original data. Deleted data can sometimes be recovered using commercially available software. If you are going to discard, give away or sell your SD Memory Card, you should ensure that the data on the card is completely deleted or the card itself is destroyed if it contains any personal or sensitive information.
- The data on your SD Memory Card should be managed at your own risk.

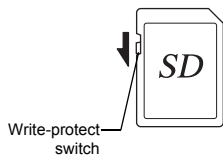

About the Wireless LAN Function

- Do not use the camera in a place where electrical products, AV/OA devices, and so on generate magnetic fields and electromagnetic waves.
- If the camera is affected by magnetic fields and electromagnetic waves, it may not be able to communicate.
- If the camera is used near a TV or a radio, poor reception or TV screen glitch may occur.
- If there are multiple wireless LAN access points near the camera and the same channel is used, search operation may not be executed correctly.
- The security of your data stored, sent or received is your own responsibility.

In the frequency band used by the camera, along with industrial, scientific, and medical devices such as microwave ovens, premises radio stations (wireless stations requiring license) and specified low power radio stations (wireless stations not requiring license) for mobile object identification used in factory production lines, etc., and amateur radio stations (wireless stations requiring license) are operated.

1. Before using the camera, confirm that premises radio stations and specified low power radio stations for mobile object identification and amateur radio stations are not operated in the vicinity.
2. In the event that the camera causes harmful radio wave interference to premises radio stations for mobile object identification, immediately change the frequency being used to avoid interference.
3. If you have other troubles such that the camera causes harmful radio wave interference to specified low power radio stations for mobile object identification or to amateur radio stations, contact your nearest service center.

This camera conforms to the technical standards under the Radio Law and Telecommunications Business Law and the certification of conformance to technical standards can be displayed on the monitor.

The certification marks of conformance to wireless technical standards under the Radio Law and Telecommunications Business Law can be displayed from [Certification Marks] of the 5 menu. Refer to "Using the Menus" (p.14) for how to use the menus.

Trademarks

- Microsoft and Windows are registered trademarks of Microsoft Corporation in the United States of America and other countries.
- Macintosh, OS X, QuickTime, and App Store are trademarks of Apple Inc., registered in the U.S. and other countries.
- Intel and Intel Core are trademarks of Intel Corporation in the U.S. and/or other countries.
- SDXC Logo is a trademark of SD-3C, LLC.
- Google, Google Play, and Android are trademarks or registered trademarks of Google Inc.
- Wi-Fi is a registered trademark of Wi-Fi Alliance.
- IOS is a trademark or registered trademark of Cisco in the U.S. and other countries and is used under license.
- This product includes DNG technology under license by Adobe Systems Incorporated.
- The DNG logo is either a registered trademark or trademark of Adobe Systems Incorporated in the United States and/or other countries.
- HDMI, the HDMI logo and High-Definition Multimedia Interface are trademarks or registered trademarks of HDMI Licensing, LLC in the United States and/or other countries.

All other trademarks are the property of their respective owners.

- This product uses the RICOH RT font designed by Ricoh Company Ltd.
- This product supports PRINT Image Matching III. PRINT Image Matching enabled digital still cameras, printers and software help photographers to produce images more faithful to their intentions. Some functions are not available on printers that are not PRINT Image Matching III compliant.

Copyright 2001 Seiko Epson Corporation. All Rights Reserved. PRINT Image Matching is a trademark of Seiko Epson Corporation. The PRINT Image Matching logo is a trademark of Seiko Epson Corporation.



AVC Patent Portfolio License

This product is licensed under the AVC Patent Portfolio License for the personal use of a consumer or other uses in which it does not receive remuneration to (i) encode video in compliance with the AVC standard ("AVC video") and/or (ii) decode AVC video that was encoded by a consumer engaged in a personal activity and/or was obtained from a video provider licensed to provide AVC video. No license is granted or shall be implied for any other use.

Additional information may be obtained from MPEG LA, L.L.C.
See <http://www.mpegla.com>.

Announcement on the Use of BSD-Licensed Software

This product includes software licensed under the BSD License. BSD license is a form of license which permits the redistribution of the software provided that it is clearly stated that use is unwarranted, and a copyright notice and a list of licensing conditions are provided. The following contents are displayed based on the abovementioned licensing conditions and are not for the purpose of restricting your use of the product, etc.

Tera Term

Copyright (C) 1994-1998 T. Teranishi

(C) 2004-2016 TeraTerm Project

All rights reserved.

Redistribution and use in source and binary forms, with or without modification, are permitted provided that the following conditions are met:

1. Redistributions of source code must retain the above copyright notice, this list of conditions and the following disclaimer.
2. Redistributions in binary form must reproduce the above copyright notice, this list of conditions and the following disclaimer in the documentation and/or other materials provided with the distribution.
3. The name of the author may not be used to endorse or promote products derived from this software without specific prior written permission.

THIS SOFTWARE IS PROVIDED BY THE AUTHOR "AS IS" AND ANY EXPRESS OR IMPLIED WARRANTIES, INCLUDING, BUT NOT LIMITED TO, THE IMPLIED WARRANTIES OF MERCHANTABILITY AND FITNESS FOR A PARTICULAR PURPOSE ARE DISCLAIMED. IN NO EVENT SHALL THE AUTHOR BE LIABLE FOR ANY DIRECT, INDIRECT, INCIDENTAL, SPECIAL, EXEMPLARY, OR CONSEQUENTIAL DAMAGES (INCLUDING, BUT NOT LIMITED TO, PROCUREMENT OF SUBSTITUTE GOODS OR SERVICES; LOSS OF USE, DATA, OR PROFITS; OR BUSINESS INTERRUPTION) HOWEVER CAUSED AND ON ANY THEORY OF LIABILITY, WHETHER IN CONTRACT, STRICT LIABILITY, OR TORT (INCLUDING NEGLIGENCE OR OTHERWISE) ARISING IN ANY WAY OUT OF THE USE OF THIS SOFTWARE, EVEN IF ADVISED OF THE POSSIBILITY OF SUCH DAMAGE.

WARRANTY POLICY

All our cameras purchased through authorized bona fide photographic distribution channels are guaranteed against defects of material or workmanship for a period of twelve months from the date of your purchase. Service will be rendered, and defective parts will be replaced without cost to you within that period, provided the camera does not show evidence of impact, sand or liquid damage, mishandling, tampering, battery or chemical corrosion, operation contrary to operating instructions, or modification by an unauthorized repair shop. The manufacturer or its authorized representatives shall not be liable for any repair or alterations except those made with its written consent and shall not be liable for damages from delay or loss of use or from other indirect or consequential damages of any kind, whether caused by defective material or workmanship or otherwise; and it is expressly agreed that the liability of the manufacturer or its representatives under all guarantees or warranties, whether expressed or implied, is strictly limited to the replacement of parts as hereinbefore provided. No refunds will be made on repairs by non-authorized service facilities.

Procedure During 12-month Warranty Period

Any camera which proves defective during the 12-month warranty period should be returned to the dealer from whom you purchased the camera or to the manufacturer. If there are no representatives of the manufacturer in your country, send the camera to the manufacturer, with postage prepaid. In this case, it will take a considerable length of time before the camera can be returned to you owing to the complicated customs procedures required. If the camera is covered by warranty, repairs will be made and parts replaced free of charge, and the

camera will be returned to you upon completion of servicing. If the camera is not covered by warranty, regular charges of the manufacturer or of its representatives will apply. Shipping charges are to be borne by the owner. If your camera was purchased outside of the country where you wish to have it serviced during the warranty period, regular handling and servicing fees may be charged by the manufacturer's representatives in that country. Notwithstanding this, your camera returned to the manufacturer will be serviced free of charge according to this procedure and warranty policy. In any case, however, shipping charges and customs clearance fees to be borne by the sender. To prove the date of your purchase when required, please keep the receipt or bills covering the purchase of your camera for at least a year. Before sending your camera for servicing, please make sure that you are sending it to the manufacturer's authorized representatives or their approved repair shops, unless you are sending it directly to the manufacturer. Always obtain a quotation for the service charge, and only after you accept the quoted service charge, instruct the service station to proceed with the servicing.

- **This warranty policy does not affect the customer's statutory rights.**
- **The local warranty policies available from our distributors in some countries can supersede this warranty policy. Therefore, we recommend that you review the warranty card supplied with your product at the time of purchase, or contact our distributor in your country for more information and to receive a copy of the warranty policy.**

For customers in USA

STATEMENT OF FCC COMPLIANCE

This device complies with Part 15 of the FCC Rules. Operation is subject to the following two conditions: (1) This device may not cause harmful interference, and (2) this device must accept any interference received, including interference that may cause undesired operation. Changes or modifications not approved by the party responsible for compliance could void the user's authority to operate the equipment.

This equipment has been tested and found to comply with the limits for a Class B digital device, pursuant to part 15 of the FCC Rules.

These limits are designed to provide reasonable protection against harmful interference in a residential installation. This equipment generates, uses and can radiate radio frequency energy and, if not installed and used in accordance with the instructions, may cause harmful interference to radio communications. However, there is no guarantee that interference will not occur in a particular installation. If this equipment does cause harmful interference to radio or television reception, which can be determined by turning the equipment off and on, the user is encouraged to try to correct the interference by one or more of the following measures:

- Reorient or relocate the receiving antenna.
- Increase the separation between the equipment and receiver.
- Connect the equipment into an outlet on a circuit different from that to which the receiver is connected.

* Consult the dealer or an experienced radio/TV technician for help.

FOR CALIFORNIA, U.S.A. ONLY

Perchlorate Material-special handling may apply.

The lithium battery used in this camera contains perchlorate material, which may require special handling.

See www.dtsc.ca.gov/hazardouswaste/perchlorate

Declaration of Conformity

According to 47CFR, Parts 2 and 15 for
Class B Personal Computers and Peripherals

We: RICOH IMAGING AMERICAS
CORPORATION

Located at: 633 17th Street, Suite 2600
Denver, Colorado 80202 U.S.A.
Phone: 800-877-0155
FAX: 303-790-1131

Declare under sole responsibility that the product identified herein complies with 47CFR Parts 2 and 15 of the FCC rules as a Class B digital device. Each product marketed is identical to the representative unit tested and found to be compliant with the standards. Records maintained continue to reflect the equipment being produced can be expected to be within the variation accepted, due to quantity production and testing on the statistical basis as required by 47CFR §2.909. Operation is subject to the following two conditions: (1) This device may not cause harmful interference, and (2) This device must accept any interference received, including interference that may cause undesired operation. The above named party is responsible for ensuring that the equipment complies with the standards of 47CFR §15.101 to §15.109.

Product Name: SLR Digital Camera

Model Number: PENTAX K-70

Contact person: Customer Service Manager

Date and Place: April, 2016 Colorado

For customers in Canada
Industry Canada (IC) Compliance Notice

This Class B digital apparatus complies with Canadian ICES-003 (B).

This device complies with Industry Canada licence-exempt RSS standard(s). Operation is subject to the following two conditions: (1) this device may not cause interference, and (2) this device must accept any interference, including interference that may cause undesired operation of the device.

The available scientific evidence does not show that any health problems are associated with using low power wireless devices. There is no proof, however, that these low power wireless devices are absolutely safe. Low power wireless devices emit low levels of radio frequency energy (RF) in the microwave range while being used. Whereas high levels of RF can produce health effects (by heating tissue), exposure of low-level RF that does not produce heating effects causes no known adverse health effects. Many studies of low-level RF exposures have not found any biological effects. Some studies have suggested that some biological effects might occur, but such findings have not been confirmed by additional research. The K-70 has been tested and found to comply with IC radiation exposure limits set forth for an uncontrolled environment and meets RSS-102 of the IC radio frequency (RF) Exposure rules.

Pour les utilisateurs au Canada
Industrie Canada (IC) Avis de Conformité

Cet appareil numérique de la classe B est conforme à la norme NMB-003 (B) du Canada.

Le présent appareil est conforme aux CNR d'Industrie Canada applicables aux appareils radio exempts de licence. L'exploitation est autorisée aux deux conditions suivantes : (1) l'appareil ne doit pas produire de brouillage, et (2) l'utilisateur de l'appareil doit accepter tout brouillage radioélectrique subi, même si le brouillage est susceptible d'en compromettre le fonctionnement.

Les connaissances scientifiques dont nous disposons n'ont mis en évidence aucun problème de santé associé à l'usage des appareils sans fil à faible puissance. Nous ne sommes cependant pas en mesure de prouver que ces appareils sans fil à faible puissance sont entièrement sans danger. Les appareils sans fil à faible puissance émettent une énergie fréquence radioélectrique (RF) très faible dans le spectre des micro-ondes lorsqu'ils sont utilisés. Alors qu'une dose élevée de RF peut avoir des effets sur la santé (en chauffant les tissus), l'exposition à de faibles RF qui ne produisent pas de chaleur n'a pas de mauvais effets connus sur la santé. De nombreuses études ont été menées sur les expositions aux RF faibles et n'ont découvert aucun effet biologique. Certaines études ont suggéré qu'il pouvait y avoir certains effets biologiques, mais ces résultats n'ont pas été confirmés par des recherches supplémentaires. Le K-70 a été testé et jugé conforme aux limites d'exposition aux rayonnements IC énoncées pour un environnement non contrôlé et respecte les règles d'exposition aux fréquences radioélectriques (RF) CNR-102 de l'IC.

For Customers in Europe

Information for Users on Collection and Disposal of Old Equipment and Used Batteries



1. In the European Union

These symbols on the products, packaging and/or accompanying documents mean that used electrical and electronic equipment and batteries should not be mixed with general household waste.

Used electrical/electronic equipment and batteries must be treated separately and in accordance with legislation that requires proper treatment, recovery and recycling of these products.



By disposing of these products correctly you will help ensure that the waste undergoes the necessary treatment, recovery and recycling and thus prevent potential negative effects on the environment and human health which could otherwise arise due to inappropriate waste handling.

If a chemical symbol is added beneath the symbol shown above, in accordance with the Battery Directive, this indicates that a heavy metal (Hg = Mercury, Cd = Cadmium, Pb = Lead) is present in the battery at a concentration above an applicable threshold specified in the Battery Directive.

For more information about collection and recycling of used products, please contact your local authorities, your waste disposal service or the point of sale where you purchased the products.

2. In other countries outside the EU

These symbols are only valid in the European Union. If you wish to discard used products, please contact your local authorities or dealer and ask for the correct method of disposal.

For Switzerland: Used electrical/electronic equipment can be returned free of charge to the dealer, even when you don't purchase a new product. Further collection facilities are listed on the home page of www.swico.ch or www.sens.ch.

Notice to Users in EEA Countries

This product complies with the essential requirements and provisions of RE Directive 2014/53/EU.

The CE Declaration of Conformity is available by accessing the URL:

<http://www.ricoh-imaging.co.uk/en/Photo-Downloads.html>
and selecting the product applicable.

Operating frequency band: 2400 MHz - 2483.5 MHz
Maximum radio-frequency power: 8.16 dBm EIRP

European importer: RICOH IMAGING EUROPE S.A.S.
Parc Tertiaire SILIC 7-9, avenue Robert Schuman - B.P. 70102,
94513 Rungis Cedex, FRANCE
(<http://www.ricoh-imaging.eu>)

Manufacturer: RICOH IMAGING COMPANY, LTD.
1-3-6, Nakamagome, Ohta-ku, Tokyo 143-8555, JAPAN
(<http://www.ricoh-imaging.co.jp>)



The CE Mark is a Directive conformity mark of the European Union.

Information on the Operating Manual

An Operating Manual (PDF) containing information on how to use this camera is available. Please download it from our website.

Operating Manual Download:

<http://www.ricoh-imaging.com/manuals/>



Memo

RICOH IMAGING COMPANY, LTD.

1-3-6, Nakamagome, Ohta-ku, Tokyo 143-8555, JAPAN
(<http://www.ricoh-imaging.co.jp>)

**RICOH IMAGING EUROPE
S.A.S.**

Parc Tertiaire SILIC 7-9, avenue Robert Schuman - B.P. 70102,
94513 Rungis Cedex, FRANCE
(<http://www.ricoh-imaging.eu>)

**RICOH IMAGING AMERICAS
CORPORATION**

633 17th Street, Suite 2600, Denver, Colorado 80202, U.S.A.
(<http://www.us.ricoh-imaging.com>)

**RICOH IMAGING CANADA
INC.**

5520 Explorer Drive Suite 300, Mississauga, Ontario, L4W 5L1, CANADA
(<http://www.ricoh-imaging.ca>)

**RICOH IMAGING CHINA CO.,
LTD.**

23D, Jun Yao International Plaza, 789 Zhaojiabang Road, Xu Hui District,
Shanghai, 200032, CHINA
(<http://www.ricoh-imaging.com.cn>)

<http://www.ricoh-imaging.co.jp/english>

This contact information may change without notice.
Please check the latest information on our websites.

- Specifications and external dimensions are subject to change without notice.