



Prestigio

10 YEARS IN THE ART OF HI-TECH



MultiPhone 5000 DUO

PAP5000_DUO

Android Smartphone

User Manual

Common information

Dear Customer,

Thank you for choosing MultiPhone PAP5000DUO Smartphone. Before starting to use the smartphone, please read this manual carefully to discover all its features. Please save this manual and refer to it in the future if you have questions concerning your device.

This manual contains safety information, technical specifications of Prestigio MultiPhone PAP5000DUO Smartphone, preinstalled software basic features, setup and other useful information, which will help you to improve your use of the device, Android operating system and applications.

For information about meaning of the terms used in this manual, please refer to the "Glossary" section at the end of this manual, as well as to other open information sources or Prestigio customer support line.

Contents

1. Product Overview

- 1.1 Package Contents
- 1.2 Device Overview

2. Getting Started

- 2.1 Insert a SIM card
- 2.1 Insert and charge the battery
- 2.2 Using the storage card
- 2.3 Hot plug of storage card
- 2.4 Memory space
- 2.5 Power on/off and Device Reset
- 2.6 Startup Wizard

3. Home Screen

- 3.1 Status and notifications
- 3.2 Shortcuts to Add widgets
- 3.3 Finger gestures
- 3.4 Coping files to and from the storage card
- 3.5 Searching the device and the web

4. Personalizing

- 4.1 Change your wallpaper
- 4.2 Personalize your Home screen with folders
- 4.3 Rearrange widgets and shortcuts on your Home screen

5. Communication

- 5.1 Contacts
- 5.2 Making a Phone call
- 5.3 Messaging

6. Web browsing

7. Manage Applications

8. Typical applications introduction

- 8.1 Music Player
- 8.2 Video Player
- 8.3 Gallery
- 8.4 File Manager
- 8.5 Instant Messaging tools
- 8.6 E-mails
- 8.7 Camera

9.Prestigio preinstalled applications

10. Settings

- 10.1 SIM management
- 10.2 Wireless & networks
- 10.3 Audio Profiles
- 10.4 Display
- 10.5 Storage
- 10.6 Battery
- 10.7 Apps
- 10.8 Accounts& Sync
- 10.9 Location service
- 10.10 Security settings
- 10.11 Language & input setting
- 10.12 Backup &reset

- 10.13 Date & Time setting
- 10.14 Schedule power on/off
- 10.15 Accessibility
- 10.16 Developer options
- 10.17 About smartphone

11. Troubleshooting

- 11.1 Force shutdown
- 11.2 Restore default settings
- 11.3 System updating

12. Glossary

Appendix A. eReader Prestigio (Application Manual)

Disclaimer

As the Prestigio products are constantly updated and improved, your device's software may have a slightly different appearance or modified functionality than presented in this User Manual. We make every effort to ensure that the information and procedures in this user manual are accurate and complete. No liability can and will be accepted for any errors or omissions. Prestigio reserves the right to make any changes without further notice to any products herein.

About Android

An Android phone can perform many functions as a computer. You can also adjust it to better suit your needs, to receive the information you want and have fun at the same time. You can add and delete applications, or enhance them to improve functionality. In Android Market you can download a range of applications and games from a constantly growing collection. You can also integrate applications on your Android phone with your personal data and online accounts. For example, you can back up your track of your appointments and engage in as much social networking as you like.

Applications

An application is a phone program that helps you perform a task. For example, there are applications to make calls, take photos and download more applications.

Note: The colors and specifications shown/mentioned in the user manual may differ from the actual product. Images shown are for representation purpose only.

Important Safety Instructions

Your Prestigio MultiPhone PAP5000DUOSmartphone is manufactured and designed for mobile usage.

Please read the following instructions carefully. It helps you to use your device without safety issues and keep your Smartphone in good working condition:

1. Do not place objects on top of the MultiPhone as objects may scratch the screen.
2. MultiPhone should be kept away from extreme changes of temperature.
3. Protect it from direct sunlight or heat sources.
4. Protect the device from moisture and from dusty or smoky environment as it can harm the smartphone.
5. Keep your MultiPhone away from contact with active chemicals.
6. Do not place the MultiPhone on an uneven or unstable surface. Fall of the device can cause damage to the LCD screen which is not covered with warranty.
7. Do not expose the MultiPhone to strong magnetic or electrical field.
8. Protect your MultiPhone from hits and extreme pressure.
9. Operation Temperature: This MultiPhone should only be used in environments with ambient temperatures between 0°C (32°F) and 50°C(122°F).
10. Do not insert into MultiPhone devices or items not matching to standard sockets on it.
11. Do not use MultiPhone in the rain - it is NOT a waterproof device. Protect the MultiPhone from dust, dirt and high humidity.
12. Do not use Your MultiPhone during driving.
13. Use only manufacturer approved chargers. Using non-original chargers may cause damage of the device and be harmful to your health.
14. The MultiPhone and the adapter may produce some heat during normal operation or charging. Avoid placing it to the soft surfaces, other places and conditions which may prevent normal dispersion of the heat, causing device overheating.
15. Disconnect the MultiPhone from an electrical outlet after it is charged.
16. Do not use a pen or any sharp object to tap the screen. Clean the touch screen with a soft cloth. If needed, dampen the cloth slightly before cleaning. Never use abrasives or cleaning solutions.
17. DO NOT disassemble the MultiPhone, only a Prestigio certified service technician should perform repair.
18. Always power off the MultiPhone to install or remove external devices, SIM and memory cards, the MultiPhone does not support hot-plug installation of such items.
19. Your MultiPhone must be switched off during airplane take-off and landing.

Safety instruction for using the touch screen

Touch screen enables you to select items or perform function. To avoid any damage or malfunction, please note following:

1. Do not press the touch screen with your fingertips or use sharp tools on the touch screen.
2. Do not allow the touch screen to come into contact with other electrical devices. Electrostatic discharges can cause the touch screen to malfunction.
3. Do not allow the touch screen to come into contact with liquids. The touch screen may malfunction in humid conditions or when exposed to liquids.
4. Leaving the touch screen idle for extended periods may result in afterimages (screen burn-in) or ghosting. Turn off the touch screen when you do not use the device.
5. For optimal use of touch screen, remove the screen protection film before using your device.
6. Your touch screen has layer that detects small electrical charges emitted by the human body. For best performance tap the touch screen with your fingertip. The touch screen will not react to touches from sharp objects, such as stylus or pen

Warranty Information

Prestigio MultiPhone PAP5000 DUO warranty period is 2 years.

Warranty information could be found at <http://www.prestigio.com/support/warranty-terms>

Prestigio MultiPhone PAP5000DUO Smartphone life cycle is 2 years.

1. Product Overview



1.1 Package Content:

- Prestigio MultiPhone 5000 DUO (PAP5000_DUO) – 1x
- AC Adapter – 1x
- Earphones – 1x
- USB Cable – 1x
- Quick Start Guide – 1x
- Warranty Card – 1x
- Legal and Safety Notices – 1x
- Li-Polymer Battery – 1x
- Pouch - 1x

1.2 Device Overview

Control Buttons and Connectivity:

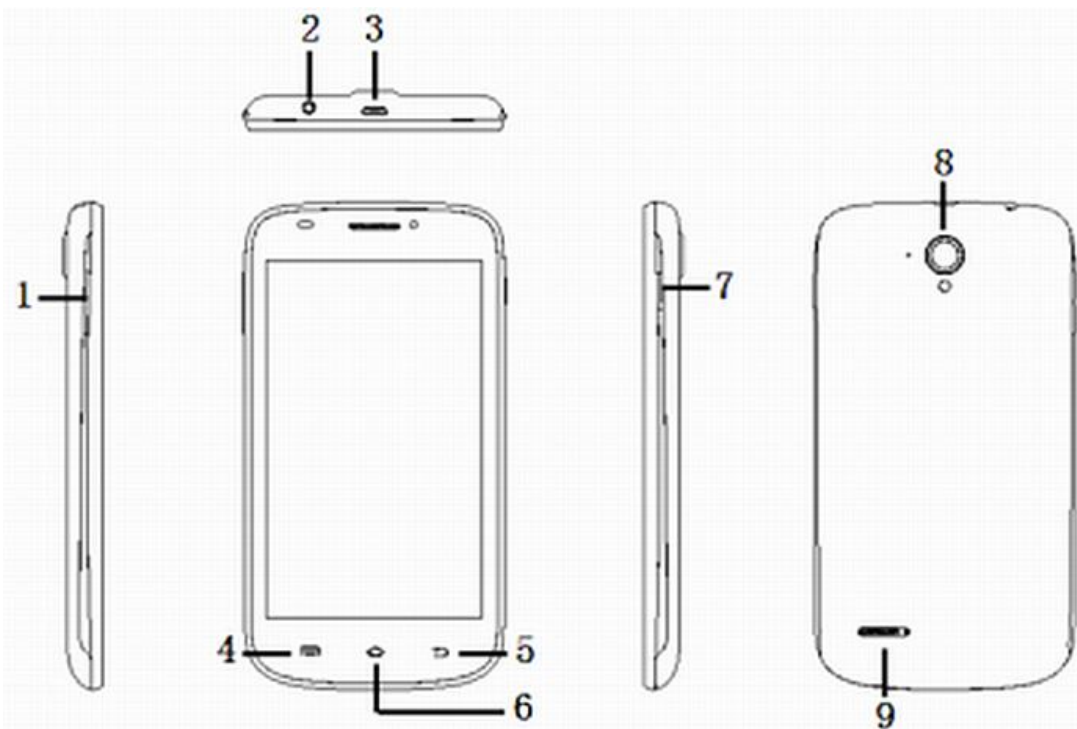

1	Volume +/-	Adjust the volume level
2	Earphone Jack	Earphone connection
3	Micro USB port	USB cable/ DC charger connection
4	Menu Button	Displays Menu options
5	Back Button	Back to the previous page

6	Home	Back to Home screen
7	Power button	Turn on/off the device, suspend / resume the device
8	Camera	Take photos/record video
9	Speaker	Listen to the phone calls or music

Technical Specifications:

Processor	
CPU	ARM Cortex A9 (MTK 6577)
CPU Internal Clock Rate	1.2 GHz
Display	
Display Size	5.0 inches
Display Resolution	480x800
Display Technology	TFT LCD
Display Features	Capacitive multi touch screen
Screen rotation	G-Sensor
Memory	
Internal Memory Size	4 GB
Installed RAM Storage Capacity	512 Mb
Flash Card Support	Micro SDHC up to 32 GB
Interfaces	
Interface ports available	Wi-Fi, Micro SD/SHDC/SDXC, Micro USB 2.0
Interface Wi-Fi	IEEE 802.11b/g/n, Wi-Fi hotspot
Interface Bluetooth	Bluetooth 2.1
Interface USB	1 x micro USB
Interface Audio	1 x 3.5 mm mini jack
Multimedia	
Digital Camera	Front : 0.3 Mpix / Back: 5 Mpix
Supported Audio Formats	FLAC, APE, AAC, MP3, WMA, OGG, WAV
Supported Picture Formats	GIF, JPG, PNG, BMP
Supported Video Formats	VC-1, M-JPEG, MPEG-2, MPEG-4, H.263, H.264, RMVB, WMV
Software	
Operating System	Android 4.0
Network	
Bands	GSM 1900, GSM 850, GSM 900, WCDMA 2100, WCDMA 900, GSM 1800
Data Transfer Protocols	EDGE, GPRS, HSDPA
Navigation/GPS	A-GPS, GPS
Battery	
Battery Technology	Lithium Ion Polymer
Battery Current Capacity	2200 mAh
Battery Talk Time	Up to 6hr
Battery Standby Time	Up to 320hr
Miscellaneous	
Construction	Monoblock
SIM Card	Dual SIM
Sensors	Ambient Light Sensor, G-Sensor, Proximity Sensor
Included Accessories	USB Cable, Protective Pouch, Earphones, Charging Device
Warranty	
Warranty Term (month)	24 months
Temperature and Humidity	
Storage Temperature	0°C (32°F) ~ +45°C (113°F)
Operation Temperature	0°C (32°F) ~ +45°C (113°F)
Storage Relative Humidity	0% ~ 90%, Non-Condensed
Operating Relative Humidity	0% ~ 90%, Non-Condensed

2. Getting Started

2

2.1 Insert a SIM card

Before you start using your MultiPhone, you may need to insert your Micro SIM card. If no card is installed, the message “No SIM card” appears on the phone’s lock screen.

If you don't have a SIM card inserted in your mobile phone, you cannot connect to mobile networks for voice and data services as well as SMS messaging. At the same time you can connect to Wi-Fi network to sign into your Google and Prestigio accounts, browse the Web (via WiFi only) and to use other features of your phone.

Your phone has 2 SIM card slots, which are located on its back side and protected with a back cover. Remove the back cover as shown on the picture below and insert the SIM cards into respective slots.

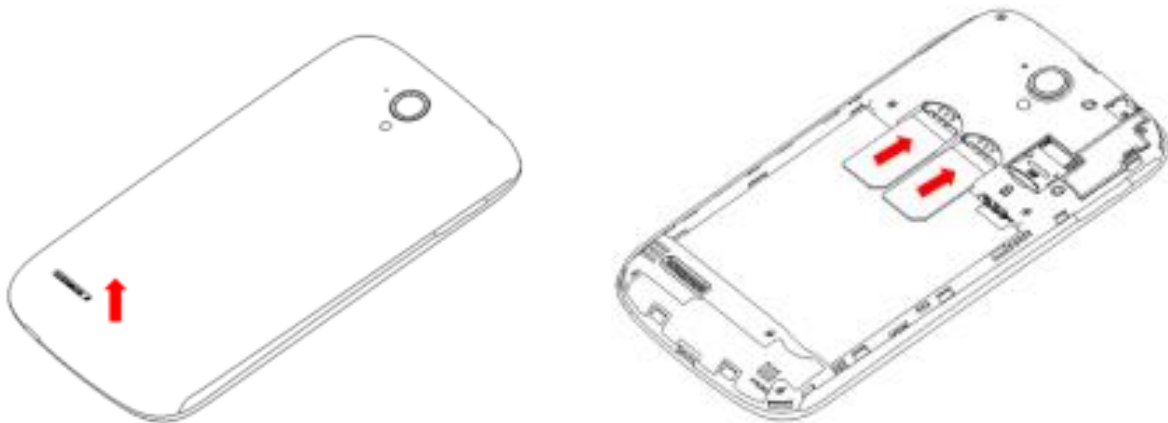

2.2 Insert and charge the battery

Prestigio MultiPhone comes with a Lithium-Ion Polymer rechargeable battery and is designed to use only manufacture-specified original batteries and accessories.

In order to install the battery please remove the back cover and put the battery into the battery compartment, matching its contacts to the contacts of the phone set.

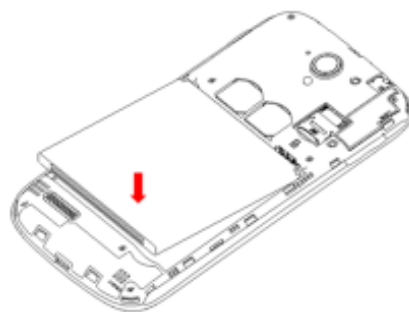

You can see battery status on status bar of MultiPhone in the lower right corner of the home screen. Android OS has battery charge detection system and notify user if battery charge is low and

device need to be connected to AC adapter. If you will see such message, or your device couldn't power on, connect original AC power adapter to charge your device. Plug one end of the adapter into the power jack of the device, and the other to the power socket (see the picture below).



To extend the battery operation life, wait for finish of charge process. Please, fully charge your new device after unpacking.

Alternatively, you can charge your smartphone by connecting it via USB cable to the USB port of computer. But please be informed, that in this case, due to lower power output of USB bus, the charging can take more time.

[Note]: it is normal if the device is warm or hot during charging, you can use it as usual, just follow the respective security precautions.

Please be informed, that Li-Ion battery is considered to be a consumable part of your MultiPhone, it's rated capacity might fall up to 50% during first two years from the date of purchase; such reduction of capacity is not a defect and is not covered with warranty.



DO NOT throw the battery in municipal waste.

2.2 Using the storage card

Your new Prestigio MultiPhone 5000 DUO (PAP5000DUO) Smartphone is equipped with Micro SD card slot to extend available device memory. It is compatible with Micro SD/ Micro SDHC/ TF-Flash card formats of size up to 32Gb. Proper functioning of larger capacity cards is not guaranteed.

Insert the storage card

The storage card slot is located on the back side of the device, next to SIM card slots, and is protected with a back cover.

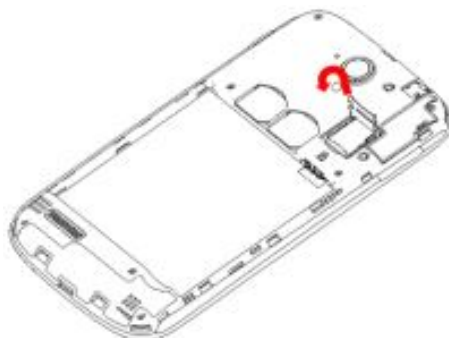

To insert a card, remove the back cover from the phone, place the card in the tray, flip it and move towards to lock (see the respective signs on the memory card tray).

DO NOT push the card or its tray too strong, this could damage the card tray or the storage card itself.

Browse files in the storage card

To browse the files you should do one of the following:

- Select “**Explorer**” icon to view files in the storage card;
- You can also install and run any other third party file browser applications.

Remove the storage card

To avoid data loss or damage, please stop using files/programs in the storage card, and then tap **Settings> Storage> Unmount SD card** to remove it safely.

To remove the storage card, unlock the memory card tray, open it and pull the card

[Note]:

1. Make sure the location and direction of the storage card is correct when inserting.
2. To avoid possible issues or incompatibility of the storage card with your MultiPhone, major brands of storage card are recommended. Never use damaged or cracked storage cards as this might damage the MultiPhone or cause loss of your data

2.3 Hot plug of storage card

Please do not hot plug the storage card when using or browsing its files.

For example, when you are running the Music/Video Player/ Gallery, the storage card could be damaged and files on it might become corrupt if you take out the storage card without proper preparation. As for details of inserting/removing storage card, see **2.2 Use the storage card**.

2.4 Memory space

The capacity of built-in flash chip is 4GB. The device contains 2 memory partitions: Internal storage & NAND Flash storage. The space is partitioned to store apps, setting and user data. A part of storage will be reserved for system resources and wouldn't be available for user. The exact size of available memory may vary depending on Firmware version.

MultiPhone supports extended storage – micro SD cards of 32GB maximum capacity.

2.5 Power on/off

1. **Power on:** press down the Power Button and hold it for a while to turn on the device when the battery is full enough.
2. **Power off:** press down the Power Button and hold it for about 3 seconds and then select **Power Off** in popup menu to turn off the device.
3. **Screen Lock:** short-press down the Power Button once to shutdown the screen to save battery life. Short-press down the Power Button again to activate the lock screen. After unlocking, the device will resume the screen before locking.

Your device turns off the touch screen when you do not use it for a specified period. You can set

the length of time that the device waits before turning off the screen. See **Settings/Display/Screen timeout**. You can also set customized pattern, PIN or password to unlock the screen. See **Settings/Location & Security settings/Change screen lock**.

2.6 Startup Wizard

Prestigio Startup Wizard will guide you through the initial setup of your MultiPhone. It appears at first start and consists of several steps. Following information will help you to avoid issues during that stage.

Right after the switch on and boot sequence, if you had already installed the SIM card(s) a PIN code request menu will appear. Use the numeric keypad to enter the PIN and confirm it by OK button.

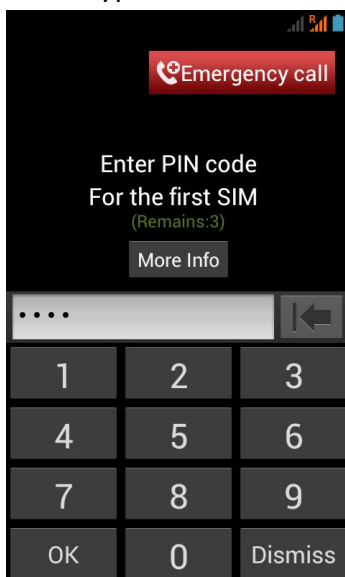

Please pay attention to the correct input of the PIN code, in case of 3 wrong attempts the SIM card will be blocked and you'll need a PUK code to unblock it (refer to you SIM card manual or mobile network provider for PIN and PUK codes info)

If you have two SIM cards installed – pls enter the respective PIN for another card to activate it as well. Upon completing this stage system will inform you of successful SIM card connection:

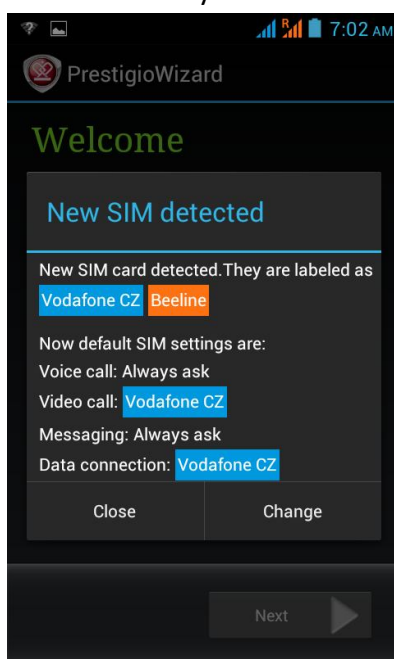

You may choose Close to proceed with Startup Wizard or change the settings by choosing Change (see Settings chapter for details)

Welcome! Screen appears after this. It allows you to choose the desired language of the operational system of Prestigio MultiPhone. Tap “Change language” button to access a list of available languages. You can select the language you need in this list, than you’ll return back to the Welcome screen. Tap Next, read and accept End User License agreement to continue

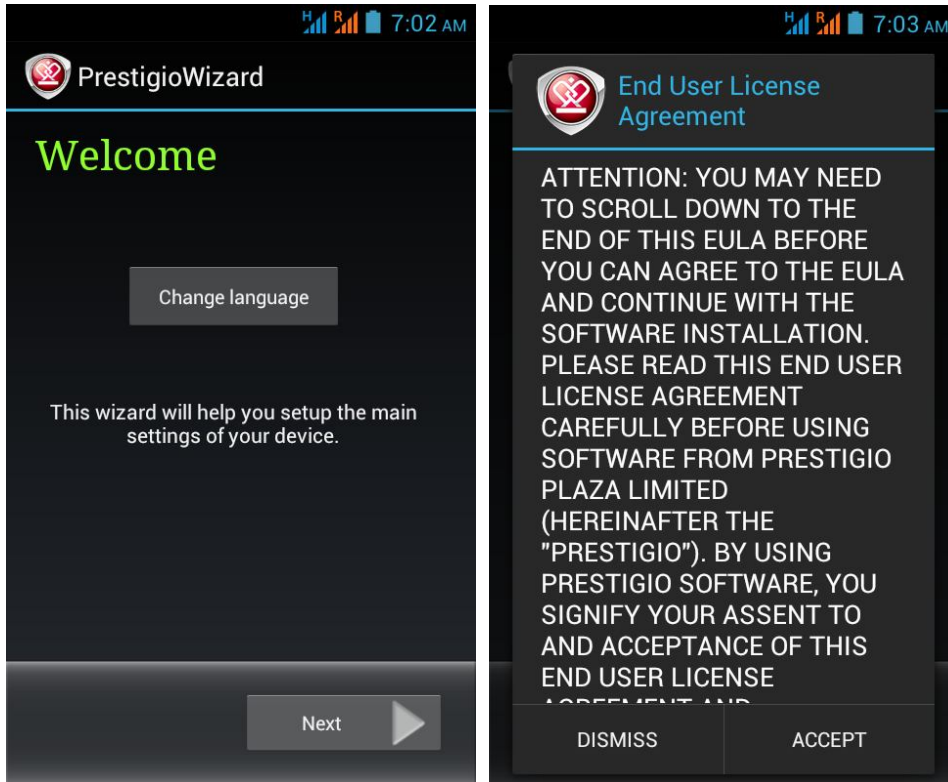

Keyboard Input Language screen provides users with option to select the necessary layouts of Android Keyboard.

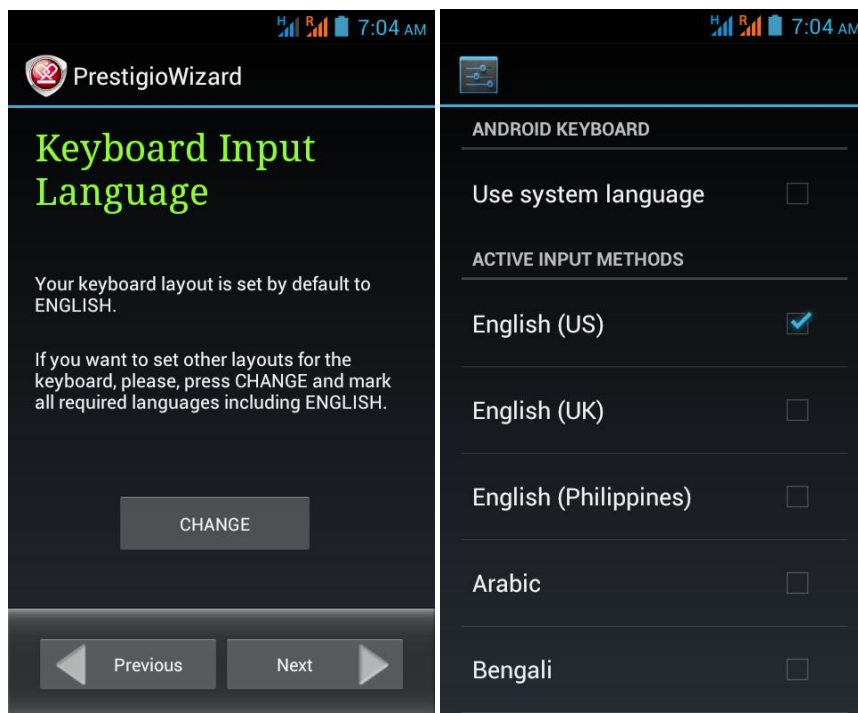

You may keep the keyboard in a system language or select several layouts (e.g. English (US) and German) by checking respective checkboxes.

Tap **Back** button and  to continue when ready.

Date and Time screen has to be used for exact Time Zone setup. By default the MultiPhone tries to retrieve time information from Internet time servers. In case you do not have an Internet access right now you may use **Advanced Options** button and configure the time and date manually.

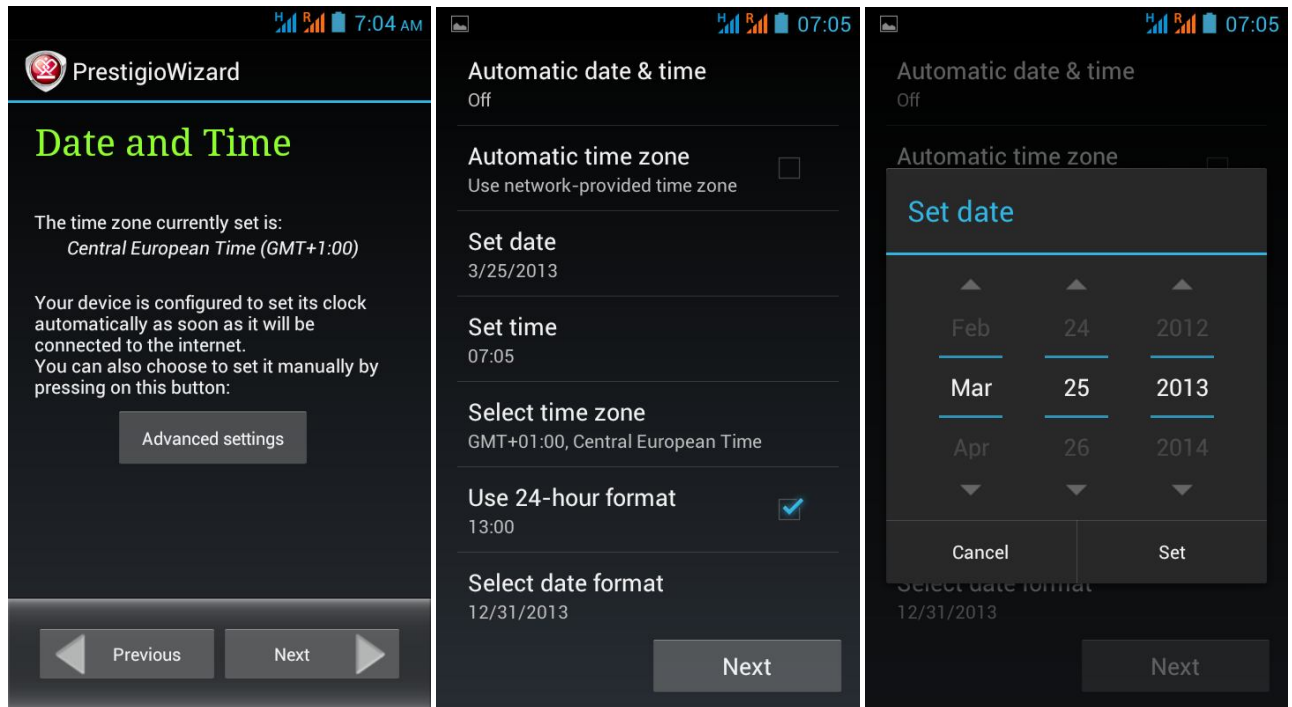

Tap **Next** button to continue to WiFi connection screen.

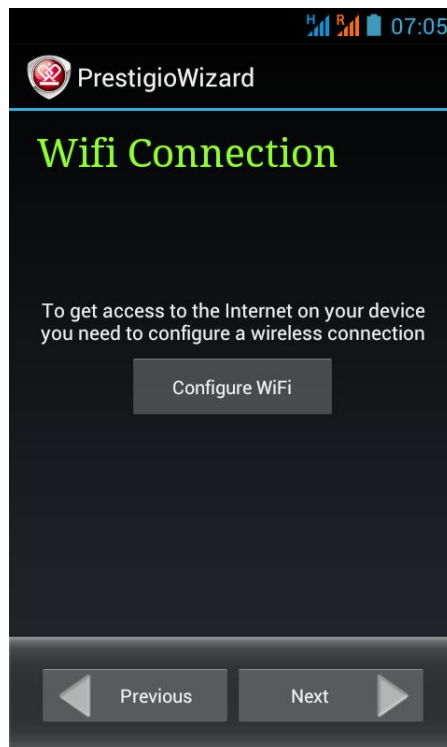

To connect to a Wi-Fi network, you should tap button **Configure WiFi**, choose your network SSID name in a list, enter the password in pop-up menu and press **Connect**:

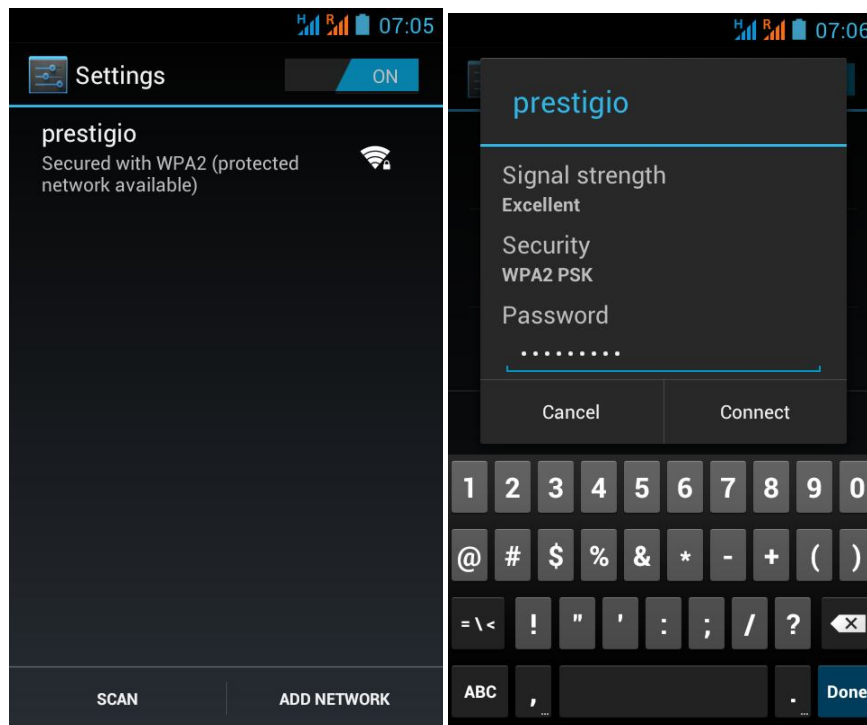

[NOTE] You may check the **Show Password** option in order to make it visible, but please consider the possible risks.

After successful connection, the Wi-Fi connected icon  will appear on the status bar.

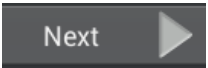
Tap Back button and  to continue.

Third party applications screen allows the customer to install the pack of programs which enhance MultiPhone's functionality.

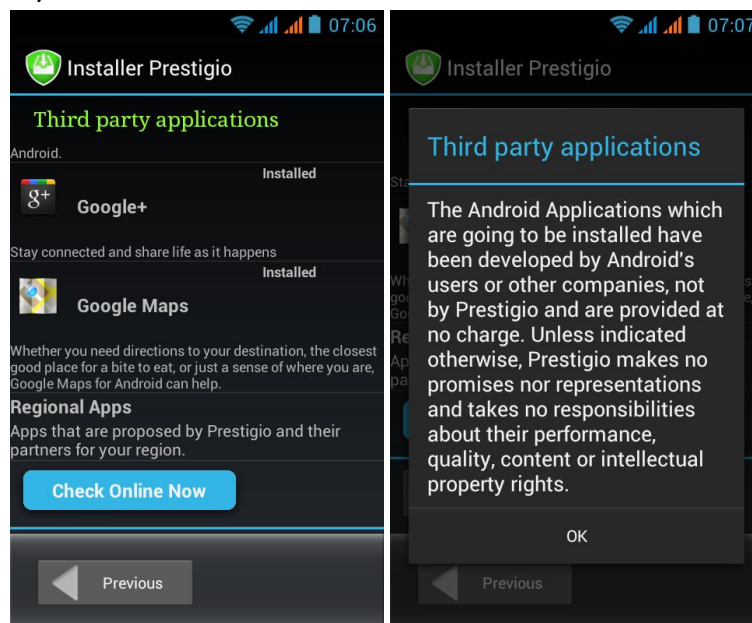

Installer Prestigio utility has the extended functionality comparing the default Third party application utility. It provides user with the better tools for management of pre-loaded applications and games. **Installer Prestigio** scans the MultiPhone for installation files pre-loaded at factory, displaying the found application in a list. In addition, it offers the customer to check online Prestigio repository for

applications and games for this particular model and region. Tap **Check Online Now** button to use this option. Application name, as well as its brief description and size will be displayed in the list. You may check the desired ones and tap **Download and Install** button. After you accept the Legal disclaimer the installation starts.

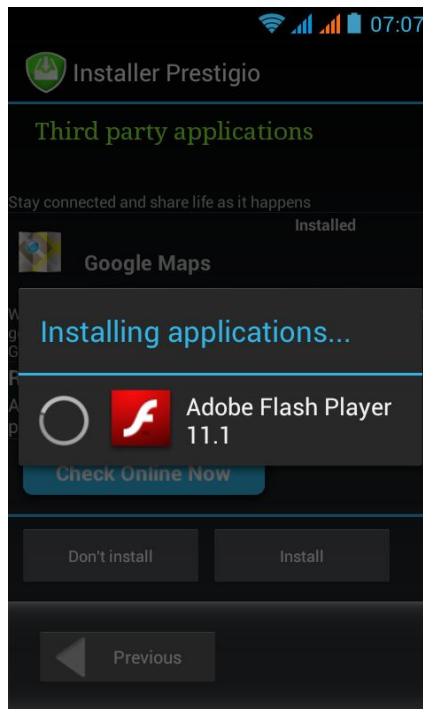

After the installation finish successfully, Wizard will automatically continue to the Final screen. The final wizard screen will appear upon the installation of the third party applications

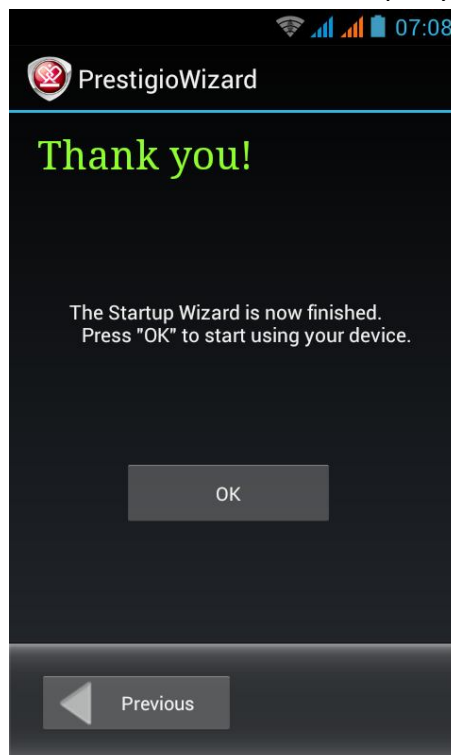

Now you can tap **OK** button and start using your MultiPhone. Hope you will enjoy this experience. Thank you!

3. Home Screen

3

The Home screen is your starting point to access all the features on your device. It displays application icons, widgets, shortcuts, and other features. You can customize the Home screen with different wallpaper & widgets and display items you want. See the **Personalizing** section in this manual. When you start, the Home screen appears.



Sleep mode

Sleep mode suspends your device to a low power state while the display is off in order to save battery power. You will still be able to receive messages while the device is in Sleep mode.





[Note]: By default the device enters sleep mode automatically in case it's not operated for 2 minutes. You may change this time or even disable automatic sleep mode activation in menu **Settings-Device-Display-Sleep**.

Wake up from sleep mode

To wake up your device manually, press the Power Button. You will see a Lock Screen than.

Unlocking the screen

Touch the lock icon , hold it and slide towards.

Please note, that depending on the direction you move the unlock icon, you may just unlock the MultiPhone  and enter Home screen, or start the Camera application , launch Phone  application or enter Messaging  app.

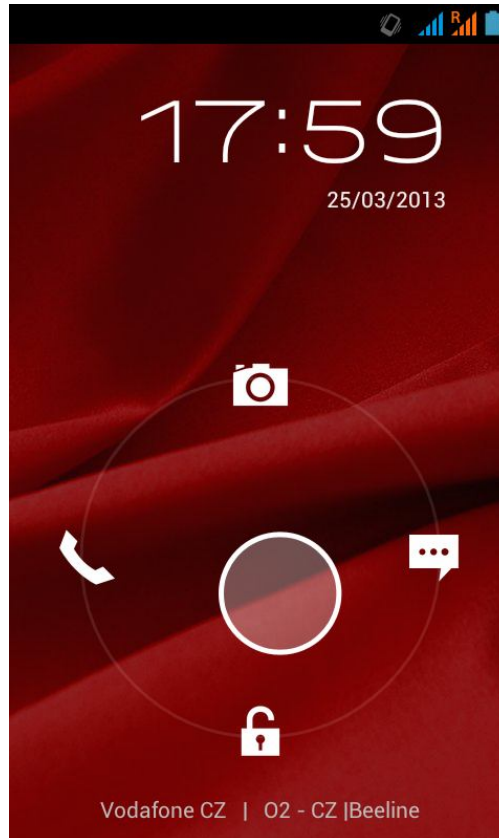

Other unlock ways, like PIN code, Face Unlock, Pattern etc. could be set up by user in menu **Settings-Personal-Security-Screen Security – Screen Unlock**.















Browse Home Screen

You can go to the extended Home screen by sliding your finger horizontally across the screen to go to the left or right side of the Home screen. Tap the icon  to view all applications on your device.

3.1 Status and notifications

Status and Notification Icons may appear.

The status bar contains different information like time and date, battery status, wireless networks status, active notifications from Android OS or installed applications and so on. When an application is running, corresponding notification icon will appear in the notification area. Icons you may often see are listed as follows:

Status icons and its meanings	
	Tap to go to the Home screen
	Back
	Recently applications view
	Menu icon
	Android debug bridge enabled
	Connected to a Wi-Fi network and display the signal strength
	Battery status
Notification icons meanings	
	New Gmail (Google Mail) message
	New Email message
	Music player is ongoing
	SD card is mounted
	USB Connected
	Airplane mode
	Settings

Notification panel

Notifications alert you to the arrival of new messages, calendar events, and alarms, as well as other events, like downloads.

When a notification arrives, its icon appears at the top of the screen. Icons for pending notifications appear on the left, and system icons showing things like Wi-Fi signal or battery strength on the right

If a new notification icon displays in the status bar, touch and hold the status bar, then slide your finger upwards to open the Notifications panel as follows:

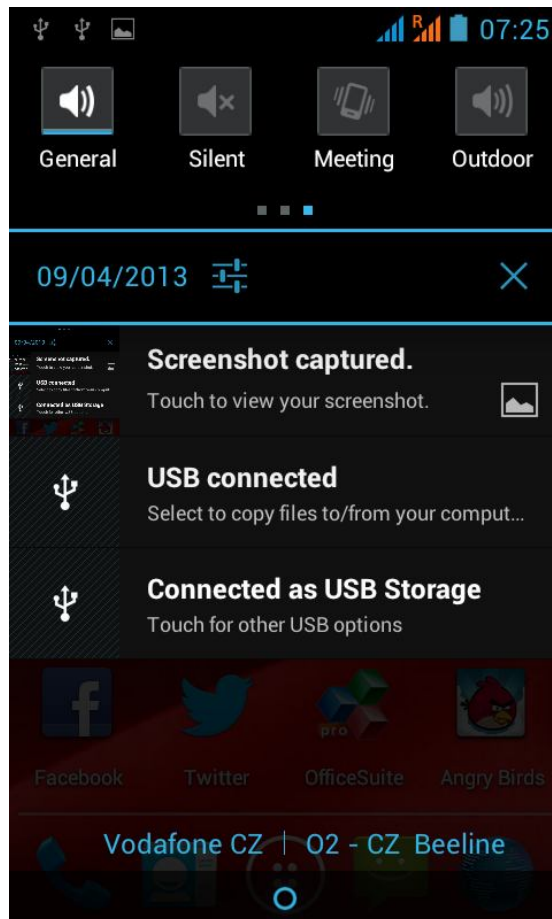

If you have several notifications, you can scroll down the screen to view more notifications. Certain notifications can be expanded to show more information, such as email previews or calendar events. The one at the top is always expanded when possible. To open the related app, touch the notification icon on the left. Some notifications also allow you to take specific actions by touching icons within the notification. For example, Calendar notifications allow you to Snooze (remind you later) or send email to other guests.

When you're finished with a notification, just swipe it away.

Simply touch the Back button or slide the Notification panel up to close it.

Quick Settings

Quick settings menu is placed on the top of notification panel. It provides the user with the convenient way to change the most frequently used settings of the smartphone. To open Quick Settings, swipe down from the top edge of any screen, you may navigate all three tabs by sliding them right and left.

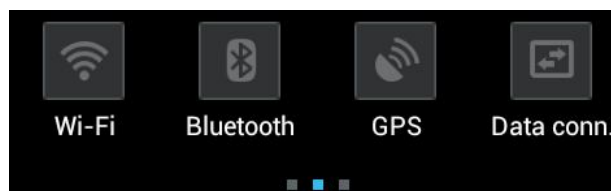

The default (middle) tab contains on/off switches for WiFi, BlueTooth connection, GPS sensor and Data connection button, which allows you to turn instant data connection off, turn it on – and choose the SIM card which supposed to be used for this.

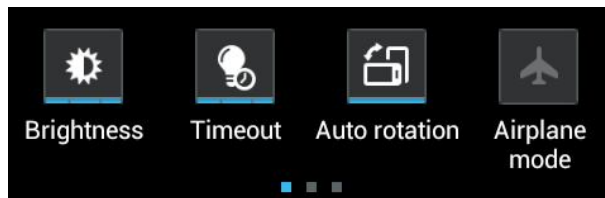

The left tab contains the following controls:

The Brightness switch, which toggles the Brightness modes

Timeout button – allows you to setup the display backlight timeout

Auto rotation switch – turns on/off the rotation sensor

Airplane mode – turns on/off the Airplane mode (all the data connection interfaces are disabled)

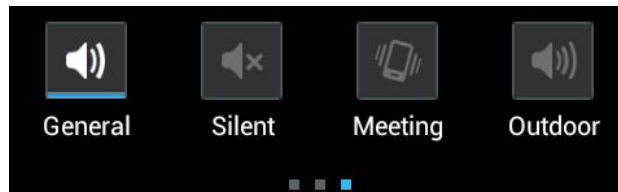

The right tab is used for default profiles settings and contains buttons for General, Silent, Meeting and Outdoor profiles.

3.2 Shortcuts to Add widgets

Widgets put at-a-glance important information and media content up front on your Home screen. Some widgets are already added to your Home screen for your convenience. You can add more from the available selection of widgets, or download more widgets.

Adding a widget to your Home screen

To add widgets to Home screen, you can:

- Tap  on the home screen to enter into all apps interface as follows



- Tap **WIDGETS**

- Select one item. Touch and hold your finger on widget. Choose desired place for widget on the home screen.

[Note]: When choosing place for widget you can switch home screen tabs by sliding finger with holding widget to the left or right side of the home screen.

Examples of Widgets are as follows:

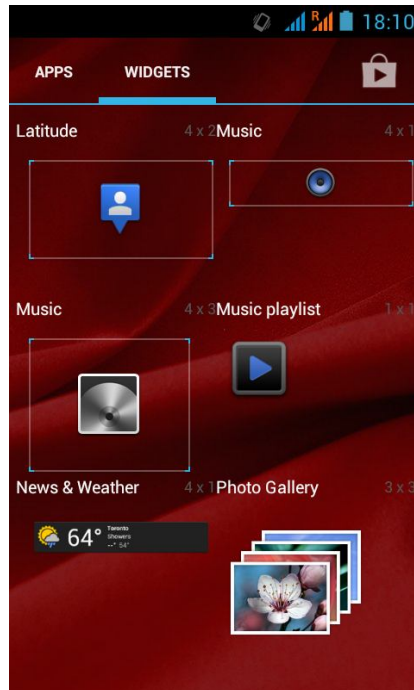

Removing widget from your Home screen

To remove a widget, touch and hold the widget until the icon “X Remove” or “X” appears at the top of the screen, drag the widget onto it, so the widget you want to remove has become red and release your finger.

3.3 Finger gestures

Tap: When you want to type using the keyboard, select items onscreen such as application and settings icons, or touch onscreen buttons, simply tap them with your finger.

Touch and hold: To open the available option for an item (e.g. contact or link in a web page), simply touch and hold the item.

Swipe or slide: To swipe or slide means to drag your finger vertically or horizontally across the screen.

Drag: Touch the object before you start to drag. While dragging, do not release your finger until you have reached the target position.

Rotate: For most screens, you can automatically change the screen orientation from portrait to

landscape by turning the device sideways. When entering text, you can turn the device sideways to bring up a bigger keyboard. Refer to Settings chapter for more details.

3.4 Coping files to and from the storage card

You can copy music, photos/pictures and others to MultiPhone to personalize your device.

1. Use the USB cable that came with your device to connect it to an USB port on your computer.
2. When the icon  appears in the notification area, open the notification panel and tap **USB Connected** to open the following screen:

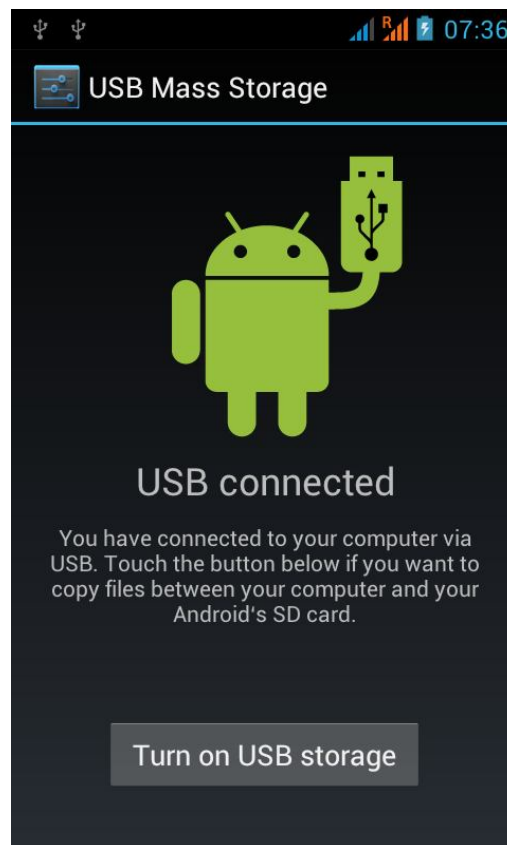

3. Tap **Turn on USB storage**, read pop-up notice, tap “OK” and when the notification icon  turns yellow, the computer will recognize your device as a removable disk;
4. Find the removable disk and open it. Do one of the followings:
 - Copy the files from the computer to the storage card’s root folder.
 - Copy the files from the storage card to a folder in your computer or computer desktop.
4. After copying the files, you may turn USB off. To do this, if you would like to keep your device connected to the computer and enable reading its storage card from Android, you can open the Notifications panel and tap **Turn off USB storage**. Otherwise, if you would like to disconnect the device physically from computer, please unmount the removable disk (that is, your device) as required by your computer’s operating system to safely remove your device.
5. Disconnect your device from the computer.

3.5 Searching the device and the web

You can search information in your device and in the Web by using the Quick Search Box. It's placed on the top side of the Home Screen:



Tap the Google box, and enter the search item into the Quick Search box.

You may use also the following way:



1. Touch  on the home screen to enter into all apps interface;
2. Tap **Search** and then enter the search item in the Quick Search Box

As you type, matching items on your device and suggestions from Google web search are shown as a list. The suggested items that appear will depend on the options that you have selected in the search settings.

3. Make one of the following:

- If what you're searching for is in the list of suggestions, tap it in the list. The item opens in the appropriate application.
- If what you're searching for is not in the list, tap Menu button to open the search settings menu. Tap Web and then tap Back and Enter to search the Web. The web browser opens, displaying results of a Google search on the Web.

4. Personalizing

4

4.1 Change your wallpaper

Personalizing your Home screen wallpaper with your favorite photo is a quick and easy way to change the feel of your device and give it a fresh look. Browse the collection of wallpapers included in your device or choose from photos that you have taken with the camera.

To change your Home screen or lock screen wallpaper:

1. Touch and hold your finger at the free area of the Home screen. Choose wallpaper from menu that appears.



[Note]: You can also tap  >Settings>Display>Wallpaper to reach Choose wallpaper from menu.

2. Choose source and wallpaper you would like to use.

You can do one of the following:

- Tap **Gallery** to select a photo/picture that you have taken using the camera or copied to your storage card. Tap **Crop** to crop the photo/picture and set the cropped picture as wallpaper.
- Tap **Wallpaper** gallery to choose from preset wallpapers and then tap **Set wallpaper**.
- Tap **Live Wallpaper** gallery to choose from preset live wallpapers and then tap **Set wallpaper**.

4.2 Personalize your Home screen with folders

Use folders to group related applications and other shortcuts to keep your Home screen tidy and organized.

Adding folders on your Home screen

Touch and hold the application shortcut and drag it onto another shortcut to create a folder for the applications you want to file together, and then release your finger to finish creating a folder. You can drag any other application shortcut into the new folder.

To rename a folder:

1. Tap the folder to open it.
2. Tap **Unnamed Folder** to prompt the keyboard.
3. Enter a new folder name and then tap Enter key.

Removing folders from Your Home screen

Tap the folder you want to remove to open it. One by one touch and hold application shortcut inside folder and drag it out of the folder. When only one application shortcut will stay inside the folder, folder will be automatically deleted.

[Note]: During operations with folders your application shortcuts are not removed.

4.3 Rearrange widgets and shortcuts on your Home screen

Rearrange widgets and shortcuts on your Home screen to get space for adding more items to the Home screen.

Moving a widget or shortcut

1. Gently tap and hold the widget or shortcut you want to move.
You'll see a blue edging around the widget or shortcut. Don't release your finger.
2. Drag the widget or shortcut to a new location on the screen.
Pause at the left or right edge of the screen to drag the widget or shortcut onto another Home screen panel.
3. When the widget or shortcut is where you want it, release your finger.
If you've released your finger but a message shows that there's no space to place the widget or shortcut, drag it right or left again to another Home screen panel.

Removing shortcuts

To remove a shortcut, touch and hold the shortcut until the icon "X Remove" or "X" appears at the top of the screen, drag the shortcut onto it so the shortcut you want to remove has become red and release your finger.

5. Communication

5

5.1 Contacts

Contacts give you quick and easy access to the people you want to reach. When you first time turn on your phone and sign into your Google Account, any existing Google contacts are downloaded to your phone. After that, your contacts are synchronized: any changes you make to your contacts on the phone or the web are made in both places the next time you sync. Contacts from Exchange ActiveSync accounts are also synced in this way. Information about your contacts is shared with other applications, such a Gmail, Google Talk, Messaging, Gallery (for sharing photos and videos) and so on. If you have more than one account with contact information, Contacts joins duplicates into a single entry. You can also manage that process manually.

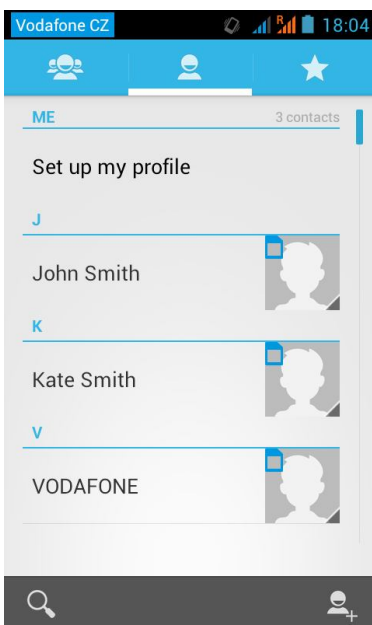

Touch the People  icon on the Home screen or in the Application screen. All of your contacts are displayed alphabetically in a scrolling list.

You can drag the list up or down to scroll it or slide your finger up or down to scroll quickly.

You can search for a contact by name. To search for a contact tap the

Search  icon and start entering the name of the contact you're searching for. As you type contacts with matching names appear below the search box.

To **Add a new contact** open your People apps (a list of contacts), tap Add new icon () , choose the location where the contact supposed to be stored at (one of SIM cards, phone memory or Google Account), and fill the necessary details of the contact: mobile and landline phone numbers, e-mail, address, company/organization etc.

You may add additional fields, such as Notes, Nickname, Instant Messenger account info, web-site etc, by pressing Add additional Field button in the end of the list. Or, vice versa, leave some fields blank at your discretion.

Press Done  when ready to save the created contact and exit editing mode.

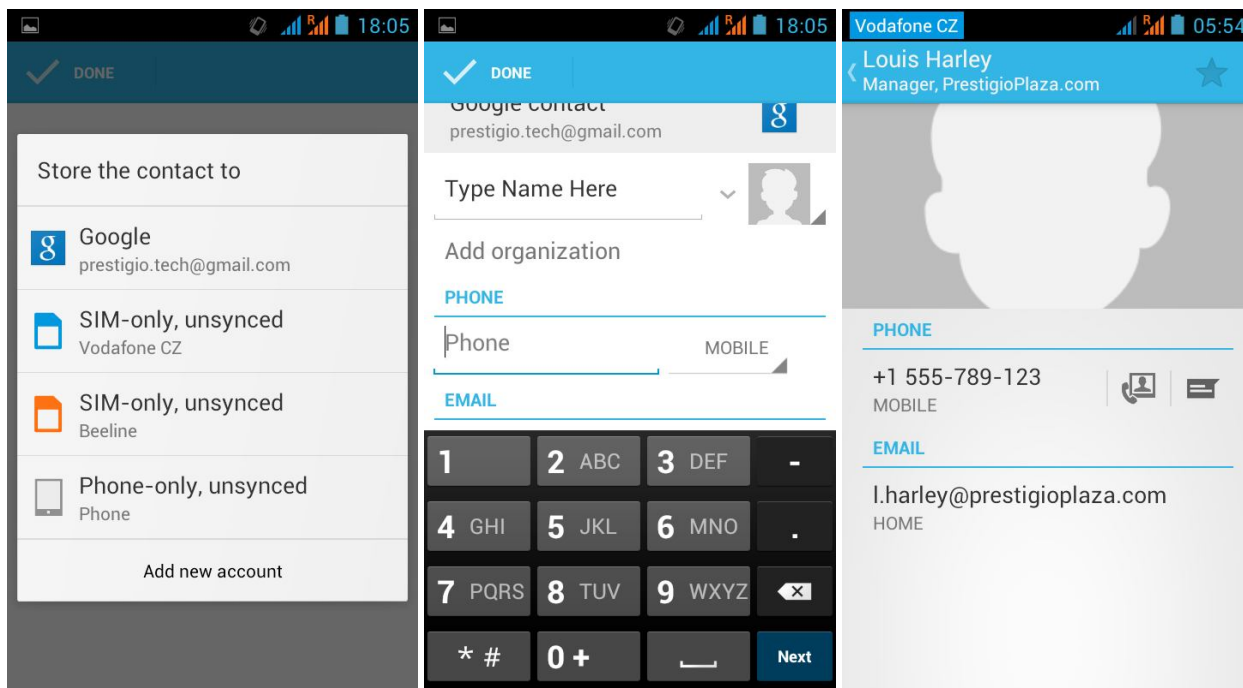

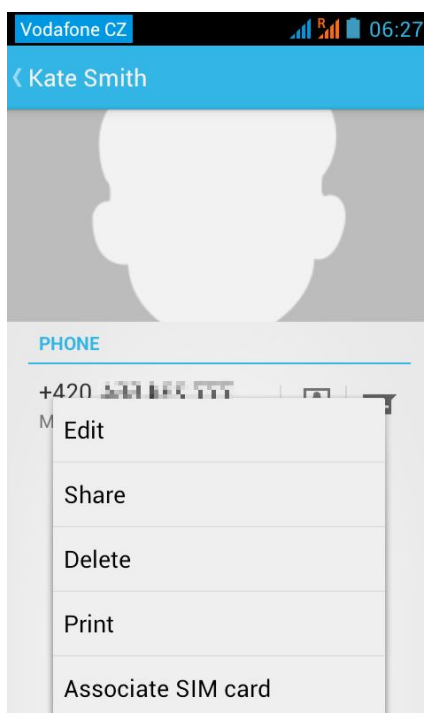

You may anytime Edit, Share, Delete, Print the contact or change its association with respective SIM card by tapping Menu button of your smartphone. Open the People apps, tap the contact you'd like to edit, tap the Menu button and select desired action in the list:

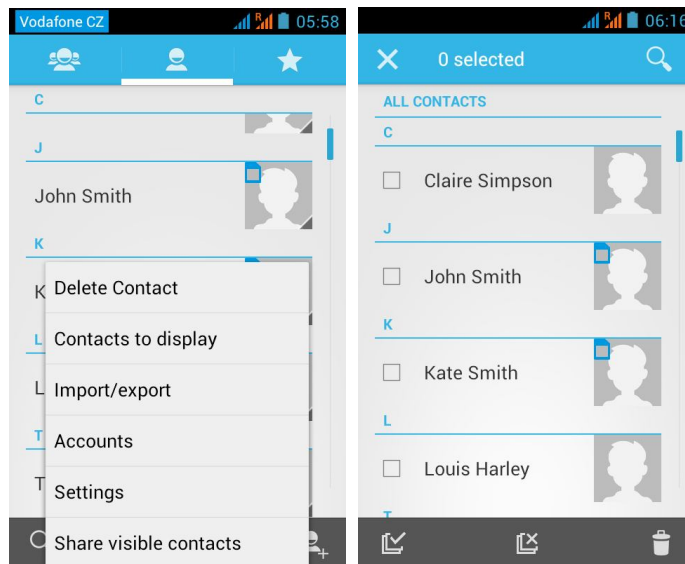

To **Delete a contact** open People apps, tap the options button of the smartphone, and choose Delete contact in the list of options.



You will be able to select the contacts you'd like to delete by using the checkboxes. Please note, that system allows you to make multiple selections. Use icons  and  to Check All and Uncheck All contact respectively. Tap Delete  icon when ready.

If you'd like to Share contact and had chosen the respective option the following list will appear to offer to choose the way you'd like to use for sharing:

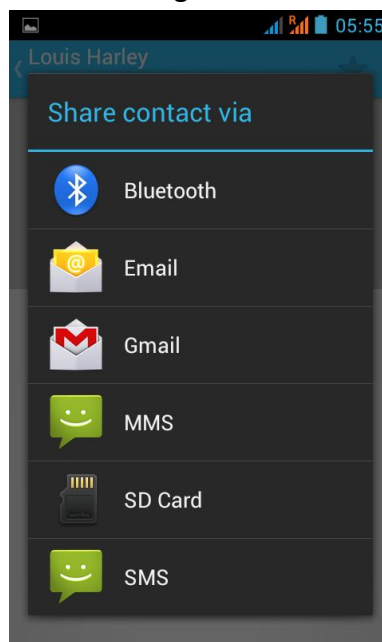

5.2 Making a phone call

You can place calls from the Phone app, the People app, or other apps or widgets that display contact information. Wherever you see a phone number, you can usually touch it to dial.

To dial using the Phone app:

1. Touch the Phone  icon on a Home or All Apps screen.

Notice the three tabs at the top of the phone: Dialer, Recent Calls log and Contacts. You can make calls from any of them.

The Dialer tab lets you dial manually. Touch the keys to enter the number, then touch the Phone icon below the keypad to dial.

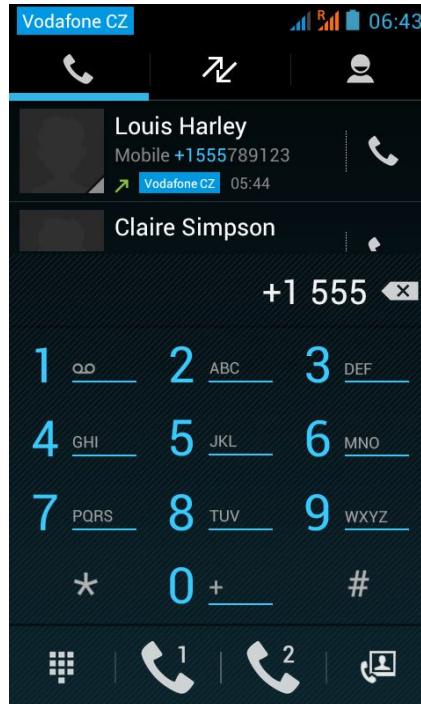

If you had entered a wrong number and would like to correct it, please touch  to erase digits one by one.

You may use SIM1  or SIM2  for making a call when correct number is entered.

You can switch applications during a call – for example, to look up information by using Chrome. To dial an international number, touch & hold the 0 key to enter the plus (+) symbol. Then enter the international prefix for the country, followed by the full phone number.

The Call log  tab shows recent calls. Touch a call to return it.

The Contacts  tab shows the numbers you frequently call at the top, and all your contacts below. Touch to dial.

You can switch applications during a call – for example, to look up information by using Chrome. To return to the Phone app while a call is in progress:

1. Swipe down from the top of the screen to reveal your notifications.
2. Touch the green phone icon.

To end a call in progress, touch the End Call  icon at the bottom of the screen.

Answer or divert calls

When you receive a phone call, the Incoming Call screen opens, displaying the caller ID and any additional information about the caller that you've entered in People apps. In case the number is not in the list of your contacts you will see only phone number.

All incoming calls are recorded in the Phone app's Call log tab. If you miss a call, you receive a notification. To silence the ringer before answering the call, press the Volume Down button on the side of your phone.

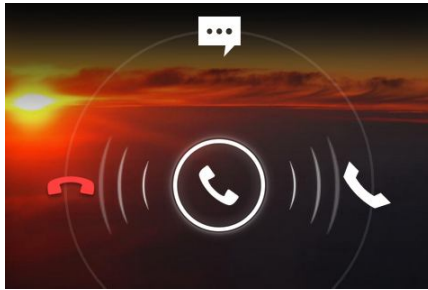

When a call arrives, touch the white phone icon and slide over one of these icons:



Answer call - Start talking to the caller.



Reject call/Send to voicemail - Directs the caller to leave a voice mail message



Send a message - Opens a list of quick text responses. Touch one to send it to the caller immediately.

Note: To edit text responses from within the Phone app, touch **Menu button > Settings > Other Settings > Quick responses**

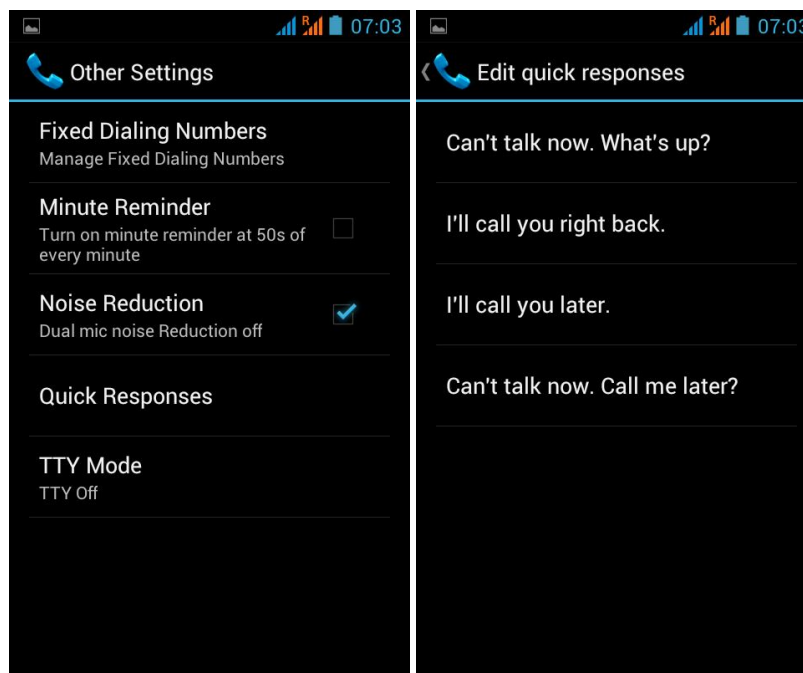

Work with the Call log

The Call log is a list of all the calls you've placed, received, or missed. It provides a convenient way to redial a number, return a call, or add a number to your Contacts.

Within the Phone app, the Call log is under the middle tab. Touch a number for more information about the call, or touch the phone icon beside it to call back. Arrow icons beside a call indicate the type of call.

These arrows indicate types of calls:



- Missed incoming call







- Received incoming call

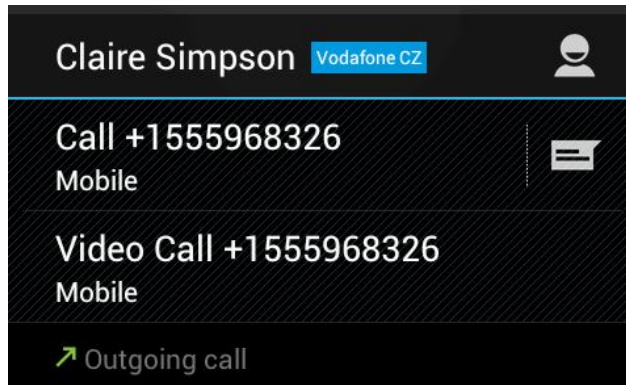

- Outgoing call

While viewing details for a call:



- Touch the number to call it.
- Touch  to send a text message.
- Touch the Contacts  icon to view contact details
- Touch  to add a new People card for the caller (if the number is not found among your contacts).

To clear the Call log touch the Menu button and choose Delete.

Options during a call

During a call, you can:

Answer another incoming call. You see the Incoming Call screen, displaying the caller ID and any additional information about the caller that you've entered in People. As with any incoming call, touch the white phone icon and slide to answer, respond with a text message, or send the call to voicemail. If you answer, the first call will be put on hold. If you respond with a message or send to voicemail, you return to the first call.

Adjust the volume: Use the volume buttons on the side of the phone.

During a call, you can also use buttons near the bottom of the screen to:



Switch to the dialer, for example to enter a code.



Controls the audio output as follows:

- If a Bluetooth headset is not connected: Turns the speaker phone on or off.
- If a Bluetooth headset is connected: Functions as a 3-way switch between the built-in earpiece, the speakerphone, and the headset. The icon changes to indicate the current output. Touch & hold to see a 3-way menu.
- If a wired headset is plugged into the phone, it replaces the phone's built-in earpiece.



Mute your microphone.



Put the other party on hold



Make another call separately from the first call, which is put on hold.

5.3 Messaging

You can use Messaging to exchange text messages (SMS) and multimedia messages (MMS) with your Contacts.

To open Messaging app you may either tap respective icon on the Home Screen, Apps list, Contact card, or swipe the unlocking circle to messaging pictogram (see the respective screens and icons below)

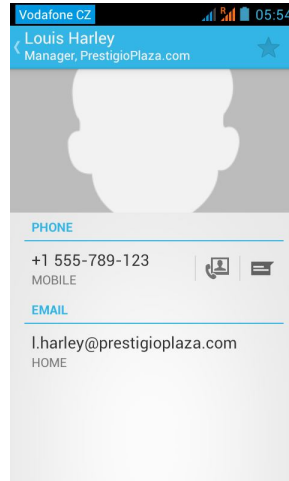

The Messaging window opens, where you can create a new message or open an existing conversation.

Touch New message  to start a new text or multimedia message/conversation.

Touch an existing message thread to open it.

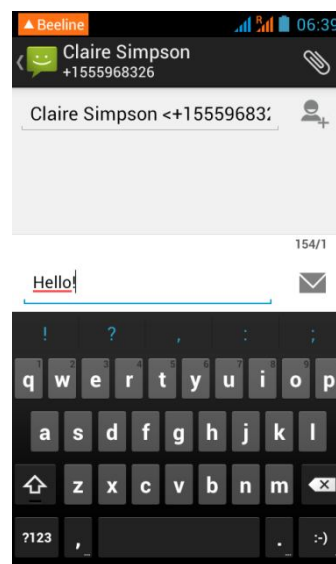
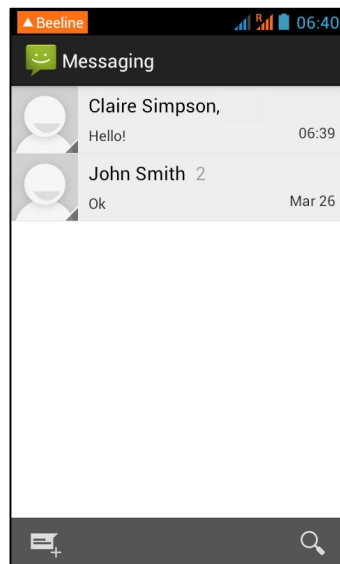

Type a phone number in the “To” field or choose the contact from People app by tapping the contact  icon. You may choose several recipients for your message. As you enter the phone number, matching contacts appear. You can touch a suggested recipient or continue entering the phone

number. You can also enter the name of a contact with a mobile number.

Touch the composition text box to start entering your message. You can send text (SMS) messages of up to 160 characters to another mobile phone. If you keep typing after the limit, your message is delivered as a series of messages (if supported by your carrier). As you write the message, a counter

appears above the “Send”  button to tell you how many characters are left to reach the 160 character limit along with how many parts the message will be split into.

If you go over that limit, a new message is created, which is joined with its predecessors when received.

Multimedia (MMS) messages can contain text and a picture, a recorded voice, an audio file, a video, or a picture slideshow. Messaging automatically converts a message into a multimedia message if you send it to an email address instead of a phone number, add a subject or attach a media file.

To insert a smiley, press Menu button and then touch Insert smiley to open a scrolling list of smileys.

If you press **Back** while composing a message, it’s saved as a draft in your Messaging window. You can easily recognize the Drafted messages as they’re marked with red word **Draft** in a list of conversation (see below).

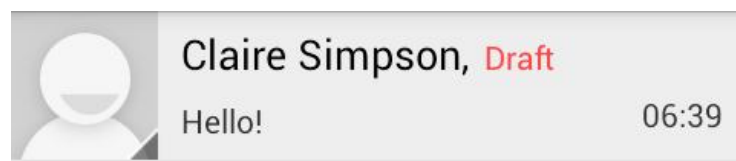

Touch the message to resume composing it.

Tap Send  icon to send a complete message.

You may perform the following actions if you tap and hold the message in a conversation:

- Copy text – to copy complete text of the message to the memory buffer for further use

- Save message to SIM card – transfer the message from smartphone memory to the SIM card memory (if supported by your SIM card)

- Forward – forward the message to another contact at your choice

- Lock/Unlock - You can lock a message so it won’t be deleted if you reach your storage limits (see Storage settings). A lock icon appears to the right of the message. Unlock a message by touching & holding it and then touching Unlock message. If you try to delete a thread that contains a locked message, you’re asked to confirm that you want to delete it..

- View details – shows message type, contact info and sent date/time information.

- Delete – this option deletes the selected messages.

Messaging settings

Enter **Messaging** apps and tap **Menu** button of your smartphone, than choose **Settings** to configure messaging settings. You may change the following:

- Storage settings** - Check to **Delete old messages** in a thread when the Text message limit is reached. Uncheck to keep all messages. You may Set both the **Text** and **Multimedia message limit** per conversation. When the limit is reached, older messages are deleted.

- Text message (SMS) settings** allow you to setup receipt of delivery reports for the messages you send, manage SIM card messages (the ones saved to SIM card), Edit quick text templates, setup SMS service center and change default SMS storage location.

Multimedia message (MMS) settings allow you to setup request of both delivery and read reports for the multimedia messages you send, send the read report for MMS you receive, setup Auto-retrieval both for home network and roaming, change the message creation mode, limit the size of MMS and set its default priority.

6. Web browsing

6

User can connect to the network via the browser.



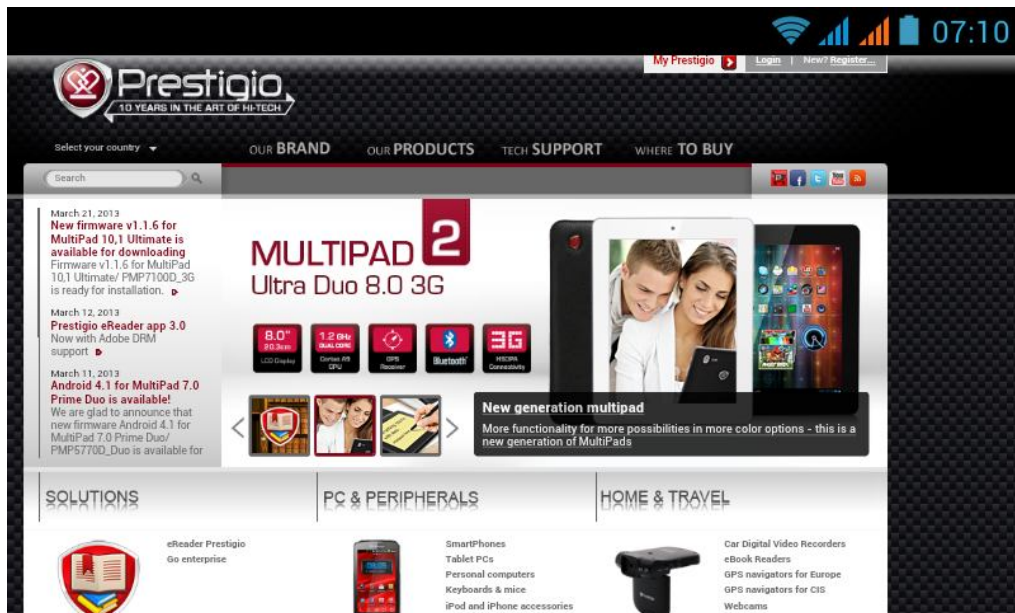

Tap the browser icon on the Home screen to open it as follows:





Use keyboard to type URL (web-site address) or search phrase at the address bar.

Please note, that the browser supports tabs, you may open multiple tabs in a single browser window, switch them by a single touch or close the tabs at your choice.

Touch  to open a new tab.

Touch  to close the tab.

 this icon allows you to reload the active page.



To exit browser application just tap Back button .

7. Manage Applications

7

You can personalize MultiPhone and enrich your experience with it by installing a wide variety of free and paid apps ranging from productivity apps, entertainment, to games. When you find a program you want, you can easily download and install it on your MultiPhone with just a few steps as follows:

How to install Android programs

1. Tap  at the Home screen to enter into all apps interface. Run **Play Store** application .
2. During first launch Play Store will request you to login or register a new account. Enter your E-mail and password if you have a Google account already. Otherwise tap Create account and follow the instructions.
3. After signing in you will be able to search, download and install applications from Play Store. Some applications are free, while other might charge you through credit card.
4. Use Play Store interface to install program to your device.

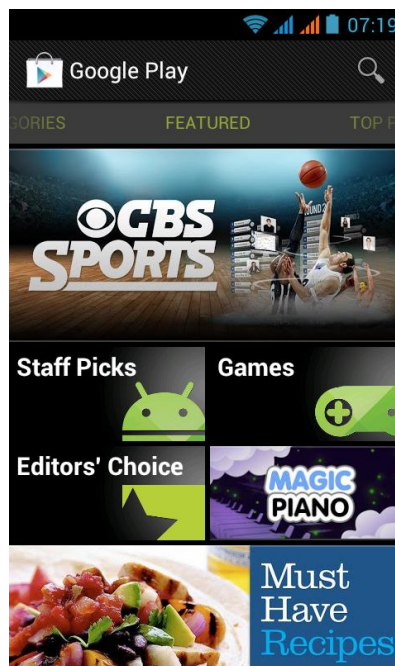

How to uninstall Android programs

To uninstall the program:

1. Go to **Settings > Apps > Downloaded** menu
2. Tap on program you want to uninstall
3. Tap **Uninstall** and **OK** in popup menu.

[Note]: You can also use an alternative way of uninstallation: enter the list of applications, tap the application you'd like to uninstall, hold it and drag to the "Uninstall" icon on top of the display.

8. Typical applications



8.1 Music Player

Enjoy listening to songs and music on your MultiPhone using the Music application. You need to copy music files to your storage card first to use the Music application to play music. To find out how to copy files, see **“Copying files to and from the storage card”**. Supported audio formats see in MultiPhone technical specifications above.





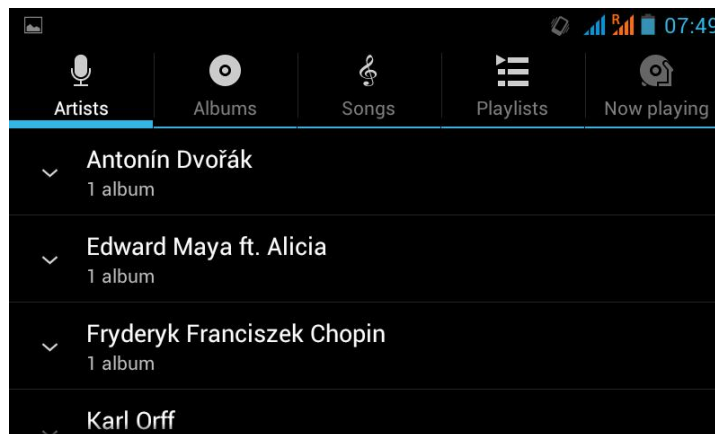



Tap the icon  in an Apps list to enter the following screen:



Your music is organized into different categories such as Artists, Songs and Albums. Tap one of the category tabs to view a category.

Select a song in the playlist and tap on it to start playing as follows:

	Tap to go to the previous song.
	Tap to play, pause, or resume playing the song
	Tap to go to the next song
	Tap to go to the now playing list
	Tap to switch the following repeat modes: repeat all songs, repeat current song, do not repeat
	Tap to shuffle the current playlist.

When you are playing music and the screen turns off, you can control the music playback volume with hardware buttons Vol+ \ Vol-.

8.2 Video Player



Tap the launcher icon on the Home screen and then tap the Video player icon to go to the following interface:

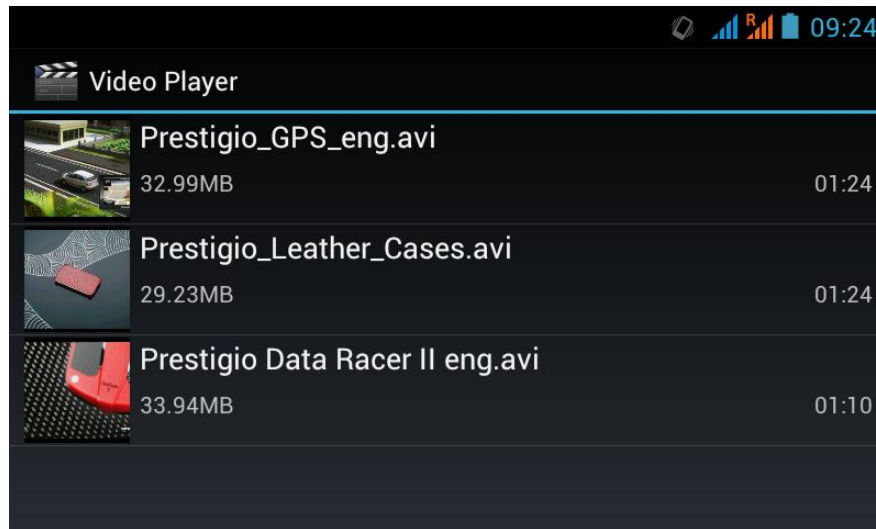

Open the Video folder and tap on a video file to start playing it.

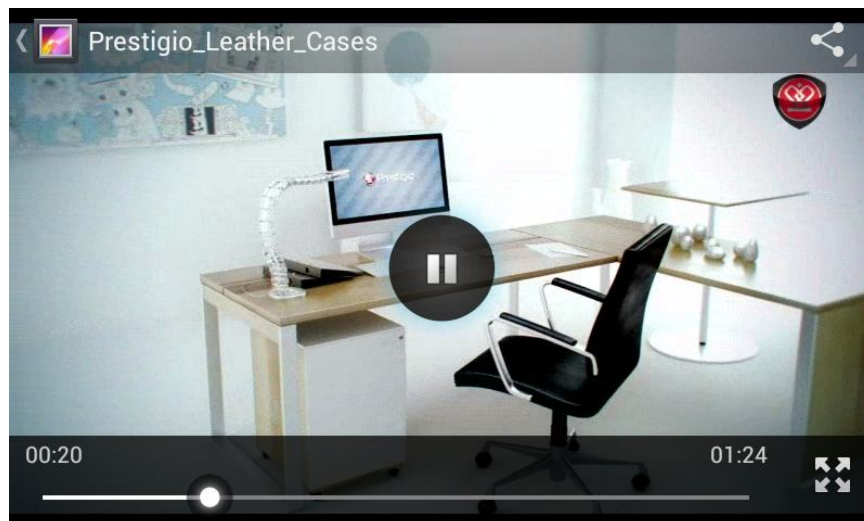

Move the pointer to scroll the video forward or back.



Tap to open the full-screen mode of the player



Tap share to share the video file via Google+, BlueTooth or send it as a multimedia message

To quit the video playing screen, touch the Back button of the smartphone.

8.3 Gallery

You use Gallery to view pictures and play videos that you've taken with Camera, downloaded, or copied onto your SD card. You can perform basic editing tasks on pictures and set them as your wallpaper or contact picture. You can also share your pictures and videos with friends.

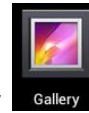

On the Home screen tap the launcher icon and Gallery icon after. Photos and videos are classified automatically for easy view. The gallery application will run and the interface is as follows:

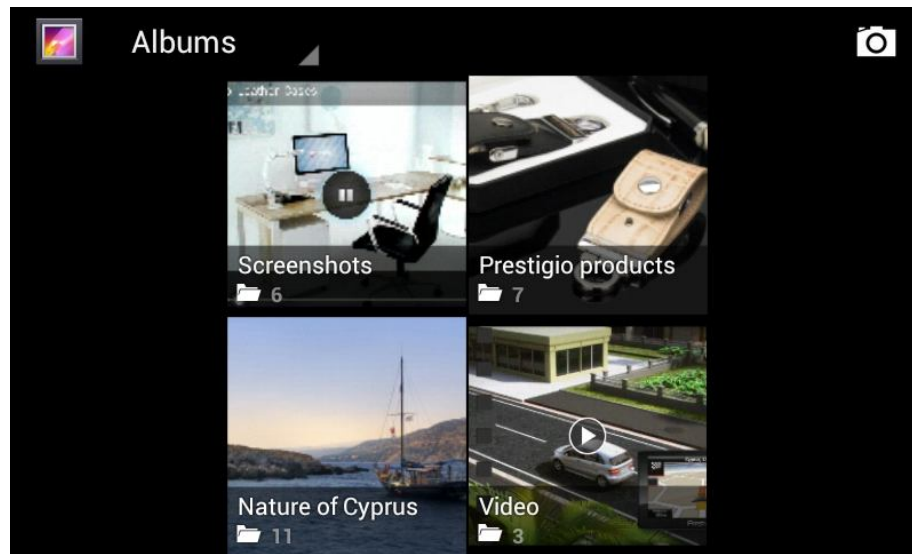

Browse & edit pictures/photos

Tap an album to open it and view its contents;

- this icon could be found on upper right corner of the screen; it allows you to browse all photos/pictures in slideshow mode.

Select a picture to view it in full screen mode; drag left or right to view the next or previous picture in the album; move your fingers inward/outward to zoom out/zoom in the selected photo/picture.

- this button allows you to share it with friends via email, Twitter, Facebook etc.

Use delete icon to delete the selected files.

Tap Menu button to pop-up the following control menu:

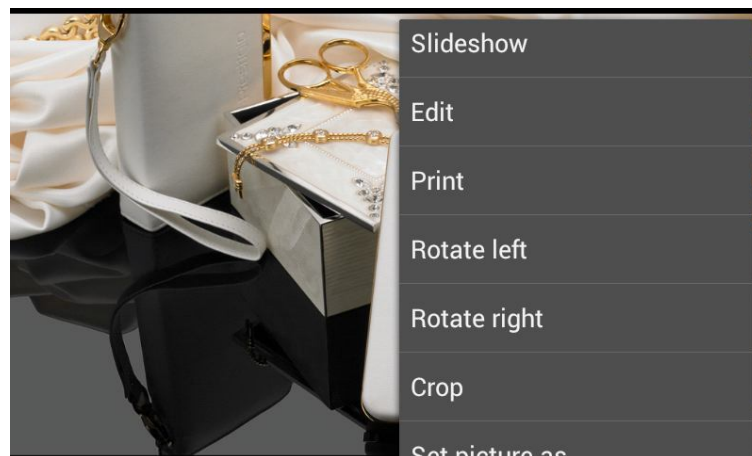

Slideshow - starts a slide show of all pictures in the album;

Edit - to edit the selected picture. When the picture is zoomed in, drag the picture to view parts that are

not in view. When the picture is zoomed to fit the window, drag left or right to view the next or previous picture in the album.

Rotate left or **Rotate right** to rotate the picture/photo 90° anticlockwise or clockwise; If you tap **Crop** icon the following cropping rectangle will appear on top of the picture/photo.

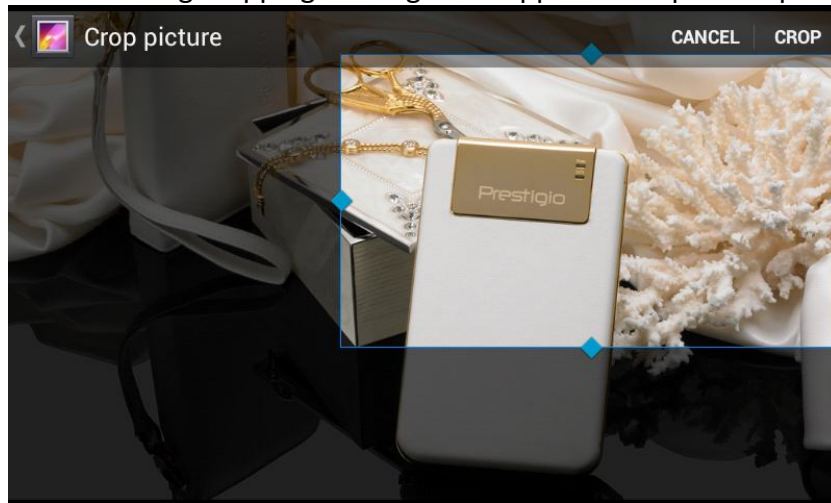

Drag from the inside of the cropping tool to move it; drag an edge of the cropping tool to resize it to any proportion; drag a corner of the cropping tool to resize it with a fixed proportions.

Tap **CROP** to save a copy of the picture as you cropped it. The original (not cropped) version remains on your SD card.

Set picture as to set the current picture/photo as wallpaper;

Details to see more details about the current picture/photo;

8.4 File Manager



On the Home screen, tap the File Manager icon to open it as follows:

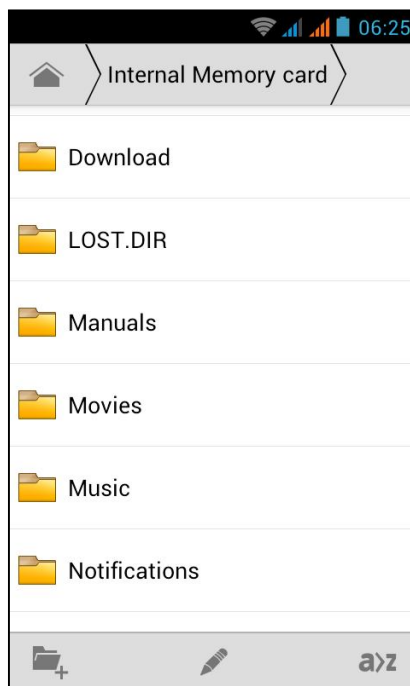

In File manager you can navigate your storage and manage your files in the local disk and your storage card: copy/paste, delete, move and rename file and folder and send them via Bluetooth, mail or Skype.

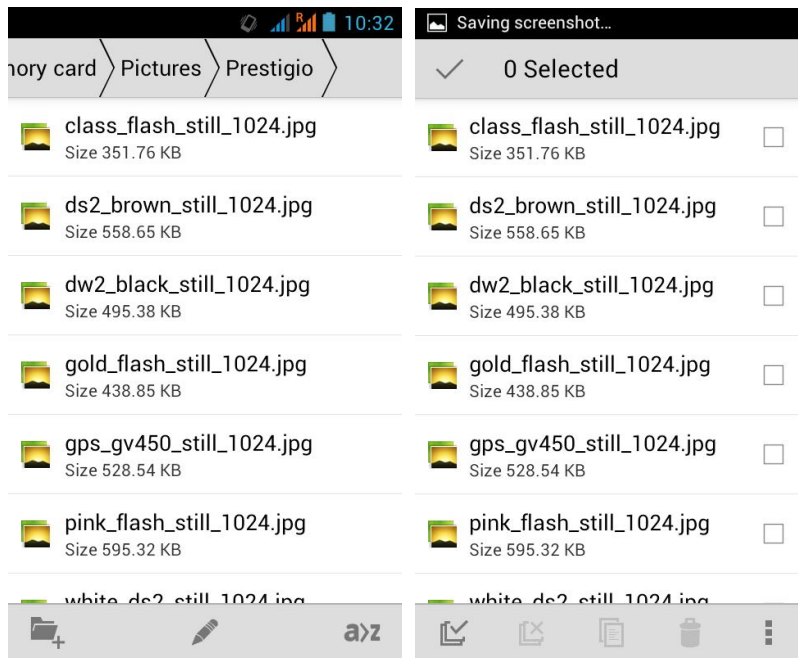



Touch  to select multiple items in the list.

8.5 Instant Messaging tools

You can download from Google Play and install chat tools on your device such as Skype, Fring, ICQ etc. Please refer to Messaging chapter of this manual to get information about SMS/MMS messaging features of the smartphone.



8.6 Emails

Tap the launcher icon  on the Home screen to display all icons, tap the Email  icon to run it. With help of Prestigio MultiPhone you can:

1. Setup mail accounts
2. Create new mails
3. Receive and send mails
4. Download or open the attached files

8.7 Camera

The Camera app is a combination of a camera and camcorder. You may toggle between these two modes

by touching respective icons  and .

To take pictures and videos touch the Camera icon  on a Home or All Apps screen.

9. Prestigio preinstalled apps

9

Your new MultiPhone contains several applications preinstalled by Prestigio to make using MultiPhone more comfortable right from the box.



Following applications you can find in all apps list by touching  icon on the Home screen:

Application	Description
 eReader Prestigio	Prestigio branded bookstore. You can download and read Your favorite books are here here. Please read a detailed eReader Prestigio User manual provided (Appendix A)
 Facebook	Stay always connected with Your friends and family with Facebook social network
 Twitter	Your favorite Twitter app. now always with You. Create and send Your messages from anywhere.
 OfficeSuite	Increase Your productivity with mobile office application.
 Angry Birds Chess Free	And games, of course. Angry Birds – favorite game of millions! Classic Chess – game of all times.
 SugarSync	Let Your important files synchronized from everywhere! It is a client for cloud storage service.
 Explorer	Manage Your files with this application.

10. Settings

10

Control and customize your device settings on the Settings screen.

To open the Settings screen, tap  to enter application list and tap Settings icon .

You can scroll list of settings options up and down to find the necessary item.

10.1 SIM management

As the name suggests this option will help you configure the SIM(s) on your Android device

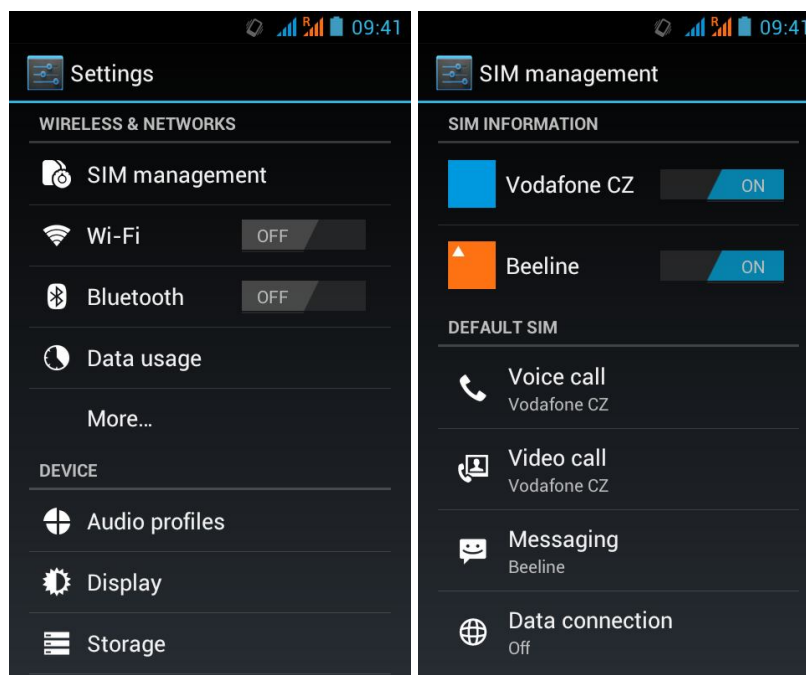

You can have the SIM's switched ON or OFF using the individual toggle switches as seen on a screenshot above.

Voice Call - This option allows you to choose the default SIM to be used for making Voice Calls, unless you have chosen the option "Always ask" in which case you will be prompted to choose the SIM for every call you make. SIM 1 is chosen by default.

Video Calls - This option gives you the same choice as explained in point 3, but for Video Calls instead of Voice Calls. Please note that video call option should be available for you connection plan and supported by your mobile network provider.

Messaging - you choose here the default SIM for sending messages. Again, you have the option to choose 'Always Ask', if you wish so.

Data Connection - option elps you choose the SIM that would be used for connecting to Internet. This may come in handy if you are on roaming and possess SIM cards for 2 different states/countries.

Tap the respective SIM card to enter the second level menu for this particular SIM card

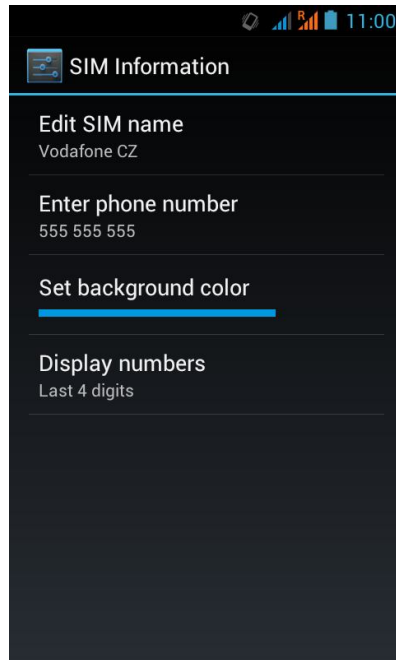

You may **Edit SIM name** (by default it's named according to the mobile network provider), and change it e.g. like "Work" or "Private".

Menu also allows you to **Enter the Phone Number** related to this SIM for your reference.

The third option allows you to **Change background color** for easier identification of the SIM card and related events – phone calls and messages.

10.2 Wireless & networks

Configure your device's wireless connections, e.g., Wi-Fi, Virtual Private Networks, or set the options for Portable hotspot.

Wi-Fi

To turn on/off Wi-Fi, simply slide your finger rightward/leftward on the control bar.

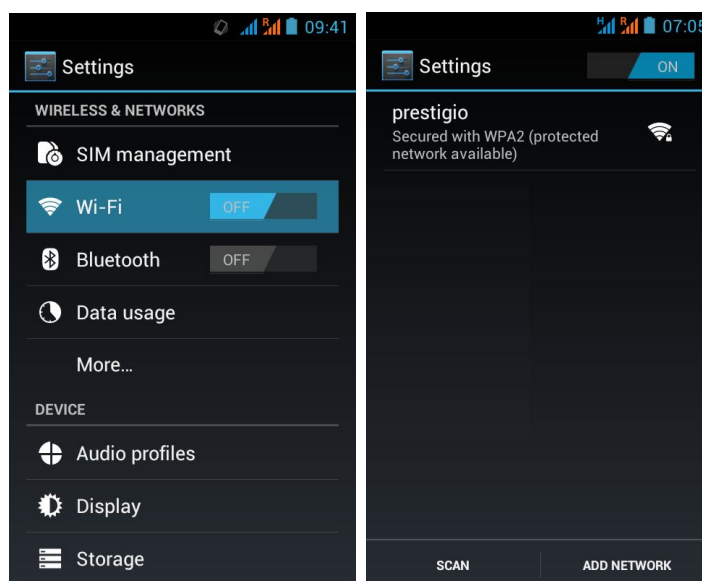

BlueTooth

To connect to a Bluetooth device, first turn on your phone's Bluetooth. Then, the first time you use a new Bluetooth device, you need to "pair" it with your phone so that both devices know how to connect securely to each other. After that, they connect automatically.

[Note] To extend the life of your battery between charges, turn off Bluetooth when you're not using it. You may also be required to turn Bluetooth off in some locations. Bluetooth is turned off when you switch to Airplane mode.

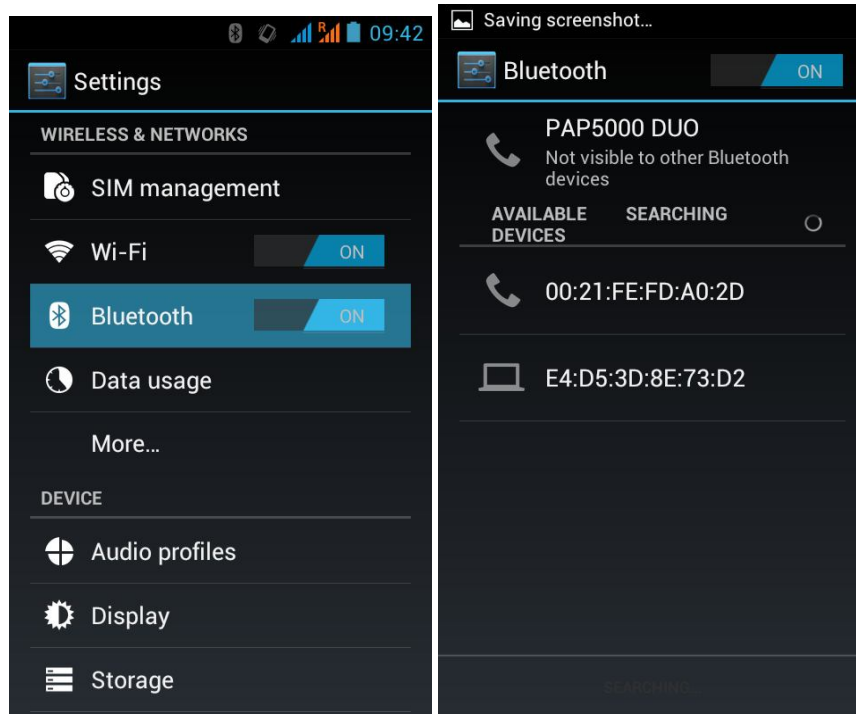

Turn Bluetooth on or off

1. Touch Settings > Wireless & networks.
2. Slide the Bluetooth switch on or off

Change your phone's Bluetooth name Your phone has a generic Bluetooth name by default, which is visible to other Bluetooth devices when you connect them. You can change the name so that it is more recognizable.

1. Under Settings > Wireless & networks, make sure Bluetooth is turned on.
2. Touch Bluetooth.
3. In the Bluetooth screen, touch Menu > Rename phone.
4. Type a new name and touch Rename.

Pair your phone with a Bluetooth device

You must pair your phone with a device before you can connect to it. Once you pair your phone with a device, they stay paired unless you unpair them.

If the device you want to pair with isn't in the list, ensure that the it's turned on and set to be discoverable.

1. Under Settings > Wireless & networks, make sure Bluetooth is turned on.
2. Touch Bluetooth. Your phone scans for and displays the IDs of all available Bluetooth devices in range.
3. If your phone stops scanning before your Bluetooth device is ready, touch Search for devices.
4. Touch the ID of the Bluetooth device in the list to pair with it.
5. Follow the instructions to complete the pairing. If you're prompted to enter a passcode, try entering 0000 or 1234 (the most common passcodes), or consult the documentation that came with the device.

If the pairing is successful, your phone connects to the device

Connect to a Bluetooth device

Once you've paired with a Bluetooth device, you can connect to it manually—for example, to switch devices or to reconnect after it is back in range.

1. Under Settings > Wireless & networks > Bluetooth, make sure Bluetooth is turned on.
2. In the list of devices, touch a paired but unconnected device. When the phone and the device are connected, the device is displayed as connected in the list.

Configure or unpair a Bluetooth device

Some Bluetooth devices have multiple profiles. Profiles can include the ability to transmit your conversations, play music in stereo, or transfer files or other data. You can select which profiles you want to use with your phone. You can also change the name of the Bluetooth device as it appears on your phone.

1. Under Settings > Wireless & networks > Bluetooth, make sure Bluetooth is turned on.
2. In the Bluetooth settings, touch the Settings icon beside the connected Bluetooth device you want to configure.

A screen opens that allows you to change the device's name, unpair it, or select profiles. Touch the Back button when you're finished.

Data Usage

Data usage refers to the amount of data uploaded or downloaded by your device during a given period. Depending on the device and your wireless plan, you may be charged additional fees when your data usage exceeds your plan's limit.

To monitor your data usage, go to **Settings > Wireless & networks > Data usage**



The usage displayed on the data usage settings screen is measured by your phone. Your carrier's

data usage accounting may differ. Usage in excess of your carrier plan's data limits can result in steep overage charges. The settings described here can help you track your usage, but are not guaranteed to prevent additional charges.

Data usage settings allow you to:

- Set the data usage level at which you'll receive a warning.
- Set a data usage limit.
- View or restrict data usage by app.
- Identify mobile hotspots and restrict background downloads that may result in extra charges

More...

This menu allows you to Enable Airplane mode (turn all the connections off), setup Virtual Private Network (VPN) or enable WiFi hotspot.

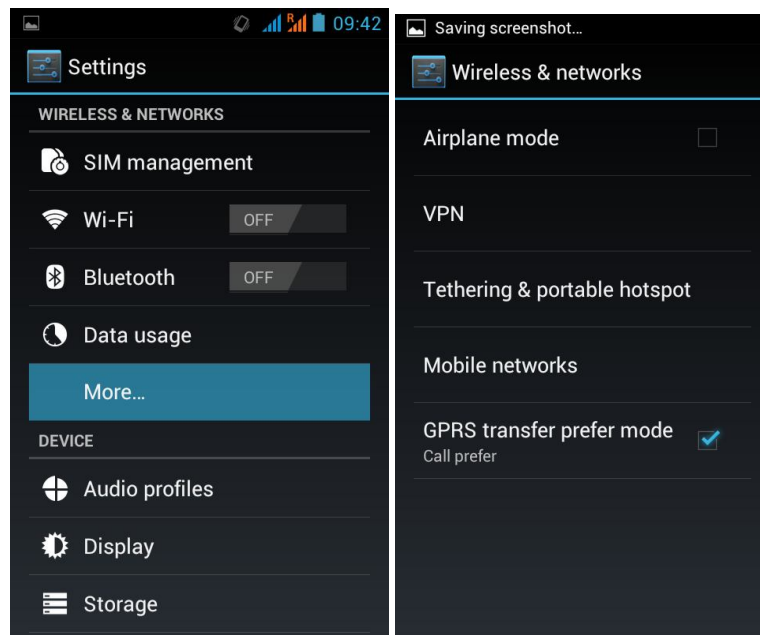

10.3 Audio Profiles

Use the Audio profiles to configure how and at what volume the phone rings, vibrates, or alerts you in other ways when you receive a call, you receive a notification, or an alarm sounds

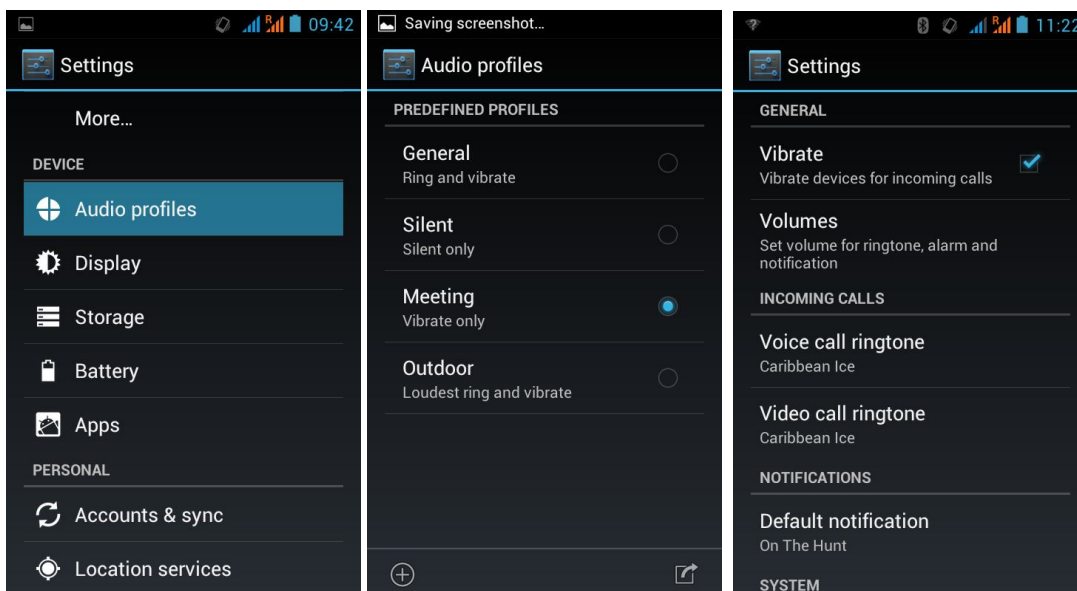

You also use these settings to set the volume for music or other media with audio and some related settings. Tap on the desired profile and new window will appear where you can set settings for this profile.

Vibrate sets the phone to vibrate whenever you receive an incoming call or notification.

Volumes sets the master volume separately for music, notifications, and alarms.

You can still use the physical volume control on the phone to raise or lower volume of whatever sound is currently playing.

Default notification announces the arrival of notifications unless you specify a different sound in an individual app.

Touch sounds gives audible feedback when you touch active icons or buttons on the screen.

Screen lock sound is triggered when you unlock the screen System

Use the checkers to enable/disable Touch sounds or screen lock sound

10.4 Display

Set the screen brightness, auto-rotate option, wallpaper, screen timeout and font size.

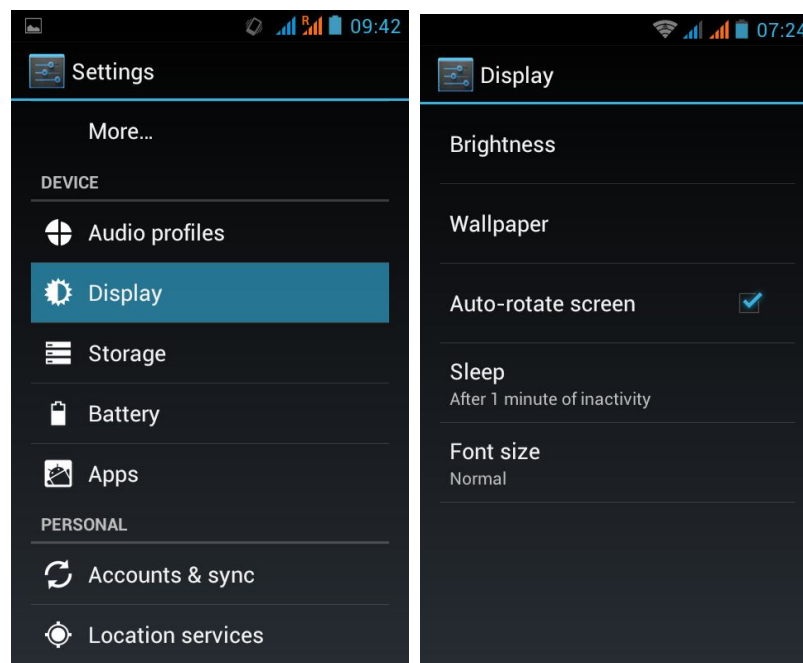

Brightness

Use the slider to set a brightness level you want at all times when using MultiPhone. For the best battery performance, use the dimmest comfortable brightness.

Wallpaper

Tap to select source of wallpaper and set wallpaper for the device.

Auto-rotate screen

Check to enable/disable automatic switch of the orientation of the screen when you turn the device.

Sleep

Open a dialog where you can set how long to wait after you tap the screen or touch a button before the screen darkens. For the best battery performance, use the shortest convenient timeout.

Font size

Open a dialog where you can set font size.

10.5 Storage

Check the usage condition of the storage space on the internal & external storage card. You can erase all data on the SD card and unmount the external SD card for safety removal.

Unmount the SD card: Tap **Settings > Storage > Unmount SD card > OK**.

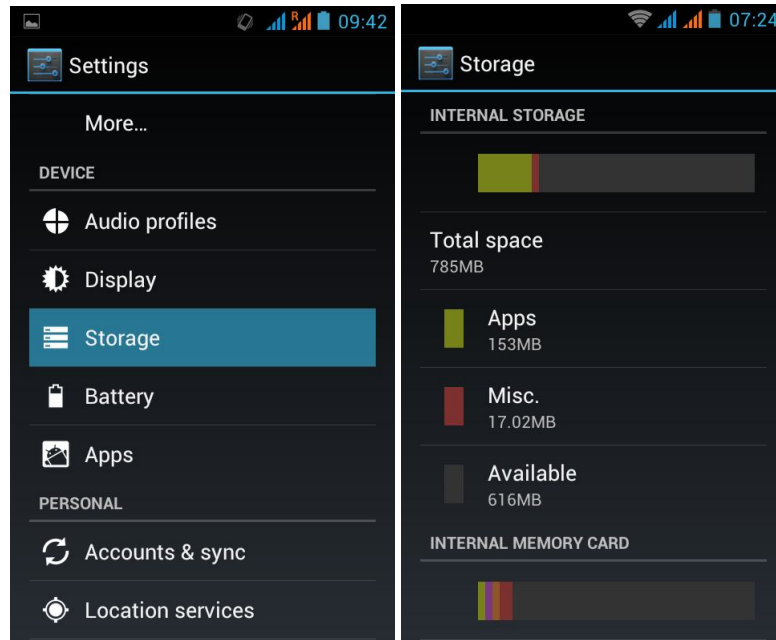

10.6 Battery

Shows status of the battery (Discharging or Charging, when connected to a charger), displays battery level in percents and presents which processes/applications consumes the battery charge



Tap  to reset the information on the screen (uptime and consumption structure).

10.7 Apps

Use the Applications settings to view details about the applications installed on your phone, to manage their data, to stop them if have any problems in downloading.

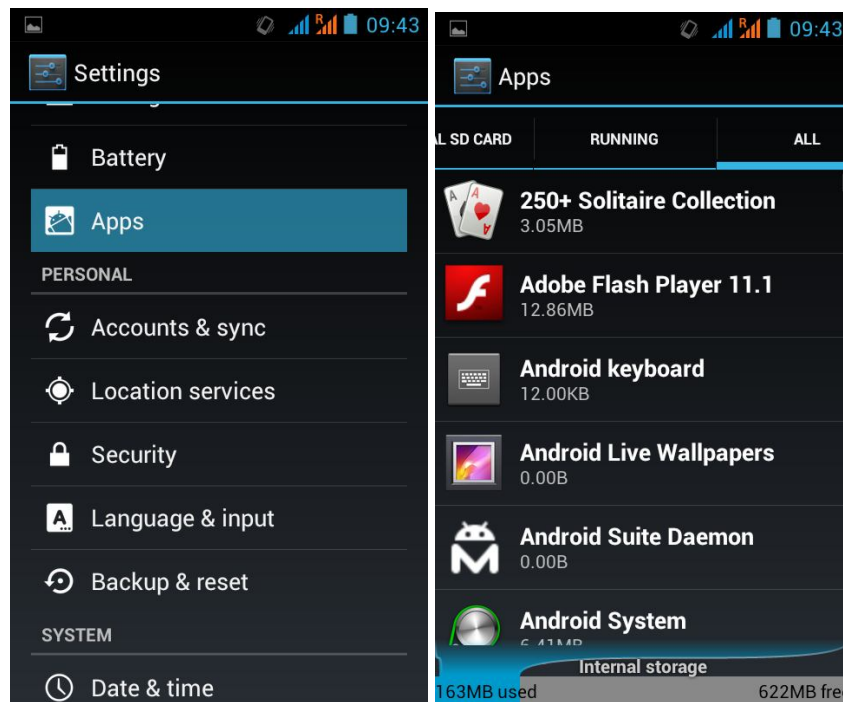

Apps Open a list of all the applications and other software installed on your MultiPhone, along with their sizes. By default, only downloaded applications are shown, and they are sorted in alphabetical order. Touch Menu button and tap **Sort by size** to display applications in order by size. Tap an application to open its Application Info screen.

To manage and /or remove downloaded applications, tap **Settings > Apps > Downloaded**.

Running services

To check and control running service, tap **Settings > Apps > Running**.

10.8 Accounts & Sync

Use the Accounts & Sync settings to add, remove and manage your Google and other accounts.

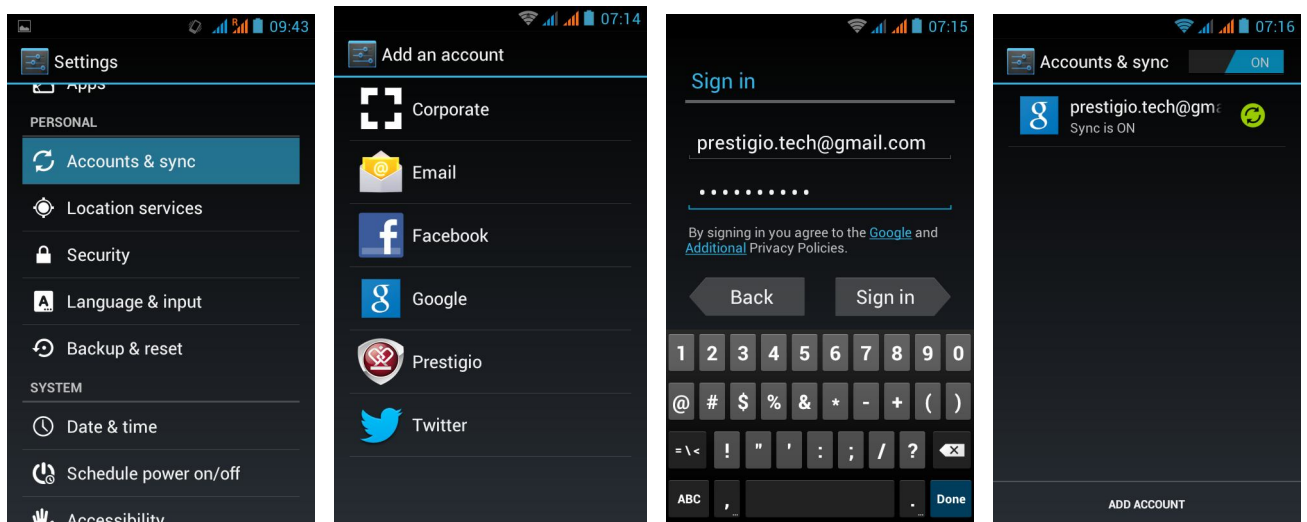

You also use these settings to control how and whether applications send, receive and sync data on their own schedules and whether applications can synchronize user data automatically. Gmail, Calendar and other applications may also have their own settings to control how they synchronize data; for more details see the documentation of those applications

Tap **ADD ACCOUNT** in the above screen to add new accounts by following onscreen instructions. Tap the icon  to prompt the following screen to manage your accounts:

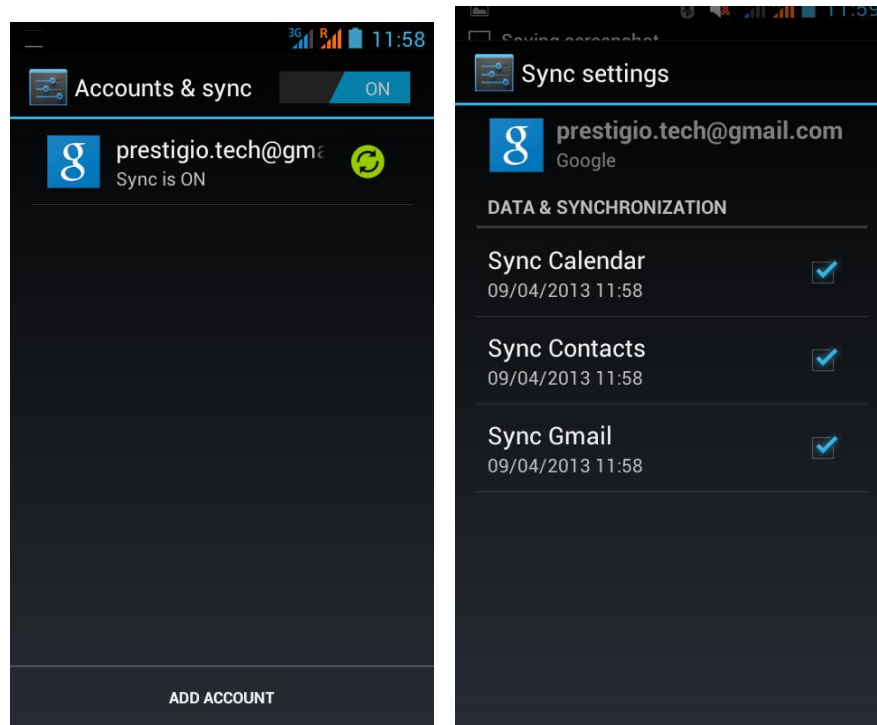

Check to turn on/off data synchronization for exact type of data.

Touch the Menu button of the smartphone and then tap **Remove account** if you want to remove the selected account from your device.

10.9 Location service

Enable applications using data from sources such as Wi-Fi and mobile networks to orientate your location and improve Google search results via check the options.

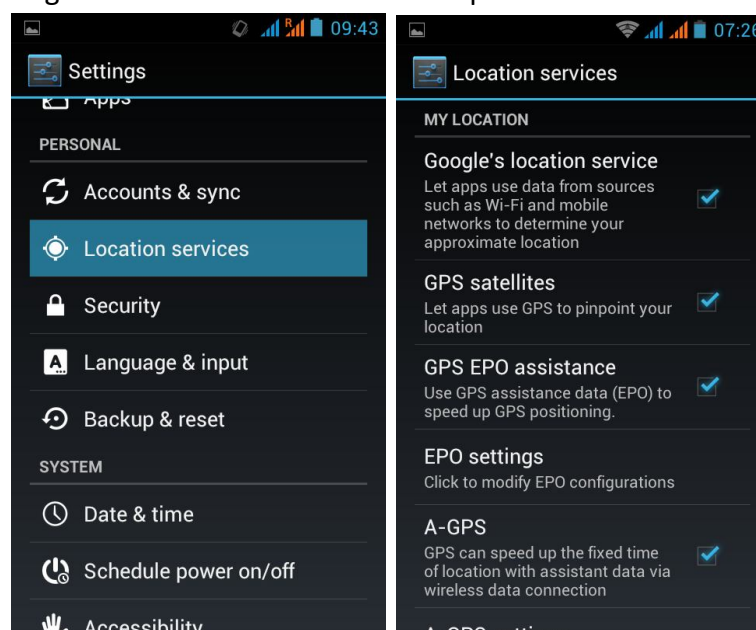

10.10 Security settings

Set the screen lock mode and owner information, encrypt your device, manage password and administrate your device.



To personalize the screen lock mode of your device, tap **Settings > Security > Screen lock**

The following options are possible to choose:

- **None** – this one means no screen lock will be enabled at sleep/resume/system on step
- **Slide** – you have to slide the screen lock button to one of directions (unlock-camera-Google web-page)
- **Face Unlock** - Face Unlock lets you unlock your phone by looking at the screen. After you set it up, look under **Settings > Personal > Security** for two additional settings: **Improve face matching** and **Liveness** check. Use these to make Face Unlock more reliable and secure.
- **Pattern** - lets you draw a simple pattern with your finger to unlock the phone. This is slightly more secure than Face Unlock.
- **PIN** – **If you choose this option it will require you to enter 4 or more numbers to unlock the MultiPhone**
- **Password** - This is the most secure option, as long as you create a strong password.

[Note]: There is no way to recover password/pin/pattern lock, in case you forget the correct logon info. The only way to erase this lock is to perform complete device reset or, e.g. firmware reinstallation. All user's apps and files will be lost in this case.

Owners Info

It's possible to show owner's info on lock screen. Choose this option in this menu and Type the text to display on the lock screen in the text box below.

Passwords

Check the box if you'd like to make the passwords visible while you enter them.

Device administration

You may view or deactivate device administrators in this menu, as well as enable installation of apps from unknown sources (other

Unknown sources

Check to permit installation of applications that you obtain from web sites, email, or other locations other than Google Play Store.

10.11 Language & input settings

Use the Language & Keyboard settings to select the language for the text on your phone and for configuring the onscreen keyboard, including words that you've added to its dictionary.

Set the operating system language and region by touching the setup icon . You can also set onscreen keyboard options.

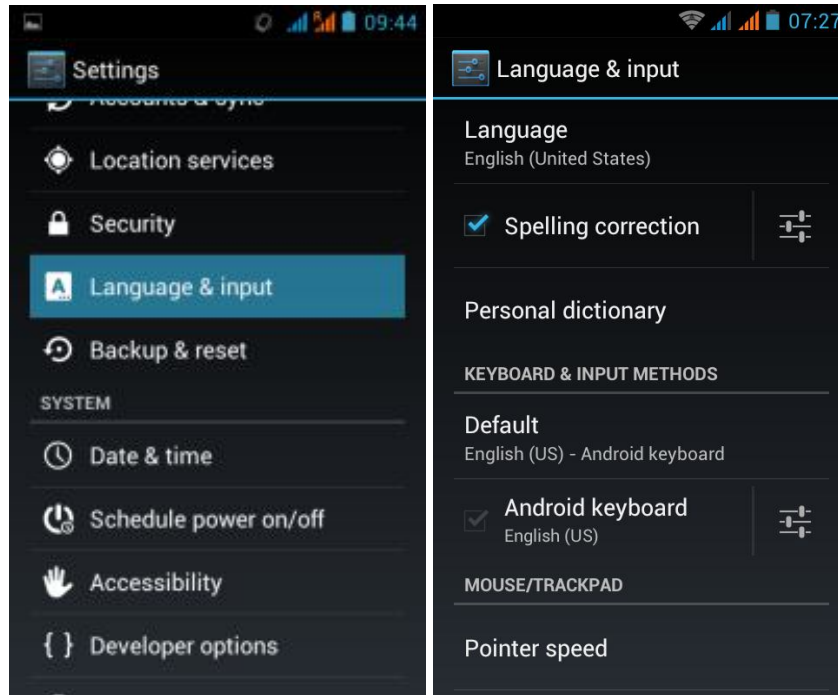

10.12 Backup & reset

You can enable or disable the automatic backup feature of the device and reset the device.

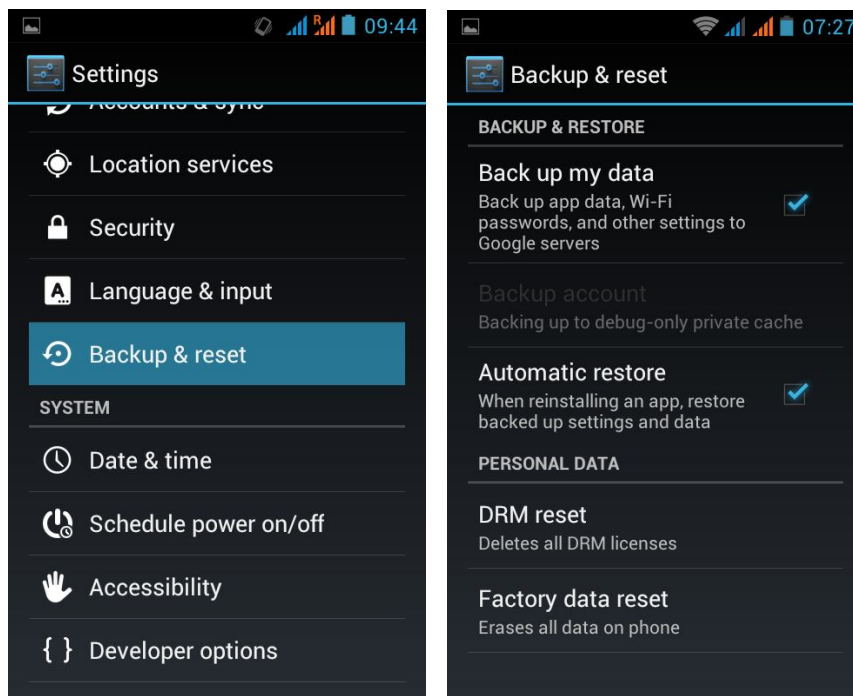

Back up my data. If you check this option, a wide variety of your personal data is backed up automatically, including your Wi-Fi passwords, Chrome bookmarks, a list of the apps you've installed on Google Play, the words you've added to the dictionary used by the onscreen keyboard, and most of your customized settings. Some third-party apps may also take advantage of this feature, so you can restore your data if you reinstall an app. If you uncheck this option, your data stops getting backed up, and any

existing backups are deleted from Google servers.

Backup account. Displays the Google Accounts whose information gets backed up. You must sign in with one or more of these accounts on a new or reset device to retrieve the associated information.

To add a new account, touch **Backup account > Add account.**

Automatic restore. Check this option to restore settings and other data when you reinstall an app. This feature requires that you are backing up your data with your Google Account and that the app is using the backup service

Factory data reset. Touch this option, then Reset phone to erase all your personal data from internal storage, including information about your Google Account, any other accounts, your system and app settings, any downloaded applications, and your music, photos, videos, and other files.

After resetting your phone, you'll need to re-enter the same information requested when you first set up your phone. If you've

been backing up your data to a Google account, an option during the setup process allows you to restore it.

[Note]: after factory data reset, you personalizing settings and the installed third-party applications will be removed from your device. Before restoring default settings, it is suggested to backup data/applications you want and remove your storage card safely in case of data loss or damage during restoring factory default settings.

10.13 Date & Time settings

Set the date and time, time zone, and date or time format. To turn off auto time synchronization simply unmark it and you will be able to manually change time settings.

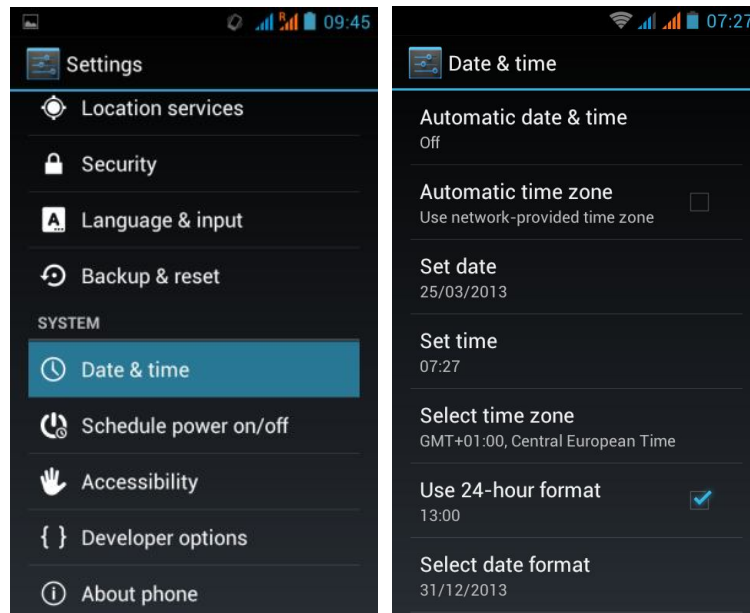

10.14 Schedule power on/off

You can set exact time, when you want automatic power off or power on your phone.

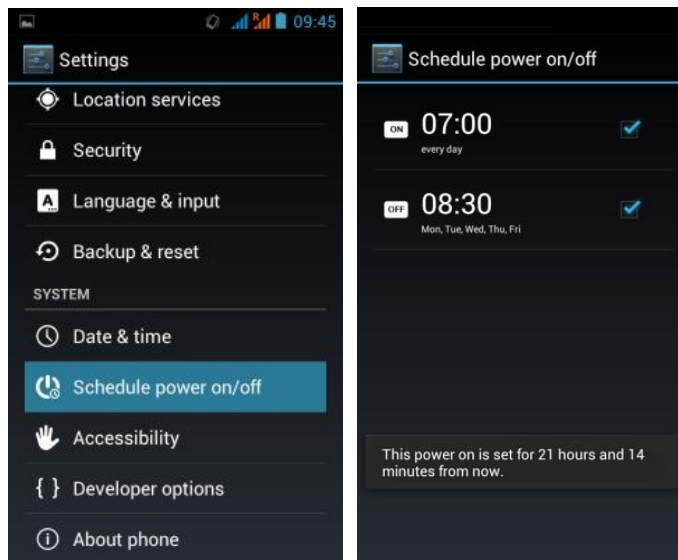

10.15 Accessibility

Smartphone's accessibility features make it easier to use in case the user has special requirements

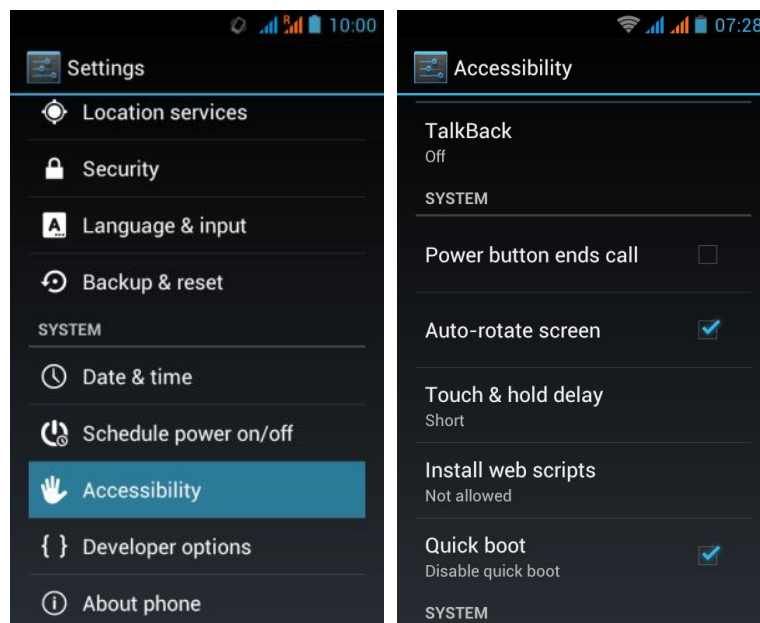

TalkBack is a pre-installed screen reader service. It uses spoken feedback to describe the results of actions, such as opening an app, and events, such as notifications

Power button ends call – check to enable this setting, which can help to operate the smartphone when calling.

Auto-rotate screen - Check to have the screen rotate automatically when you change the phone's orientation

Touch & hold delay: 3 levels of delay when touch and hold widget or icon are available – Short, Medium, Long. It regulates the duration of object hold till further actions.

10.16 Developer options

You can set the USB debugging mode, select screen stay awake while charging and so on. And you can also manage user interface and apps.

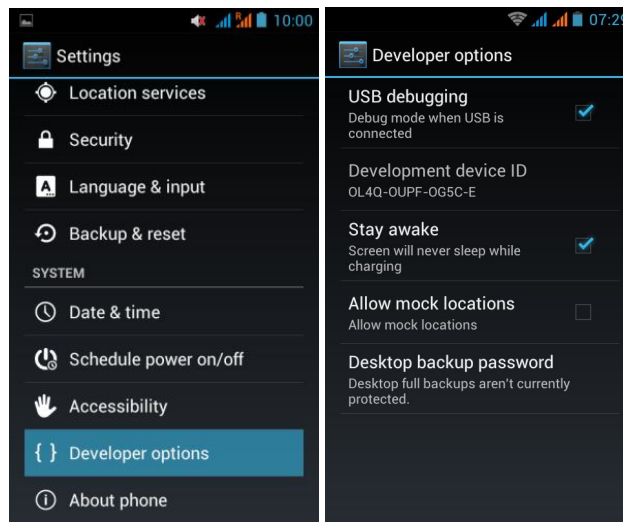

USB debugging: Check to permit debugging tools on a computer to communicate with your MultiPhone via a USB connection.

Stay awake: Check to prevent the screen from dimming and locking when the MultiPhone is connected to a charger or to a USB device that provides power. Don't use this setting with a static image on the MultiPhone for long periods of time, or the screen may be marked with that image.

Allow mock locations: Check to permit a development tool on a computer to control where the MultiPhone believes it is located, rather than using the internal methods for this purpose.

10.17 About phone

View the device status such as the network type, battery power level, and network name. You can also check the battery use of individual applications or view the legal information and firmware version (Build number; symbols vx.x.x) of your MultiPhone.

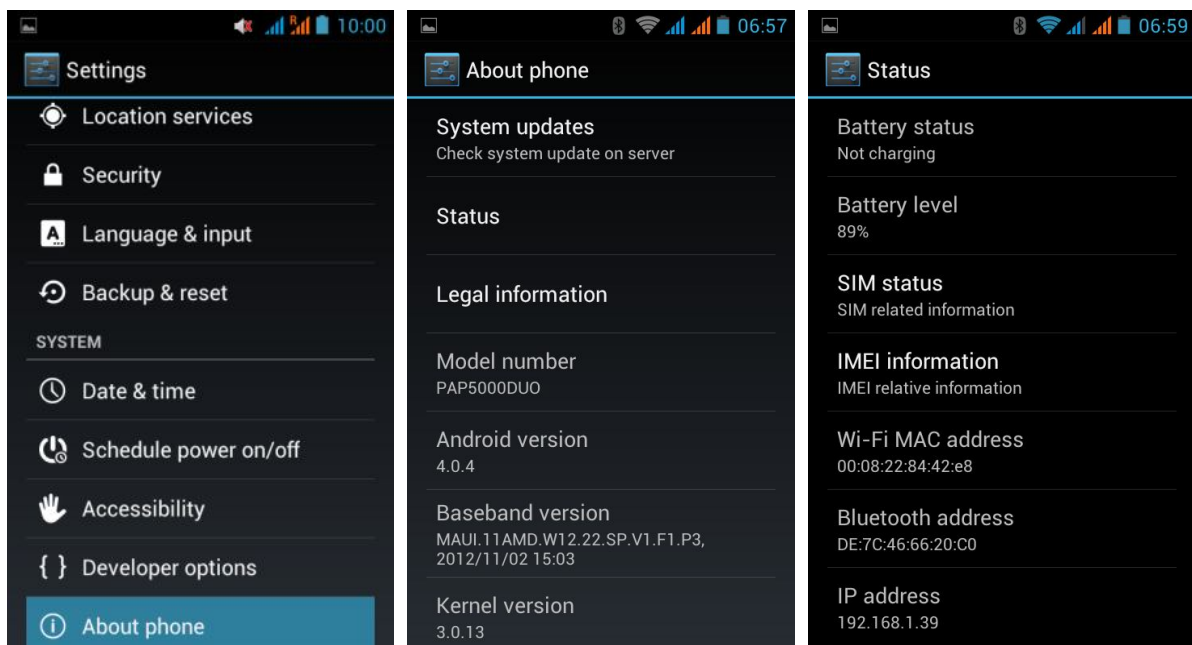

11. Troubleshooting



11.1 Forced shutdown

There is no special button which helps you to reset the device if it stops responding. If such a situation happens you may remove the back cover and detach the smartphone's battery. This operation might cause data loss though, so please backup important information on a regular basis.

11.2 Restore default settings

To restore the factory default settings, you can tap **Settings > Backup & reset> Factory data reset**.

Warning: data of your Google account, your personalized settings, and installed applications will be removed from your device once you execute factory default settings, so please make a careful decision whether to restore default settings. Before restoring default settings, it is suggested to backup data/applications you want.

11.3 System updating

After system update/upgrade, it may occur that the installed third-party applications cannot run or there is data loss or damage to the apps. This is normal phenomena rather than a system fault. You just need to download and install the third-party applications again into the device. It is recommended to backup data of the third-party applications before system update/upgrade.

Please note, that Prestigio provides OTA (Over-the-Air) update service to its customers. You may turn on/off automatic updates and perform a manual check in the following screen accessible via **Settings-About phone-System updates**:

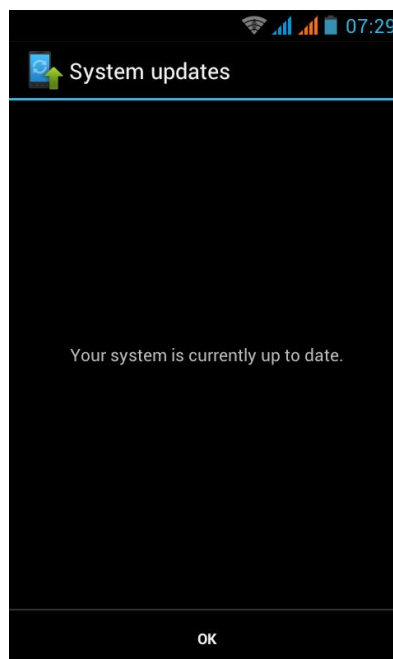

12. Glossary



Android 4.0 (Ice Cream Sandwich) - operating system for Smartphones and smartphones based on Linux kernel;

Google Play Store – online store with software for Android OS;

Google Account - pre registered user account for having access to the Google branded services and registration of MultiPhone;

MultiPhone – Prestigio trademark for Smartphone devices;

Gmail – Google branded e-mail client;

Widgets – simple programs on the Smartphone desktop for showing different information or shortcuts to installed software.

eReader Prestigio

Application Manual

1. Launching the application.

Open list of applications or main desktop window to find eReader Prestigio icon.  Tap on it to start application. Please, wait until spinner in the right top corner disappears.

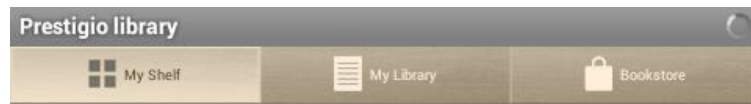

While loading application will check the default folder for the available content (mnt/sdcard/Books) and display it on the shelves.

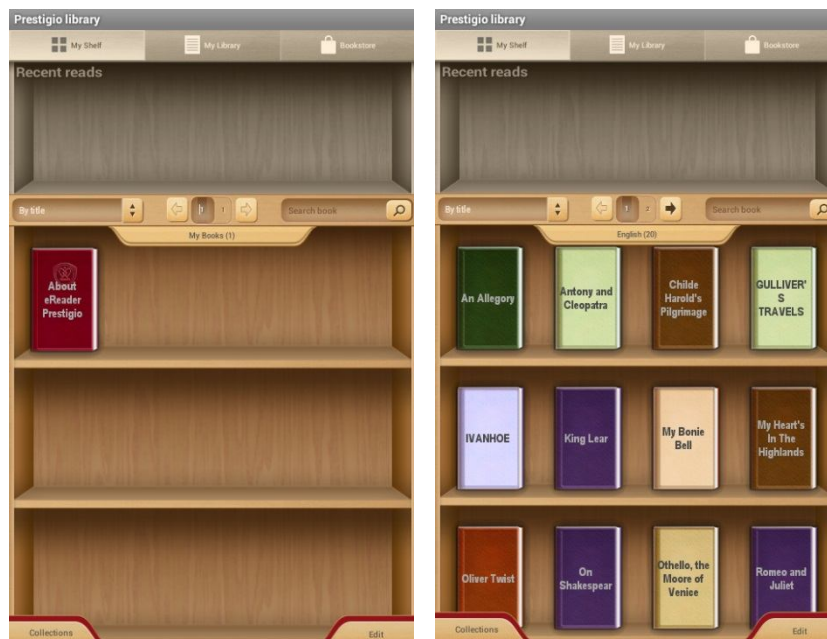

Some of the content is already preloaded on the factory and divided by languages for your comfort use.

Tap "My books" to open a list of preset folders and choose the one that corresponds to your language. Other collections can be deleted through Edit option.



2. Main Control panel.

Settings can be called from the notification bar . Use opened options to make a quick Search, Refresh your content or Enter in Settings.

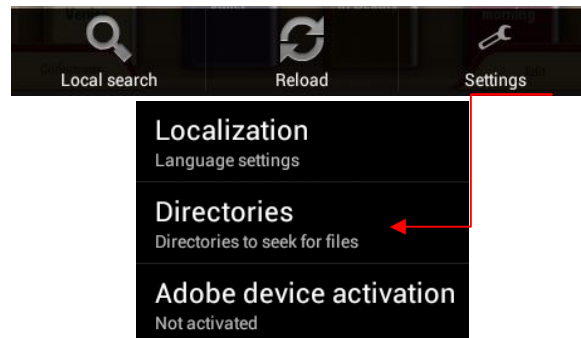

Localization. Set a custom language for your application that can be different from the Android system language.

Directories. Set any custom directory from which books will be available on the shelves.

Adobe device activation. Set Adobe Id to allow working with Adobe DRM protected books.

3. Navigation in main sections.



My Shelf is graphic presentation of the books content and its control.

My Library is the File tree and automatic grouping of the books between several assigned categories: Collections, Favorites, Recent, ...

Bookstore is the online shop of the books proposed by Prestigio to their customers in 22 languages with the possibility to Search and purchase any book directly from application.

4. Content control bar.



- 1 – Sort of the current shelves by title, author name, favorites or recently added
- 2 – Pagination block. Go to the next shelf in the frame of the same Collection or type a number of a shelf if you have more.
- 3 – Search a book with its title or its author's name. Enough to type part of the name to start Searching. Found books will be shown on the shelf. To return to the collection view it's necessary to empty search bar and press Done.
- 4 – Collections list. Application works with folders if you already have your own library on the PC you can copy to a Prestigio e-book reader or create markers on any book

11 Work with the Collections.

“My books” contains all the books from the selected directory. It's a default collection that can't be removed or renamed.

Press on “My books” or “Collections” to start navigation in the list of preset or preloaded collections.



List of the collections can be edited through Edit or Add new button.



Edit. Option allows you renaming collections or deleting any selected with a marker collection. Delete the collection doesn't mean that books will be erased physically from the device.



Any book or a group of the books can be moved from one collection to another or deleted from the device and collection.

Select  on the main shelf to start working with books. A new control bar will be available.



Move - Allows to move a book from a collection to another chosen collection.

Delete - Remove all selected books from the application and device.

Select all - Option will mark all books not only on the opened shelf but on all other shelves of a collection. Be very careful as it also allows to Delete all books from the collection.

Done - Tap when all operations with the books on the shelves are finished.

When Edit option is activated on the shelf it's possible to mark any book on any shelf just by clicking on a cover. Then other options will help to Move or Delete chosen content.



12 Reading a book.

To read a book it's enough to press on its cover on a shelf.

Settings options can be opened via Context menu .

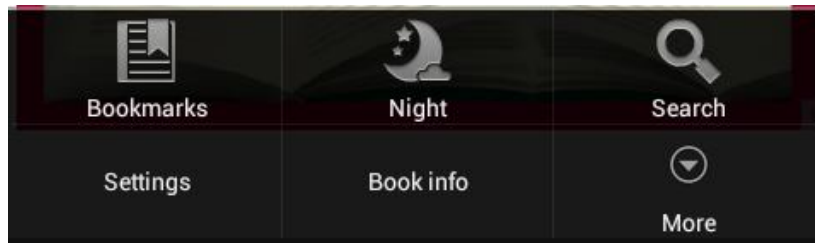

Bookmarks. Return to the most interesting places in a book with a bookmarks made.

Night. By default any book is read in Day mode (white backend + black font). It can be easily switched to a night mode to keep user’s eyes in safe.

Search. Allows to find a word or expression in the text of a book.

Settings. Customization option to get the reading experience in a comfortable way: Appearance, Text size, Text font, Colors and Wallpapers, Scrolling and Indicators.

Book info.

More... Open navigation panel to jump easily to any book page, adjust Brightness or set Font size with one touch.

Any read book will appear on the main screen in Recent read section from the left side.



Press on the book from the shelf to continue reading from the last opened page.

13 Work with Bookstore.

Bookstore in the device is available in the form of OPDS catalog: simple form of the books list that mirrors www.ebooks.prestigioplaza.com web-shop.

Catalog can be navigated like a tree with 2 main categories: Themes & genres and Authors.

Fiction Fiction (58)	B Show authors starting with B... (1127)
Arts. Architecture Arts. Architecture (3)	C Show authors starting with C... (1836)
Business Books Business Books (4315)	D Show authors starting with D... (1613)
Science Fiction and Fantasy Science Fiction and Fantasy (275)	E Show authors starting with E... (1184)
For young and teens For young and teens (365)	F Show authors starting with F... (1060)
Other Other (801)	G Show authors starting with G... (1310)
Travel Travel (443)	H Show authors starting with H... (1380)

Continue navigation until you find a book or a genre that might be interesting for you.

To search for a specific author or a book use the option **Network Search**.

Refresh catalogs can be used in a case when first connection to Bookstore was made without Internet connection.



Found book will be displayed with a detailed info and price if applicable. Free books will have **Download** button instead of **Buy ...**

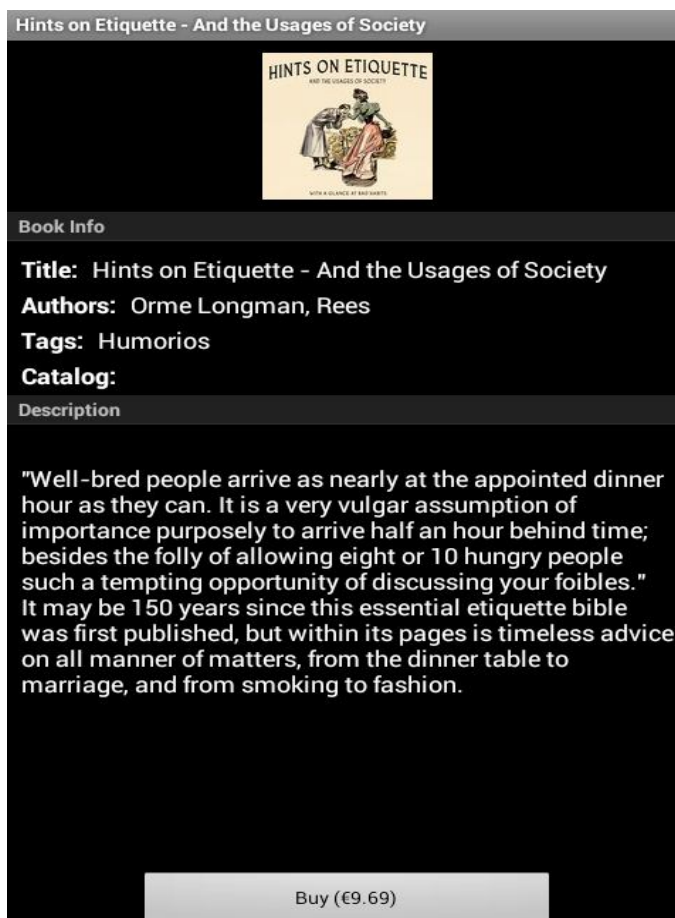

To purchase a book press **Buy...** and than **Sign in** or Register My Prestigio account. If account is active and balance is enough to make a transaction then download will be started automatically.

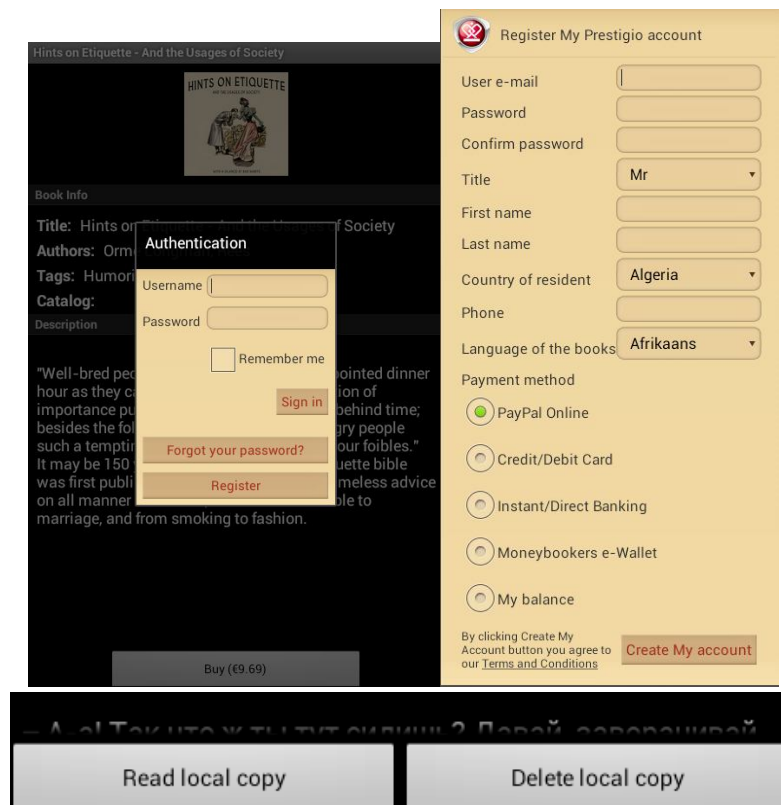

Attention: in case of unstable Internet connection or if download didn't start, please, check **My orders** in the application or visit your **Prestigio Cabinet** on the web-pages to check the order and download a book separately.

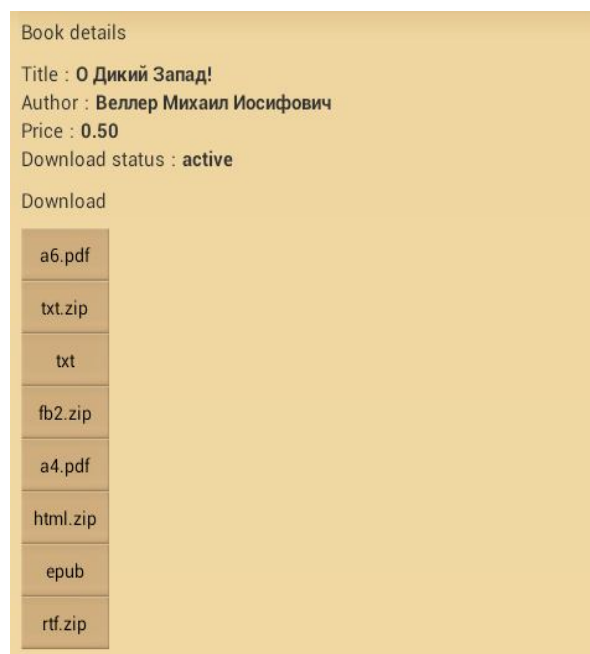

Prestigio Cabinet can be found on the main screen of OPDS catalog in the bottom line.



My account shows up only to signed in users.

My Prestigio will help you to control your balance, personal info and orders without going into Prestigio web site.



Overview. General information about account holder and his/her balance.

Personal Info. Login, first/last name, country of residence and phone number. Also option to Change password.

Language. Language of the books preferred for reading.

My Balance. Quick option to refill balance and continue buying books with one touch only.

My orders. List of all transactions made by an user in application or at Prestigio site www.ebooks.prestigioplaza.com.

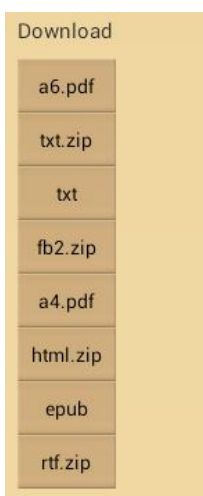

Once download links are not expired it's possible to get a book from an order details to a mobile device. Downloaded book will be available in "My books" after Refreshing collections or can be found in section **My Library** using File tree.