

ODIN-W160 USER MANUAL

1 Table of Content

- 1 Table of Content
- 2 Introduction
 - 2.1 Document Overview
 - 2.2 Key Features
 - 2.3 Product Variants
- 3 Electrical Interface and Connectors
 - 3.1 Primary Side Connector
 - 3.2 Secondary Side Connector
 - 3.3 J6 External Antenna Connector
 - 3.4 Electrical Characteristics
 - 3.4.1 Power Supply
 - 3.4.2 I/O DC Characteristics
 - 3.4.3 LPO Requirements
 - 3.5 Host Interface
 - 3.5.1 Wireless LAN and SDIO
 - 3.5.2 Bluetooth UART
 - 3.6 Environmental Characteristics
 - 3.7 Mechanical Characteristics
- 4 Antenna Information
 - 4.1 External Antennas
 - 4.2 Antenna Accessories
 - 4.3 Antennas
 - 4.3.1 Recommended antennas
 - 4.3.2 Alternative antennas
- 5 Mounting Information
 - 5.1 Module Dimensions
 - 5.2 PCB Solder Lands
 - 5.2.1 Host Board
 - 5.2.2 Mounting Process
- 6 Regulatory Information
 - 6.1 CE compliance
 - 6.1.1 Equipment classes
 - 6.1.2 Declaration of Conformity
 - 6.2 IC and FCC compliance
 - 6.2.1 IC compliance
 - 6.2.2 Conformité aux normes d'IC
 - 6.2.3 FCC statement
 - 6.3 Compliance with RoHS Directive
- 7 Guidelines for Efficient and Safe Use
 - 7.1 General
 - 7.2 Product Care
 - 7.3 Radio Frequency Exposure
 - 7.4 Electronic Equipment
 - 7.5 Potentially Explosive Atmospheres
 - 7.6 Safety Compliance

2 Introduction

The ODIN-W160 is a Multi Radio Module providing both IEEE 802.11a,b,g,n Wireless LAN and Bluetooth 4.0, including Classic Bluetooth and Bluetooth low energy. It has been developed for integration in industrial devices. The module provides features such as low power, robustness, reliability and compatibility. By using the module the work needed to implement IEEE 802.11 and/or Bluetooth in a device is minimized as it provides, together with the driver package, all software, hardware, type approval, EMC certification etc. It is developed for reliable, high demanding industrial devices and applications and delivers high performance.

The Wireless LAN section of the module can be operated on 5 frequency bands and conforms to IEEE 802.11a,b,g and 802.11n single stream.

- ISM Band (2412 – 2472 MHz), 13 channels with a separation of 5MHz
- UNII band-1 (5180 – 5240 MHz), 4 channels with a separation of 20MHz
- UNII band-2 (5260 – 5320 MHz), 4 channels with a separation of 20MHz
- UNII band-2e (5500 – 5700 MHz), 11 channels with a separation of 20MHz
- UNII band-3 (5745 – 5825 MHz), 5 channels with a separation of 20MHz

The Bluetooth section of ODIN-W160 operates in the unlicensed ISM band between 2402 – 2480 MHz and has two operating modes with somewhat different behaviour.

- Bluetooth Classic (BT+EDR)
In this operating mode it uses 79 RF channels with 1 MHz spacing
- Bluetooth Low Energy (BLE)
In this operating mode it uses 39 RF channels with 2 MHz spacing

ODIN-W160



2.1 Document Overview

This User Manual is applicable to the following Wireless LAN module:

- ODIN-W160

2.2 Key Features

- Multiradio module:
 - Dual-band Wireless LAN operation (IEEE 802.11-2007a,b,g and single stream IEEE 802.11n)
 - Bluetooth 4.0
- Ready-to-use:
 - No production tests required
 - RF tuned from factory
 - Contains own MAC address
- Host interfaces:
 - Wireless LAN: SDIO
 - Bluetooth: UART
 - RF parameters and MAC address: I²C
- Small footprint
 - 22.3 x 14.8 x 2.9 mm
- WEP, AES hardware accelerators
- WPA and WPA2 support - both personal and enterprise modes
- Quality of Service: 802.11e and WMM
- Ad-hoc and infrastructure mode
- Radio type approved for Europe
- Unlicensed Modular Transmitter Approval for US (FCC) and Canada (IC)
- Compliant with EMC standards
- Medical approval
- Industrial temperature range -40 to +85 °C
- Support for low power modes
- External antenna via U.FL connector

2.3 Product Variants

Product name	Regulatory ID FCC ID IC ID	Description
ODIN-W160	Model: ODIN-W160 PVH0953 5325A-0953	Wireless LAN IEEE 802.11a,b,g,n module with U.FL. coaxial connector for external antenna

3 Electrical Interface and Connectors

Host interface and control signals are accessible via PCB solder lands at the edge of the PCB.

3.1 Primary Side Connector

Top view of module, J6 is a HIROSE type U.FL coaxial connector for external antenna.



3.2 Secondary Side Connector

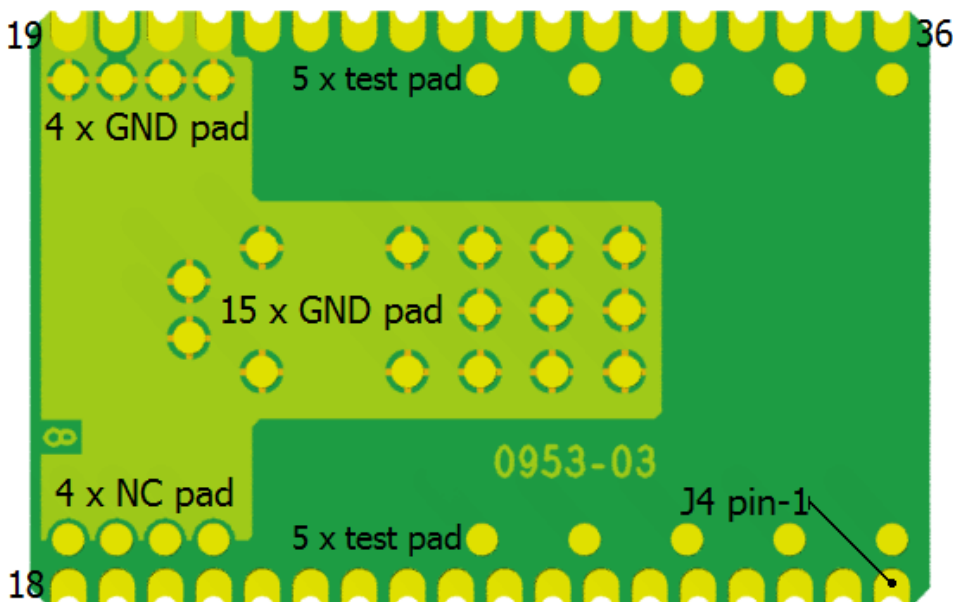

3.3 J6 External Antenna Connector

J6 is the external antenna connector. It is used for both transmit and receive. The port impedance to match is 50 ohm.

J6 pin nr	Pin name	Signal level	Type	Description
1	Ant-1	RF	I/O	U.FL. external antenna port (50 ohm)

3.4 Electrical Characteristics

3.4.1 Power Supply



Read the safety notes in section Guidelines for Efficient and Safe Use before using the modules.

3.4.1.1 Supply Voltage Requirements

Symbol	Parameter	Min	Typ.	Max	Unit
V_{DD}	Supply voltage	3.0	3.3	3.6	V
V_{IO}	IO Supply voltage	1.75	1.8	1.9	V

3.4.2 I/O DC Characteristics

Symbol	Parameter	Min	Typ	Max	Unit
V_{IL}	LOW level input voltage	0		$0.35 \times V_{IO}$	V
V_{IH}	HIGH level input voltage	$0.65 \times V_{IO}$		V_{IO}	V
V_{OL}	LOW level output voltage	0.0		0.45	V
V_{OH}	HIGH level output voltage	$V_{IO} - 0.45$		V_{IO}	V
I_{IO}	Sink and source current			8.0	mA
C_{IO}	Input capacitance		8		pF

3.4.3 LPO Requirements

Symbol	Parameter	Min	Typ	Max	Unit
LPO-32kHz	Frequency	32763	32768	32773	Hz

3.5 Host Interface

The module has two primary host interfaces, SDIO for the Wireless LAN section and UART for the Bluetooth section.

3.5.1 Wireless LAN and SDIO

The interface between the host and the module is a standard SDIO interface (See SDIO spec Version 2.0) with Out Of Band interrupt, supporting maximum clock rate of 25MHz. The SDIO interface also supports the following features:

- Both 1 and 4 bit data bus
- Functions number 0 and 2
- Multi-Block data transfer

The WLAN block uses function 2. Function 0 is used for the common I/O area.

3.5.2 Bluetooth UART

The module incorporates one UART dedicated to the Bluetooth Host Controller Interface (HCI) transport layer. The HCI interface is used to transport commands, events, ACL and synchronous data between the device and its host using HCI data packets.

The following HCI transport layers are supported (detected automatically when communication starts):

- HCI four-wire (H4)
- HCI three-wire (H5)

The HCI interface has a 256 byte receive buffer and supports most baud rates, including all normal PC rates, up to a maximum of 4 Mbps. After power-up, the baud rate is set for 115.2kbps. The maximum baud rate deviation supported is -2.5%, +1.5%.

The baud rate can be changed with a vendor specific command. The module responds with a Command Complete Event (still at 115.2kbps), after which the baud rate change takes place. The only parameter needed is the desired baud rate.

HCI hardware includes the following features:

- Receiver detection of break, idle, framing, FIFO overflow, and parity error conditions
- Transmitter underflow detection
- CTR/RTS hardware flow control (H4)
- XON/XOFF soft flow control (H5)

Parameter	Values
Baud rates	Min: 37.5 kbps Max: 4000 kbps
Default baud rate	115.2 kbps
Data bits	8
Stop bits	1
Parity	none
Flow control	None, XON/XOFF, CTS/RTS

3.6 Environmental Characteristics

Parameter	Min	Typ	Max	Unit
Storage temperature	-40		+95	degC
Operating temperature	-40		+85	degC

3.7 Mechanical Characteristics

Parameter	Value type	Value	Unit
Weight	Typ	1.5	g
Outline dimension	Typ	22.3 x 14.8 x 2.9 (+/- 0.1 mm)	mm

4 Antenna Information

This chapter gives an overview of the different external antennas that can be fitted to the module.

4.0.0.1 Caution



This radio transmitter IC: 5325A-0953 has been approved by Industry Canada to operate with the antenna types listed below with the maximum permissible gain and required antenna impedance for each antenna type indicated. Antenna types not included in this list, having a gain greater than the maximum gain indicated for that type, are strictly prohibited for use with this device.

Cet émetteur radio IC: 5325A-0953 a été approuvé par Industry Canada pour fonctionner avec les types d'antenne énumérés ci-dessous avec le gain maximum autorisé et l'impédance nécessaire pour chaque type d'antenne indiqué. Les types d'antenne ne figurant pas dans cette liste et ayant un gain supérieur au gain maximum indiqué pour ce type-là sont strictement interdits d'utilisation avec cet appareil.

4.1 External Antennas

External antennas are connected to the module via the on board U.FL connector. Some antennas are connected directly to the U.FL connector and some are connected via a U.FL to SMA (cB-ACC-18 or cB-ACC-48) or U.FL to reversed polarity SMA (cB-ACC-38) adapter cable.

The sections below lists the antennas that are included in the radio type approvals of the module. For each antenna the "Approvals" field defines in what country/region the antenna is allowed to use. Definitions of the "Approvals" field are:

- **FCC** - The antenna is included in the FCC test reports, and thus approved for use in countries that accept the FCC radio approvals, primarily US.
- **IC** - The antenna is included in the IC (Industrie Canada) test reports, and thus approved for use in countries that accept the IC radio approvals, primarily Canada.
- **R&TTE** - The antenna is included in the R&TTE test reports, and thus approved for use in countries that accept the R&TTE radio approvals, primarily the European countries.

In general, antennas with Reverse Polarity SMA connector or U.FL connector are included in FCC, IC and R&TTE radio tests. Antennas with SMA connector are not allowed to be used in Canada and USA due to FCC/IC regulations but are in general included in R&TTE radio tests.

Antennas with a part number in the form "cB-ACC-XX" are available for orders via the connectBlue distribution network. For information about other antennas please contact connectBlue

4.2 Antenna Accessories

Part Number	cB-ACC-18 / cB-ACC-48	
Name	U.FL to SMA adapter cable	
Connector	U.FL and SMA jack (outer thread and pin receptacle)	
Cable length	120 mm	
Cable loss	Less than 0.5 dB	
Comment	The SMA connector can be mounted in a panel	
Approval	R&TTE	

Part Number	cB-ACC-38	
Name	U.FL to Reverse Polarity SMA adapter cable	
Connector	U.FL and Reverse Polarity SMA jack (outer thread and pin)	
Cable length	120 mm	
Cable loss	Less than 0.5 dB	
Comment	The Reverse Polarity SMA connector can be mounted in a panel	
Approval	FCC, IC, R&TTE	

4.3 Antennas

4.3.1 Recommended antennas

Part Number	cB-ACC-53	
Name	Ex-IT WLAN RP-SMA (dual-band)	
Manufacture	ProAnt	
Polarization	Vertical	
Gain / Imp.	+3.0 dBi / 50ohm @ 2.4 GHz +3.0 dBi / 50ohm @ 5 GHz	
Size	Ø 10 x 107 mm	
Connector	Reverse Polarity SMA plug (inner thread and pin receptacle)	
Comment	To be used together with the U.FL to RP-SMA adapter cable (cB-ACC-38)	
Approval	FCC, IC, R&TTE	

Part Number	cB-ACC-63	
-------------	-----------	--

Name	Ex-IT 2400-MHF 28-001	
Manufacture	ProAnt	
Polarization	Vertical	
Gain / Imp.	+2.0 dBi / 50ohm @ 2.4 GHz	
Size	Ø 12 x 28 mm	
Cable length	100 mm	
Connector	U.FL	
Comment	To be connected to the U.FL connector residing on the module	
Approval	FCC, IC, R&TTE	

Part Number	cB-ACC-61	
Name	Ex-IT 2400-RP-SMA 28-001	
Manufacture	ProAnt	
Polarization	Vertical	
Gain / Imp.	+2.0 dBi / 50ohm @ 2.4 GHz	
Size	Ø 12 x 28 mm	
Connector	Reverse Polarity SMA plug (inner thread and pin receptacle)	
Comment	To be used together with the U.FL to RP-SMA adapter cable (cB-ACC-38)	
Approval	FCC, IC, R&TTE	

Part Number	cB-ACC-64	
Name	Ex-IT 2400-RP-SMA 70-002	
Manufacture	ProAnt	
Polarization	Vertical	
Gain / Imp.	+3.0 dBi / 50ohm @ 2.4 GHz	
Size	Ø 10 x 86 mm	

Connector	Reverse Polarity SMA plug (inner thread and pin receptacle)	
Comment	To be used together with the U.FL to RP-SMA adapter cable (cB-ACC-38)	
Approval	FCC, IC, R&TTE	

Part Number	cB-ACC-60	
Name	Ex-IT 2400-MHF 70-001	
Manufacture	ProAnt	
Polarization	Vertical	
Gain / Imp.	+3.0 dBi / 50ohm @ 2.4 GHz	
Size	Ø 10 x 70 mm	
Cable length	100 mm	
Connector	U.FL	
Comment	To be connected to the U.FL connector residing on the module	
Approval	FCC, IC, R&TTE	

Part Number	cB-ACC-81	
Name	InSide-WLAN Square (dual band)	
Manufacture	ProAnt	
Polarization	Vertical	
Gain / Imp.	+3.0 dBi / 50ohm @ 2.4 GHz +3.0 dBi / 50ohm @ 5 GHz	
Size	24 x 22 mm	
Cable length	100 mm	
Connector	U.FL	
Comment	To be connected to the U.FL connector residing on the module	
Approval	FCC, IC, R&TTE	

Part Number	N/A	
--------------------	------------	--

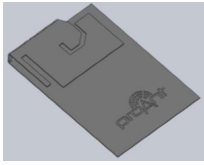
Name	InSide Fold WLAN (dual band)	
Manufacture	ProAnt	
Polarization	Vertical	
Gain / Imp.	+2.5 dBi / 50ohm @ 2.4 GHz +3.5 dBi / 50ohm @ 5 GHz	
Size	35 x 25 x 3.3 mm	
Cable length	100 mm	
Connector	U.FL	
Comment	To be connected to the U.FL connector residing on the module	
Approval	FCC, IC, R&TTE	

Part Number	cB-ACC-55	
Name	InSide-WLAN (dual band)	
Manufacture	ProAnt	
Polarization	Vertical	
Gain / Imp.	+3.0 dBi / 50ohm @ 2.4 GHz +3.0 dBi / 50ohm @ 5 GHz	
Size	27 x 12 mm (triangular)	
Cable length	100 mm	
Connector	U.FL	
Comment	To be connected to the U.FL connector residing on the module	
Approval	FCC, IC, R&TTE	

Part Number	cB-ACC-67	
-------------	-----------	--

Name	OutSide-2400	
Manufacture	ProAnt	
Polarization	Vertical	
Gain / Imp.	+3.0 dBi / 50ohm @ 2.4 GHz	
Size	36 x 18 x 16 mm	
Cable length	70 mm	
Connector	U.FL	
Comment	To be connected to the U.FL connector residing on the module	
Approval	FCC, IC, R&TTE	

Part Number	cB-ACC-66	
Name	FlatWhip 2400	
Manufacture	ProAnt	
Gain / Imp.	+3.0 dBi / 50ohm @ 2.4 GHz	
Size	Ø 50.0 x 30.0 mm	
Connector	SMA plug (inner thread and pin)	
Comment	To be used together with the U.FL to SMA adapter cable (cB-ACC-18 or cB-ACC-48)	
Approval	R&TTE	

4.3.2 Alternative antennas

The alternative antennas are available for backward compatibility but not recommended for new designs.

Part Number	cB-ACC-54	
--------------------	------------------	--

Name	Ex-IT WLAN SMA (dual-band)	
Manufacture	ProAnt	
Polarization	Vertical	
Gain / Imp.	+3.0 dBi / 50ohm @ 2.4 GHz +3.0 dBi / 50ohm @ 5 GHz	
Size	Ø 10 x 107 mm	
Connector	SMA plug (inner thread and pin)	
Comment	To be used together with the U.FL to SMA adapter cable (cB-ACC-18 or cB-ACC-48)	
Approval	R&TTE	

Part Number	N/A	
Name	Ex-IT 2400-SMA 28-001	
Manufacture	ProAnt	
Polarization	Vertical	
Gain / Imp.	+2.0 dBi / 50ohm @ 2.4 GHz	
Size	Ø 12 x 28 mm	
Connector	SMA plug (inner thread and pin)	
Comment	To be used together with the U.FL to SMA adapter cable (cB-ACC-18 or cB-ACC-48)	
Approval	R&TTE	

Part Number	N/A	
Name	Ex-IT 2400-SMA 70-002	
Manufacture	ProAnt	
Polarization	Vertical	
Gain / Imp.	+3.0 dBi / 50ohm @ 2.4 GHz	
Size	Ø 10 x 86 mm	

Connector	SMA plug (inner thread and pin)	
Comment	To be used together with the U.FL to SMA adapter cable (cB-ACC-18 or cB-ACC-48)	
Approval	R&TTE	

Part Number	cB-ACC-57	
Name	InSide 2400	
Manufacture	ProAnt	
Polarization	Vertical	
Gain / Imp.	+3.0 dBi / 50ohm @ 2.4 GHz	
Size	27 x 12 mm (triangular)	
Cable length	100 mm	
Connector	U.FL	
Comment	To be connected to the U.FL connector residing on the module	
Approval	FCC, IC, R&TTE	

5 Mounting Information

5.1 Module Dimensions

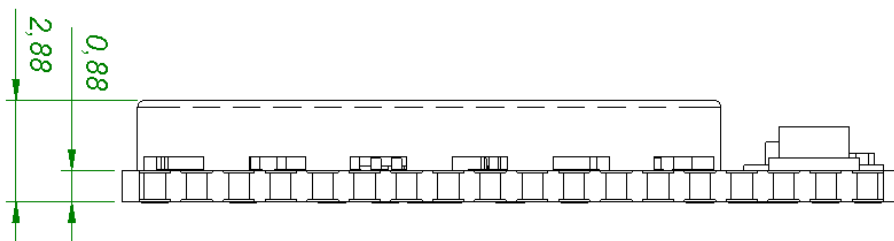
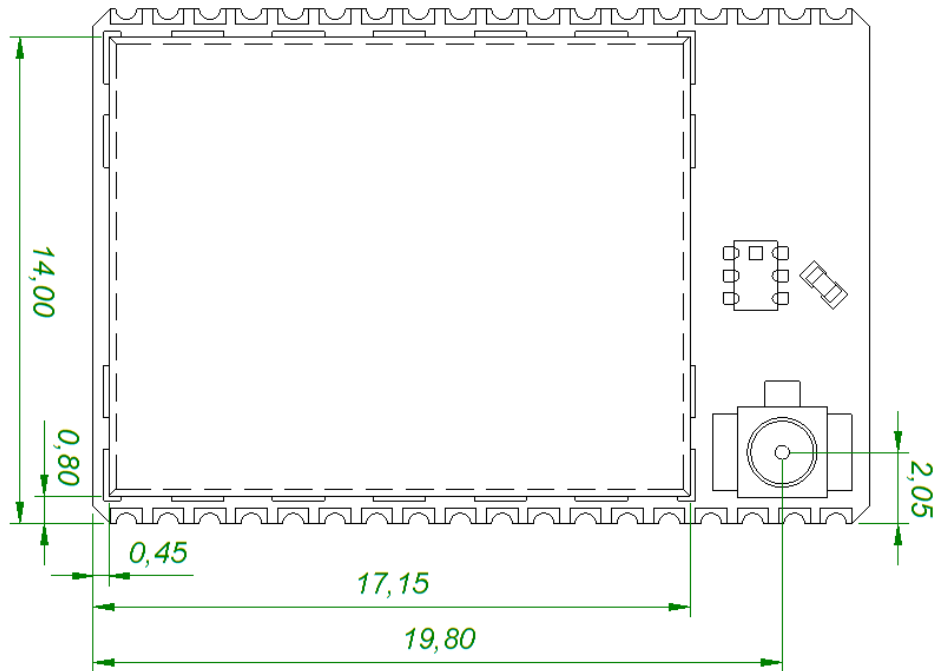

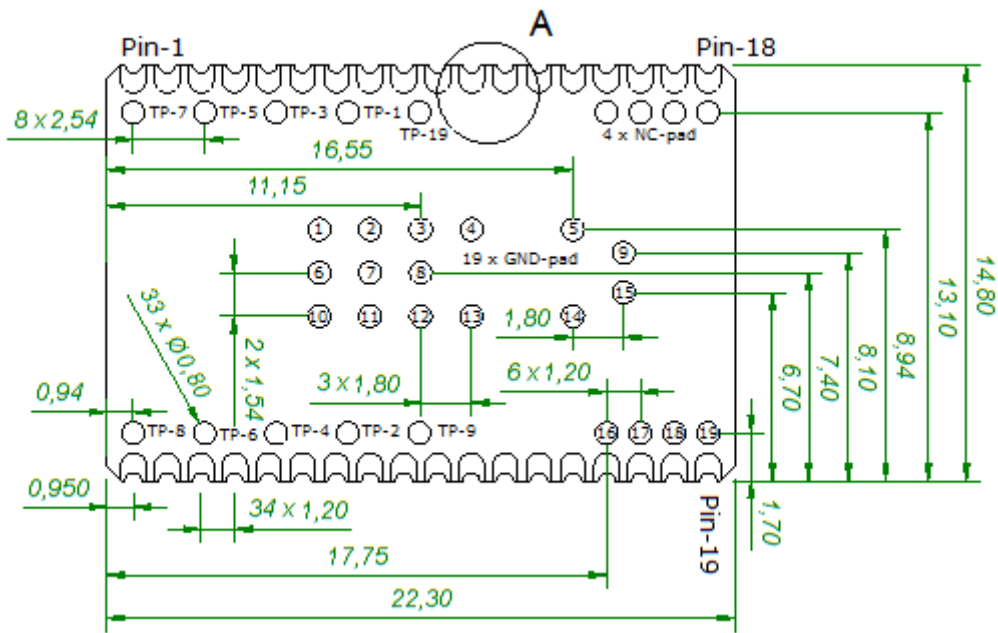
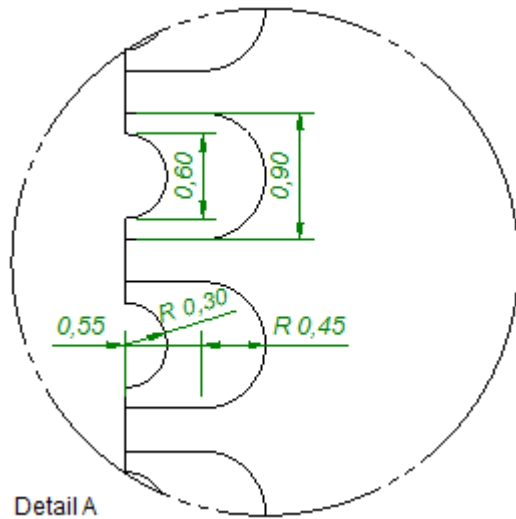

Tolerances:

1. Outline dimensions +/- 0.2mm

5.2 PCB Solder Lands

5.2.1 Host Board

The host PCB footprint should not contain any traces or vias under the module except the pads connecting to the solder lands of connector J4- and the 19 supplementary GND-pads. TP- and NC-pads are not mandatory but can be used to get a better balance of the solder process.

5.2.2 Mounting Process

Although connectBlue devices will withstand two re-flow soldering processes ($T_{\max} < 250^{\circ}\text{C}$) we strongly recommend the modules not being subjected to more than one soldering process after being shipped from connectBlue thus the modules are populated on the host product in the final solder processing step.

- The PCB in our modules is UL recognized ZPMV2 min. 130 °C flame class V-0 with ENIG coated solder lands.
- The modules are produced in a lead-free process with a lead-free soldering paste.
- It is recommended that the customers make their own electrical, climate, stress and vibration tests on the final assembled product to secure that the manufacturing process hasn't damaged or affected the module in any way.
- The modules are delivered in ESD bags (for small quantities) or tape-on-reel
 - Modules delivered on tape-on-reel are packaged in sealed drypack" bags, MSL-3
 - Modules delivered in ESD bag are not in a sealed drypack
- The device recommended maximum re-flow temperature is 245°C for 10 sec.
- The device absolute maximum re-flow temperature is 250°C for 3 sec.

6 Regulatory Information

6.1 CE compliance

6.1.1 Equipment classes

Depending on which frequency bands this multi-radio module can operate in it is defined as either class-1 or class-2 radio equipment. The End-product that utilise the module inherits the equipment class of the module.

- Class-1 radio equipment can be placed on the market and put into service without restrictions. (article 1 of Commission Decision 2000/299/EC of April 6 2000)
- Class-2 radio equipment is equipment for which Member States apply restrictions as indicated in Article 1(2) of the Decision, which also assigns the "Alert Sign" as "Equipment Class Identifier" for this class.

This multi-radio module is defined as class-1 radio equipment when it is restricted to operate in the following frequency bands:

- Bluetooth *classic*, ISM band 2400 – 2483.5 MHz
- Bluetooth *Low Energy*, ISM band 2400 – 2483.5 MHz
- WLAN, ISM band 2400 – 2483.5 MHz
- WLAN, U-NII band-2e 5470 – 5725 MHz

If the end product allows the multi radio module to be operated in the band 5150 – 5350 MHz (WLAN channel: 36 – 64) it is defined as class-2 radio equipment and must be marked accordingly.

Class-2 radio equipment must have the "alert" sign affixed on the equipment, packaging and printed in the user instruction manual.



 Guidance on how the End product that utilise this module is marked in accordance with the R&TTE directive is found in the following links:

http://ec.europa.eu/enterprise/sectors/rtte/documents/index_en.htm#h2-5

http://ec.europa.eu/enterprise/sectors/rtte/documents/guidance/index_en.htm

A direct link to the quick guide to the marking requirements can be found here:

http://ec.europa.eu/enterprise/sectors/rtte/files/guidance/guidance_en.pdf

The ODIN-W160 uses harmonised frequency bands thus it is comprised by subclass H01 of class 2 equipment, for which notification in accordance with article 6(4) of the R&TTE directive is not necessary.

A definition of subclasses of Class 2 equipment can be found in the following link:

http://ec.europa.eu/enterprise/sectors/rtte/files/rtte-subclass2_en.pdf

The table below shows the restrictions when operating the module in WLAN mode within the European countries

band	Channel number	Channel frequency	Indoor Use allowed	Outdoor Use allowed	Radio Equipment Class
ISM	1 - 13	2412 - 2472 MHz	Yes	Yes	1
U-NII 1	36 - 48	5180 - 5240 MHz	Yes	No	2
U-NII 2	52 - 64	5260 - 5320 MHz	Yes	No	2
U-NII 2e	100 - 140	5500 - 5700 MHz	Yes	Yes	1
U-NII 3	149 - 165	5745 - 5825 MHz	No	No	-

6.1.2 Declaration of Conformity



We, connectBlue AB, of
Norra Vallgatan 64 3V
SE-211 22 Malmö, Sweden

declare under our sole responsibility that our product:

- ODIN-W160

to which this declaration relates, conforms to the following product specifications:

R&TTE Directive 1999/5/EC

Effective use of frequency spectrum:

- EN 300 328 V1.8.1 (2012-06)
- EN 301 893 V1.7.1 (2012-06)

EMC:

- EN 301 489-1 V1.9.2 (2011-09)
- EN 301 489-17 V2.2.1 (2012-09)
- EN 61000-6-2 (2005)

Health and safety:

- EN 60950-1:2006 + A11:2009
- IEC 60950-1:2005
- EN 62311:2008 (WLAN)
- EN 62479:2010 (BT + BLE)

Medical Electrical Equipment

- IEC 60601-1-2 : 2007

6.2 IC and FCC compliance

6.2.1 IC compliance

This device complies with Industry Canada licence-exempt RSS standard(s). Operation is subject to the following two conditions:

1. this device may not cause interference, and
2. this device must accept any interference, including interference that may cause undesired operation of the device.

Under Industry Canada regulations, this radio transmitter may only operate using an antenna of a type and maximum (or lesser) gain approved for the transmitter by Industry Canada. To reduce potential radio interference to other users, the antenna type and its gain should be so chosen that the equivalent isotropically radiated power (e.i.r.p.) is not more than that necessary for successful communication.

The device for operation in the band 5150-5250 MHz is only for indoor use to reduce the potential for harmful interference to co-channel mobile satellite systems; the maximum antenna gain permitted for devices in the bands 5250-5350 MHz and 5470-5725 MHz shall comply with the e.i.r.p. limit; and the maximum antenna gain permitted for devices in the band 5725-5825 MHz shall comply with the e.i.r.p. limits specified for point-to-point and non point-to-point operation as appropriate.

Operation in the 5600-5650 MHz band is not allowed in Canada. High-power radars are allocated as primary users (i.e. priority users) of the bands 5250-5350 MHz and 5650-5850 MHz and that these radars could cause interference and/or damage to LE-LAN devices.

This equipment complies with IC RSS-102 radiation exposure limits set forth for an uncontrolled environment. This equipment should be installed and operated with minimum distance 20 cm between the radiator & your body.

6.2.2 Conformité aux normes d'IC

Cet appareil est conforme à la(aux) norme(s) RSS sans licence d'Industry Canada. Son utilisation est soumise aux deux conditions suivantes :

1. Cet appareil ne doit pas causer d'interférences et
2. il doit accepter toutes interférences reçues, y compris celles susceptibles d'avoir des effets indésirables sur son fonctionnement.

Conformément aux réglementations d'Industry Canada, cet émetteur radio ne peut fonctionner qu'à l'aide d'une antenne dont le type et le gain maximal (ou minimal) ont été approuvés pour cet émetteur par Industry Canada. Pour réduire le risque d'interférences avec d'autres utilisateurs, il faut choisir le type d'antenne et son gain de telle sorte que la puissance isotrope rayonnée équivalente (p.i.r.e) ne soit pas supérieure à celle requise pour obtenir une communication satisfaisante.

Le dispositif de fonctionnement dans la bande 5150-5250 MHz est réservé à une utilisation en intérieur pour réduire le risque d'interférences nuisibles à la co-canal systèmes mobiles par satellite, le gain d'antenne maximal autorisé pour les appareils dans les bandes 5250-5350 MHz et 5470-5725 MHz doit se conformer à la pire limite, et le gain d'antenne maximal autorisé pour les appareils dans la bande 5725-5825 MHz doivent être conformes avec le pire limites spécifiées à point-à-ponctuelles et non point-à-point de fonctionnement selon qu'il convient.

Opération dans la bande 5600-5650 MHz n'est pas autorisée au Canada. Haute puissance radars sont désignés comme utilisateurs principaux (c.-à-utilisateurs prioritaires) des bandes 5250-5350 MHz et 5650-5850 MHz et que ces radars pourraient causer des interférences et / ou des dommages à dispositifs LAN-EL.

Cet équipement respecte les limites d'exposition aux rayonnements IC RSS-102 définies pour un environnement non contrôlé. Il doit être installé et utilisé en maintenant une distance minimum de 20 cm entre le radiateur et votre corps.

6.2.3 FCC statement

This device complies with Part 15 of the FCC Rules. Operation is subject to the following two conditions:

1. this device may not cause harmful interference, and
2. this device must accept any interference received, including interference that may cause undesired operation.



This equipment has been tested and found to comply with the limits for a Class B digital device, pursuant to Part 15 of the FCC Rules. These limits are designed to provide reasonable protection against harmful interference in a residential installation. This equipment generates, uses and can radiate radio frequency energy and, if not installed and used in accordance with the instructions, may cause harmful interference to radio communications. However, there is no guarantee that interference will not occur in a particular installation. If this equipment does cause harmful interference to radio or television reception, which can be determined by turning the equipment off and on, the user is encouraged to try to correct the interference by one or more of the following measures:

- Reorient or relocate the receiving antenna
- Increase the separation between the equipment and receiver
- Connect the equipment into an outlet on a circuit different from that to which the receiver is connected

Consult the dealer or an experienced radio/TV technician for help.

6.2.3.1 End product labelling requirements

For an end product using the product ODIN-W160 there MUST be a label containing, at least, the following information:

This device contains
FCC ID: PVH0953
IC: 5325A-0953

The label must be affixed on an exterior surface of the end product such that it will be visible upon inspection in compliance with the modular approval guidelines developed by the FCC.

6.2.3.1.1 FCC end product labelling

In accordance with 47 CFR § 15.19 the end product shall bear the following statement in a conspicuous location on the device:

"This device complies with Part 15 of the FCC Rules. Operation is subject to the following two conditions:

1. this device may not cause harmful interference, and
2. this device must accept any interference received, including interference that may cause undesired operation."

When the device is so small or for such use that it is not practicable to place the statement above on it, the information shall be placed in a prominent location in the instruction manual or pamphlet supplied to the user or, alternatively, shall be placed on the container in which the device is marketed. However, the FCC ID label must be displayed on the device.

In case, where the final product will be installed in locations where the end-consumer is not able to see the FCC ID and/or this statement, the FCC ID and the statement shall also be included in the end-product manual.

6.2.3.1.2 IC end product labelling

User manuals for licence-exempt LPDs shall contain the following or equivalent statements in a conspicuous position:

Operation is subject to the following two conditions:

1. this device may not cause interference, and
2. this device must accept any interference, including interference that may cause undesired operation of the device.

6.2.3.1.3 Étiquetage du produit final conforme à IC

Les manuels d'utilisation d'appareils de faible puissance, sans licence, feront figurer à un endroit bien visible les mentions suivantes ou équivalentes:

Son utilisation est soumise aux deux conditions suivantes:

1. Cet appareil ne doit pas causer d'interférences et
2. il doit accepter toutes interférences reçues, y compris celles susceptibles d'avoir des effets indésirables sur son fonctionnement.

6.2.3.2 Antenna

Our module ODIN-W160 is for OEM integrations only.
The module must in the end-product be installed in such manner that only the authorized antennas can be used.

6.2.3.3 Caution

 Any changes or modifications NOT explicitly APPROVED by connectBlue AB could cause the module to cease to comply with FCC rules part 15, and thus void the user's authority to operate the equipment.

 Within the frequency band 5150 to 5250 MHz the module type ODIN-W160 is restricted to indoor operations to reduce any potential for harmful interference to co-channel MSS operation.

 §15.407 statement; in case of absence of information to transmit or operational failure the module types ODIN-W160 will automatically discontinue transmission.

6.2.3.4 RF-exposure statement

This equipment complies with FCC radiation exposure limits set forth for an uncontrolled environment. This equipment should be installed and operated with minimum distance 20 cm between the radiator & your body.

This equipment complies with IC RSS-102 radiation exposure limits set forth for an uncontrolled environment. This equipment should be installed and operated with minimum distance 20 cm between the radiator & your body.

Cet équipement est conforme aux limites d'exposition de rayonnement d'IC RSS-102 déterminées pour un environnement non contrôlé. Cet équipement devrait être installé et actionné avec la distance minimum 20 cm entre le radiateur et votre corps.

Any notification to the end user of installation or removal instructions about the integrated radio module is NOT allowed

6.3 Compliance with RoHS Directive



The ODIN-W160 are produced according to the RoHS (Restriction of the use of certain Hazardous Substances in electrical and electronic equipment) directive and complies with the directive.

7 Guidelines for Efficient and Safe Use

7.1 General

Read this information before using your ODIN-W160 module.

For any exceptions, due to national requirements or limitations, when using your WLAN module, please contact connectBlue AB.



Changes or modifications to the product not expressly approved by connectBlue AB will void the user's authority to operate the equipment.

7.2 Product Care

- Do not expose your product to liquid or moisture.
- Do not expose your product to extreme hot or cold temperature.
- Do not expose your product to lit candles, cigarettes, cigars, open flames, etc.
- Do not drop, throw or try to bend your product since rough treatment could damage your product.
- Do not attempt to disassemble your product. Doing so will void warranty. The product does not contain consumer serviceable or replaceable components. Service should only be performed by connectBlue AB.
- Do not paint your product as the paint could prevent normal use.
- If your product is not to be used for a longer period, store it in a dry place free from damp, dust and not subjected to extreme temperatures.
- The clearance and creepage distances required by the end product must be withheld when the module is installed.
- The cooling of the end product shall not negatively be influenced by the installation of the module when the module is installed.

7.3 Radio Frequency Exposure

The ODIN-W160 WLAN module contains a small radio transmitter and receiver.

During communication with other WLAN products the ODIN-W160 module transmits and receives radio frequency (RF) electromagnetic fields (microwaves) in the frequency range 2412 - 2462 MHz, 5180 - 5240 MHz, 5260 - 5320 MHz, and 5500 - 5700 MHz.

The output power of the radio transmitter is very low.

When using the module, you will be exposed to some of the transmitted RF energy. This exposure is well below the prescribed limits in all national and international RF safety standards and regulations.

7.4 Electronic Equipment

Most modern electronic equipment, for example, in hospitals and cars, is shielded from RF energy. However, certain electronic equipment is not. Therefore:



This equipment emits RF energy. Please insure that all medical devices used in proximity to this device meet appropriate susceptibility specifications for this type of RF energy.

7.5 Potentially Explosive Atmospheres

Turn off your electronic device before entering an area with potentially explosive atmosphere. It is rare, but your electronic device could generate sparks. Sparks in such areas could cause an explosion or fire resulting in bodily injury or even death.

Areas with a potentially explosive atmosphere are often, but not always, clearly marked. They include fueling areas, such as petrol station, below deck on boats, fuel or chemical transfer or storage facilities, and areas where the air contains chemicals or particles, such as grain, dust, or metal powders.

7.6 Safety Compliance

In order to fulfil the safety standard EN 60950-1:2006 the WLAN module ODIN-W160 must be supplied by a Class-2 Limited Power Source.