



# SARA-R4/N4 series

LTE Cat M1 / NB1 and EGPRS modules

Data Sheet



## Abstract

Technical data sheet describing the size-optimized SARA-R4/N4 series LTE Cat M1 / NB1 and EGPRS cellular modules. The modules are a complete and cost efficient solution offering multi band data transmissions for Low Power Wide Area solutions in a compact form factor.

# Document Information

<b>Title</b>	<b>SARA-R4/N4 series</b>	
<b>Subtitle</b>	LTE Cat M1/NB1 and EGPRS modules	
<b>Document type</b>	Data Sheet	
<b>Document number</b>	UBX-16024152	
<b>Revision and date</b>	R11	09-May-2018
<b>Disclosure Restriction</b>		

<b>Product status</b>	<b>Corresponding content status</b>	
<b>Functional Sample</b>	Draft	For functional testing. Revised and supplementary data will be published later.
<b>In Development / Prototype</b>	Objective Specification	Target values. Revised and supplementary data will be published later.
<b>Engineering Sample</b>	Advance Information	Data based on early testing. Revised and supplementary data will be published later.
<b>Initial Production</b>	Early Production Information	Data from product verification. Revised and supplementary data may be published later.
<b>Mass Production / End of Life</b>	Production Information	Document contains the final product specification.

This document applies to the following products:

<b>Product name</b>	<b>Type number</b>	<b>Modem version</b>	<b>Application version</b>	<b>PCN reference</b>	<b>Product status</b>
SARA-R404M	SARA-R404M-00B-00	K0.0.00.00.07.06		UBX-17047084	Initial Production
SARA-R410M	SARA-R410M-01B-00	L0.0.00.00.02.03		UBX-17051617	Initial Production
	SARA-R410M-02B-00	L0.0.00.00.05.06	A02.00	UBX-18010263	Initial Production
SARA-R412M	SARA-R412M-02B-00	M0.03.00	A01.03	UBX-18006467	Prototype
SARA-N410	SARA-N410-02B-00				Functional Sample

u-blox or third parties may hold intellectual property rights in the products, names, logos and designs included in this document. Copying, reproduction, modification or disclosure to third parties of this document or any part thereof is only permitted with the express written permission of u-blox.

The information contained herein is provided "as is" and u-blox assumes no liability for its use. No warranty, either express or implied, is given, including but not limited to, with respect to the accuracy, correctness, reliability and fitness for a particular purpose of the information. This document may be revised by u-blox at any time without notice. For the most recent documents, visit [www.u-blox.com](http://www.u-blox.com).

Copyright © u-blox AG.

# Contents

<b>Document Information</b> .....	<b>2</b>
<b>Contents</b> .....	<b>3</b>
<b>1 Functional description</b> .....	<b>5</b>
1.1 Overview .....	5
1.2 Product features .....	5
1.3 Block diagram .....	6
1.4 Product description .....	7
1.5 AT command support .....	8
1.6 Supported features .....	9
<b>2 Interfaces</b> .....	<b>9</b>
2.1 Power management .....	10
2.1.1 Module supply input (VCC) .....	10
2.1.2 Generic digital interfaces supply output (V_INT) .....	10
2.2 Antenna interface .....	10
2.2.1 Antenna RF interface (ANT) .....	10
2.2.2 Antenna detection (ANT_DET) .....	10
2.3 System functions .....	11
2.3.1 Module power-on .....	11
2.3.2 Module power-off .....	11
2.3.3 Module reset .....	11
2.4 SIM .....	11
2.4.1 SIM interface .....	11
2.4.2 SIM detection .....	11
2.5 Serial communication .....	12
2.5.1 UART interface .....	12
2.5.2 USB interface .....	13
2.5.3 SPI interface .....	13
2.5.4 SDIO interface .....	14
2.5.5 DDC (I <sup>2</sup> C) interface .....	14
2.6 Audio .....	14
2.7 GPIO .....	15
<b>3 Pin definition</b> .....	<b>16</b>
3.1 Pin assignment .....	16
<b>4 Electrical specifications</b> .....	<b>20</b>
4.1 Absolute maximum rating .....	20
4.1.1 Maximum ESD .....	20
4.2 Operating conditions .....	21
4.2.1 Operating temperature range .....	21
4.2.2 Thermal parameters .....	21
4.2.3 Supply/power pins .....	22

4.2.4	Current consumption.....	23
4.2.5	LTE RF characteristics .....	24
4.2.6	2G RF characteristics .....	26
4.2.7	ANT_DET pin characteristics.....	26
4.2.8	PWR_ON pin.....	27
4.2.9	RESET_N pin.....	27
4.2.10	SIM pins .....	27
4.2.11	USB pins .....	28
4.2.12	Generic Digital Interfaces pins .....	28
4.2.13	DDC (I <sup>2</sup> C) pins.....	28
<b>5</b>	<b>Mechanical specifications .....</b>	<b>29</b>
<b>6</b>	<b>Qualification and approvals.....</b>	<b>30</b>
6.1	Reliability tests.....	30
6.1.1	Approvals.....	30
<b>7</b>	<b>Product handling &amp; soldering.....</b>	<b>31</b>
7.1	Packaging .....	31
7.1.1	Reels .....	31
7.1.2	Tapes.....	32
7.2	Moisture Sensitivity Levels.....	33
7.3	Reflow soldering .....	33
7.4	ESD precautions.....	33
<b>8</b>	<b>Labeling and ordering information .....</b>	<b>34</b>
8.1	Product labeling.....	34
8.2	Explanation of codes .....	34
8.3	Ordering information.....	35
	<b>Appendix .....</b>	<b>36</b>
<b>A</b>	<b>Glossary .....</b>	<b>36</b>
	<b>Related documents .....</b>	<b>39</b>
	<b>Revision history .....</b>	<b>40</b>
	<b>Contact.....</b>	<b>41</b>

# 1 Functional description

## 1.1 Overview

SARA-R4/N4 series modules are an LTE Cat M1, LTE Cat NB1 and EGPRS multi-mode solution in the miniature SARA LGA form factor (26.0 x 16.0 mm, 96-pin). They allow an easy integration into compact designs and a seamless drop-in migration from other u-blox cellular module families.

SARA-R4/N4 series modules provide software-based multi-band configurability enabling world-wide global coverage in LTE Cat M1 / NB1 and (E)GPRS / GSM radio access technologies.

Variants specifically designed to operate in LTE Cat NB1 only, or in LTE Cat M1 band 13 only, or in LTE Cat M1 bands 2, 4, 5 and 12 only are also available.

SARA-R4/N4 series modules offer data communications up to 375 kbit/s over an extended operating temperature range of -40 °C to +85 °C, with low power consumption, and with coverage enhancement for deeper range into buildings and basements (and underground with NB1).

With many interface options and an integrated IP stack, SARA-R4/N4 series modules are the optimal choice for LPWA applications with low to medium data throughput rates, as well as devices that require long battery lifetimes, such as used in smart metering, smart lighting, telematics, asset tracking, remote monitoring, alarm panels, and connected health.

Customers can future-proof their solutions by means of Over-The-Air firmware updates, thanks to the uFOTA client/server solution that utilizes LWM2M, a light and compact protocol ideal for IoT applications.

SARA-R4/N4 series modules will also support VoLTE over Cat M1. The flexibility extends further through dynamic mode selection as M1-only/preferred or NB1-only/preferred.

## 1.2 Product features

Model	Region	Bands	Positioning	Interfaces	Audio	Features	Grade
		3GPP Release Baseline 3GPP LTE category LTE FDD bands GSM/(E)GPRS 4-band	GNSS via modem AssistNow software CellLocate®	UART USB 2.0 SPI SDIO DDC (I <sup>2</sup> C) GPIOs	Analog audio Digital audio	Power Saving Mode eDRX Antenna supervisor Embedded TCP/UDP stack Embedded HTTP, FTP Dual stack IPv4/IPv6 FW update over the air (FOTA)	Standard Professional Automotive
SARA-R404M	USA	13 M1 13		• • • • •		• • • • • • •	•
SARA-R410M-01B	North America	13 M1 2,4 5,12		• • • • •		• • • • • • •	•
SARA-R410M-02B	Global	13 M1 NB1 *	• • ○	• • ○ ○ • •	○	• • • • • • •	•
SARA-R412M-02B	Global	13 M1 NB1 •	• • ○	• • ○ ○ • •	○	• • • • • • •	•
SARA-N410-02B	Global	13 NB1 *	• • ○	• • ○ ○ • •		• • • • • • •	•

\* = Bands 1, 2, 3, 4, 5, 8, 12, 13, 17, 18, 19, 20, 25, 26, 28 (and band 39 in M1-only)

• = supported by all FW versions    ○ = supported by future FW versions

**Table 1: SARA-R4/N4 series main features summary**

## 1.3 Block diagram

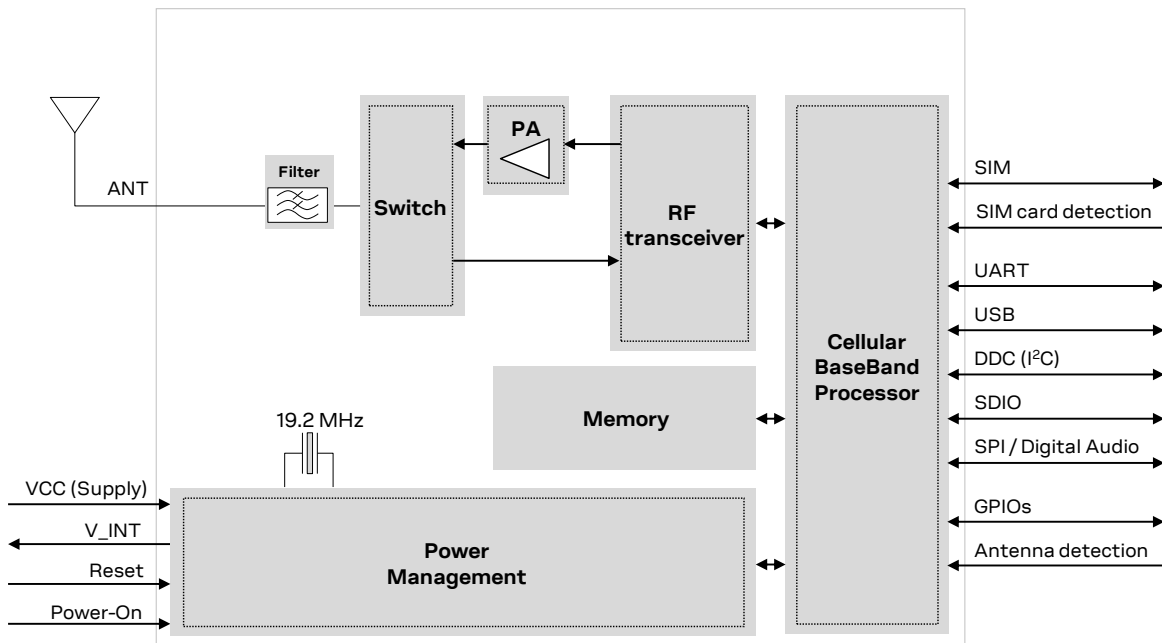



Figure 1: SARA-R4/N4 series block diagram

 SARA-R404M-00B and SARA-R410M-01B modules, i.e. the “00” and “01” product versions of the SARA-R4/N4 series modules, do not support the following interfaces, which should be left unconnected and should not be driven by external devices:

- DDC (I<sup>2</sup>C) interface
- SDIO interface
- SPI interface
- Digital audio interface

 SARA-R410M-02B, SARA-R412M-02B and SARA-N410-02B modules, i.e. the “02” product version of the SARA-R4/N4 series modules, do not support the following interfaces, which should be left unconnected and should not be driven by external devices:

- SDIO interface
- SPI interface
- Digital audio interface

## 1.4 Product description

SARA-R4/N4 series modules include the following variants / product versions:

- SARA-R404M LTE Cat M1 module,  
mainly designed for operation in LTE band 13
- SARA-R410M-01B LTE Cat M1 module,  
mainly designed for operation in LTE bands 2, 4, 5, 12
- SARA-R410M-02B LTE Cat M1 / NB1 module,  
mainly designed for operation in LTE bands 2, 3, 4, 5, 8, 12, 13, 20, 28
- SARA-R412M-02B LTE Cat M1 / NB1 and 2G module,  
mainly designed for operation in LTE bands 2, 3, 4, 5, 8, 12, 13, 20 and 2G Quad-band
- SARA-N410-02B LTE Cat NB1 module,  
mainly designed for operation in LTE bands 2, 4, 5, 12, 13

Item	SARA-R404M	SARA-R410M	SARA-R412M	SARA-N410
Protocol stack	3GPP Release 13	3GPP Release 13	3GPP Release 13	3GPP Release 13
RAT	LTE Cat M1 Half-Duplex	LTE Cat M1 Half-Duplex LTE Cat NB1 Half-Duplex <sup>1</sup>	LTE Cat M1 Half-Duplex LTE Cat NB1 Half-Duplex 2G GSM / GPRS / EGPRS	LTE Cat NB1 Half-Duplex
Bands	LTE FDD bands: Band 13 (750 MHz)	LTE FDD bands: Band 12 (700 MHz) Band 17 (700 MHz) <sup>1</sup> Band 28 (700 MHz) <sup>1</sup> Band 13 (750 MHz) <sup>1</sup> Band 20 (800 MHz) <sup>1</sup> Band 26 (850 MHz) <sup>1</sup> Band 18 (850 MHz) <sup>1</sup> Band 5 (850 MHz) Band 19 (850 MHz) <sup>1</sup> Band 8 (900 MHz) <sup>1</sup> Band 4 (1700 MHz) Band 3 (1800 MHz) <sup>1</sup> Band 2 (1900 MHz) Band 25 (1900 MHz) <sup>1</sup> Band 1 (2100 MHz) <sup>1</sup> LTE TDD bands: Band 39 (1900 MHz) <sup>2</sup>	LTE FDD bands: Band 12 (700 MHz) Band 17 (700 MHz) Band 28 (700 MHz) Band 13 (750 MHz) Band 20 (800 MHz) Band 26 (850 MHz) Band 18 (850 MHz) Band 5 (850 MHz) Band 19 (850 MHz) Band 8 (900 MHz) Band 4 (1700 MHz) Band 3 (1800 MHz) Band 2 (1900 MHz) Band 25 (1900 MHz) Band 1 (2100 MHz) LTE TDD bands: Band 39 (1900 MHz) <sup>2</sup> 2G bands: GSM 850 MHz E-GSM 900 MHz DCS 1800 MHz PCS 1900 MHz	LTE FDD bands: Band 12 (700 MHz) Band 17 (700 MHz) Band 28 (700 MHz) Band 13 (750 MHz) Band 20 (800 MHz) Band 26 (850 MHz) Band 18 (850 MHz) Band 5 (850 MHz) Band 19 (850 MHz) Band 8 (900 MHz) Band 4 (1700 MHz) Band 3 (1800 MHz) Band 2 (1900 MHz) Band 25 (1900 MHz) Band 1 (2100 MHz)
Power class	LTE Cat M1: Class 3 (23 dBm)	LTE Cat M1 / NB1 <sup>1</sup> : Class 3 (23 dBm)	LTE category M1 / NB1: Class 3 (23 dBm) 2G GMSK: Class 4 (33 dBm) for GSM/E-GSM bands Class 1 (30 dBm) for DCS/PCS bands 2G 8-PSK: Class E2 (27 dBm) for GSM/E-GSM bands Class E2 (26 dBm) for DCS/PCS bands	LTE category NB1: Class 3 (23 dBm)

<sup>1</sup> Not supported by the "01" product version.

<sup>2</sup> Supported in LTE category M1 only. Not supported by the "01" product version.

Item	SARA-R404M	SARA-R410M	SARA-R412M	SARA-N410
Data rate	LTE category M1: up to 375 kb/s UL up to 300 kb/s DL	LTE category M1: up to 375 kb/s UL up to 300 kb/s DL LTE category NB1 <sup>1</sup> : up to 62.5 kb/s UL up to 27.2 kb/s DL	LTE category M1: up to 375 kb/s UL up to 300 kb/s DL LTE category NB1: up to 62.5 kb/s UL up to 27.2 kb/s DL GPRS multi-slot class 33 <sup>3</sup> : Up to 85.6 kb/s UL Up to 107 kb/s DL EGPRS multi-slot class 33 <sup>3</sup> : Up to 236.8 kb/s UL Up to 296.0 kb/s DL	LTE category NB1: up to 62.5 kb/s UL up to 27.2 kb/s DL

**Table 2: SARA-R4/N4 series LTE Cat M1, LTE Cat NB1, EGPRS, GPRS and GSM characteristics**

## 1.5 AT command support

The SARA-R4/N4 series modules support AT commands according to the 3GPP standards TS 27.007 [4], TS 27.005 [5], TS 27.010 [6], and the u-blox AT command extension.

 For the complete list of all supported AT commands and their syntax, see the SARA-R4/N4 series AT Commands Manual [1].

<sup>3</sup> GPRS/EGPRS multi-slot class 33 implies a maximum of 5 slots in Down-Link and 4 slots in Up-Link with 6 slots in total.



## 1.6 Supported features

Table 3 lists some of the main features supported by SARA-R4/N4 series modules. For more details, see the SARA-R4/N4 series System Integration Manual [2] and the SARA-R4/N4 series AT Commands Manual [1].

Feature	Description
Network Indication	GPIO configured to indicate the network status: registered home network, registered roaming, data call enabled, no service. The feature can be enabled through the +UGPIOC AT command.
Antenna Detection	The <b>ANT_DET</b> pin provides antenna presence detection capability, evaluating the resistance from the <b>ANT</b> pin to GND by means of an external antenna detection circuit implemented on the application board. The antenna supervisor (i.e. antenna detection) feature can be enabled through the +UANTR AT command.
Embedded TCP and UDP stack	Embedded TCP/IP and UDP/IP stack including direct link mode for TCP and UDP sockets. Sockets can be set in Direct Link mode to establish a transparent end-to-end communication with an already connected TCP or UDP socket via the serial interface.
FTP	File Transfer Protocol functionality is supported via AT commands.
HTTP	Hyper-Text Transfer Protocol functionality is supported via AT commands.
Embedded SSL/TLS <sup>4</sup>	With the support of X.509 certificates, embedded SSL/TLS provides server and client authentication, data encryption, data signature and enables TCP/IP applications to communicate over a secured and trusted connection. The feature can be configured and enabled by the +USECMNG and +USECPRF AT commands.
MQTT <sup>5</sup>	Message Queuing Telemetry Transport is an ISO standard publish-subscribe messaging protocol designed for lightweight M2M communications over TCP. MQTT allows clients to communicate one-to-one, one-to-many and many-to-one over a long-lived outgoing TCP connection.
Dual stack IPv4/IPv6	Capability to move between IPv4 and dual stack network infrastructures. IPv4 and IPv6 addresses can be used.
Firmware update Over AT commands (FOAT)	Firmware module update over AT command interface. The feature can be enabled and configured through the +UFWUPD AT command.
Firmware update Over The Air (uFOTA)	u-blox firmware module update over the LTE air interface client/server solution using LWM2M.
GNSS via modem <sup>5</sup>	Full access to u-blox positioning chips and modules is available through a dedicated DDC (I <sup>2</sup> C) interface. This means that from any host processor, a single serial port can control the SARA-R4/N4 series cellular module and the u-blox positioning chip or module.
Power Saving Mode (PSM)	The Power Saving Mode (PSM) feature, defined in 3GPP Rel.13, allows further reduction of the module current consumption maximizing the amount of time a device can remain in PSM low power deep sleep mode during periods of data inactivity. It can be activated and configured by the +CPSMS AT command.
e-I-DRX <sup>6</sup>	Extended Idle mode DRX, based on 3GPP Rel.13, reduces the amount of signaling overhead decreasing the frequency of scheduled measurements and/or transmissions performed by the module in idle mode. This in turn leads to a reduction in the module power consumption while maintaining a perpetual connection with the base station.
Coverage Enhancements Mode A	Coverage Enhancements Mode A, introduced in 3GPP Rel.13, is used to improve cell signal penetration.
Coverage Enhancements Mode B <sup>7</sup>	Coverage Enhancements Mode B, introduced in 3GPP Rel.13, is used to further improve cell signal penetration.

Table 3: Some of the main features supported by SARA-R4/N4 series modules

## 2 Interfaces

<sup>4</sup> Not supported by “00” product version

<sup>5</sup> Not supported by “00” and “01” product versions

<sup>6</sup> The feature is disabled on “00” and “01” product versions due to network readiness

<sup>7</sup> Not supported by “00”, “01” and “02” product versions

## 2.1 Power management

### 2.1.1 Module supply input (VCC)

SARA-R4/N4 series modules must be supplied through the **VCC** pins by a DC power supply. Voltage must be stable, because during operation the current drawn from **VCC** may vary significantly, based on the power consumption profile of the LTE Cat M1, LTE Cat NB1 and the 2G radio access technologies (described in the SARA-R4/N4 series System Integration Manual [2]).

SARA-R412M modules provide separate supply inputs over the three **VCC** pins:

- **VCC** pins #52 and #53 represent the supply input for the internal RF Power Amplifier, demanding most of the total current drawn of the module when RF transmission is enabled during a call
- **VCC** pin #51 represents the supply input for the internal baseband Power Management Unit, demanding minor part of the total current drawn of the module when RF transmission is enabled during a call

The three **VCC** pins of SARA-R404M, SARA-R410M and SARA-N410 modules are internally connected to both the internal Power Amplifier and the internal baseband Power Management Unit.

It is important that the system power supply circuit is able to withstand the maximum pulse current during a transmit burst at maximum power level (see Table 12).

### 2.1.2 Generic digital interfaces supply output (V\_INT)

SARA-R4/N4 series modules provide a 1.8 V supply rail output on the **V\_INT** pin, which is internally generated when the module is switched on. The same voltage domain is used internally to supply the generic digital interfaces of the module. The **V\_INT** supply output can be used in place of an external discrete regulator.

## 2.2 Antenna interface

### 2.2.1 Antenna RF interface (ANT)

The **ANT** pin represents the RF antenna interface of the module, with a characteristic impedance of 50  $\Omega$ .

### 2.2.2 Antenna detection (ANT\_DET)

The **ANT\_DET** pin is an Analog to Digital Converter (ADC) input with a current source provided by SARA-R4/N4 series modules to sense the antenna presence (as an optional feature). It evaluates the resistance from the **ANT** pin to GND by means of an external antenna detection circuit implemented on the application board (for more details, see the u-blox SARA-R4/N4 series System Integration Manual [2] and the SARA-R4/N4 series AT Commands Manual [1]).

## 2.3 System functions

### 2.3.1 Module power-on

SARA-R4/N4 series can be switched on using the following procedure:

- Low level on the **PWR\_ON** pin, which is normally set high by an internal pull-up, for a valid time period when the applied **VCC** voltage is within the valid operating range (see sections 4.2.3 and 4.2.8). The **PWR\_ON** line has to be driven by open drain, open collector or contact switch.

### 2.3.2 Module power-off

SARA-R4/N4 series can be properly switched off, with storage of the current parameter settings and a clean network detach, in one of these ways:

- AT+CPWROFF command (see the SARA-R4/N4 series AT Commands Manual [1])
- Low pulse on the **PWR\_ON** pin for a valid time period (see section 4.2.8)

An abrupt shutdown occurs on SARA-R4/N4 series modules, without storage of the current parameter settings and without a clean network detach, when:

- the **VCC** supply drops below the extended operating range minimum limit
- a low level is applied on the **RESET\_N** pin, which is normally set high by an internal pull-up, for a valid time period (see section 4.2.9). **RESET\_N** line has to be driven by open drain, open collector or contact switch.

### 2.3.3 Module reset

SARA-R4/N4 series modules can be reset (re-booted) by:

- AT+CFUN command (see the SARA-R4/N4 series AT Commands Manual [1]). This causes an “internal” or “software” reset of the module. The current parameter settings are saved in the module’s non-volatile memory and a clean network detach is performed.

## 2.4 SIM

### 2.4.1 SIM interface

A SIM card interface is provided on the **VSIM**, **SIM\_IO**, **SIM\_CLK**, **SIM\_RST** pins: the high-speed SIM/ME interface is implemented as well as the automatic detection of the required SIM supporting voltage.

Both 1.8 V and 3 V SIM types are supported (1.8 V and 3 V). Activation and deactivation with an automatic voltage switch from 1.8 V to 3 V is implemented according to the ISO-IEC 7816-3 specifications. The SIM driver supports the PPS procedure for baud-rate selection, according to the values proposed by the SIM card/chip.

### 2.4.2 SIM detection

The **GPIO5** pin of SARA-R4/N4 series modules is a 1.8 V digital input which can be configured as an external interrupt to detect the SIM card presence, as intended to be properly connected to the mechanical switch of an external SIM card holder. For more details, see the SARA-R4/N4 series System Integration Manual [2] and the SARA-R4/N4 series AT Commands Manual [1].

## 2.5 Serial communication

The SARA-R4/N4 series provides the following serial communication interfaces:

- UART interface: asynchronous serial interface available for the communication with a DTE host application processor (AT commands, data communication, FW update by means of FOAT)
- USB interface: High-Speed USB 2.0 compliant interface available for communications with a USB host application processor (AT commands, data communication, FW update by means of the FOAT feature), for FW update by means of the u-blox tool and for diagnostics
- SPI interface: Serial Peripheral Interface available for communications with an external compatible device
- SDIO interface: Secure Digital Input Output interface available for communications with a compatible device
- DDC interface: I<sup>2</sup>C bus compatible interface available for communications with external I<sup>2</sup>C devices

### 2.5.1 UART interface

SARA-R4/N4 series modules include a 9-wire unbalanced asynchronous serial interface (UART) for communication with an application host processor (AT commands and data communication).



The UART is available only if the USB is not enabled as AT command / data communication interface: UART and USB cannot be concurrently used for this purpose.

UART features are:

- Complete serial port with RS-232 functionality conforming to the ITU-T V.24 Recommendation [9], with CMOS compatible signal levels (0 V for low data bit or ON state and 1.8 V for high data bit or OFF state)
- Data lines (**RXD** as output, **TXD** as input), hardware flow control lines (**CTS** as output, **RTS** as input), modem status and control lines (**DTR** as input, **DSR** as output, **DCD** as output, **RI** as output) are provided
- The default baud rate is 115200 bit/s
- The default frame format is 8N1 (8 data bits, no parity, 1 stop bit)



Hardware flow control is not supported by the “00”, “01” and SARA-R410M-02B product versions, but the **RTS** input line needs to be set low (= ON state) to communicate over the UART interface on the “00” and “01” product versions.

The UART serial interface can be conveniently configured through AT commands. For more details, see the SARA-R4/N4 series AT Commands Manual [1] and the SARA-R4/N4 series System Integration Manual [2].

### Multiplexer protocol

SARA-R4/N4 series modules include multiplexer functionality as per 3GPP TS 27.010 [6] on the UART physical link.

This is a data link protocol which uses HDLC-like framing and operates between the module (DCE) and the application processor (DTE), allowing a number of simultaneous sessions over the physical link (UART).

The following virtual channels are defined:

- Channel 10: for Multiplexer control
- Channel 11: for all AT commands, and non-Dial Up Network (non-DUN) data connections. UDP, TCP data socket / data call connections through relevant AT commands.
- Channel 12: for Dial Up Network (DUN) data connection. It requires the host to have and use its own TCP/IP stack. The DUN can be initiated on the modem side or terminal/host side.
- Channel 13: for u-blox GNSS data tunneling (not supported by the “00” and “01” product versions).

## 2.5.2 USB interface

SARA-R4/N4 series modules include a high-speed USB 2.0 compliant interface with a maximum 480 Mbit/s data rate according to the USB 2.0 specification [10] representing the main interface for transferring high speed data with a host application processor. The module itself acts as a USB device and can be connected to any USB host equipped with compatible drivers.

The USB is the most suitable interface for transferring high speed data between SARA-R4/N4 series and a host processor, available for AT commands, data communication, FW upgrade by means of the FOAT feature, FW upgrade by means of the u-blox dedicated tool and for diagnostic purposes.

The **USB\_D+** / **USB\_D-** lines carry the USB data and signaling, while the **VUSB\_DET** pin represents the input to enable the USB interface by applying an external valid USB VBUS supply voltage (5.0 V typical).

 The USB interface is available as an AT command / data communication interface only if an external valid USB VBUS supply voltage (5.0 V typical) is applied at the **VUSB\_DET** input of the module since the switch-on of the module, and then held during normal operations. In this case, the UART will not be available.

 If the USB interface is enabled, the module does not enter the low power deep sleep mode: the external USB VBUS supply voltage needs to be removed from the **VUSB\_DET** input of the module to let it enter the Power Saving Mode defined in 3GPP Rel.13.

SARA-R4/N4 series modules provide by default a set of two USB functions:

- AT commands and data communication
- Diagnostic log

For more details regarding USB configurations / capabilities, see the SARA-R4/N4 series System Integration Manual [2].

## 2.5.3 SPI interface

 The SPI interface is not supported by the “00”, “01” and “02” product versions.

SARA-R4/N4 series modules include a Serial Peripheral Interface for communications with compatible external device.

The SPI interface can be made available as an alternative function, in a mutually exclusive way, over the digital audio interface pins (**I2S\_WA** / **SPI\_MOSI**, **I2S\_RXD** / **SPI\_MISO**, **I2S\_CLK** / **SPI\_CLK**, **I2S\_TXD** / **SPI\_CS**).

## 2.5.4 SDIO interface

 The SDIO interface is not supported by the “00”, “01” and “02” product versions.

SARA-R4/N4 series modules include a 4-bit Secure Digital Input Output interface (**SDIO\_D0**, **SDIO\_D1**, **SDIO\_D2**, **SDIO\_D3**, **SDIO\_CLK**, and **SDIO\_CMD**) designed to communicate with external compatible SDIO devices.

## 2.5.5 DDC (I<sup>2</sup>C) interface

 The DDC (I<sup>2</sup>C) interface is not supported by the “00” and “01” product versions.

SARA-R4/N4 series modules include an I<sup>2</sup>C-bus compatible DDC interface (**SDA**, **SCL**) available to communicate with a u-blox GNSS receiver and with external I<sup>2</sup>C devices as an audio codec: the SARA-R4/N4 series module acts as an I<sup>2</sup>C master that can communicate with I<sup>2</sup>C slaves in accordance with the I<sup>2</sup>C bus specifications [11].

The **SDA** and **SCL** pins have internal pull-up to **V\_INT**, so there is no need of additional pull-up resistors on the external application board.

## 2.6 Audio

 Audio is not supported by the “00”, “01” and “02” product versions.

SARA-R4/N4 series modules support VoLTE (Voice over LTE Cat M1 radio bearer) for providing audio services.

SARA-R4/N4 series modules include an I<sup>2</sup>S digital audio interface to transfer digital audio data to/from an external compatible audio device.

The digital audio interface can be made available as an alternative function, in a mutually exclusive way, over the SPI interface pins (**I2S\_WA / SPI\_MOSI**, **I2S\_RXD / SPI\_MISO**, **I2S\_CLK / SPI\_CLK**, **I2S\_TXD / SPI\_CS**).

## 2.7 GPIO

SARA-R4/N4 series modules include six pins (**GPIO1-GPIO6**) that can be configured as general purpose input/output or to provide custom functions as summarized in [Table 4](#) (for further details, see the SARA-R4/N4 series System Integration Manual [\[2\]](#) and the GPIO section of the SARA-R4/N4 series AT Commands Manual [\[1\]](#)).

Function	Description	Default GPIO	Configurable GPIOs
Network status indication	Network status: registered / data transmission, no service	--	GPIO1
GNSS supply enable <sup>8</sup>	Enable/disable the supply of a u-blox GNSS receiver connected to the cellular module by the DDC (I <sup>2</sup> C) interface	--	GPIO2
GNSS data ready <sup>8</sup>	Sense when a u-blox GNSS receiver connected to the module is ready for sending data by the DDC (I <sup>2</sup> C) interface	--	GPIO3
SIM card detection	SIM card physical presence detection	--	GPIO5
Module status indication	Module switched off or in PSM low power deep sleep mode, versus active or connected mode	--	GPIO1, GPIO2, GPIO3, GPIO4, GPIO5, GPIO6
General purpose input	Input to sense high or low digital level	--	GPIO1, GPIO2, GPIO3, GPIO4, GPIO5, GPIO6
General purpose output	Output to set the high or the low digital level	--	GPIO1, GPIO2, GPIO3, GPIO4, GPIO6
Pin disabled	Tri-state with an internal active pull-down enabled	GPIO1, GPIO2, GPIO3, GPIO4, GPIO5, GPIO6	GPIO1, GPIO2, GPIO3, GPIO4, GPIO5, GPIO6

**Table 4: GPIO custom functions configuration**

<sup>8</sup> Not supported by "00" and "01" product versions

## 3 Pin definition

### 3.1 Pin assignment

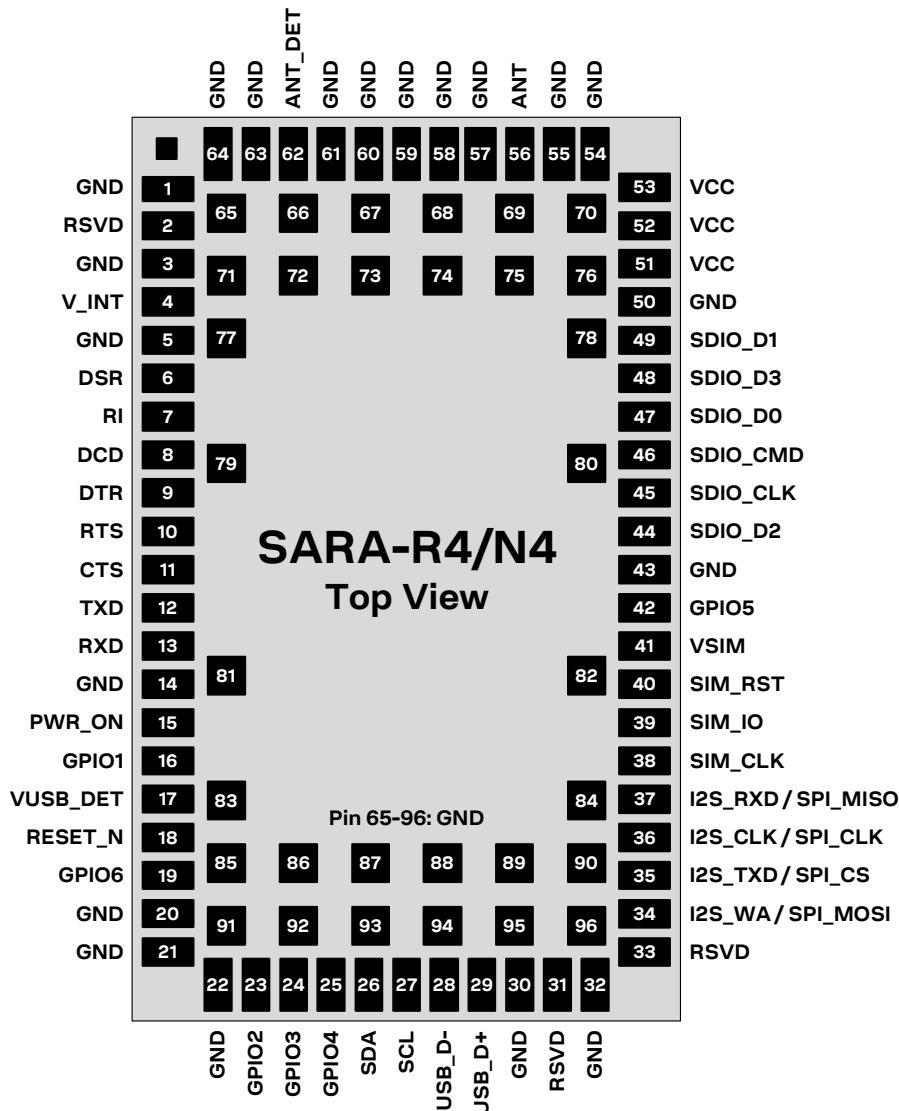

Figure 2: SARA-R4/N4 series pin assignment (top view)

No	Name	Power domain	I/O	Description	Remarks
1	GND	-	N/A	Ground	All the GND pins must be connected to ground
2	RSVD	-	N/A	RESERVED pin	Leave unconnected.
3	GND	-	N/A	Ground	All the GND pins must be connected to ground
4	V_INT	-	O	Generic Digital Interfaces supply output	V_INT = 1.8 V (typical) generated by the module when is switched on, outside low power PSM deep sleep mode. See section 4.2.3 for detailed electrical specs. Provide test point for diagnostic purposes.
5	GND	-	N/A	Ground	All the GND pins must be connected to ground
6	DSR	GDI	O	UART data set ready	Circuit 107 (DSR) in ITU-T V.24. See section 4.2.12 for detailed electrical specs.



No	Name	Power domain	I/O	Description	Remarks
7	RI	GDI	O	UART ring indicator	Circuit 125 (RI) in ITU-T V.24. See section 4.2.12 for detailed electrical specs.
8	DCD	GDI	O	UART data carrier detect	Circuit 109 (DCD) in ITU-T V.24. See section 4.2.12 for detailed electrical specs.
9	DTR	GDI	I	UART data terminal ready	Circuit 108/2 (DTR) in ITU-T V. 24. Internal active pull-up to V_INT. See section 4.2.12 for detailed electrical specs.
10	RTS	GDI	I	UART ready to send	Circuit 105 (RTS) in ITU-T V.24. Internal active pull-up to V_INT. Flow control is not supported by the "00", "01" and SARA-R410M-02B product versions See section 4.2.12 for detailed electrical specs.
11	CTS	GDI	O	UART clear to send	Circuit 106 (CTS) in ITU-T V.24. Flow control is not supported by the "00", "01" and SARA-R410M-02B product versions See section 4.2.12 for detailed electrical specs.
12	TXD	GDI	I	UART data input	Circuit 103 (TxD) in ITU-T V.24. Internal active pull-down to GND on "00", "02" versions Internal active pull-up to V_INT on "01" versions See section 4.2.12 for detailed electrical specs.
13	RXD	GDI	O	UART data output	Circuit 104 (RxD) in ITU-T V.24. See section 4.2.12 for detailed electrical specs.
14	GND	-	N/A	Ground	All the GND pins must be connected to ground
15	PWR_ON	POS	I	Power-on / power-off input	Internal 200 kΩ pull-up resistor. See section 4.2.8 for detailed electrical specs. Provide test point for diagnostic purposes.
16	GPIO1	GDI	I/O	GPIO	Configurable GPIO (see section 2.7). See section 4.2.12 for detailed electrical specs.
17	VUSB_DET	USB	I	USB detect input	Input for VBUS (5 V typical) USB supply sense. See section 4.2.11 for detailed electrical specs. Provide test point for diagnostic purposes.
18	RESET_N	ERS	I	External reset input	Internal 37 kΩ pull-up resistor to V_INT. See section 4.2.9 for detailed electrical specs. Provide test point for diagnostic purposes.
19	GPIO6	GDI	I/O	GPIO	Configurable GPIO (see section 2.7). See section 4.2.12 for detailed electrical specs.
20	GND	-	N/A	Ground	All the GND pins must be connected to ground
21	GND	-	N/A	Ground	All the GND pins must be connected to ground
22	GND	-	N/A	Ground	All the GND pins must be connected to ground
23	GPIO2	GDI	I/O	GPIO	Configurable GPIO (see section 2.7). See section 4.2.12 for detailed electrical specs.
24	GPIO3	GDI	I/O	GPIO	Configurable GPIO (see section 2.7). See section 4.2.12 for detailed electrical specs.
25	GPIO4	GDI	I/O	GPIO	Configurable GPIO (see section 2.7). See section 4.2.12 for detailed electrical specs.
26	SDA	DDC	I/O	I <sup>2</sup> C bus data line	Fixed open drain. Internal 2.2 kΩ pull-up resistor to V_INT. Not supported by "00" and "01" product versions See section 4.2.13 for detailed electrical specs.

No	Name	Power domain	I/O	Description	Remarks
27	SCL	DDC	O	I <sup>2</sup> C bus clock line	Fixed open drain. Internal 2.2 kΩ pull-up resistor to V <sub>INT</sub> . Not supported by “00” and “01” product versions See section 4.2.13 for detailed electrical specs.
28	USB_D-	USB	I/O	USB Data Line D-	90 Ω nominal differential impedance. Pull-up, pull-down and series resistors, as required by the USB 2.0 specifications [10], are part of the USB pin driver and shall not be provided externally. See section 4.2.11 for detailed electrical specs. Provide test point for diagnostic purposes.
29	USB_D+	USB	I/O	USB Data Line D+	90 Ω nominal differential impedance. Pull-up, pull-down and series resistors, as required by USB 2.0 specifications [10], are part of the USB pin driver and shall not be provided externally. See section 4.2.11 for detailed electrical specs. Provide test point for diagnostic purposes.
30	GND	-	N/A	Ground	All the GND pins must be connected to ground
31	RSVD	-	N/A	RESERVED pin	Leave unconnected.
32	GND	-	N/A	Ground	All the GND pins must be connected to ground
33	RSVD	-	N/A	RESERVED pin	This pin can be connected to GND.
34	I2S_WA / SPI_MOSI	GDI	O / O	I <sup>2</sup> S word alignment / SPI Master Output Slave Input	I <sup>2</sup> S word alignment, alternatively configurable as SPI Master Output Slave Input Not supported by “00”, “01” and “02” product versions See section 4.2.12 for detailed electrical specs.
35	I2S_TXD / SPI_CS	GDI	O / O	I <sup>2</sup> S transmit data / SPI Chip Select	I <sup>2</sup> S transmit data out, alternatively configurable as SPI Chip Select Not supported by “00”, “01” and “02” product versions See section 4.2.12 for detailed electrical specs.
36	I2S_CLK / SPI_CLK	GDI	O / O	I <sup>2</sup> S clock / SPI clock	I <sup>2</sup> S clock, alternatively configurable as SPI clock Not supported by “00”, “01” and “02” product versions See section 4.2.12 for detailed electrical specs.
37	I2S_RXD / SPI_MISO	GDI	I / I	I <sup>2</sup> S receive data / SPI Master Input Slave Output	I <sup>2</sup> S receive data input, alternatively configurable as SPI Master Input Slave Output Not supported by “00”, “01” and “02” product versions See section 4.2.12 for detailed electrical specs.
38	SIM_CLK	SIM	O	SIM clock	See section 4.2.10 for detailed electrical specs.
39	SIM_IO	SIM	I/O	SIM data	Internal 4.7 kΩ pull-up resistor to VSIM. See section 4.2.10 for detailed electrical specs.
40	SIM_RST	SIM	O	SIM reset	See section 4.2.10 for detailed electrical specs.
41	VSIM	-	O	SIM supply output	VSIM = 1.80 V typical or 2.95 V typical generated by the module according to the external SIM card type. See section 4.2.3 for detailed electrical specs.
42	GPIO5	GDI	I	SIM detection	SIM card presence detection input, alternatively configurable as GPIO (see section 2.7). See section 4.2.12 for detailed electrical specs.
43	GND	-	N/A	Ground	All the GND pins must be connected to ground
44	SDIO_D2	GDI	I/O	SDIO serial data [2]	Not supported by “00”, “01” and “02” product versions See section 4.2.12 for detailed electrical specs.
45	SDIO_CLK	GDI	O	SDIO serial clock	Not supported by “00”, “01” and “02” product versions See section 4.2.12 for detailed electrical specs.
46	SDIO_CMD	GDI	I/O	SDIO command	Not supported by “00”, “01” and “02” product versions See section 4.2.12 for detailed electrical specs.

No	Name	Power domain	I/O	Description	Remarks
47	SDIO_D0	GDI	I/O	SDIO serial data [0]	Not supported by "00", "01" and "02" product versions See section 4.2.12 for detailed electrical specs.
48	SDIO_D3	GDI	I/O	SDIO serial data [3]	Not supported by "00", "01" and "02" product versions See section 4.2.12 for detailed electrical specs.
49	SDIO_D1	GDI	I/O	SDIO serial data [1]	Not supported by "00", "01" and "02" product versions See section 4.2.12 for detailed electrical specs.
50	GND	-	N/A	Ground	All the GND pins must be connected to ground
51	VCC	-	I	Module supply input	All VCC pins must be connected to external supply. SARA-R404M, SARA-R410M and SARA-N410: supply input for all internal parts. SARA-R412M: supply input for internal BB PMU. See section 4.2.3 and 4.2.4 for detailed specs.
52	VCC	-	I	Module supply input	All VCC pins must be connected to external supply. SARA-R404M, SARA-R410M and SARA-N410: supply input for all internal parts. SARA-R412M: supply input for internal RF PA. See section 4.2.3 and 4.2.4 for detailed specs.
53	VCC	-	I	Module supply input	All VCC pins must be connected to external supply. SARA-R404M, SARA-R410M and SARA-N410: supply input for all internal parts. SARA-R412M: supply input for internal RF PA. See section 4.2.3 and 4.2.4 for detailed specs.
54	GND	-	N/A	Ground	All the GND pins must be connected to ground
55	GND	-	N/A	Ground	All the GND pins must be connected to ground
56	ANT	-	I/O	RF input/output	50 Ω nominal impedance. See section 4.2.5 for detailed electrical specs.
57	GND	-	N/A	Ground	All the GND pins must be connected to ground
58	GND	-	N/A	Ground	All the GND pins must be connected to ground
59	GND	-	N/A	Ground	All the GND pins must be connected to ground
60	GND	-	N/A	Ground	All the GND pins must be connected to ground
61	GND	-	N/A	Ground	All the GND pins must be connected to ground
62	ANT_DET	ADC	I	Antenna detection	Antenna presence detection function. See section 4.2.7 for detailed electrical specs.
63	GND	-	N/A	Ground	All the GND pins must be connected to ground
64	GND	-	N/A	Ground	All the GND pins must be connected to ground
65-96	GND	-	N/A	Ground	All the GND pins must be connected to ground

**Table 5: SARA-R4/N4 series pin-out**

 For more information about the pin-out, see the u-blox SARA-R4/N4 series System Integration Manual [2].

 See Appendix A for an explanation of the abbreviations and terms used.

## 4 Electrical specifications

Stressing the device above one or more of the ratings listed in the Absolute Maximum Rating section may cause permanent damage. These are stress ratings only. Operating the module at these or at any conditions other than those specified in the Operating Conditions sections (section 4.2) of the specification should be avoided. Exposure to Absolute Maximum Rating conditions for extended periods may affect device reliability.

Operating condition ranges define those limits within which the functionality of the device is guaranteed.

Electrical characteristics are defined according to the verification on a representative number of samples or according to the simulation.

Where application information is given, it is advisory only and does not form part of the specification.

### 4.1 Absolute maximum rating

Limiting values given below are in accordance with the Absolute Maximum Rating System (IEC 134).

Symbol	Description	Condition	Min.	Max.	Unit
VCC	Module supply voltage	Input DC voltage at VCC pins (SARA-R404M)	-0.5	6.0	V
		Input DC voltage at VCC pins (SARA-R404M, SARA-R410M and SARA-N410)	-0.5	5.2	V
VUSB_DET	USB detection pin	Input DC voltage at VUSB_DET pin	-0.5	5.5	V
USB	USB D+/D- pins	Input DC voltage at USB interface pins	-0.3	3.6	V
GDI	Generic digital interfaces	Input DC voltage at Generic digital interfaces pins	-0.3	2.3	V
DDC	DDC interface	Input DC voltage at DDC interface pins	-0.3	2.3	V
SIM	SIM interface	Input DC voltage at SIM interface pins	-0.3	3.5	V
ERS	External reset input	Input DC voltage at RESET_N pin	-0.5	2.1	V
POS	Power-on input	Input DC voltage at PWR_ON pin	-0.5	2.1	V
ADC	Antenna detection input	Input DC voltage at ANT_DET pin	-0.5	4.3	V
Rho_ANT	Antenna ruggedness	Output RF load mismatch ruggedness at ANT pins		10:1	VSWR
Tstg	Storage temperature		-40	+85	°C

**Table 6: Absolute maximum ratings**

The product is not protected against overvoltage or reversed voltages. If necessary, voltage spikes exceeding the voltage specifications given in the table above, must be limited to values within the specified boundaries by using appropriate protection devices.



#### 4.1.1 Maximum ESD

Parameter	Min	Typical	Max	Unit	Remarks
ESD sensitivity for all pins			1000	V	Human Body Model according to JESD22-A114

**Table 7: Maximum ESD ratings**

u-blox cellular modules are Electrostatic Sensitive Devices and require special precautions when handling. See section 7.4 for ESD handling instructions.

## 4.2 Operating conditions

-  Unless otherwise indicated, all operating condition specifications are at an ambient temperature of +25 °C.
-  Operation beyond the operating conditions is not recommended and extended exposure beyond them may affect device reliability.

### 4.2.1 Operating temperature range

Parameter	Min.	Typical	Max.	Unit	Remarks
Normal operating temperature	-20	+25	+65	°C	Normal operating temperature range (fully functional and meet 3GPP specifications)
Extended operating temperature	-40		+85	°C	Extended operating temperature range (RF performance may be affected outside normal operating range, though module is fully functional)

Table 8: Environmental conditions

### 4.2.2 Thermal parameters

Symbol	Parameter	Min.	Typical	Max.	Units	Remarks
$\Psi_{M-A}$	Module-to-Ambient thermal parameter		10		°C/W	Thermal characterization parameter $\Psi_{M-A} = (T_M - T_A) / P_H$ proportional to the temperature difference between the internal temperature sensor of the module and the ambient temperature ( $T_A$ ), produced by the module heat power dissipation ( $P_H$ ), with the module mounted on a 79 x 62 x 1.41 mm 4-Layer PCB with a high coverage of copper, in still air conditions
$\Psi_{M-C}$	Module-to-Case thermal parameter		2		°C/W	Thermal characterization parameter $\Psi_{M-C} = (T_M - T_C) / P_H$ proportional to the temperature difference between the internal temperature sensor of the module ( $T_M$ ) and the ambient temperature ( $T_C$ ), produced by the module heat power dissipation ( $P_H$ ), with the module mounted on a 79 x 62 x 1.41 mm 4-Layer PCB with a high coverage of copper, with a robust aluminum heat-sink and with forced air ventilation, i.e. reducing to a value close to 0 °C/W the thermal resistance from the case of the module to the ambient

Table 9: Thermal characterization parameters of the module

### 4.2.3 Supply/power pins

Symbol	Parameter	Module	Min.	Typical	Max.	Unit
VCC	Module supply normal operating input voltage <sup>9</sup>	SARA-R404M	3.2	3.8	4.2	V
		SARA-R410M SARA-N410				
	Module supply extended operating input voltage <sup>10</sup>	SARA-R412M	3.0	3.8	4.5	V
		SARA-R404M SARA-R410M SARA-N410				
	SARA-R412M	3.0	3.8	4.5	V	

**Table 10: Input characteristics of the Supply/Power pins**

Symbol	Parameter	Module	Min.	Typical	Max.	Unit
VSIM	SIM supply output voltage with 1.8 V external SIM	All		1.80		V
	SIM supply output voltage with 3.0 V external SIM			2.95		V
V_INT	Generic Digital Interfaces supply output voltage	All		1.80		V
I_INT	Generic Digital Interfaces supply output current capability	All			70	mA

**Table 11: Output characteristics of the Supply/Power pins**

<sup>9</sup> Input voltage at VCC must be above the normal operating range minimum limit to switch on the module. RF performance may be affected when the input voltage at VCC drops below the herein stated normal operating range minimum limit, though the module is still fully functional.

<sup>10</sup> Ensure that input voltage at VCC never drops below the extended operating range minimum limit during module operation: the cellular module may switch off when the VCC voltage value drops below the herein stated extended operating range minimum limit.<sup>11</sup> Typical values with a matched antenna.

#### 4.2.4 Current consumption

Mode	Condition	Tx power	Min	Typ <sup>11</sup>	Max <sup>12</sup>	Unit
Power Off Mode (module switched off)	Averaged current value			6		μA
PSM Deep Sleep Mode (low power mode)	Averaged current value			8		μA
Active Mode (Power Saving Mode disabled, Module registered with network)	Averaged current value			9		mA
LTE Cat NB1 Connected Mode (Data Tx / Rx)	Averaged current value	Minimum		60		mA
		0 dBm		65		mA
		12 dBm		80		mA
		18 dBm		100		mA
		Maximum		140		mA
	Peak current value during Tx	Maximum				490
LTE Cat M1 Connected Mode (Data Tx / Rx)	Averaged current value	Minimum		100		mA
		0 dBm		105		mA
		12 dBm		125		mA
		18 dBm		150		mA
		Maximum		190		mA
	Peak current value during Tx	Maximum				490
2G Connected Mode (Data Tx / Rx)	Averaged current during a GMSK 1-slot Tx call, 850/900 MHz bands	Maximum		200		mA
	Peak current during a GMSK 1-slot Tx burst, 850/900 MHz bands	Maximum		1.5	1.9	A

**Table 12: Module VCC current consumption**<sup>13</sup>

<sup>11</sup> Typical values with a matched antenna.

<sup>12</sup> Maximum values with a mismatched antenna.<sup>13</sup> All values with VCC = 3.8 V, with UART connected and USB disconnected.

<sup>13</sup> All values with VCC = 3.8 V, with UART connected and USB disconnected.

## 4.2.5 LTE RF characteristics

The LTE bands supported by SARA-R4/N4 series modules are defined in Table 2, while the following Table 13 describes the Transmitting and Receiving frequencies according to 3GPP TS 36.521-1 [7].

Parameter		Min.	Max.	Unit	Remarks
Frequency range FDD Band 12 (700 MHz)	Uplink	699	716	MHz	Module transmit
	Downlink	729	746	MHz	Module receive
Frequency range FDD Band 17 (700 MHz)	Uplink	704	716	MHz	Module transmit
	Downlink	734	746	MHz	Module receive
Frequency range FDD Band 28 (700 MHz)	Uplink	703	748	MHz	Module transmit
	Downlink	758	803	MHz	Module receive
Frequency range FDD Band 13 (700 MHz)	Uplink	777	787	MHz	Module transmit
	Downlink	746	756	MHz	Module receive
Frequency range FDD Band 20 (800 MHz)	Uplink	832	862	MHz	Module transmit
	Downlink	791	821	MHz	Module receive
Frequency range FDD Band 26 (850 MHz)	Uplink	814	849	MHz	Module transmit
	Downlink	859	894	MHz	Module receive
Frequency range FDD Band 18 (850 MHz)	Uplink	815	830	MHz	Module transmit
	Downlink	860	875	MHz	Module receive
Frequency range FDD Band 5 (850 MHz)	Uplink	824	849	MHz	Module transmit
	Downlink	869	894	MHz	Module receive
Frequency range FDD Band 19 (850 MHz)	Uplink	830	845	MHz	Module transmit
	Downlink	875	890	MHz	Module receive
Frequency range FDD Band 8 (900 MHz)	Uplink	880	915	MHz	Module transmit
	Downlink	925	960	MHz	Module receive
Frequency range FDD Band 4 (1700 MHz)	Uplink	1710	1755	MHz	Module transmit
	Downlink	2110	2155	MHz	Module receive
Frequency range FDD Band 3 (1800 MHz)	Uplink	1710	1785	MHz	Module transmit
	Downlink	1805	1880	MHz	Module receive
Frequency range FDD Band 2 (1900 MHz)	Uplink	1850	1910	MHz	Module transmit
	Downlink	1930	1990	MHz	Module receive
Frequency range FDD Band 25 (1900 MHz)	Uplink	1850	1915	MHz	Module transmit
	Downlink	1930	1995	MHz	Module receive
Frequency range TDD Band 39 (1900 MHz) <sup>14</sup>	Uplink	1880	1920	MHz	Module transmit
	Downlink	1880	1920	MHz	Module receive
Frequency range FDD Band 1 (2100 MHz)	Uplink	1920	1980	MHz	Module transmit
	Downlink	2110	2170	MHz	Module receive

**Table 13: LTE operating RF frequency bands**

SARA-R4/N4 series modules include a UE Power Class 3 LTE Cat M1 / NB1 transmitter (see Table 2), with output power and characteristics according to 3GPP TS 36.521-1 [7].

SARA-R4/N4 series modules LTE receiver characteristics are compliant to 3GPP TS 36.521-1 [7], with LTE conducted receiver sensitivity performance described in Table 14 and Table 15.

<sup>14</sup> Supported in LTE category M1 only



Parameter	Min.	Typical	Max.	Unit	Remarks
Receiver input sensitivity Band 12 / 17 (700 MHz)		-107.0		dBm	Without repetitions
Receiver input sensitivity Band 28 (700 MHz)		-105.0		dBm	Without repetitions
Receiver input sensitivity Band 13 (700 MHz)		-105.0		dBm	Without repetitions
Receiver input sensitivity Band 20 (800 MHz)		-105.0		dBm	Without repetitions
Receiver input sensitivity Band 5 / 18 / 19 / 26 (850 MHz)		-105.5		dBm	Without repetitions
Receiver input sensitivity Band 8 (900 MHz)		-106.5		dBm	Without repetitions
Receiver input sensitivity Band 4 (1700 MHz)		-107.5		dBm	Without repetitions
Receiver input sensitivity Band 3 (1800 MHz)		-106.0		dBm	Without repetitions
Receiver input sensitivity Band 2 / 25 (1900 MHz)		-106.0		dBm	Without repetitions
Receiver input sensitivity Band 1 (2100 MHz)		-107.5		dBm	Without repetitions

Condition: 50  $\Omega$  source, throughput > 95%, QPSK modulation, other settings as per 3GPP TS 36.521-1 [7]

**Table 14: LTE Cat M1 receiver sensitivity performance**

Parameter	Min.	Typical	Max.	Unit	Remarks
Receiver input sensitivity Band 12 / 17 (700 MHz)		-113.5		dBm	Without repetitions
Receiver input sensitivity Band 28 (700 MHz)		-112.0		dBm	Without repetitions
Receiver input sensitivity Band 13 (700 MHz)		-112.0		dBm	Without repetitions
Receiver input sensitivity Band 20 (800 MHz)		-112.0		dBm	Without repetitions
Receiver input sensitivity Band 5 / 18 / 19 / 26 (850 MHz)		-112.5		dBm	Without repetitions
Receiver input sensitivity Band 8 (900 MHz)		-113.0		dBm	Without repetitions
Receiver input sensitivity Band 4 (1700 MHz)		-114.0		dBm	Without repetitions
Receiver input sensitivity Band 3 (1800 MHz)		-113.0		dBm	Without repetitions
Receiver input sensitivity Band 2 / 25 (1900 MHz)		-113.0		dBm	Without repetitions
Receiver input sensitivity Band 1 (2100 MHz)		-114.0		dBm	Without repetitions

Condition: 50  $\Omega$  source, throughput > 95%, other settings as per 3GPP TS 36.521-1 [7]

**Table 15: LTE Cat NB1 receiver sensitivity performance**

## 4.2.6 2G RF characteristics

The 2G bands supported by SARA-R4/N4 series modules are defined in [Table 2](#), while the following [Table 16](#) describes the Transmitting and Receiving frequencies according to 3GPP TS 51.010-1 [8].

Parameter		Min	Max	Unit	Remarks
Frequency range GSM 850	Uplink	824	849	MHz	Module transmit
	Downlink	869	894	MHz	Module receive
Frequency range E-GSM 900	Uplink	880	915	MHz	Module transmit
	Downlink	925	960	MHz	Module receive
Frequency range DCS 1800	Uplink	1710	1785	MHz	Module transmit
	Downlink	1805	1880	MHz	Module receive
Frequency range PCS 1900	Uplink	1850	1910	MHz	Module transmit
	Downlink	1930	1990	MHz	Module receive

**Table 16: 2G operating RF frequency bands**

SARA-R4/N4 series modules include a GMSK Power Class 4 transmitter for GSM 850 and E-GSM 900 bands, a GMSK Power Class 1 transmitter for DCS 1800 and PCS 1900 bands, a 8-PSK Power Class E2 transmitter for all 2G bands (see [Table 2](#)), with output power and characteristics according to 3GPP TS 51.010-1 [8].

SARA-R4/N4 series modules 2G receiver characteristics are compliant to 3GPP TS 51.010-1 [8], with conducted receiver sensitivity performance described in [Table 17](#).

Parameter	Min	Typical	Max	Unit	Remarks
Receiver input sensitivity GSM 850	-109			dBm	Downlink RF level @ BER Class II < 2.4 %
Receiver input sensitivity E-GSM 900	-109			dBm	Downlink RF level @ BER Class II < 2.4 %
Receiver input sensitivity DCS 1800	-109			dBm	Downlink RF level @ BER Class II < 2.4 %
Receiver input sensitivity PCS 1900	-109			dBm	Downlink RF level @ BER Class II < 2.4 %

Condition: 50 Ω source

**Table 17: 2G receiver sensitivity performance**

## 4.2.7 ANT\_DET pin characteristics

Pin Name	Parameter	Min.	Typ.	Max.	Unit	Remarks
ANT_DET	Output DC current pulse value		35		μA	
	Output DC current pulse time length		1160		μs	

**Table 18: ANT\_DET pin characteristics**

## 4.2.8 PWR\_ON pin

Parameter	Min.	Typical	Max.	Unit	Remarks
Internal supply for PWR_ON Input Signal		1.8		V	The PWR_ON input is pulled up to an internal voltage rail minus a diode drop: the voltage value present at PWR_ON input pin is normally 0.8 V typical.
Low-level input	-0.30		0.35	V	
Pull-up resistance	150	200	250	kΩ	Internal active pull-up
Input leakage current	-0.20		0.20	μA	
PWR_ON low time	0.15		3.20	s	Low time to switch on the module from power off mode
	0.15		3.20	s	Low time to wake-up the module from PSM deep sleep
	1.50			s	Low time to switch off the module

Table 19: PWR\_ON pin characteristics

## 4.2.9 RESET\_N pin

Parameter	Min.	Typical	Max.	Unit	Remarks
Internal supply for RESET_N Input Signal		1.8		V	
Low-level input	-0.30		0.63	V	
Pull-up resistance		37		kΩ	Internal active pull-up
Input leakage current	-0.20		0.20	μA	
RESET_N low time	10			s	Low time to switch off the module

Table 20: RESET\_N pin characteristics

## 4.2.10 SIM pins

The SIM pins are a dedicated interface to the external SIM card/chip. The electrical characteristics fulfill the regulatory specification requirements. The values in [Table 21](#) are for information only.

Parameter	Min.	Typ.	Max.	Unit	Remarks	
Low-level input	-0.30		0.2*VSIM	V		
High-level input		0.7*VSIM		VSIM+0.3	V	
Low-level output			0	0.4	V	Max value at I <sub>OL</sub> = +2.0 mA
High-level output		0.8*VSIM	VSIM		V	Max value at I <sub>OL</sub> = +2.0 mA
Internal pull-up resistor on SIM_IO			4.7		kΩ	Internal pull-up to VSIM supply
Input leakage current	-2			2	μA	V <sub>IN</sub> = 0 V or V <sub>IN</sub> = VSIM
Clock frequency on SIM_CLK			4.8		MHz	

Table 21: SIM pin characteristics

### 4.2.11 USB pins

USB data lines (**USB\_D+**/**USB\_D-**) are compliant to the USB 2.0 high-speed specification. See the Universal Serial Bus Revision 2.0 specification [10] for detailed electrical characteristics.

Parameter	Min.	Typical	Max.	Unit	Remarks
USB detection voltage on pin VUSB_DET	4.40	5.00	5.25	V	
High-speed squelch detection threshold (input differential signal amplitude)	100		150	mV	
High speed disconnect detection threshold (input differential signal amplitude)	525		625	mV	
High-speed data signaling input common mode voltage range	-50		500	mV	
High-speed idle output level	-10		10	mV	
High-speed data signaling output high level	360		440	mV	
High-speed data signaling output low level	-10		10	mV	
Chirp J level (output differential voltage)	700		1100	mV	
Chirp K level (output differential voltage)	-900		-500	mV	

**Table 22: USB pin characteristics**

### 4.2.12 Generic Digital Interfaces pins

Parameter	Min	Typical	Max	Unit	Remarks
Internal supply for GDI domain		1.80		V	Digital I/O Interfaces supply (V_INT)
Low-level input	-0.30	0.00	0.63	V	
High-level input	1.17	1.80	2.10	V	
Low-level output		0.00	0.45	V	Max value at IOL = +2.0 mA
High-level output	1.35	1.80		V	Min value at IOH = -2.0 mA
Input leakage current	-1		1	μA	V <sub>IN</sub> =0 V or V <sub>IN</sub> =1.8V
Internal pull-up / pull-down resistance	55		390	kΩ	

**Table 23: GDI pin characteristics**

### 4.2.13 DDC (I<sup>2</sup>C) pins

DDC (I<sup>2</sup>C) lines (**SCL** and **SDA**) are compliant to the I<sup>2</sup>C-bus standard mode specification. See the I<sup>2</sup>C-Bus Specification [11] for detailed electrical characteristics.

Parameter	Min	Typical	Max	Unit	Remarks
Internal supply for GDI domain		1.80		V	Digital I/O Interfaces supply (V_INT)
Low-level input	-0.30	0.00	0.63	V	
High-level input	1.17	1.80	2.10	V	
Low-level output		0.00	0.45	V	Max value at I <sub>OL</sub> = +2.0 mA
Internal pull-up resistance		2.2		kΩ	
Input/output leakage current	-1		1	μA	V <sub>IN</sub> =0 V or V <sub>IN</sub> =1.8V
Clock frequency on SCL		100		kHz	

**Table 24: DDC (I<sup>2</sup>C) pin characteristics**

## 5 Mechanical specifications

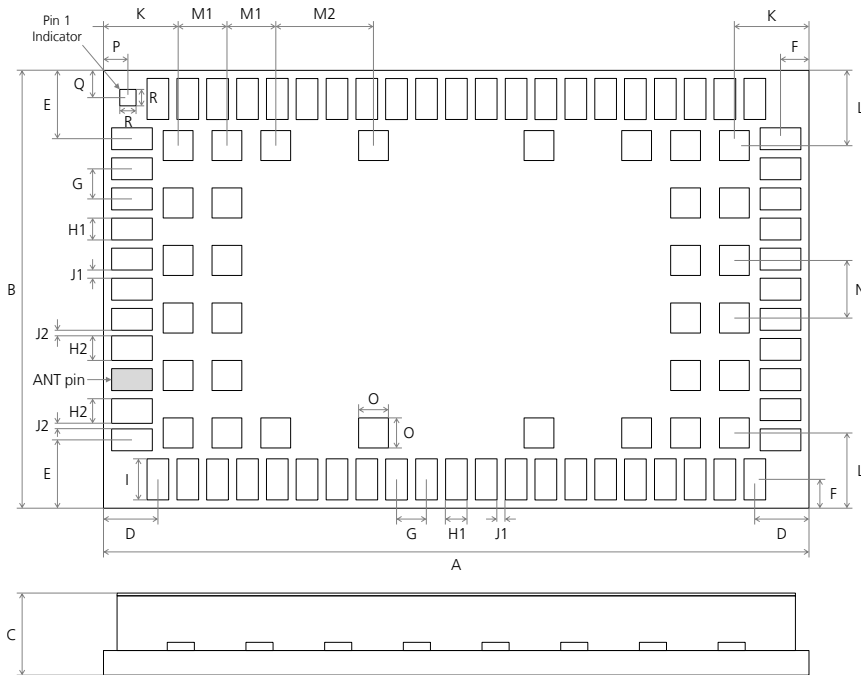

Figure 3: SARA-R4/N4 series dimensions (bottom and side views)

Parameter	Description	Typical	Tolerance
A	Module Height [mm]	26.0 (1023.6 mil)	+0.20/-0.20 (+7.9/-7.9 mil)
B	Module Width [mm]	16.0 (629.9 mil)	+0.20/-0.20 (+7.9/-7.9 mil)
C	Module Thickness [mm]	2.53 (99.5 mil)	+0.25/-0.15 (+9.8/-5.9 mil)
D	Horizontal Edge to Lateral Pin Pitch [mm]	2.0 (78.7 mil)	+0.20/-0.20 (+7.9/-7.9 mil)
E	Vertical Edge to Lateral Pin Pitch [mm]	2.5 (98.4 mil)	+0.20/-0.20 (+7.9/-7.9 mil)
F	Edge to Lateral Pin Pitch [mm]	1.05 (41.3 mil)	+0.20/-0.20 (+7.9/-7.9 mil)
G	Lateral Pin to Pin Pitch [mm]	1.1 (43.3 mil)	+0.02/-0.02 (+0.8/-0.8 mil)
H1	Lateral Pin Height [mm]	0.8 (31.5 mil)	+0.02/-0.02 (+0.8/-0.8 mil)
H2	Lateral Pin close to ANT Height [mm]	0.9 (35.4 mil)	+0.02/-0.02 (+0.8/-0.8 mil)
I	Lateral Pin Width [mm]	1.5 (59.1 mil)	+0.02/-0.02 (+0.8/-0.8 mil)
J1	Lateral Pin to Pin Distance [mm]	0.3 (11.8 mil)	+0.02/-0.02 (+0.8/-0.8 mil)
J2	Lateral Pin to Pin close to ANT Distance [mm]	0.2 (7.9 mil)	+0.02/-0.02 (+0.8/-0.8 mil)
K	Horizontal Edge to Central Pin Pitch [mm]	2.75 (108.3 mil)	+0.20/-0.20 (+7.9/-7.9 mil)
L	Vertical Edge to Central Pin Pitch [mm]	2.75 (108.3 mil)	+0.20/-0.20 (+7.9/-7.9 mil)
M1	Central Pin to Pin Horizontal Pitch [mm]	1.8 (70.9 mil)	+0.02/-0.02 (+0.8/-0.8 mil)
M2	Central Pin to Pin Horizontal Pitch [mm]	3.6 (141.7 mil)	+0.02/-0.02 (+0.8/-0.8 mil)
N	Central Pin to Pin Vertical Pitch [mm]	2.1 (82.7 mil)	+0.02/-0.02 (+0.8/-0.8 mil)
O	Central Pin Height and Width [mm]	1.1 (43.3 mil)	+0.02/-0.02 (+0.8/-0.8 mil)
P	Horizontal Edge to Pin 1 Indicator Pitch [mm]	0.9 (35.4 mil)	+0.20/-0.20 (+7.9/-7.9 mil)
Q	Vertical Edge to Pin 1 Indicator Pitch [mm]	1.0 (39.4 mil)	+0.20/-0.20 (+7.9/-7.9 mil)
R	Pin 1 Indicator Height and Width [mm]	0.6 (23.6 mil)	+0.02/-0.02 (+0.8/-0.8 mil)
Weight	Module Weight [g]	< 3	

Table 25: SARA-R4/N4 series dimensions

- The module height tolerance  $\pm 0.20$  mm may be exceeded close to the corners of the PCB due to the cutting process: in the worst cases, the height could be  $+0.40$  mm longer than the typical value.
- For information regarding Footprint and Paste Mask recommended for the application board integrating the cellular module, see the SARA-R4/N4 series System Integration Manual [2].

## 6 Qualification and approvals

### 6.1 Reliability tests

Tests for product family qualifications according to ISO 16750 “Road v-ehicles - Environmental conditions and testing for electrical and electronic equipment“, and appropriate standards.

#### 6.1.1 Approvals



Products marked with this lead-free symbol on the product label comply w“th the "Directive 2002/95/EC of the European Parliament and the Council on the Restriction of Use of certain Hazardous Substances in Electrical and Electronic E”uipment" (RoHS).

SARA-R4/N4 series modules are RoHS compliant.

No natural rubbers, hygroscopic materials, or materials containing asbestos are employed.

[Table 27](#) summarizes the main approvals for SARA-R4/N4 series modules.

Certification	SARA-R404M-00B	SARA-R410M-01B	SARA-R410M-02B	SARA-R412M-02B	SARA-N410-02B
GCF			•		
PTCRB		•	•	•	•
CE Europe			•	•	
FCC US	•	•	•	•	•
FCC ID	XPY2AGQN1NNN	XPY2AGQN4NNN	XPY2AGQN4NNN		
ISED Canada		•	•	•	•
ISED ID		8595A-2AGQN4NNN	8595A-2AGQN4NNN		
IFT Mexico		•	•		
RCM Australia			•		
NCC Taiwan			•		
Verizon	•		•		
AT&T		•	•	•	
T-Mobile			•		•
Bell		•			
Telus		•			
Telstra			•		

**Table 26: SARA-R4/N4 series main certification approvals summary**



For guidelines and notices about compliance with certification approvals requirements integrating the SARA-R4/N4 series modules in the end-device, see the SARA-R4/N4 series System Integration Manual [2].



For the complete list of approvals and for specific details on all country, conformance and network operators’ certifications, including related certificates of compliancy, please contact the u-blox office or sales representative nearest you.

# 7 Product handling & soldering

## 7.1 Packaging

SARA-R4/N4 series modules are delivered as hermetically sealed, reeled tapes to enable efficient production, production lot set-up and tear-down. For more information about packaging, see the u-blox Package Information User Guide [3].

### 7.1.1 Reels

SARA-R4/N4 series modules are deliverable in quantities of 250 pieces on a reel. The modules are delivered using reel type B2 described in Figure 4 and in the u-blox Package Information Guide [3].

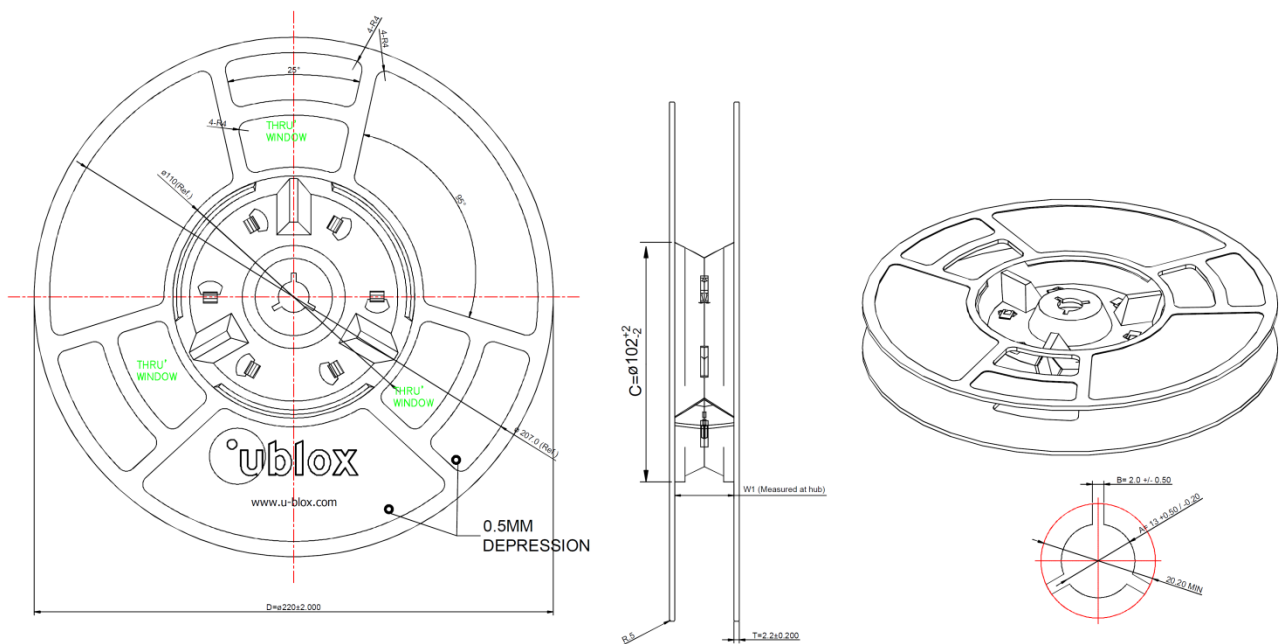

NOTE: ALL DIMENSIONS IN MILLIMETERS

Figure 4: SARA-R4/N4 series modules reel

Parameter	Specification
Reel Type	B2
Delivery Quantity	250

Table 27: Reel information for SARA-R4/N4 series modules

Quantities of less than 250 pieces are also available. Contact u-blox for more information.

## 7.1.2 Tapes

Figure 5 and Table 28 specify the dimensions of the tape used for the delivery of SARA-R4/N4 series modules.

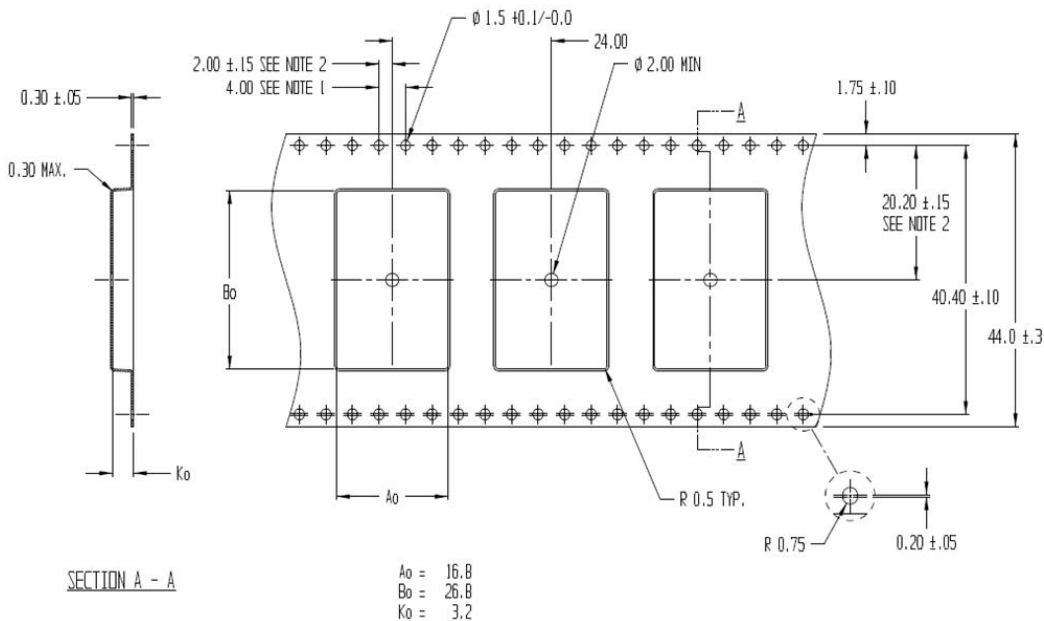

Figure 5: SARA-R4/N4 series modules tape

Parameter	Typical value	Tolerance	Unit
$A_0$	16.8	0.2	mm
$B_0$	26.8	0.2	mm
$K_0$	3.2	0.2	mm

Table 28: SARA-R4/N4 series tape dimensions (mm)

- Note 1: 10 sprocket hole pitch cumulative tolerance  $\pm 0.2$  mm.
- Note 2: pocket position relative to sprocket hole is measured as true position of pocket, not pocket hole.
- Note 3:  $A_0$  and  $B_0$  are calculated on a plane at a distance “R” above the bottom of the pocket.



## 7.2 Moisture Sensitivity Levels

-  SARA-R4/N4 series modules are Moisture Sensitive Devices (MSD) in accordance to the IPC/JEDEC specification.

The Moisture Sensitivity Level (MSL) relates to the packaging and handling precautions required. SARA-R4/N4 series modules are rated at MSL level 4. For more information regarding moisture sensitivity levels, labeling, storage and drying, see the u-blox Package Information Guide [3].

-  For the MSL standard, see IPC/JEDEC J-STD-020 (can be downloaded from [www.jedec.org](http://www.jedec.org)).

## 7.3 Reflow soldering

Reflow profiles are to be selected according to u-blox recommendations (see the SARA-R4/N4 series System Integration Manual [2]).

-  Failure to observe these recommendations can result in severe damage to the device!

## 7.4 ESD precautions

-  SARA-R4/N4 series modules contain highly sensitive electronic circuitry and are Electrostatic Sensitive Devices (ESD). Handling SARA-R4/N4 series modules without proper ESD protection may destroy or damage them permanently.

SARA-R4/N4 series modules are Electrostatic Sensitive Devices (ESD) and require special ESD precautions typically applied to ESD sensitive components.

[Table 7](#) details the maximum ESD ratings of the SARA-R4/N4 series modules.

Proper ESD handling and packaging procedures must be applied throughout the processing, handling and operation of any application that incorporates the SARA-R4/N4 series module.

ESD precautions should be implemented on the application board where the module is mounted, as described in the SARA-R4/N4 series System Integration Manual [2].

-  Failure to observe these recommendations can result in severe damage to the device!

## 8 Labeling and ordering information

### 8.1 Product labeling

The labels of SARA-R4/N4 series modules include important product information as described in this section. [Figure 6](#) illustrates the label of all the SARA-R4/N4 series modules, and includes: u-blox logo, production lot, Pb-free marking, product type number, IMEI number, certification information, and production country.

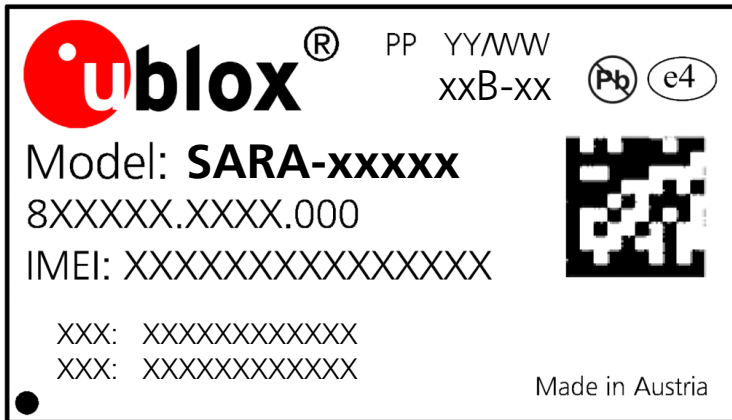

Figure 6: SARA-R4/N4 series module label

### 8.2 Explanation of codes

Three different product code formats are used. The **Product Name** is used in documentation such as this data sheet and identifies all the u-blox products, independent of packaging and quality grade. The **Ordering Code** includes options and quality, while the **Type Number** includes the hardware and firmware versions. [Table 29](#) details these 3 different formats:

Format	Structure
Product Name	PPPP-TGVV(L)
Ordering Code	PPPP-TGVV(L)-MMQ
Type Number	PPPP-TGVV(L)-MMQ-XX

Table 29: Product code formats

[Table 30](#) explains the parts of the product code.

Code	Meaning	Example
PPPP	Form factor	SARA
TG	Platform (Technology and Generation) Dominant technology: G: GSM; U: HSUPA; C: CDMA 1xRTT; N: NB-IoT (LTE Cat NB1); R: LTE low data rate (Cat 1 and Cat M1); L: LTE high data rate (Cat 3 and above) Generation: 1...9	R4
VV	Variant function set based on the same platform: 00...99	04
(L)	LTE category: 6,4,3,1,M ...	M
MM	Major product version: 00...99	00
Q	Product grade: B = professional, A = automotive	B
XX	Minor product version (not relevant for certification)	Default value is 00

Table 30: Part identification code

### 8.3 Ordering information

Ordering No.	Product
SARA-R404M-00B	LTE Cat M1 module Designed for operation in LTE band 13 26.0 x 16.0 mm, 250 pieces/reel
SARA-R410M-01B	LTE Cat M1 module Designed for operation in LTE bands 2, 4, 5, 12 26.0 x 16.0 mm, 250 pieces/reel
SARA-R410M-02B	LTE Cat M1 / NB1 module Designed for operation in LTE bands 2, 3, 4, 5, 8, 12, 13, 20, 28 26.0 x 16.0 mm, 250 pieces/reel
SARA-R412M-02B	LTE Cat M1 / NB1 and 2G module Designed for operation in LTE bands 2, 3, 4, 5, 8, 12, 13, 20 and 2G bands 850, 900, 1800, 1900 26.0 x 16.0 mm, 250 pieces/reel
SARA-N410-02B	LTE Cat NB1 module Designed for operation in LTE bands 2, 4, 5, 12, 13 26.0 x 16.0 mm, 250 pieces/reel

**Table 31: Product ordering codes**

# Appendix

## A Glossary

Abbreviation	Definition
2G	2nd Generation Cellular Technology (GSM, GPRS, EGPRS)
3G	3rd Generation Cellular Technology (UMTS, HSDPA, HSUPA)
3GPP	3rd Generation Partnership Project
8PSK	8-Phase Shift Keying modulation
ADC	Analog to Digital Converter
AT	AT Command Interpreter Software Subsystem, or attention
BB	Baseband
BER	Bit Error Rate
Cat	Category
CBS	Cell Broadcast Service
CCC	China Compulsory Certificate
CDMA	Code-Division Multiple Access
CE	European Conformity
CLK	Clock
CMOS	Complementary Metal-Oxide-Semiconductor
CS	Chip Select
CTS	Clear To Send
DC	Direct Current
DCD	Data Carrier Detect
DCS	Digital Cellular System
DDC	Display Data Channel
DL	Down Link (Reception)
DRX	Discontinuous Reception
DSR	Data Set Ready
DTE	Data Terminal Equipment
DTR	Data Terminal Ready
DUN	Dial-Up Networking
EDGE	Enhanced Data rates for GSM Evolution (EGPRS)
EDRX	Extended Discontinuous Reception
EGPRS	Enhanced General Packet Radio Service (EDGE)
ERS	External Reset Signal
ESD	Electrostatic Discharge
E-UTRA	Evolved Universal Terrestrial Radio Access
FCC	Federal Communications Commission United States
FDD	Frequency Division Duplex
FOAT	Firmware (update) Over AT commands
FOTA	Firmware (update) Over-The-Air
FTP	File Transfer Protocol
FW	Firmware
GCF	Global Certification Forum
GDI	Generic Digital Interface

Abbreviation	Definition
GMSK	Gaussian Minimum-Shift Keying modulation
GND	Ground
GNSS	Global Navigation Satellite System
GPIO	General Purpose Input/Output
GPRS	General Packet Radio Services
GSM	Global System for Mobile communications
HDLC	High-level Data Link Control
HSDPA	High Speed Downlink Packet Access
HSUPA	High Speed Uplink Packet Access
HTTP	HyperText Transfer Protocol
HW	Hardware
IEC	International Electrotechnical Commission
IFT	Federal Telecommunications Institute Mexico
I <sup>2</sup> C	Inter-Integrated Circuit
I <sup>2</sup> S	Inter-IC Sound
I/O	Input/Output
IMEI	International Mobile Equipment Identity
IP	Internet Protocol
ISED	Innovation, Science and Economic Development Canada
ISO	International Organization for Standardization
ITU	International Telecommunications Union
LGA	Land Grid Array
LPWA	Low Power Wide Area
LTE	Long-Term Evolution
LWM2M	Open Mobile Alliance Lightweight Machine-to-Machine protocol
M2M	Machine to Machine
MISO	Multiple Input Single Output
MOSI	Master Output Slave Input
MQTT	Message Queuing Telemetry Transport
MSD	Moisture Sensitive Device
MSL	Moisture Sensitivity Level
MUX	Multiplexer
N/A	Not Applicable
NCC	National Communications Commission Taiwan
PA	Power Amplifier
PCB	Printed Circuit Board
PCN	Product Change Notification / Sample Delivery Note / Information Note
PMU	Power Management Unit
POS	Power On Signal
PPS	Protocol and Parameter Selection
PSM	Power Saving Mode
PTCRB	PCS Type Certification Review Board
QPSK	Quadrature Phase Shift Keying modulation
RAM	Random Access Memory
RAT	Radio Access Technology
RF	Radio Frequency

Abbreviation	Definition
RI	Ring Indicator
RIL	Radio Interface Layer
RTS	Request To Send
SCL	Serial Clock
SDA	Serial Data
SDIO	Secure Digital Input Output
SIM	Subscriber Identity Module
SMS	Short Message Service
SPI	Serial Peripheral Interface
SRRC	State Radio Regulation Committee China
SSL	Secure Socket Layer
TA	Timing Advance
TCP	Transmission Control Protocol
TDD	Time Division Duplex
TLS	Transport Layer Security
TS	Technical Specification
TXD	Transmit Data
UART	Universal Asynchronous Receiver/Transmitter
UBX	u-blox proprietary messaging protocol
UDP	User Datagram Protocol
UE	User Equipment
UL	Uplink (Transmission)
UMTS	Universal Mobile Telecommunications System
USB	Universal Serial Bus
VoLTE	Voice over LTE
VSWR	Voltage Standing Wave Ratio
WA	Word Alignment

**Table 32: Explanation of the abbreviations and terms used**

## Related documents

- [1] u-blox SARA-R4/N4 series AT Commands Manual, Doc. No. UBX-17003787
- [2] u-blox SARA-R4/N4 series System Integration Manual, Doc. No. UBX-16029218
- [3] u-blox Package Information User Guide, Doc. No. UBX-14001652
- [4] 3GPP TS 27.007 - AT command set for User Equipment (UE)
- [5] 3GPP TS 27.005 - Use of Data Terminal Equipment - Data Circuit terminating Equipment (DTE - DCE) interface for Short Message Service (SMS) and Cell Broadcast Service (CBS)
- [6] 3GPP TS 27.010 - Terminal Equipment to User Equipment (TE-UE) multiplexer protocol
- [7] 3GPP TS 36.521-1 - Evolved Universal Terrestrial Radio Access; User Equipment conformance specification; Radio transmission and reception; Part 1: Conformance Testing
- [8] 3GPP TS 51.010-1 - Mobile Station conformance specification; Part 1: Conformance specification
- [9] ITU-T Recommendation V24, 02-2000. List of definitions for interchange circuits between Data Terminal Equipment (DTE) and Data Connection Equipment (DCE)
- [10] Universal Serial Bus Revision 2.0 specification, [www.usb.org/developers/docs/usb20\\_docs/](http://www.usb.org/developers/docs/usb20_docs/)
- [11] I2C-bus specification and user manual - Rev.5- 9 October 2012 - NXP Semiconductors, [www.nxp.com/documents/user\\_manual/UM10204.pdf](http://www.nxp.com/documents/user_manual/UM10204.pdf)

 For regular updates to u-blox documentation and to receive product change notifications, register on our homepage ([www.u-blox.com](http://www.u-blox.com)).

## Revision history

Revision	Date	Name	Comments
R01	07-Oct-2016	sfal	Initial release
R02	02-Feb-2017	sfal	Updated supported features and electrical characteristics
R03	05-May-2017	sfal / sses	Updated supported features and electrical characteristics Added the SARA-R410M-01B product version
R04	24-May-2017	sses	Updated supported features and electrical characteristics
R05	19-Jul-2017	sses	Updated supported features and electrical characteristics Extended document applicability to SARA-R410M-02B product version
R06	17-Aug-2017	sses	Updated supported features for "02" product version
R07	30-Oct-2017	sses	Updated SARA-R410M-01B product status Updated supported features for "02" product version
R08	04-Jan-2018	sses	Updated SARA-R410M-02B product status Updated USB, GPIO and other features description
R09	26-Feb-2018	sses	Updated SARA-R410M-02B product status Extended document applicability to SARA-R412M-02B product version Added Current consumption, Rx sensitivity and Thermal figures Updated UART MUX and Approvals info
R10	07-Mar-2018	mbab	u-blox rebranding. Updated SARA-R412M-02B modem and app version
R11	09-May-2018	sses	Updated SARA-R410M-02B product status Extended document applicability to SARA-N410-02B product version Updated UART and Approvals info



# Contact

For complete contact information, visit us at [www.u-blox.com](http://www.u-blox.com).

## u-blox Offices

### North, Central and South America

#### u-blox America, Inc.

Phone: +1 703 483 3180  
E-mail: [info\\_us@u-blox.com](mailto:info_us@u-blox.com)

#### Regional Office West Coast:

Phone: +1 408 573 3640  
E-mail: [info\\_us@u-blox.com](mailto:info_us@u-blox.com)

#### Technical Support:

Phone: +1 703 483 3185  
E-mail: [support@u-blox.com](mailto:support@u-blox.com)

### Headquarters

#### Europe, Middle East, Africa

#### u-blox AG

Phone: +41 44 722 74 44  
E-mail: [info@u-blox.com](mailto:info@u-blox.com)  
Support: [support@u-blox.com](mailto:support@u-blox.com)

### Asia, Australia, Pacific

#### u-blox Singapore Pte. Ltd.

Phone: +65 6734 3811  
E-mail: [info\\_ap@u-blox.com](mailto:info_ap@u-blox.com)  
Support: [support\\_ap@u-blox.com](mailto:support_ap@u-blox.com)

#### Regional Office Australia:

Phone: +61 2 8448 2016  
E-mail: [info\\_au@u-blox.com](mailto:info_au@u-blox.com)  
Support: [support\\_ap@u-blox.com](mailto:support_ap@u-blox.com)

#### Regional Office China (Beijing):

Phone: +86 10 68 133 545  
E-mail: [info\\_cn@u-blox.com](mailto:info_cn@u-blox.com)  
Support: [support\\_cn@u-blox.com](mailto:support_cn@u-blox.com)

#### Regional Office China (Chongqing):

Phone: +86 23 6815 1588  
E-mail: [info\\_cn@u-blox.com](mailto:info_cn@u-blox.com)  
Support: [support\\_cn@u-blox.com](mailto:support_cn@u-blox.com)

#### Regional Office China (Shanghai):

Phone: +86 21 6090 4832  
E-mail: [info\\_cn@u-blox.com](mailto:info_cn@u-blox.com)  
Support: [support\\_cn@u-blox.com](mailto:support_cn@u-blox.com)

#### Regional Office China (Shenzhen):

Phone: +86 755 8627 1083  
E-mail: [info\\_cn@u-blox.com](mailto:info_cn@u-blox.com)  
Support: [support\\_cn@u-blox.com](mailto:support_cn@u-blox.com)

#### Regional Office India:

Phone: +91 80 405 092 00  
E-mail: [info\\_in@u-blox.com](mailto:info_in@u-blox.com)  
Support: [support\\_in@u-blox.com](mailto:support_in@u-blox.com)

#### Regional Office Japan (Osaka):

Phone: +81 6 6941 3660  
E-mail: [info\\_jp@u-blox.com](mailto:info_jp@u-blox.com)  
Support: [support\\_jp@u-blox.com](mailto:support_jp@u-blox.com)

#### Regional Office Japan (Tokyo):

Phone: +81 3 5775 3850  
E-mail: [info\\_jp@u-blox.com](mailto:info_jp@u-blox.com)  
Support: [support\\_jp@u-blox.com](mailto:support_jp@u-blox.com)

#### Regional Office Korea:

Phone: +82 2 542 0861  
E-mail: [info\\_kr@u-blox.com](mailto:info_kr@u-blox.com)  
Support: [support\\_kr@u-blox.com](mailto:support_kr@u-blox.com)

#### Regional Office Taiwan:

Phone: +886 2 2657 1090  
E-mail: [info\\_tw@u-blox.com](mailto:info_tw@u-blox.com)  
Support: [support\\_tw@u-blox.com](mailto:support_tw@u-blox.com)