



zBoost ZB645SL User Manual



zBoost® products have a 30-day money back guarantee when purchased directly from zBoost. If product is purchased from a reseller or third party, the purchaser is subject to the policies of the third party.

1 Year manufacturer warranty. Warranty registration at www.zBoost.com

FCC Requirements

This is a CONSUMER Device.

BEFORE USE, you MUST REGISTER THIS DEVICE with your wireless provider and have your provider's consent. Most wireless providers consent to the use of signal boosters. AT&T, Sprint, T-Mobile, Verizon and 90 additional carriers have already given consent for all consumers to use this device. Some providers may not consent to the use of this device on their network. If you are unsure, contact your provider.

You MUST operate this device with approved antennas and cables as specified by the manufacturer. Antennas MUST be installed at least 20 cm (8 inches) from any person.

You MUST cease operating this device immediately if requested by the FCC or a licensed wireless service provider.

WARNING. E911 location information may not be provided or may be inaccurate for calls served by using this device.

FCC contact information: www.fcc.gov/signal-boosters/registration.



Warning

Any product modifications that use unauthorized antennas, cables, and/or coupling devices is no longer FCC compliant and will void the product warranty.

About zBoost®

zBoost, a leader in cell phone signal boosters manufactures zBoost, the award-winning line of cell phone signal boosters that enhance the performance of your cell phone, smartphone and wireless data card.

Compatibility – Dual Band zBoosts are compatible with 800 MHz and 1900 MHz regardless of technology- including CDMA and GSM.

Uses patented technologies and protects the carrier network.

1-year manufacturer warranty – Warranty registration at www.zBoost.com.

FCC Information

FCC ID: SO4ZB570-PCS-CEL

Warning: Changes or modifications to this device not expressly approved by zBoost could void the user's authority to operate the equipment.

Note: This equipment has been tested and found to comply with the limits for a Class B digital device, pursuant to Part 15 of the FCC Rules. These limits are designed to provide reasonable protection against harmful interference in a residential installation. This equipment generates, uses, and can radiate radio frequency energy and, if not installed and used in accordance with the instructions, may cause harmful interference to radio communications. However, there is no guarantee that interference will not occur in a particular installation. If the equipment does cause harmful interference to radio or television reception, which can be determined by turning the equipment off and on, the user is encouraged to try to correct the interference by one or more of the following measures:

- Reorient or relocate the receiving antenna
- Increase the separation between the equipment and receiver
- Connect the equipment to an outlet on a circuit different from that to which the receiver is connected
- Consult the dealer or an experienced radio/TV technician for help

This equipment complies with FCC radiation exposure limits set forth for an uncontrolled environment. This transmitter must not be co-located or operating in conjunction with any other antenna or transmitter. In accordance with FCC requirements of human exposure to radiofrequency fields, the radiating element (antenna) shall be installed such that a minimum separation distance of 20cm (8in) is maintained from all persons.

Industry Canada Regulations

IC ID: 5544A-ZB570PCSEL

This Class B digital apparatus meets all requirements of the Canadian Interference Causing Equipment Regulations. Operation is subject to the following two conditions: (1) this device may not cause harmful interference, and (2) this device must accept any interference received, including interference that may cause undesired operation.

The term "IC:" before the radio certification number only signifies that Industry Canada technical specifications were met.

RF Exposure: The manufacturer's rated output power of this equipment is for single carrier operation. For situations when multiple carrier signals are present, the rating would have to be reduced by 3.5 dB, especially where the output is re-radiated and can cause interference to adjacent band users. This power reduction is to be by means of input power or gain reduction and

not by an attenuator at the output of the device.

Cet appareillage numérique de la classe [B] répond à toutes les exigences de l'interférence canadienne causant des règlements d'équipement. L'opération est sujette aux deux conditions suivantes: (1) ce dispositif peut ne pas causer l'interférence nocive, et (2) ce dispositif doit accepter n'importe quelle interférence reçue, y compris l'interférence qui peut causer l'opération peu désirée.

Le fabricant nominale de la puissance de sortie de ce matériel est simple transporteur. Pour les situations lorsque plusieurs signaux porteurs sont présents, l'évaluation devrait être réduite de 3.5 dB, en particulier lorsque le signal de sortie est ré-émise et peut provoquer des interférences adjacentes à la bande utilisateurs. Ce pouvoir est de la réduction par le biais de la sortie d'alimentation ou la réduction de gain et non par un atténuateur à la sortie du dispositif. Please note: This unit has been approved for use in Canada under RSS 131, however, consent for the use of this device to improve cellular or PCS coverage, must be obtained through your cellular or PCS provider, prior to placing the unit in operation. Please refer to the Industry Canada document CPC 2-1-05, Section 6.1 available or viewable at: <http://www.ic.gc.ca/epic/site/smt-gst.nsf/en/sf08942e.html>

Safety and Product Warranty Information

Copyright Notice

This manual is copyrighted. All rights reserved. This manual, whole or in part, may not be copied, photocopied, reproduced, translated or reduced to any electronic medium or machine readable form for distribution. This manual whole or in part, may not be modified without prior consent, in writing, from zBoost. Copyright © 2014 by zBoost.

Trademarks

zBoost, the zBoost logo, Wireless Extenders, Wi-Ex, the Wi-Ex logo, and Extending Cell Zones are registered trademarks of zBoost.

Safety Guidelines

In accordance with FCC requirements of human exposure to radiofrequency fields, the radiating element (antenna) shall be positioned such that a minimum separation distance of 8 inches (20cm) is maintained between the radiating element and the user and/or general population.

Limited Liability

In no event shall zBoost be liable for any direct, indirect, special, punitive, incidental, exemplary or consequential damages, or any damages, whether in an action under contract, negligence, or any other theory, arising out of or in connection with the set up of, use of, inability to use, or performance of the information, services, products, and materials available from this manual. These limitations shall apply notwithstanding any failure of essential purpose of any limited remedy. Because some jurisdictions do not allow limitations on how long an implied warranty last, or the exclusion or limitation of liability for consequential or incidental damages, the above limitations may not apply to you. For full warranty guidelines, see page 15.



Note

Changes or modifications not expressly approved by zBoost could void the user's authority to operate this equipment and/or void the product warranty.

Package Contents

Before you begin, make sure all of the following parts came with your zBoost ZB645SL.

Item	Description
①	Setup Overview
②	zBoost Base Unit
③	Base Unit Power Supply
④	RG-6 coax, 15 ft. (x2)
⑤	RG-6 coax, 50 ft.
⑥	Indoor Antenna with TNC-F Adaptor
⑦	Outdoor External Antenna with mounting hardware
⑧	Window Entry Cable
⑨	Hardware Kit (anchors, feet, screws)

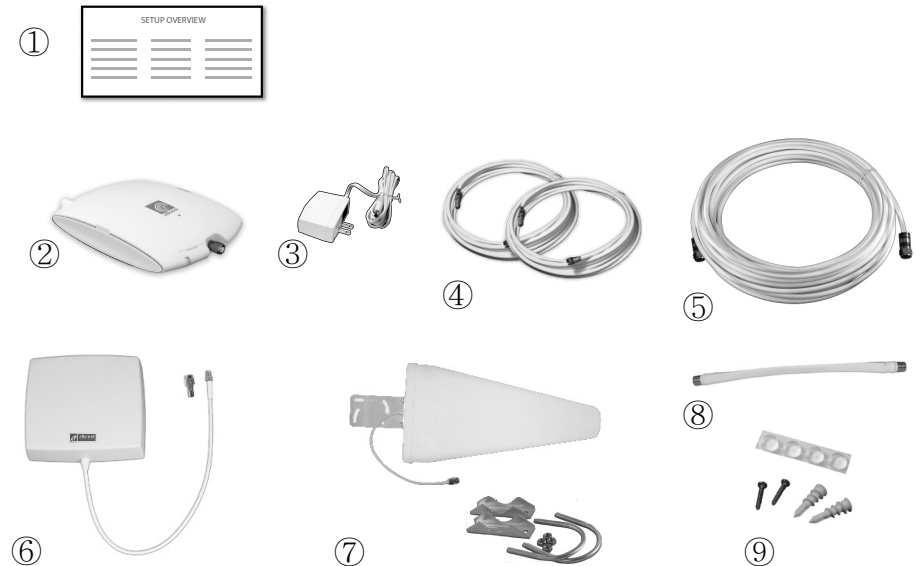

Optional zBoost Accessories

The following accessories are authorized for this zBoost product. Please see our website for complete selection. **To order, call 1-800-871-1612 or visit, www.zBoost.com**

Broadcast Antennas - Indoor	
CANT-0032	Indoor Broadcast Antenna, Omni Whip Direct to Booster, Black, CEL-PCS (1 dBi)
CANT-0034	Indoor Broadcast Antenna, Omni Whip Direct to Booster, White, CEL-PCS (1 dBi)
CANT-0039	Indoor Broadcast Antenna, Omni Whip Direct to Booster, Black, Wide- Band, LTE-CEL-AWS-PCS (1 dBi)
YX027-F*	Indoor Broadcast Antenna, Directional Panel w/ F-Female Connector, CEL-PCS (6 / 8 dBi)
YX052	Indoor Broadcast Antenna, Wide-Band Ceiling-Mount Omni w/ F-Female Connector, LTE-CEL-AWS-PCS (1 / 2 dBi)
External Antennas - Outdoor	
CANT-0028	Outdoor External Antenna, Directional Low Profile Panel, CEL-AWS-PCS (6 / 8 dBi)
CANT-0031	Window-mount External Antenna for YX540 zBoost METRO Workspace, Directional Panel, CEL-PCS (6 / 8 dBi)
CANT-0033	Outdoor External Antenna, Small Omni, CEL-PCS (3 / 5 dBi)
CANT-0036	Outdoor External Antenna, Omni with Industrial Casing, CEL-PCS (3 / 5 dBi)
CANT-0040	Outdoor External Antenna, Wide-Band Omni Directional, LTE-CEL-AWS-PCS (3 / 5 dBi)
CANT-0042	Outdoor External Antenna, Wide-Band Directional Log Periodic, LTE-CEL-AWS-PCS (10 / 12 dBi)
YX021-CEL	Outdoor External Antenna, Directional Panel, CEL (8 dBi)
YX023-PCS	Outdoor External Antenna, Directional Panel, PCS (13 dBi)
YX026-CEL	Outdoor External Antenna, Directional 3 foot Yagi with 12 Elements, CEL (11 dBi)
YX039-PCS-CEL	Outdoor External Antenna Kit, Two Directional Panels with Combiner, CEL-PCS (8 / 13 dBi)
Coax Cable - To be used in addition to the cable included in your kit	
YX030-0W8	8 Inch Window Entry Cable with F-Female Connectors
YX030-15W	15 Foot RG-6 Coaxial Extension Cable with F-Male Connectors
YX030-35W	35 Foot RG-6 Coaxial Extension Cable with F-Male Connectors
YX030-50W	50 Foot RG-6 Coaxial Cable with F-Male Connectors
YX031-10W	10 Foot RG-8X Coaxial Cable with TNC-Male & Female Connectors (Booster to Distribution Antenna)
YX031-100W	100 Foot Low Loss RG-11 Coaxial Cable with F-Male Connectors
Accessories	
YX012	Outdoor External Antenna Grounding Kit

* The FCC requires that this panel antenna has a minimum horizontal separation of 6 feet (2 meters) from other CMRS (commercial mobile radio service) devices.

Table of Contents

FCC Requirements..... i

FCC Information ii

Industry Canada Regulations ii

Copyright Notice iii

Trademarks iii

Safety Guidelines iii

Limited Liability iii

Safety and Product Warranty Information iii

Package Contents iv

Optional zBoost Accessories v

Table of Contents 1

Overview..... 2

 Why Indoor Signals Can Be Weak 2

Preparing to Set Up Your zBoost Product 3

 Tools Needed 3

 Check for Signal Strength 3

 Cable Requirements..... 4

 Grounding the Directional External Antennas 4

 Securing Cable with a Drip Loop..... 4

 Power Requirements..... 5

 Important Reminders:..... 5

Installing Your zBoost Signal Booster 5

 FIRST: Placement of the External Antenna 5

 Mounting of Antenna 5

 SECOND: Position Base and Indoor Antenna..... 6

 Wall Mounting the Base Unit 6

 THIRD: Run the Coaxial Cable 6

 FOURTH: Connect zBoost Base Unit to Power 7

 Antenna Aiming 7

 Confirm That Your zBoost is Working Properly 10

 Improving Your Coverage Area 10

Base Unit Light Indicators 11

Technical Specifications..... 12

Frequently Asked Questions 13

Warranty Information 15

Overview

Thank you for choosing zBoost! You will now be able to use your cell phone **INSIDE** your home. Gone are the days when you had to go to the window upstairs or walk outside to use your cell phone. Like a skylight that brings sunlight into your home, zBoost transports and amplifies the outdoor signal into your home.

By following the easy instructions in this User Manual, you will be Extending Cell Zones™ into your home.

Why Indoor Signals Can Be Weak

There are several obstacles that can contribute to the poor reception you receive in your home:

1. Location of the Cell Phone Tower in Relation to Your Home

While cell phone providers have tried to place cell phone towers to provide the best overall coverage, local ordinances and terrain features can impose restrictions on where these towers can be placed, thus, limiting the signal strength available at your location.

2. Obstructions Caused by Buildings, Terrain and Trees

Cell phone signals can be completely blocked or reflected by buildings, walls, trees, hills and other terrain features resulting in low signal strength.

3. Energy Efficient Windows

Energy efficient windows contain a metal film that can affect signal penetration into the house.

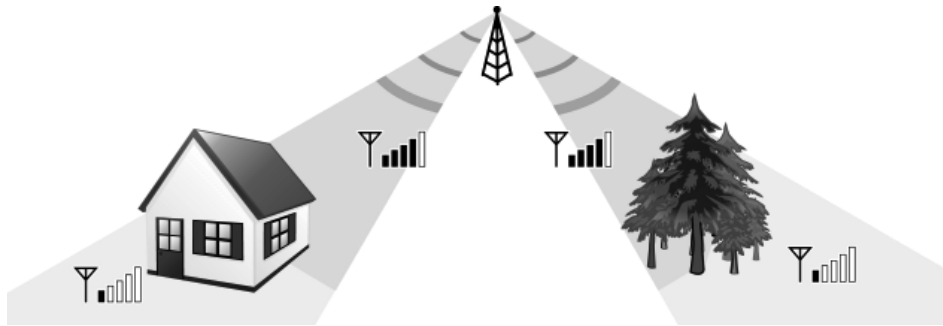

Preparing to Set Up Your zBoost Product

Tools Needed

The following tools are needed to set up zBoost:

- #2 Phillips screwdriver
- Cellular phone operating in the band supported by your zBoost unit
- Drill (may be required for outdoor or attic antenna placement)

Check for Signal Strength

Before placing a zBoost in your home, make sure that you can place calls on the outside of your home, in the attic, at roof level or wherever you plan to place the External Antenna. zBoost can only bring signal into your home when signal reaches the External Antenna. If there is no signal, the zBoost will not work for you.

Using your cell phone, place a call from an outdoor location to confirm that enough signal is present to complete the call. If a weak signal is available at ground level, check the signal strength in your attic or at roof level location where the signal will likely be stronger and where the External Antenna can be placed for best performance.

If you can reliably make and receive calls outside your home, then zBoost can bring the signal into your home.

If only one signal bar is displayed on your cell phone outside, indoor coverage will be limited to one small room. We recommend placing the External Antenna outside and/or purchasing a zBoost upgrade External Antenna for increased coverage (see page v).



Note



Cell phone signal bars are approximate and vary from phone to phone. The number of bars can fluctuate widely, depending on the location of the phone, the position or angle of the phone, weather, etc. Most cell phone signal meters update every 6 to 10 seconds. An increase of only one bar typically indicates a 4x to 10x signal increase.

Before installing, please note the following important factors in determining your zBoost performance:

- At least 15 vertical feet is needed between the External Antenna (receives the outside signal) and the Indoor Antenna (rebroadcasts the signal indoors). Separation less than 15 vertical feet will result in decreased performance. See illustration below.
- Keep the External Antenna at least 3 feet above any metal.

See “Installing Your zBoost Signal Booster” on page 5, for additional information.

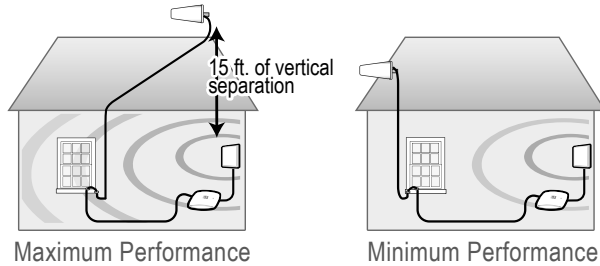

Cable Requirements

RG-6 cable is used to connect the External Antenna and the Base Unit. Should you need additional cable length, 15 foot extensions (Part #: **YX030-15w**) are available at www.zBoost.com.

The total cable length should not exceed 65 feet unless you upgrade the cable to RG-11. (see page v). The recommended maximum length for RG-11 is 100 ft. A longer cable is helpful only if it allows you to place the External Antenna in a location where you measure stronger signal. It is highly recommended that you refrain from securing your cable, drilling any holes, etc. until you complete and test the installation of the system.

Caution: Before drilling any holes into a wall to run your cable, make sure you know where existing electrical wiring is located. Drilling into live electrical wiring could cause an electrical shock and sever the wire.

Grounding the Directional External Antennas

If you decide to place the External Antenna outdoors, it must be properly grounded. (See page v for a recommended grounding kit).

The set up must be in accordance with Article 810 of the National Electric Code (NEC). A listed antenna discharge unit must be provided for the lead-in coaxial cable per NEC article 8.10.20 or the shield of the coaxial cable must be permanently and effectively grounded in accordance with NEC article 8.10.21. Please consult a professional installer or electrician for more information.

Securing Cable with a Drip Loop

When you install the Directional External Antennas, create a drip loop with the coaxial cable at the point where the cable enters the home through an outside wall. This can be done by twisting and securing the cable into a loop (no less than 4” across) near the entry point. This will help prevent moisture from gathering at entry point and leaking into the home.

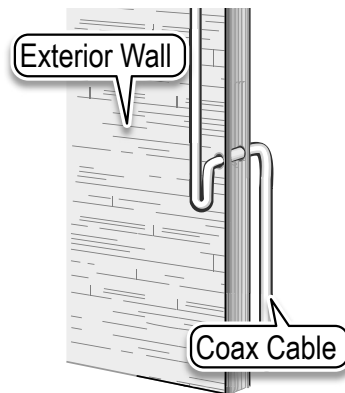

Power Requirements

The Base Unit can be plugged into a standard 2-prong 110 VAC receptacle using the included power supply. The power supply consumes less than 10W (less than 0.2A).

Important Reminders:

An exterior mounting mast has not been provided. Using at least 1.5” PVC pipe or a J-pole (available from zBoost, part YX014) is suggested should one be needed.

Installing Your zBoost Signal Booster

FIRST: Placement of the External Antenna

Choosing the best location for the External Antenna provides the best performance and the largest area of improved signal. Choose a location for the External Antenna using your cell phone to determine the area of strongest signal - typically found outside, above the roofline or in an attic. The antenna must also remain at least 3 feet from any metal objects such as pipes, metal siding, A/C unit etc. and at least 15 vertical feet above the Indoor Antenna.

The YX699 Signal Meter (available separately) provides signal strength information. It can be used with its supplied whip antenna to find the best location for antenna mounting with the strongest received signal. It can also be connected to the directional antenna to aim the antenna for maximum received signal. Contact zBoost to obtain a YX699 Signal Meter.

Mounting of Antenna

1. When you have determined the location of the strongest signal, install the antenna to a mast (not provided). Outdoor J-pole Antenna Mounting Bracket, YX014 is available at www.zBoost.com. Loosely connect the antenna to the mast to allow the antenna to be reoriented for strongest signal. Take special care in aiming the External Antenna in the direction of best signal. If you are unsure of the nearest tower location of your wireless provider, see “Antenna Aiming” on page 7 for detailed instructions.
2. After installing the External Antenna to a mast or pole, connect RG-6 coax cable to the External Antenna and run to the Base Unit.

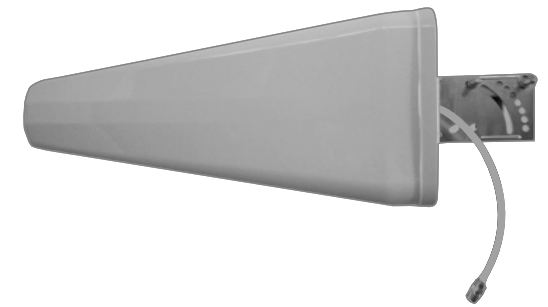
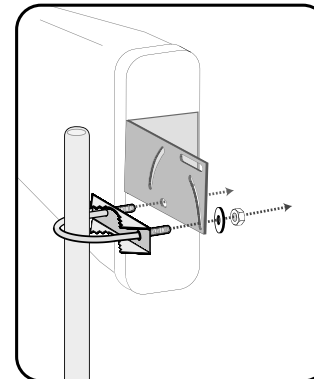

Outdoor External Antenna

NOTE: The zBoost ZB645SL requires at least 15 feet of vertical separation between the Base Unit and the External Antenna. Generally, increasing this distance (up to 40 feet) will increase the performance and decreasing the distance will limit zBoost performance. Keep the Base Unit off the floor and at least 2 feet away from other cords, metal objects or other wireless devices such as wireless routers or wireless access points. The zBoost performs best when there are no obstructions between the zBoost Base Unit and your mobile device.

SECOND: Position Base and Indoor Antenna

The Base Unit can be easily mounted on a wall by first removing the bracket from the Base Unit and using the provided mounting hardware to affix to wall. Connect the Indoor Antenna to the 15 feet of RG-6. Then, using the TNC-F Adaptor, connect the RG-6 to the Base Unit.

The Indoor Antenna should be mounted on a wall facing the direction where increased coverage is desired. Note that signal is broadcast in a beamwidth of 70° horizontally and 60° vertically from the front of the Indoor Antenna. Keep the Indoor Antenna off floor and at least 3 feet away from other cords, metal objects or other wireless devices such as wireless routers or wireless access points. zBoost performs best when there are no obstructions between the Indoor Antenna and your mobile device.

Note: The FCC requires that the panel antenna has a minimum horizontal separation of 6 feet (2 meters) from other CMRS (commercial mobile radio service) devices.

Wall Mounting the Base Unit

The Base Unit can also be easily mounted on a wall. The Base Unit should be a minimum distance of 4-5 feet off from the floor so there is clearance for the Indoor Antenna extension.

Perform the following steps to mount the Base Unit on a wall:

1. Remove the mounting bracket from the Base Unit by slightly spreading the tabs on the mounting bracket.
2. Fasten the mounting bracket to the wall using the self-tapping wall/ceiling anchors.
3. Snap the Base Unit into the mounting bracket.

THIRD: Run the Coaxial Cable

NOTE: Refrain from securing cable or drilling holes until the system has been tested.

The zBoost ZB645SL includes 2 coax cables (35 ft. and 15 ft.) and a window-entry cable for connecting the External Antenna to the Base Unit. If you do not plan to run the cable through a window, the window entry cable is not needed.

To run the coax cable through a window: Connect the two provided RG-6 cables (35 feet & 15 feet) using the provided window-entry cable. Use the attached cables to connect the Base Unit and External Antenna through a window, positioning the window-entry cable at the window closing (See Option 1 on page 9).



Note

Avoid placing the External Antenna near metal such as wiring, A/C ducts, metal siding, truss plates, etc. When connecting the cable to the antenna, run the cable straight down from the antenna. Avoid draping the coax near the antenna.

To run the coax cable through a wall: Connect the two provided RG-6 cables. Then connect one end of the cable to the base of the External Antenna. Run the coaxial cable along a descending pipe or through a wall that leads closest to the location of the Base Unit. Connect the remaining end of the cable to the Base Unit (See Option 2 on page 9).

Should you need additional cable length, 15 foot extensions (Part #: **YX030-15w**) are available at www.zBoost.com. Please note: Cable longer than 65 feet is not recommended.

FOURTH: Connect zBoost Base Unit to Power

Connect the zBoost Base Unit to the power supply and plug into a power outlet. When your zBoost system is in place and fully connected, walk throughout your home and verify that you are able to reliably place calls. If the signal strength has improved, your zBoost is working.

Upon initial power up, the LED will cycle RED, GREEN and ORANGE for 30 seconds. After 30 seconds, a series of GREEN flashes will indicate the quality of your setup. Following this, a solid GREEN light indicates normal conditions. If it is not solid GREEN, follow the instructions in the Base Unit LED Indicators section. Adjustments may be needed to optimize performance. If you find the increased signal coverage is acceptable, however, no additional adjustments are needed. See "Base Unit Light Indicators" on page 11 for more information.

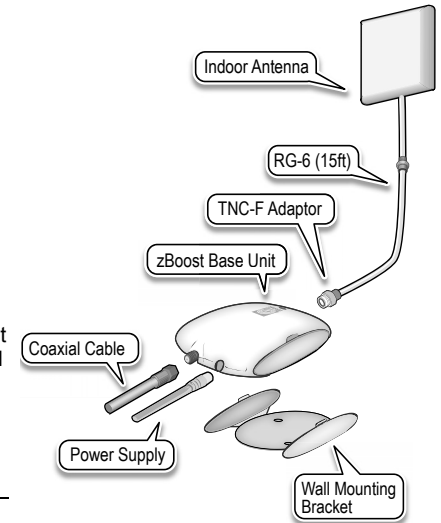

Base Unit Assembly

Antenna Aiming

To get the maximum benefit, you will want to take special care to make sure you point the antenna in the direction of the best signal for your wireless service provider. You may wish to use a YX699 RF signal meter to help during this process or try our zBoost Signal Finder Android App. The majority of the time a cell tower will hold more than 1 frequency band and/or service provider.

To aim the antenna for maximum signal, you will need a phone operating on the same wireless network(s) in use at the install location.

Note: A 1 dBm increase is 25% gain in signal strength.

If you do not know which direction the best signal is coming from, once the unit is installed, rotate the External Antenna in 90 degree increments while measuring the results inside the desired coverage area.

1. Place the cell phone(s) on a non-metal surface about 6-8 feet from the Base Unit.
2. Turn the signal booster on and wait 30 seconds. Note the number of signal bars displayed on your cell phone. For best results, you want to place your phone where the phone's signal meter displays in the middle of the signal meter range or less so that it can indicate as you

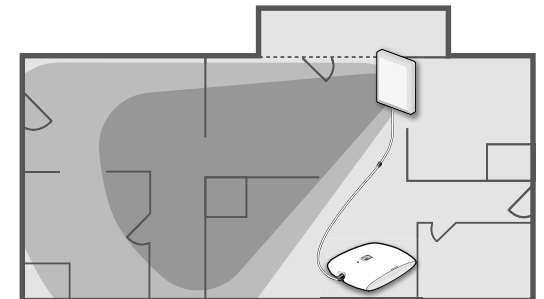

rotate the External Antenna to the optimum direction. If it is reading too high, move the phone farther from the Indoor Antenna. (Note: if you're using signal bars to measure signal strength, turn off your LTE during this process)

3. Record the number of signal bars or dBm _____(A) on your cell phone. You can use our YX699 RF Signal Meter or an application on a smart phone to get the dBm. Leave the phone in exactly the same place and pointing in the same direction for the following steps. Note the direction External Antenna starting position _____.
4. Rotate the External Antenna 90 degrees and then record the phone signal bars _____(B).
5. Continue to rotate the antenna another 90 degrees in the same direction and record the phone signal bars _____(C).
6. Again, rotate the antenna another 90 degrees in the same direction and again record the phone signal bars _____(D).
7. If you desire to optimize further, then look for the two highest signal bar readings above and move the antenna between these two points to find the highest signal bars reading.
8. Look for the highest reading above. Set the antenna to that position and tighten the antenna to the mast of your choosing. We suggest PVC pipe that is at least 1.5" or J-Pole (part # YX014, not included).

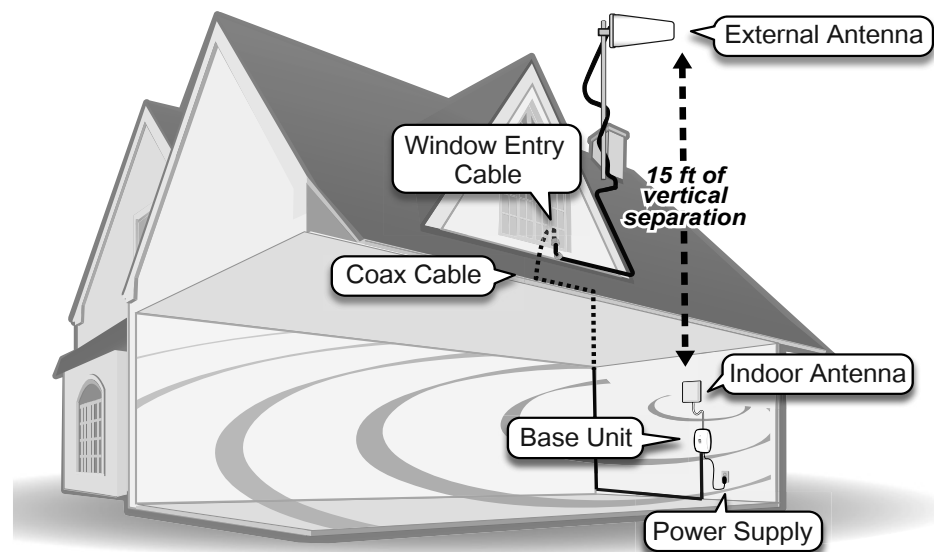

Option 1: Running cable through a window

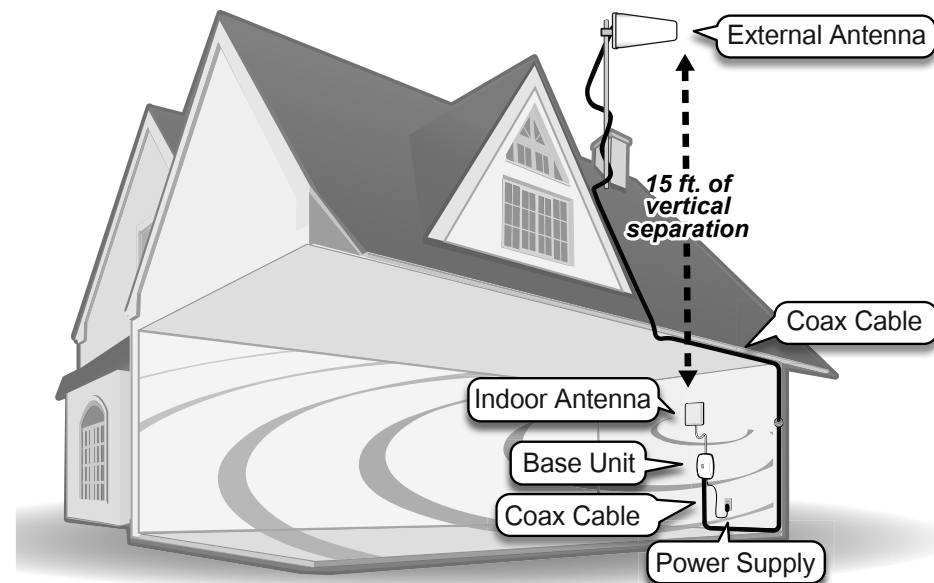

Option 2: Running cable through a wall



Note

Before drilling any holes into a wall to run your cable, make sure you know where existing electrical wiring is located. Drilling into live electrical wiring could cause an electrical shock and sever the wire.

Confirm That Your zBoost is Working Properly

With everything connected and the Base Unit plugged in, you should walk throughout the room and see that you are able to reliably place calls.

Remember, coverage varies based on outdoor signal level, home construction, and general installation care. Coverage in adjoining rooms (next to, above, or below) will be reduced due to the walls or the ceiling/floor.

Improving Your Coverage Area

Should you desire to improve coverage, you may:

1. Move the Base Unit and/or adjust the angle of the Indoor Antenna.
2. Move the External Antenna to a higher location in the attic or outside.
3. Purchase an antenna upgrade at www.zBoost.com.

Note: Using a signal meter or an antenna application on a smartphone is a more accurate way to measure a stronger signal than the bars on a phone.

Upon initial power up, the LED will cycle RED, GREEN and ORANGE for 30 seconds. After 30 seconds, a series of GREEN flashes will indicate the quality of your setup. Following this, a solid GREEN light indicates normal conditions. If it is not solid GREEN, follow the instructions in the Base Unit LED Indicators section. Adjustments may be needed to optimize performance. If you find the increased signal coverage is acceptable, however, no additional adjustments are needed. See “Base Unit Light Indicators” on page 11 for more information.



Note

Cell phone signal bars are approximate and vary from phone to phone. The number of bars can fluctuate widely, depending on the location of the phone, the position or angle of the phone, weather, etc. Most cell phone signal meters update every 6 to 10 seconds. An increase of only one bar typically indicates a 4x to 10x signal increase.

Base Unit Light Indicators

During Initial Power Up

Light Mode	Status	Solution
Cycle RED, GREEN, ORANGE	System is powering up. Please allow up to 30 seconds.	N/A
Flashing GREEN	BASE UNIT will flash GREEN once for every 2 dB less than optimal system gain. Three flashes or less indicates the system will still operate properly.	<ol style="list-style-type: none"> 1. Unplug the BASE UNIT power supply. 2. Relocate the EXTERNAL ANTENNA to pick up the strongest signal from your wireless carrier. 3. Move the EXTERNAL ANTENNA as far away from the INDOOR ANTENNA as possible, with at least 15 ft. of vertical separation (height difference). 4. Plug the BASE UNIT power supply back in. 5. Wait 30 secs. for the BASE UNIT to power cycle on.

Solution #1

After Initial Power Up

Light Mode	Status	Solution
SOLID GREEN	zBoost is ready.	N/A
Flashing GREEN	zBoost is in use.	N/A
SOLID ORANGE	EXTERNAL ANTENNA and INDOOR ANTENNA are too close together.	<ol style="list-style-type: none"> 1. Unplug the BASE UNIT power supply. 2. Move the EXTERNAL ANTENNA as far away from the INDOOR ANTENNA as possible, with at least 15 ft. of vertical separation (height difference). 3. Plug the BASE UNIT power supply back in. 4. Wait 30 secs. for the BASE UNIT to power cycle on.
SOLID RED	Signal from the carrier's cell tower is too strong for the BASE UNIT to operate properly.	<ol style="list-style-type: none"> 1. Unplug the BASE UNIT power supply. 2. Relocate the EXTERNAL ANTENNA to another spot. 3. If you have a directional antenna re-aim it to reduce carrier signal strength. 4. Plug the BASE UNIT power supply back in. 5. Wait 30 secs. for the BASE UNIT to power cycle on.
Flashing RED	Excessive electronic noise in the system – the BASE UNIT will not operate.	^ Refer to Solution #2

Solution #2

Solution #3

Technical Specifications

Product Specifications for zBoost ZB645SL

PCS band	
Frequency	Uplink: 1850 to 1910 MHz Downlink: 1930 to 1990 MHz
System Gain	84 dB
PCS band supported	A, D, B, E, F, C
Networks	CDMA, GSM, GPRS, EDGE, EVDO, 1xRTT, UMTS, HSPA, 3G
Output power	Uplink: 26 dBm; Downlink: 10 dBm

Cellular band	
Frequency	Uplink: 824 to 849 MHz Downlink: 869 to 894 MHz
System Gain	75 dB
CEL band supported	A, B, A', B'
Networks	CDMA, GSM, GPRS, EDGE, EVDO, 1xRTT, UMTS, HSPA, 3G
Output power	Uplink: 28 dBm; Downlink: 8 dBm

General	
Power Consumption	3W standby; 7W max signal - 5.0VDC, 2.0A Max
Wall Supply Input ; Voltage	100-240VAC, 50-60 Hz
Input and Output Impedance	TNC Connector: 50 Ohm; F Connector: 75 Ohm
System Certifications	FCC Parts 15 & 20, Industry Canada
Base Unit Size and Weight	5" x 7" x 1.25" – 9 oz.
Operating Conditions	Indoor Use Only (40° - 105° F)
Coverage area	Up to 10,000 sq. ft.

The Manufacturer's rated output power of this equipment is for single carrier operation. For situations when multiple carrier signals are present, the rating would have to be reduced by 3.5 dB, especially where the output signal is re-radiated and can cause interference to adjacent band users. This power reduction is to be by means of input power or gain reduction and not by an attenuator at the output of the device.

This product is covered by patent US 7,706,744.

Frequently Asked Questions

What can I expect my cell phone signal range and strength to be inside my home?

The closer you are to the base, the stronger the signal. This will vary with different conditions. Some of the conditions that will affect the improved coverage area are signal strength outdoors, the type of building materials in the home, the placement of the unit and the antenna's proximity to cellular towers.

You can expect that your indoor coverage will be improved. You will be able to make calls where you couldn't before. The degree of improvement will depend upon many factors. The intent of zBoost products are to bring outside coverage inside. Just as the signal bars move up and down when outside, the boosted signal will fluctuate in a similar fashion.

Is a cellular phone signal booster the same as a wireless router; will it help my WiFi signal?

The zBoost unit will not help your WiFi service. This unit is designed to work with wireless PCS and Cellular phones and devices. The WIFI in your home operates on a different frequency.

Why isn't my cell phone indicating more signal with more bars?

You may not always observe more bars that gain on your signal meter because of the signal spreading out from the antenna. If your phone has a dB meter, 3 dB is a significant increase of 2x, 6 dB is 4x, and 10 dB is 10x. On a four bar phone, one "bar" equals about 10 dB.

- The increase in signal you will see depends upon:
- The level of signal at the External Antenna (outdoor)
- The care of the antenna placement (two feet away from metal, adequate antenna separation [15 feet recommended])
- The signal already present inside (related to building losses)
- The distance of your phone/device from the Base Unit (signal spreads or diminishes rapidly with distance.)

Also, if your phone uses LTE, it likely displays LTE signal level instead of 3G when a call is being placed.

There are usually several cell phones in use at one time in my home, will your product boost all of our signals simultaneously?

The zBoost ZB645SL is designed to cover multiple signals simultaneously and will allow multiple users to operate at the same time.

Does the zBoost work if you have no bars?

No, if no signal is present outdoors zBoost products will not work for you. Also, keep in mind if your best signal is 1 bar at the External Antenna, your coverage will be limited to one or two rooms.

Where should I put my zBoost base unit to get the best coverage?

You should install your base unit where you need coverage the most. The zBoost base unit is the component that amplifies the signal inside. The coverage is improved in a circular manner from the base unit. The farther you are away from the base unit, the weaker the signal. The base could be placed in the family room, the basement, or a central location.

Note: if you install the External Antenna too close to the Base Unit, the system will shut down (red light will blink). This is a normal condition for this scenario. It just means that you need to ensure

that you have sufficient distance between the 2 antennas; otherwise, it will detect feedback or noise and will automatically shut down.

Where is the best place to put my zBoost External Antenna?

The zBoost External Antenna should be placed at the highest point in your house in order to “catch” the strongest signal. This location could be in the attic or on the roof. The placement of the External Antenna is very important. It is best to place this in an un-obstructed area. If you install it outside, place it above the roof line. Or, this antenna can be placed in the area around your home that has the greatest signal strength.

Note: if you install the External Antenna too close to the Base Unit, the system will shut down (red light will appear). This is a normal condition for this scenario. It just means that you need to ensure that you have proper isolation between the 2 antennas; otherwise, it will detect feedback or noise and will automatically shut down.

My light is continually blinking

There are several reason that the zBoost light could be blinking. Please see the “Base Unit Light Indicators” on page 11 for specific answers.

Does the zBoost work on all 3G data?

No, it only works on data that is on 1900 and 800 MHz frequency like iPhones, but not on smartphones that use 3G on 2100 MHz frequencies.

Warranty Information

Limited 1 Year Warranty

Warranty registration at www.zBoost.com

zBoost warrants every zBoost product to be free from defects in material and workmanship under normal use for the warranty period of one year.

Who Is Covered?

You must have proof of purchase to receive warranty service. A sales receipt or other documentation showing the product purchased and the purchase date is considered proof of purchase. This limited warranty extends only to the original consumer purchaser or any person receiving the product as a gift from the original consumer purchaser and to no other purchaser or transferee.

What is Covered?

Warranty coverage begins the day you purchase the product. For one year from the original date, the zBoost Cell Phone Signal Booster will be repaired or replaced with a new, repaired, refurbished or comparable product (whichever is deemed necessary by zBoost) if it becomes defective or inoperative. The exchange will be made without charge to you for parts and labor. You will be responsible for the cost of shipping to the location designated by zBoost.

All products, including replacement products, are covered only for the original warranty period. When the warranty on the original product expires, the warranty on the replacement product also expires.

What is Excluded?

Your warranty does NOT cover:

- Labor charges for set up of the unit.
- Product replacement because of misuse, accident, lightning damage, unauthorized repair or other cause not within the control of zBoost.
- Incidental or consequential damages resulting from the product. Some states do not allow the exclusion of incidental or consequential damages, so the above exclusion may not apply to you.
- Any modifications or other changes to the product, including but not limited to software or hardware modifications in any way other than as expressly authorized by zBoost will void this limited warranty.
- Product that has been modified or adapted to enable it to operate in any country other than the country for which it was designed, manufactured, approved and/or authorized, or repair of products damaged by these modifications.

Make sure you keep...

Please keep your sales receipt or other document showing proof of purchase. Attach it to this User Manual and keep both nearby. Also, keep the original box and packing material in case you need to return your product.

Before requesting repair service...

If red light is on, system is receiving signals from either the mobile device or the base station transceiver which are too strong for proper operation. Please unplug your system. Re-orient your External Antenna and/or Base Unit to reduce the excessive signal source. Plug your system back in. If still solid red, call customer support 1-800-871-1612.

To get warranty service...

Warranty service will be provided by zBoost. If you believe you need service for your unit, contact zBoost at 1-800-871-1612 or support@zBoost.com. A representative will go through a diagnostic checklist with you. If it is determined that the product needs to be returned for service or exchanged, you will receive a return merchandise authorization (RMA) number. The representative will give you complete shipping details. Do not return products to zBoost without a Return Authorization Number.

To get out of warranty service...

To obtain out of warranty service, contact zBoost at 1-800-871-1612 or support@zBoost.com for information on the possibility of any costs for repair or replacement of out-of-warranty products.

Reminder

Record the model and serial number found on the product below:

Model #: _____

Serial #: _____

Purchase Date: _____