



zBoost® TRIO Xtreme REACH ZB585X Manual

Models:

- ZB585X-A
- ZB585X-V



zBoost® products have a 30-day money back guarantee when purchased directly from zBoost. If product is purchased from a reseller or third party, the purchaser is subject to the policies of the third party.

2 year manufacturer warranty. Warranty registration at www.zBoost.com

FCC Requirements

This is a CONSUMER Device.

BEFORE USE, you MUST REGISTER THIS DEVICE with your wireless provider and have your provider's consent. Most wireless providers consent to the use of signal boosters. AT&T, Sprint, T-Mobile, Verizon and 90 additional have already given consent for all consumers to use this device. Some providers may not consent to the use of this device on their network. If you are unsure, contact your provider.

You MUST operate this device with approved antennas and cables as specified by the manufacturer. Antennas MUST be installed at least 20 cm (8 inches) from any person.

You MUST cease operating this device immediately if requested by the FCC or a licensed wireless service provider.

WARNING. E911 location information may not be provided or may be inaccurate for calls served by using this device.

FCC contact information: www.fcc.gov/signal-boosters/registration

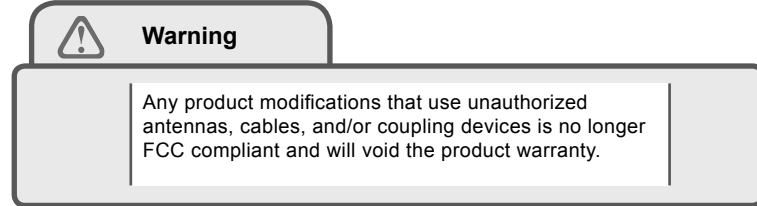

FCC Information

FCC ID: SO4ZB570-TRI-VLTE, SO4ZB570-TRI-ALTE

Warning: Changes or modifications to this device not expressly approved by zBoost could void the user's authority to operate the equipment.

Note: This equipment has been tested and found to comply with the limits for a Class B digital device, pursuant to Part 15 of the FCC Rules. These limits are designed to provide reasonable protection against harmful interference in a residential installation. This equipment generates, uses, and can radiate radio frequency energy and, if not installed and used in accordance with the instructions, may cause harmful interference to radio communications. However, there is no guarantee that interference will not occur in a particular installation. If the equipment does cause harmful interference to radio or television reception, which can be determined by turning the equipment off and on, the user is encouraged to try to correct the interference by one or more of the following measures:

- Reorient or relocate the receiving antenna
- Increase the separation between the equipment and receiver
- Connect the equipment to an outlet on a circuit different from that to which the receiver is connected
- Consult the dealer or www.zBoost.com for an experienced installer

This equipment complies with FCC radiation exposure limits set forth for an uncontrolled environment. This transmitter must not be co-located or operating in conjunction with any other antenna or transmitter. In accordance with FCC requirements of human exposure to radiofrequency fields, the radiating element (antenna) shall be installed such that a minimum separation distance of 20cm (8in) is maintained from all persons. Additionally, the device must not be used above 10 m above ground.

About zBoost®

zBoost, a leader in cell phone signal boosters, manufactures an award-winning line of cell phone signal boosters that enhance the performance of your cell phone, smartphone and wireless data card.

Uses patented technologies and protects the carrier networks.

2-year manufacturer warranty – register your product at www.zBoost.com.

Industry Canada Regulations

IC ID: 5544A-ZB570TRIVLT, 5544A-ZB570TRIALT

This Class B digital apparatus meets all requirements of the Canadian Interference Causing Equipment Regulations. Operation is subject to the following two conditions: (1) this device may not cause harmful interference, and (2) this device must accept any interference received, including interference that may cause undesired operation.

The term "IC:" before the radio certification number only signifies that Industry Canada technical specifications were met.

RF Exposure: The manufacturer's rated output power of this equipment is for single carrier operation. For situations when multiple carrier signals are present, the rating would have to be reduced by 3.5 dB, especially where the output is re-radiated and can cause interference to adjacent band users. This power reduction is to be by means of input power or gain reduction and not by an attenuator at the output of the device.

Cet appareillage numérique de la classe [B] répond à toutes les exigences de l'interférence canadienne causant des règlements d'équipement. L'opération est sujette aux deux conditions suivantes: (1) ce dispositif peut ne pas causer l'interférence nocive, et (2) ce dispositif doit accepter n'importe quelle interférence reçue, y compris l'interférence qui peut causer l'opération peu désirée.

Le fabricant nominale de la puissance de sortie de ce matériel est simple transporteur. Pour les situations lorsque plusieurs signaux porteurs sont présents, l'évaluation devrait être réduite de 3.5 dB, en particulier lorsque le signal de sortie est ré-émission et peut provoquer des interférences adjacentes à la bande utilisateurs. Ce pouvoir est de la réduction par le biais de la sortie d'alimentation ou la réduction de gain et non par un atténuateur à la sortie du dispositif.

Please note: This unit has been approved for use in Canada under RSS 131, however, consent for the use of this device to improve cellular or PCS coverage, must be obtained through your cellular or PCS provider, prior to placing the unit in operation. Please refer to the Industry Canada document CPC 2-1-05, Section 6.1 available or viewable at: <http://www.ic.gc.ca/epic/site/smt-gst.nsf/en/sf08942e.html>

Copyright Notice

This manual is copyrighted. All rights reserved. This manual, whole or in part, may not be copied, photocopied, reproduced, translated or reduced to any electronic medium or machine readable form for distribution. This manual whole or in part, may not be modified without prior consent, in writing, from zBoost.

Copyright © 2014 by zBoost, LLC

Safety and Product Warranty Information

Safety Guidelines

In accordance with FCC requirements of human exposure to radio frequency fields, the radiating element (antenna) shall be positioned such that a minimum separation distance of 8 inches (20cm) is maintained between the radiating element and the user and/or general population.

Limited Liability

In no event shall zBoost be liable for any direct, indirect, special, punitive, incidental, exemplary or consequential damages, or any damages, whether in an action under contract, negligence, or any other theory, arising out of or in connection with the set up of, use of, inability to use, or performance of the information, services, products, and materials available from this manual. These limitations shall apply notwithstanding any failure of essential purpose of any limited remedy. Because some jurisdictions do not allow limitations on how long an implied warranty last, or the exclusion or limitation of liability for consequential or incidental damages, the above limitations may not apply to you. For full warranty guidelines, see page 13.

Package Contents

Before you begin, make sure all of the following parts came with your zBoost TRIO Xtreme REACH:

Literature Contents:

- ① Setup overview for zBoost TRIO Xtreme REACH



Product Contents:

- ② zBoost Base Unit
- ③ Indoor Antenna
- ④ Power Supply
- ⑤ RG-6 Coax Cable (50 ft.)
- ⑥ External Antenna
- ⑦ External Antenna Mounting Hardware

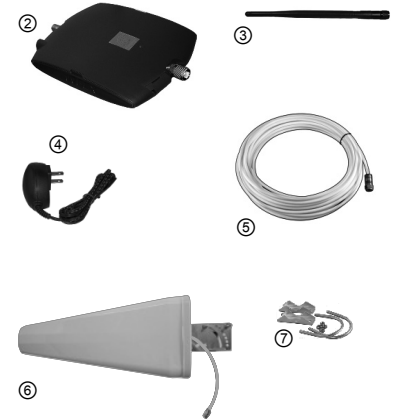

Optional Accessories

The following accessories are authorized for this zBoost product. Please see our website for complete selection. **To order, call 1-800-871-1612, or visit www.zBoost.com.**

Broadcast Antennas - Indoor	
CANT-0039	Indoor Broadcast Antenna, Omni Whip Direct to Booster, Black, Wideband, LTE-CEL-AWS-PCS (1 dBi)
CANT-0045*	Indoor Broadcast Antenna, Wideband Directional Panel, LTE-CEL-AWS-PCS (8 / 7.5 dBi)
YX052	Indoor Broadcast Antenna, Wideband Omnidirectional Ceiling Mount, LTE-CEL-AWS-PCS (1 / 2 dBi)
External Antennas - Outdoor	
CANT-0040	Outdoor External Antenna, Wideband Omni Directional, LTE-CEL-AWS-PCS (3 / 5 dBi)
CANT-0042	Outdoor External Antenna, Wideband Directional Log Periodic, LTE-CEL-AWS-PCS (10 / 12 dBi)
CANT-0043	Window-Mount External Antenna, Wideband Directional Panel, LTE-CEL-AWS-PCS (6 / 7 dBi)
Coax Cable - To be used in addition to the cable included in your kit	
YX030-0W8	8 Inch Window Entry Cable with F-Female Connectors
YX030-15W	15 Foot RG-6 Coaxial Extension Cable with F-Male Connectors
YX030-35W	35 Foot RG-6 Coaxial Extension Cable with F-Male Connectors
YX030-50W	50 Foot RG-6 Coaxial Cable with F-Male Connectors
YX031-100W	100 Foot Low Loss RG-11 Coaxial Cable with F-Male Connectors
Accessories	
YX012	Outdoor External Antenna Grounding Kit

* The FCC requires that this panel antenna has a minimum horizontal separation of 6 feet (2 meters) from other CMRS (commercial mobile radio service) devices.

Table of Contents

FCC Requirements i

FCC Information i

Industry Canada Regulations ii

Copyright Notice ii

Trademarks ii

Safety Guidelines iii

Limited Liability iii

Safety and Product Warranty Information..... iii

Package Contents iv

Optional Accessories v

Table of Contents 1

Overview 2

 Why Indoor Signals Can Be Weak..... 2

Preparing to Set Up Your zBoost Product..... 3

 Tools Needed 3

 Check for External Strength 3

 IMPORTANT: Before Installing, Note These Important Factors in Determining Performance 4

 Grounding the External Antenna..... 4

 Securing Cable with a Drip Loop 5

 Power Requirements..... 5

Setting Up Your zBoost Signal Booster 6

 FIRST: Mount the External Antenna..... 6

 SECOND: Position the Base Unit and Indoor Antenna..... 6

 THIRD: Run the Coaxial Cable between the External Antenna and Base Unit 7

 FOURTH: Connect the zBoost Base Unit to Power..... 7

 FIFTH: Antenna Aiming 8

 Confirm That Your zBoost is Working Properly 9

Improving Your Coverage Area..... 9

zBoost Base Unit Light Indicators..... 10

Technical Specifications 11

Frequently Asked Questions 12

Warranty Information 13

Overview

Thank you for choosing zBoost! You will now be able to use your cell phone **INSIDE** your home. Gone are the days when you had to go to the window upstairs or walk outside to use your cell phone. Like a skylight that brings sunlight into your home, zBoost TRIO transports and amplifies the outdoor 2G/3G and 4G data signal into your home.

Why Indoor Signals Can Be Weak

There are several obstacles that can contribute to the poor reception you receive in your home:

1. Location of the Cell Phone Tower in Relation to Your Home

While cell phone providers have tried to place cell phone towers to provide the best overall coverage, local ordinances and terrain features can impose restrictions on where these towers can be placed, thus, limiting the signal strength available at your location.

2. Obstructions Caused by Buildings, Terrain and Trees

Cell phone signals can be completely blocked or reflected by buildings, walls, trees, hills and other terrain features resulting in low signal strength.

3. Energy Efficient Windows

Energy efficient windows contain a metal film that can affect signal penetration into the house.

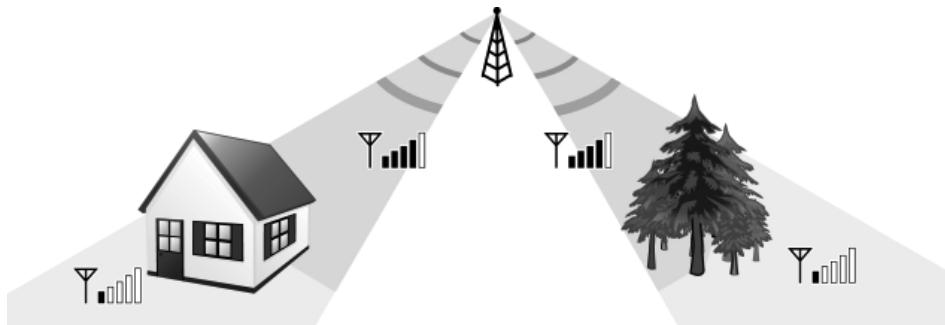

Preparing to Set Up Your zBoost Product

Tools Needed

The following tools are needed to set up your booster:

- #2 Phillips screwdriver
- Cellular phone operating in the band supported by your zBoost unit
- Drill (may be required for outdoor or attic antenna placement)

Check for External Strength

Before placing the unit in your home, make sure that you have reliable signal and fast/reliable data speeds outside your home, in the attic, at roof level or wherever you plan to place the External Antenna. zBoost can only bring signal into your home when it reaches the External Antenna. If there is no signal, zBoost will not work for you.

If a weak signal is available at ground level, check the signal strength in your attic or at roof level location where the signal will likely be stronger and where the External Antenna can be placed for best performance.

If you have reliable, fast data speeds outside your home, then zBoost can bring the signal into your home.



Note



Cell phone signal bars are approximate and vary from phone to phone. The number of bars can fluctuate widely, depending on the location of the phone, the position or angle of the phone, weather, etc. Most cell phone signal meters update every 6 to 10 seconds. An increase of only one bar typically indicates a 4x to 10x signal increase.

IMPORTANT: Before Installing, Note These Important Factors in Determining Performance

1. At least **15 vertical feet** is needed between the *External Antenna* (receives the outside signal) and the *Indoor Antenna* (rebroadcasts the signal indoors). Separation less than 15 vertical feet will result in decreased performance.
If the antennas are too close together, a solid ORANGE light will appear on the Base Unit - see the Base Unit Light Indicators section (page 10). To capture the best signal, place the External Antenna as high as possible.
2. Position the *External Antenna* vertically and keep it at least 3 feet **above** any metal.

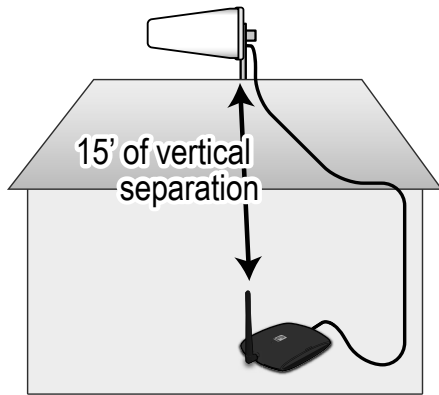

Grounding the External Antenna

If the External Antenna is placed outdoors, it must be properly grounded. (See page v for a recommended grounding kit).

The setup must be in accordance with Article 810 of the National Electric Code (NEC). A listed antenna discharge unit must be provided for the lead-in coaxial cable per NEC article 8.10.20 or the shield of the coaxial cable must be permanently and effectively grounded in accordance with NEC article 8.10.21. Please consult a professional installer or electrician for more information

Securing Cable with a Drip Loop

If the External Antenna is placed outdoors, create a drip loop with the coaxial cable at the point where the cable enters the home through an outside wall. This can be done by twisting and securing the cable into a loop (no less than 4" across) near the entry point. This will help prevent moisture from gathering at entry point and leaking into the home. Consult a professional installer for more information.

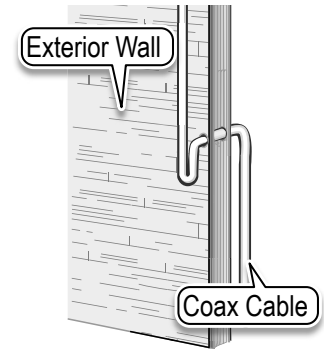

Power Requirements

The Base Unit can be plugged into a standard 2 or 3 prong 110 VAC receptacle using the included power supply. The power supply consumes less than 10W (less than 0.2A). For more information on power consumption, see "Technical Specifications" on page 11.

Warning



The zBoost TRIO Xtreme REACH base unit **MUST** only be used with the provided power adaptor. Use of other power adaptors will void the warranty and may damage the unit. Use of other equipment is not FCC approved.

Setting Up Your zBoost Signal Booster

FIRST: Mount the External Antenna

Choosing the best location for the External Antenna provides the best performance and the largest area of improved signal. Choose a location for the External Antenna using your cell phone to determine the area of strongest signal - typically found outside, above the roofline or in an attic. Keep in mind that if your best signal is one bar, your coverage will be limited to one small room.

Maximum performance will be achieved when the antenna is aimed at the strongest signal from your wireless provider. If you know the direction of your provider's tower, simply point the antenna in that direction. If you are unsure of the location of the nearest tower, loosely secure the antenna to the mounting surface or mast (not provided) to allow adjustment or rotation around mast. Before securing antenna hardware, take care in finding the optimum angle at which to aim the antenna – See *Antenna Aiming* section on page 7 for further instruction.

Once you have determined the optimum location and angle, connect the L-bracket to the antenna and secure the antenna bracket to a mast (not provided) or a flat surface using the provided antenna hardware (see bracket assembly illustration). Ensure that the antenna remains at least 3 feet above any metal objects (such as pipes, metal siding, A/C unit etc.) and parallel to the ground with the two holes on the side of the antenna facing down.

▶ To mount antenna to a pole: Attach bracket end of antenna to pole bracket as pictured. Use U-Bolt to secure bracket to pole and fasten.

▶ To mount antenna to a flat surface: Attach bracket end of antenna desired surface. Secure bracket using provided screws. The of the U-Bolt is not necessary for this option.

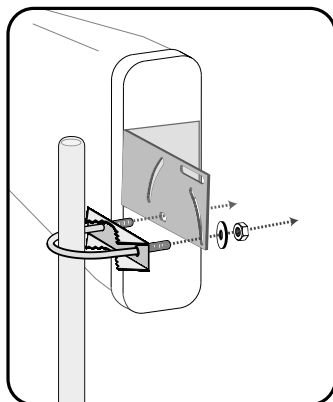

Note

Avoid placing the External Antenna near metal such as wiring, A/C ducts, metal siding, truss plates, etc. When connecting the cable to the antenna, run the cable straight down from the antenna. Avoid draping the coax near the antenna.

SECOND: Position the Base Unit and Indoor Antenna

Connect the Indoor Antenna to the Base Unit. Place the Base Unit and the Indoor Antenna where increased coverage is desired. Keep it 4 - 5 feet from the floor and at least 3 feet away from other cords, metal objects or other wireless devices such as wireless routers or wireless access points. The zBoost TRIO Xtreme REACH performs best when there are no obstructions between the Indoor Antenna and your mobile device.

Wall Mounting the Base Unit (Optional)

The Base Unit should be a minimum distance of 4-5 feet off from the floor so there is clearance for the Indoor Antenna extension.

1. Remove the mounting bracket from the Base Unit by slightly spreading the tabs on the mounting bracket.
2. Fasten the mounting bracket to the wall using the self-tapping wall/ceiling anchors.
3. Snap the Base Unit into the mounting bracket.



zBoost Base Unit Assembly

Remember, the zBoost TRIO Xtreme REACH requires at least 15 feet of vertical separation between the Indoor Antenna and the outdoor External Antenna.

Generally, increasing this distance (up to 40 feet) will increase the performance and decreasing the distance will limit zBoost performance.

THIRD: Run the Coaxial Cable between the External Antenna and Base Unit

Connect one end of the provided 50 feet of RG-6 coax cable to the External Antenna then run the cable to the location in the home where you have installed the Base Unit.

Should you need additional cable length, 15 foot extensions (Part #: YX030-15W) are available at www.zBoost.com. The total cable length should not exceed 65 feet unless you also purchase an upgraded External Antenna or replace your existing cable with our 100 foot RG-11 coax cable (Part# YX031-100W). A longer cable is helpful only if it allows you to place the External Antennas in a location where you measure stronger signal.

It is highly recommended that you refrain from securing your cable, drilling any holes, etc. until you complete and test the installation of the system.

Caution: Before drilling any holes into a wall to run your cable, make sure you know where existing electrical wiring is located. Drilling into live electrical wiring could cause an electrical shock and sever the wire.

FOURTH: Connect the zBoost Base Unit to Power

Connect the zBoost Base Unit to the provided power supply and plug into a power outlet.

Upon initial power up, the LED will cycle RED, GREEN and ORANGE for 30 seconds. After 30 seconds, a series of GREEN flashes will indicate the quality of your setup. Following this, a solid GREEN light indicates normal conditions. If it is not solid GREEN, follow the instructions in the Base Unit LED Indicators section. Adjustments may be needed to optimize performance. If you find the increased signal coverage is acceptable, however, no additional adjustments are needed. See "zBoost Base Unit Light Indicators" on page 10) for more information.

FIFTH: Antenna Aiming

To get the maximum benefit, you will want to take special care to make sure you point the antenna in the direction of the best signal for your wireless service provider. You may wish to use a YX699 RF signal meter to help during this process or try our zBoost Signal Finder Android App. The majority of the time a cell tower will hold more than 1 frequency band and/or service provider.

To aim the antenna for maximum signal, you will need a phone operating on the same wireless network(s) in use at the install location.

Note: A 1 dBm increase is 25% gain in signal strength.

If you do not know which direction the best signal is coming from, once the unit is installed, rotate the External Antenna in 90 degree increments while measuring the results inside the desired coverage area.

1. Place the cell phone(s) on a non-metal surface about 6-8 feet from the Base Unit.
2. Turn the signal booster on and wait 30 seconds. Note the number of signal bars displayed on your cell phone. For best results, you want to place your phone where the phone's signal meter displays in the middle of the signal meter range or less so that it can indicate as you rotate the External Antenna to the optimum direction. If it is reading too high, move the phone farther from the Indoor Antenna.
3. Record the number of signal bars or dBm _____(A) on your cell phone. You can use our YX699 RF Signal Meter or an application on a smart phone to get the dBm. Leave the phone in exactly the same place and pointing in the same direction for the following steps. Note the direction External Antenna starting position _____.
4. Rotate the External Antenna 90 degrees and then record the phone signal bars _____(B).
5. Continue to rotate the antenna another 90 degrees in the same direction and record the phone signal bars _____(C).
6. Again, rotate the antenna another 90 degrees in the same direction and again record the phone signal bars _____(D).

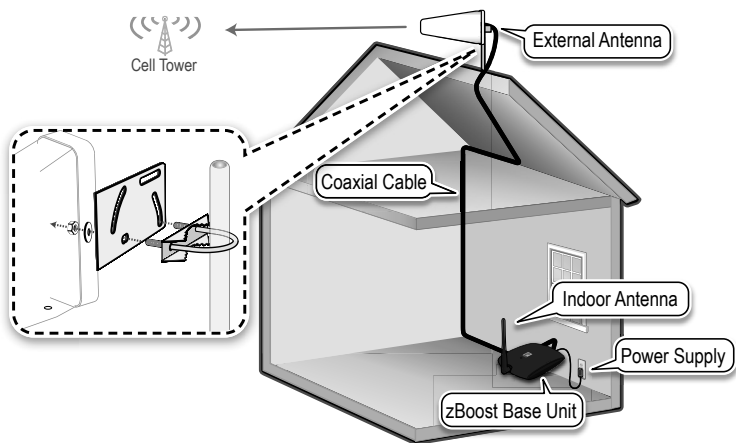

Note ⓘ

Cell phone signal bars are approximate and vary from phone to phone. The number of bars can fluctuate widely, depending on the location of the phone, the position or angle of the phone, weather, etc. Most cell phone signal meters update every 6 to 10 seconds. An increase of only one bar typically indicates a 4x to 10x signal increase.

7. If you desire to optimize further, then look for the two highest signal bar readings above and move the antenna between these two points to find the highest signal bars reading.
8. Look for the highest reading above. Set the antenna to that position and tighten the antenna to the mast of your choosing. We suggest PVC pipe that is at least 1.5" or J-Pole (part # YX014, not included).

Confirm That Your zBoost is Working Properly

When your zBoost system is in place and fully connected, walk throughout your home and verify that you have fast, reliable data speeds. If the signal strength has improved, your zBoost is working. Remember, coverage varies based on outdoor signal level, house construction, and antenna placement. Coverage in adjoining rooms will be reduced by walls and building materials.

Improving Your Coverage Area

Should you desire to improve coverage, you may:

- Relocate the External Antenna in order to capture a better signal –higher is usually better.
- Increase the distance between the Indoor Antenna and the External Antenna.

Keep the Base Unit off the floor and at least 2 feet away from other cords, metal objects or other wireless devices such as wireless routers or wireless access points. The zBoost TRIO Xtreme REACH performs best when there are no obstructions between the zBoost Base Unit and your mobile device.

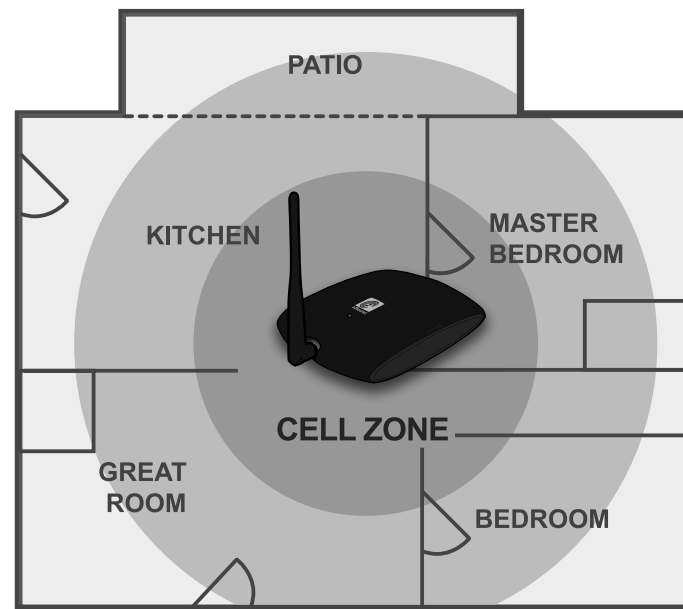

zBoost Base Unit Light Indicators

During Initial Power Up

Light Mode	Status	Solution	
Cycle RED, GREEN, ORANGE	System is powering up. Please allow up to 30 seconds.	N/A	
Flashing GREEN	BASE UNIT will flash GREEN once for every 2 dB less than optimal system gain. Three flashes or less indicates the system will still operate properly.	<ol style="list-style-type: none"> Unplug the BASE UNIT power supply. Relocate the EXTERNAL ANTENNA to pick up the strongest signal from your wireless carrier. Move the EXTERNAL ANTENNA as far away from the INDOOR ANTENNA as possible, with at least 15 ft. of vertical separation (height difference). Plug the BASE UNIT power supply back in. Wait 30 secs. for the BASE UNIT to power cycle on. 	Solution #1

After Initial Power Up

Light Mode	Status	Solution	
SOLID GREEN	zBoost is ready.	N/A	
Flashing GREEN	zBoost is in use.	N/A	
SOLID ORANGE	EXTERNAL ANTENNA and INDOOR ANTENNA are too close together.	<ol style="list-style-type: none"> Unplug the BASE UNIT power supply. Move the EXTERNAL ANTENNA as far away from the INDOOR ANTENNA as possible, with at least 15 ft. of vertical separation (height difference). Plug the BASE UNIT power supply back in. Wait 30 secs. for the BASE UNIT to power cycle on. 	Solution #2
SOLID RED	Signal from the carrier's cell tower is too strong for the BASE UNIT to operate properly.	<ol style="list-style-type: none"> Unplug the BASE UNIT power supply. Relocate the EXTERNAL ANTENNA to another spot. If you have a directional antenna re-aim it to reduce carrier signal strength. Plug the BASE UNIT power supply back in. Wait 30 secs. for the BASE UNIT to power cycle on. 	Solution #3
Flashing RED	Excessive electronic noise in the system – the BASE UNIT will not operate.	^ Refer to Solution #2	

Technical Specifications

Product Specifications for zBoost TRIO Xtreme REACH ZB585X-V

	Verizon LTE	PCS	CEL
Frequency	Uplink: 776—787 MHz Downlink: 746—757 MHz	Uplink: 1850—1910 MHz Downlink: 1930—1990 MHz	Uplink: 824—849 MHz Downlink: 869—894 MHz
Band supported	13	A, D, B, E, F, C	A, B, A', B'
System gain	68 dB	78 dB	69 dB
Output power	3 dBm	4 dBm	3 dBm
Networks	LTE (Verizon)	CDMA, GSM, GPRS, EDGE, EVDO, 1xRTT, UMTS, HSPA, 3G	
General Specifications			
Power Consumption	3W standby; 7W max signal - 2.5A Max		
Wall Supply Input ; Voltage	100-240VAC, 50-60 Hz; 5.0VDC		
Input and Output Impedance	TNC Connector: 50 Ohm; F Connector: 75 Ohm		
System Certifications	FCC Parts 15 & 20, Industry Canada		
Base Unit Size and Weight	5" x 7" x 1.25" – 9 oz.		
Operating Conditions	Indoor Use Only (40° - 105° F)		
Coverage (open areas)	Up to 5,500 sq. ft.		

Product Specifications for zBoost TRIO Xtreme REACH ZB585X-A

	AT&T LTE	PCS	CEL
Frequency	Uplink: 704—716 MHz Downlink: 734—746 MHz	Uplink: 1850—1910 MHz Downlink: 1930—1990 MHz	Uplink: 824—849 MHz Downlink: 869—894 MHz
Band supported	17	A, D, B, E, F, C	A, B, A', B'
System gain	68 dB	78 dB	69 dB
Output power	3 dBm	4 dBm	3 dBm
Networks	LTE (AT&T)	CDMA, GSM, GPRS, EDGE, EVDO, 1xRTT, UMTS, HSPA, 3G	
General Specifications			
Power Consumption	3W standby; 7W max signal - 2.5A Max		
Wall Supply Input ; Voltage	100-240VAC, 50-60 Hz; 5.0VDC		
Input and Output Impedance	TNC Connector: 50 Ohm; F Connector: 75 Ohm		
System Certifications	FCC Parts 15 & 20, Industry Canada		
Base Unit Size and Weight	5" x 7" x 1.25" – 9 oz.		
Operating Conditions	Indoor Use Only (40° - 105° F)		
Coverage (open areas)	Up to 5,500 sq. ft.		

The Manufacturer's rated output power of this equipment is for single carrier operation. For situations when multiple carrier signals are present, the rating would have to be reduced by 3.5 dB, especially where the output signal is re-radiated and can cause interference to adjacent band users. This power reduction is to be by means of input power or gain reduction and not by an attenuator at the output of the device.

This product is covered by patent US 7,706,744. Other U.S. and foreign patents pending.

Frequently Asked Questions

What can I expect my cell phone signal range and strength to be inside my home?

The closer you are to the base, the stronger the signal. This will vary with different conditions. Some of the conditions that will affect the improved data coverage area are signal strength outdoors, the type of building materials in the home, the placement of the unit and the antenna's proximity to cellular towers.

You can expect that your indoor coverage will be improved. You will experience faster, more reliable data where you didn't before. The degree of improvement will depend upon many factors. The intent of zBoost products are to bring outside coverage inside. Just as the signal bars move up and down when outside, the boosted signal will fluctuate in a similar fashion.

Is a cellular phone signal booster the same as a wireless router; will it help my WiFi signal?

The zBoost unit will not help your WiFi service. The WiFi in your home operates on a different frequency.

Why isn't my cell phone indicating more signal with more bars?

You may not always observe more bars on your signal meter because of the signal spreading out from the antenna. If your phone has a dB meter, 3 dB is a significant increase of 2x, 6 dB is 4x, and 10 dB is 10x. On a four bar phone, one "bar" equals about 10 dB.

The increase in signal you will see depends upon:

- The level of signal at the External Antenna (outdoor)
- The care of the antenna placement (two feet away from metal, adequate antenna separation [15 vertical feet of separation is recommended])
- The signal already present inside (related to building losses)
- The distance of your phone/device from the Base Unit (signal spreads or diminishes rapidly with distance.)

There are usually several mobile devices in use at one time in my home, will your product boost all of our signals simultaneously?

The zBoost TRIO Xtreme REACH is designed to cover multiple signals simultaneously and will allow multiple users to operate at the same time.

Does the zBoost work if you have no bars?

No, if no signal is present outdoors zBoost products will not work for you. Also, keep in mind if your best signal is 1 bar at the External Antenna, your coverage will be limited to a small room.

Warranty Information

Limited 2 Year Warranty

Warranty Registration at www.zBoost.com

zBoost warrants this zBoost product to be free from defects in material and workmanship under normal use for the warranty period of two years.

Who Is Covered?

You must have proof of purchase to receive warranty service. A sales receipt or other documentation showing the product purchased and the purchase date is considered proof of purchase. This limited warranty extends only to the original consumer purchaser or any person receiving the product as a gift from the original consumer purchaser and to no other purchaser or transferee.

What is Covered?

Warranty coverage begins the day you purchase the product. For two years from the original date, the zBoost Cell Phone Signal Booster will be repaired or replaced with a new, repaired, refurbished or comparable product (whichever is deemed necessary by zBoost) if it becomes defective or inoperative. The exchange will be made without charge to you for parts and labor. You will be responsible for the cost of shipping to the location designated by zBoost. If zBoost cannot reasonably repair or replace the unit then zBoost may, at its sole discretion, refund the price you paid for the product or the price of the unit.

All products, including replacement products, are covered only for the original warranty period. When the warranty on the original product expires, the warranty on the replacement product also expires.

What is Excluded?

Your warranty does NOT cover:

- Labor charges for set up of the unit.
- Product replacement because of misuse, accident, lightning damage, unauthorized repair or other cause not within the control of zBoost.
- Incidental or consequential damages resulting from the product. Some states do not allow the exclusion of incidental or consequential damages, so the above exclusion may not apply to you.
- Any modifications or other changes to the product, including but not limited to software or hardware modifications in any way other than as expressly authorized by zBoost will void this limited warranty.
- Product that has been modified or adapted to enable it to operate in any country other than the country for which it was designed, manufactured, approved and/or authorized, or repair of products damaged by these modifications.

All zBoost products that are packaged with other zBoost accessory products are intended for resale and use as a single unit, and such product kits are required to be sold to the end user or subsequent reseller as packaged. The "de-kitting" and sale as a standalone product of any one or more components of such a product kit is in violation of zBoost' warranty. No "de-kitted" product will be eligible for return for any reason. The sale of separate, not-kitted cable, antennas and other accessories is allowed and fully warranted

Make sure you keep...

Please keep your sales receipt or other document showing proof of purchase. Also, keep the original box and packing material in case you need to return your product.

Before requesting repair service...

Make sure you have at least 15 feet of vertical separation between External Antenna and Base Unit and that the External Antenna is at least 3 feet above metal.

If red light is on, system is receiving signals from either the mobile device or the base station transceiver which are too strong for proper operation. Please unplug your system. Re-orient your External Antenna and/or Base Unit to reduce the excessive signal source. Plug your system back in. If still solid red, call customer support 1-800-871-1612.

To get warranty service...

Warranty service will be provided by zBoost. If you believe you need service for your unit, contact zBoost at 1-800-871-1612 or support@zBoost.com. A representative will go through a diagnostic checklist with you. If it is determined that the product needs to be returned for service or exchanged, you will receive a return merchandise authorization (RMA) number. The representative will give you complete shipping details. Do not return products to zBoost without a Return Authorization Number.

To get out of warranty service...

To obtain out of warranty service, contact zBoost at 1-800-871-1612 or support@zBoost.com for information on the possibility of any costs for repair or replacement of out-of-warranty products.

Reminder

Record the model and serial number found on the product below:

Model #: _____

Serial #: _____

Purchase Date: _____